

Lenco

USER'S MANUAL

Xemio-656

Media Player



For information and support: www.lenco.com

Warnings

Don'ts

- Do not place naked flames, such as lighted candles on or near the product.
- Do not place objects filled with liquids, such as vases on or near the product.
- Do not use or store this product in a place where it is subject to direct sunlight, heat, excessive dust or vibration.
- Do not use this product with wet hands.
- Do not clean this product with water or other liquids.
- Do not block or cover the slots and holes in the product.
- Do not push foreign objects into the slots or holes in the product.
- Do not attempt to open this product yourself. There are no user serviceable parts inside.
- Do not allow children access to plastic bags.

SAFETY WARNINGS

- Before using this product, read and follow all warnings and instructions.
- This product is not intended for use by young children. Young children should be properly supervised.
- This product is intended for household use only and not for commercial or industrial use.
- Do not expose to dripping or splashing.
- No naked flame sources, such as lighted candles, should be placed on the product.
- Ventilation should not be impeded by covering ventilation openings with items such as newspapers, table cloths, curtains and the like.
- Make sure the unit is adjusted to a stable position. Damage caused by using this product in an unstable position or by failure to follow any other warning or precaution contained within this user manual will not be covered by warranty.

Lenco suggests retaining the packaging in case for future transport of the product.

If at any time in the future you should need to dispose of this product please note that: All batteries and accumulators need to be removed from this product (Removal of Waste Batteries and Accumulators).



WARNING: Prolonged exposure to loud sounds from personal music players may lead to temporary or permanent hearing loss.



WARNING: When participating in the traffic listening to a personal music player can make the listener less aware of potential dangers such as approaching cars.

1. Get to know the controls on Player

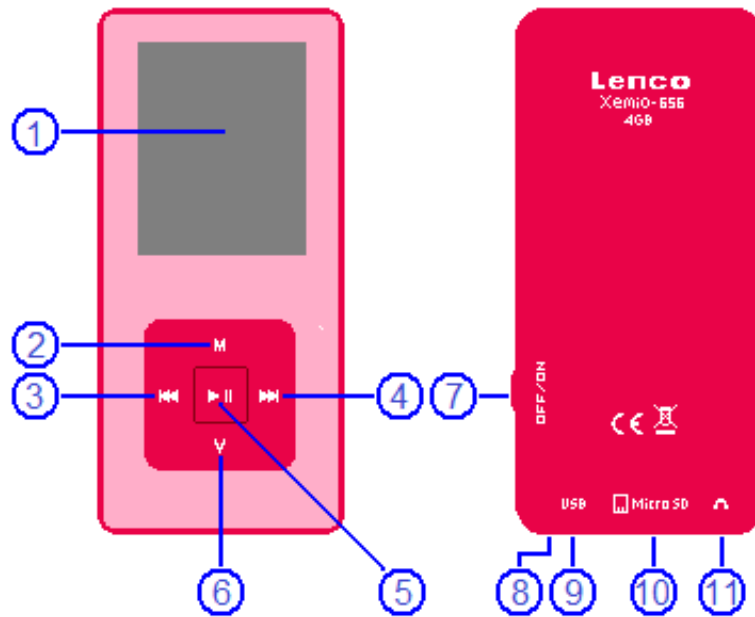

Item	Description
1	TFT LCD Display
2	M Button (Menu / Enter / Select)
3	◀ (◀◀) Button (Previous / Fast-Rewind / VOL-)
4	▶ (▶▶) Button (Next / Fast-Forward / VOL+)
5	Center (▶) Button (Play / Pause / Standby ON - OFF)
6	V (VOL) Button (Volume Control)
7	Main Power Switch (ON - OFF)
8	Microphone (Mono)
9	USB Mini Connector (PC Connection / Charge)
10	Micro SD Memory Card Slot
11	Earphone Output Jack (3.5mm Stereo)

About Player Battery

Player has an internal, non-user-replaceable battery. For best results, the first time you use player, let it charge for about 2 hours or until the battery status icon in the “Connect” screen shows that the battery is in full.



Battery is in full

Note: Player continues to use battery power after it's been turned off, if unit isn't used for a while, the battery might need to be charged.

a. Charging the Battery:

You can charge the player battery in two ways:

- Connect player to your computer. Or,
- Use the USB power charger. (available separately)

b. Connection and Charging:

- Once you have connected player with computer / power charger, then you will see the “Connect” screen appear on screen,
- The level bars are running in battery status icon at the “Connect” screen. The battery is in charging.

“Connect” Screen



In Charging

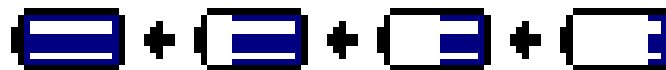

Important: The battery does not charge when your computer is in sleep. The USB port on most keyboards does not provide enough power to charge the player. Connect player to a USB 2.0 port on your computer only to prevent charge problem.

2. Connecting and Disconnecting Player

You can connect the player with your computer to transfer those media files and recorded voice memos when necessary, and to charge the battery. Disconnect the player when you're done.

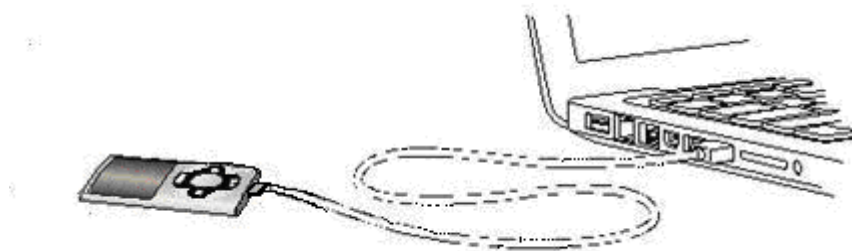

a. To Connecting Player

- To connect player to your computer, plug the connector of USB Cable into a USB port on your

computer, and connect the other end to player, then the “Connect” screen appear for view.

- Now the player is ready for media files transfer with your computer and the battery is charging.
- You can transfer the media files by using the computer mouse use drag and place, or copy and paste, in between the player and your computer. Disconnect it when you’re done.

b. To Disconnecting Player

It’s important not to disconnect player while it’s syncing or transferring files. Eject the player before disconnect it.

- To eject player, press and hold **M** button for about 2 seconds, the “Connect” screen will switch to “Main Menu” screen. And now is safe to disconnect the player with your computer. Unplug the USB cable from the player. Or,
- If you’re using a Windows PC, you can also eject player in My Computer or by clicking the “Safely Remove Hardware” icon in the Windows system tray, select the correspondence name of USB Device and choose “Stop” > choose “Confirm” > choose “Confirm” follow by the pop up windows you’re your computer.
- If you’re using a Mac, you can also eject player by dragging the player icon on the desktop to the Trash.
- Disconnect the USB cable from the player and computer, simply remove it.
- If you accidentally disconnect player without ejecting it, reconnect it to your computer and sync again. However, some media file may loss.

3. Getting Start the Player

Turn ON / OFF the player and use of Main Menu.

- Slide the power switch to “ON” position, then you will see any one of the following shown Main Menu screen, Music / Movie / Record / Voice / Photo / eBook / Game / Setup, will appear on LCD after the Loading and Opening screen have displayed.
- To standby OFF the player, press and hold the **▶||** button for 3 – 4 seconds.
- To turn ON the player again, press and hold the **▶||** button for 3 – 4 seconds again.

“Main Menu” screens

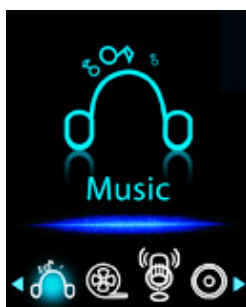

(If Music chooses)



(If Movie chooses)



(If Record chooses)

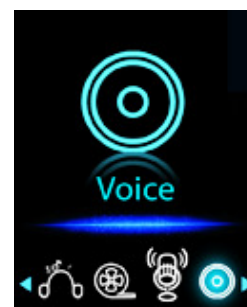

(If Play chooses)



(If Picture chooses) (If Text chooses) (If Game chooses) (If Setting chooses)

4. Use Setup Menu

You might need to set date & time or change some default setting as you desired in setup sub menu before you start to use the player.

- To go into setup menu, from main menu, choose “**Setup**” by use ◀◀ / ▶▶ button and then press **M** button, a “Setting” menu appears to use.
- You can go back to previous menu by press the ▶|| button during in setup menu. Or, press and hold the **M** button to return to main menu.

Setup Menu

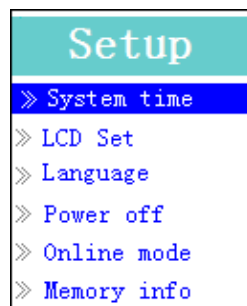

(Menu Page 1)



(Menu Page 2)

a. To Setup “System time” (Date & Time):

- Choose “**System time**” by using ◀◀ / ▶▶ button and then press **M** button, a date & time setting screen appears to use.
- Press “**VOL**” button, the year is highlighted then adjusting to current year by pressing the ◀◀ / ▶▶ button. And repeating the adjusting methods by “**VOL**” and ◀◀ / ▶▶ button again for finished those items; Month, Date, Hour, Minute and seconds setting adjustment.
- Finally, you need to press the **M** button to confirm the adjustment and back to Setup menu, if not the date & time will not to memorize and you need to adjust them again.

Important: Don’t turn OFF the player by the Power Switch if you want to keep the date & time running in background, standby OFF the player by press and hold the ▶|| button in this case. If not, the set date & time will be losses. Adjust the clock again if you want it to use.

b. To change “LCD set”

You can set the backlight to illuminate the screen for a certain amount of time as you desired or make the backlight to always ON when every time you turn ON the player.

- To change LCD backlight, choose “**LCD set**” > choose “**Dark mode**”, a level bar with number appear then chose “0 (always On) / 5 / 10 / 15 / 20 / 25 / 30 / 35 / 40 / 45 / 50 seconds” as you desired by using **M** and **◀◀ / ▶▶** buttons. Choose “0” to prevent the LCD backlight from turning to off. (choosing this option decrease battery performance)

c. To Change “Language”

This player can use difference OSD languages.

- To set the language, choose “**Language**”, and then choose which language as you desired by using **M** and **◀◀ / ▶▶** buttons.

d. To Set “Power Off”

The Power Off setting can extend the time between battery charges by turning OFF the player when you are not using the controls or no operation. Also, Sleep function provided for more choice.

- To set power off time, choose “**Power off**”, then choose “**Off time**”, a levels bar with number menu appear, then choose “0 - 200 seconds” as you want by using **M** and **◀◀ / ▶▶** buttons.
- To set sleep time, choose “**Power off**”, then choose “**Sleep time**”, a levels bar with number menu appear, choose “0 / 10 / 20 / 30 / 40 / 50 / 60 / 70 / 80 / 90 / 100 / 110 / 120 minutes” as you want by using **M** and **◀◀ / ▶▶** buttons.

e. To View “Memory info”

You can view about the memory status of player, such as the numbers of remaining memory space available and the percentage of memory have used.

- To view the status, choose “**Memory info**” by using **M** and **◀◀ / ▶▶** buttons. An information screen, remaining memory space available and percentage of memory used, appear for view.
- To return to setup menu or main menu press **▶||** button or press and hold **M** button

f. To View “Firmware Version”

You might need to view the details about firmware information inside the Player.

- Choose “**Firmware version**” by using **M** and **◀◀ / ▶▶** buttons, an information screen appear for view.
- To return to setup menu or main menu, press **▶||** button or press and hold **M** button.

g. To “Exit”

- Select Exit to back to main menu. Or, press and hold the **M** button to go back main menu.

5. Use Music Menu

You can use music player to playback with supported music file format of audio coding; WMA and MP3 are supported by the player. To open the music player in Main Menu:

- From main menu, choose “**Music**” by using ◀◀ / ▶▶ and **M** button, a “Music Now Playing” screen appears to use.

“Music Now Playing” Screen

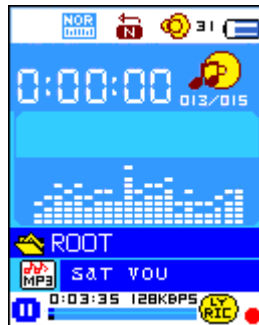

a. To Play Music

- In Music Now Playing screen, press ▶|| button to start the play.
- Press ▶|| button to pause the playing music. Press it again to play.

b. Play Previous or Next Music

- Press ▶▶ button to play next music.
- Press ◀◀ button to play previous music.

c. Use Fast-Forward or Fast-Backward



- Press and hold ▶▶ button to use fast-forward
- Press and hold ◀◀ button to use fast-backward.

d. Adjust volume level

- In music playing , press “**VOL**” button, a change volume control screen appears, then press ◀◀ / ▶▶ buttons to adjust volume levels to down / up.
- Wait for 6 – 8 seconds or press ▶|| button to return to music now playing screen.

For hearing protection; a beep warning will be heard from earphone, or display warning pop-up on TFT screen, when every time you increase the volume level and reach to the default setting level which may exceed 85dB. Press **M** button to accept the warning and enter into the volume control for increase the level and until to maximum level.

e. Use Lyric Display

This player supports “*.LRC” lyric files and lyrics can synchronous displayed while playing music if you music has lyric included. How to know whether the lyrics exist? If the current song has matching lyric files, the color dot beside the Lyric Message icon will be turned to green color  from red  in Music Now Playing screen.

- Playing the music with lyrics, and then press and hold **M** button to enter the lyric display mode and the lyrics is displaying and moving up accordingly with the playing music.
- Press **M** button to cancel the lyrics display and go back to Music Now Play screen if you want.

6. Use Music Submenu in Music Stop Mode

You might need to selecting folders for music play and delete music files. To do this:

a. Local Folder

- In Music Now Playing screen, press ►|| button to stop the playing music if player is in playing, then press **M** button to call up the Music Submenu.
- In Music Submenu screen, choose “**Local folder**” a list menu appear, and then select folder and / or choose a music file by using ◀◀ / ▶▶ and **M** button.
- It will go back to music now playing screen once a music file is selected. Then press ►|| button to play.

b. Delete file

- In Music Submenu screen, choose “**Delete file**” a list menu appear, and then choose which music file that you want to delete by using ◀◀ / ▶▶ and **M** buttons.
- Once file is selected, press **M** button and choose **Yes** to confirm or **No** to cancel.

c. Delete All

- In Music Submenu screen, choose “**Delete all**” then selects “Yes / No” by using ◀◀ / ▶▶ button.
- One “YES” or “NO” appear then press **M** button to confirm.
- All music files will be deleted once YES is selected and confirmed, a “Deleting” screen appear for a while and deleting process is in progress, then “Empty disk!” message will shown on screen for few seconds.

d. Exit

- Select Exit to back to music now playing screen.

7. Use Music Submenu in Music Playing Mode

You might need to do some changes for music playing, such as repeat, EQ settings for music files... etc. To change setting:

a. To Set Repeat

- In music playing mode, press **M** button, a Music Submenu appear, then choose “**Repeat**”, then choose “Normal / Repeat one / Folder / Repeat folder / Repeat all / Random / Intro” as you desired by using ◀◀ / ▶▶ and **M** buttons.

b. To Change Equalizer

- In music playing mode, press **M** button, a Music Submenu appear, the choose “**Equalizer**”, then choose “Natural / Rock / Pop / Classic / Soft / Jazz / DBB” as you desired.

c. Exit

- Select Exit to back to music now playing screen.

8. Use Movie Menu

a. To Play Movie

- From Main Menu, choose “**Movie**” by using ◀◀ / ▶▶ and **M** button, a “Movie Now Playing” screen appears to use.
- In Movie Now Playing” screen, press ▶|| key to start the play.
- Press ▶|| button to pause and to back to Movie Now Playing screen. Press it again, the video will play continue.

b. To Play Previous or Next Video

- Press ▶▶ button to play next movie file.
- Press ◀◀ button to play previous movie file.

c. Use Fast-Forward or Fast-Backward

- Press and hold ▶▶ button to play fast-forward.
- Press and hold ◀◀ button to play fast-backward.

d. Adjust Volume Level

- In movie playing mode, press **VOL** button, then, press ◀◀ / ▶▶ key to decrease or increase the volume levels.
- To preset the volume level at movie stop mode, in Movie Now Playing screen press **VOL** button, a volume control screen appears to use. Then press ◀◀ / ▶▶ key to preset your desired volume levels.

For hearing protection; a beep warning will be heard from earphone, or display warning pop-up on TFT screen, when every time you increase the volume level and reach to the default setting level which may exceed 85dB. Press **M** button to accept the warning and enter into the volume control for increase the level and until to maximum level.

9. Use Movie Submenu

You might need to selecting folders, delete movie files and set repeat for movie play. you can make change during in the playing mode at Movie Now playing screen To do this:

- In “Movie Now Playing” screen, press **M** button to enter to movie submenu.

a. Local Folder

- In movie submenu screen, choose “**Local Folder**”, a file list menu appear, and then select folder and / or choose a desired movie file to play by using ◀◀ / ▶▶ and **M** button.
- It will go back to music now playing screen once a music file is selected. Then press ▶|| button to play.

b. Delete File

- In movie submenu screen, choose “**Delete file**” a file list menu appear, and then choose which movie file that you want to delete by using ◀◀ / ▶▶ buttons.
- Once file is selected, press **M** button and choose “Yes” to confirm or “No” to cancel.

c. Delete All

- In movie submenu screen, choose “**Delete all**” then selects “Yes / No” by using ◀◀ / ▶▶ button.
- One “YES” or “NO” appear then press **M** button to confirm.
- All music files will be deleted once YES is selected and confirmed, a “Deleting” screen appear for a while and deleting process is in progress, then “Empty disk!” message will shown on screen for few seconds.

d. Repeat

- In movie submenu, choose “**Repeat**”, then choose “Normal / Repeat one / Folder / Repeat folder / Repeat all / Random / Intro” as you desired by using ◀◀ / ▶▶ and **M** buttons.

e. Exit

- Select Exit to back to music now playing screen.



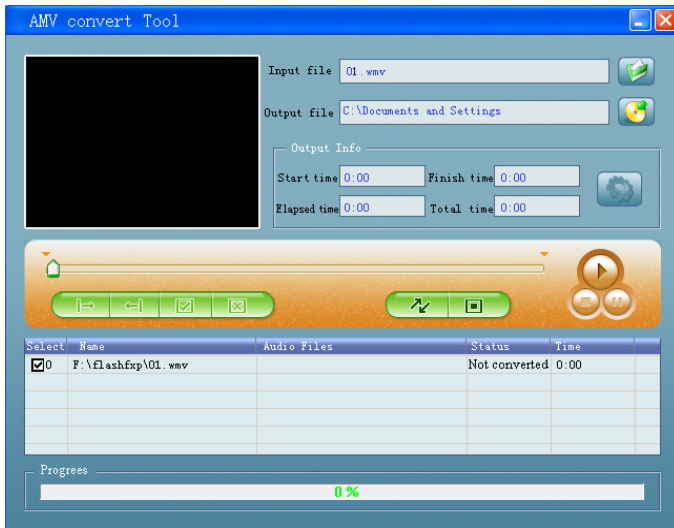

10. Convert Video files into AMV

This tool can be used to transform those video files into AMV files on the computer before you upload them to you player.

- To install this video convert tool to you computer, click “convert tools” in provided CD. (or stored in your Player)
- Select “Setup” to start the install program, the software will automatically install to you computer.
- After installation is done, open AMV converter tool on the PC



Noted: This program is used to convert video files into AMV format, currently only AMV format is supported.

- Run “AMV Convert Tools”, click  to choose the folder where to save the AMV files, and then click  to select the folder where the original files are. The original file will show in the file window once selected.
- Select with highlight the unprocessed AMV files in the file window, the  icon will be highlighted into . And then click  icon and a dialog box will be shown.

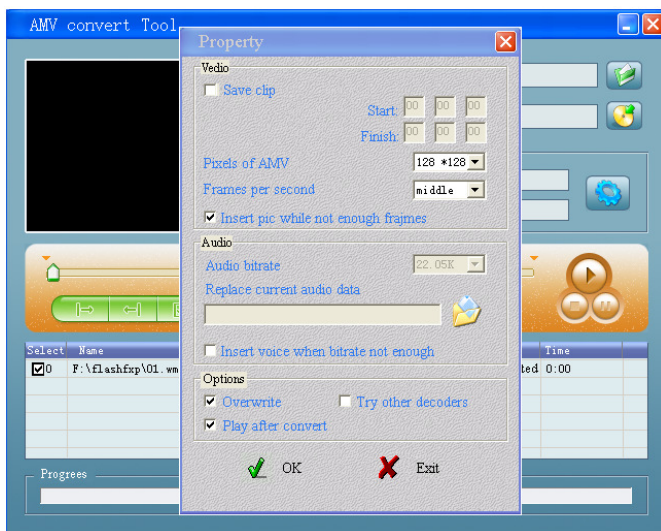

- Choosing pixels of AMV to “160x128” and Frames per second to “middle”, then click OK to confirm.
- Click  to start converting.

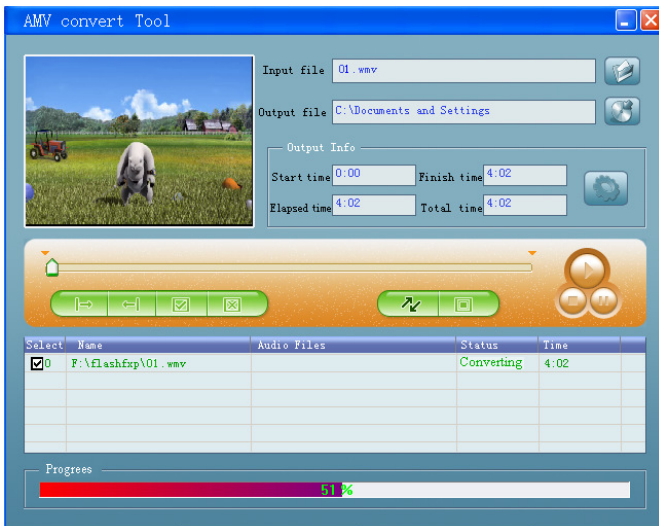

- After conversion, the AMV files will play automatically for preview.
- And now the converted AMV file is ready to transfer, you can simply copy and place those converted AMV files to the media player.

Note: Only pixels in **160x128** can be supported.

11. Use Record Menu

You can use the player as a Voice Recorder and recording voice memos using the built-in microphone.

1. To Start Recording Voice Memo

- From main menu, choose “**Record**” by using ◀◀ / ▶▶ and M buttons, a “Now Recording” screen appear to use.

“Now Recording” Screen



2. To Start / Pause Recording

- Press ▶|| button to start the recording and the recording time is running.
- Press ▶|| button to pause the recording and recording time will stop and flashing. Press it again the recording and time will run continue.

3. To Save and Stop Recording File

- Press and hold **M** button, the recorded file will save into memory.

12. Use Record Submenu (in Stop Mode)

You might need to change the folder locations which want to store the record file and / or change record quality to better compression values.

- In Now Recording screen at stop mode, press **M** button, a “Record Sub-menu appear to use.
 - Local folder**
 - In record submenu, choose “**Local folder**” and then choose the folder name which you want to save the record file by using **◀◀ / ▶▶** and **M** buttons.
 - Once folder name selected, press and hold the **M** button, then the folder location is changed and go back to Now Recording screen.
 - And now you can see the folder name is changed at the Record Folder icon in “Now Recording” screen.
 - Record Type**
 - In record submenu, choose “**Record type**”, then choose “32K BPS / 64K BPS / 128K BPS / 256K BPS” values as you desired by using **◀◀ / ▶▶** and **M** buttons.

13. Use Voice Menu

For playback and manage the recorded voice memos file.

- From main menu, choose “**Voice**” menu by using **◀◀ / ▶▶** and **M** buttons, a “Voice Now Playing” screen appear to use.

“Voice Now Playing” Screen

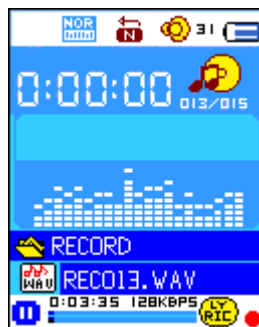

- To Play and Pause Recorded Voice Memos**
 - In Voice Now Playing screen, press **▶||** button to start to play the recorded file.
 - Press **▶||** button to pause the playing file.
- To Play Previous or Next File**
 - Press **▶▶** button to play next file.
 - Press **◀◀** button to play previous file.

c. To Fast-Forward or Fast-Backward

Press and hold ►►| buttons to use fast-forward

Press and hold ◀◀| button to use fast-backward.

d. Adjust volume level

- In music playing , press “VOL” button, a change volume control screen appears, then press ◀◀ / ►►| buttons to adjust volume levels to down / up.
- Wait for 6 – 8 seconds or press ►|| button to return to music now playing screen.

14. Use Voice Submenu in Stop Mode

You might need to change some setting as you desired for playing Voice file, you can make change during in the playing mode at Voice Now Playing screen

a. Local Folder

- In Voice Now Playing screen, press ►|| button to pause / stop the playing file, if in playing mode, then press **M** button to call up the voice submenu.
- In Voice submenu screen, choose “**Local folder**” a list menu appear, and then select folder and / or choose a voice file by using ◀◀ / ►►| and **M** button.
- It will go back to music now playing screen once a music file is selected. Then press ►|| button to play.

b. Delete File

- In voice submenu screen, choose “**Delete file**” a list menu appear, and then choose which voice file that you want to delete by using ◀◀ / ►►| and **M** buttons.
- Once file is selected, press **M** button and choose **Yes** to confirm or **No** to cancel.

c. Delete All

- In voice sub-menu screen, choose “**Delete all**” then selects “Yes / No” by using ◀◀ / ►►| button.
- One “YES” or “NO” appear then press **M** button to confirm.
- All music files will be deleted once YES is selected and confirmed, a “Deleting” screen appear for a while and deleting process is in progress, then “Empty disk!” message will shown on screen for few seconds.

d. Exit

- Select Exit to back to music now playing screen.

15. Use Voice Sub-menu in Playing Mode

You might need to do some changes for music playing, such as repeat, EQ settings for music

files... etc. To change setting:

a. Repeat

- In voice playing mode, press **M** button, a Music Sub-menu appear, then choose “**Repeat**”, then choose “Normal / Repeat one / Folder / Repeat folder / Repeat all / Random / Intro” as you desired by using ◀◀ / ▶▶ and **M** buttons.

b. Exit

- Select Exit to back to music now playing screen.

Note: Press and hold the **M** button will go back to Main Menu directly.

16. Use Photo Browse

You can use the player as picture / photo viewer:

- To browse picture / photo file, from main menu choose “**Photo**” by using ◀◀ / ▶▶ and **M** button, a list menu appear to use.
- Choose a file by using ◀◀ / ▶▶ button, and then press ▶|| button to play.
- Press ▶|| button to stop and to go back to list menu for other files selection.
- To change previous / next photo, press ◀◀ / ▶▶ button.
- Press and hold **M** button to back to main menu.

17. Use Photo Submenu in List Screen

You might need to change some setting for photo browse. To change setting:

a. Local Folder

- In list menu, press **M** button to call up the photo submenu.
- In photo submenu, choose “**Local folder**” a list menu appear, and then choose folder and file to browse by using ◀◀ / ▶▶ and **M** button.
- Once photo file is selected, press ▶|| button to play.

b. Playback Set

- In photo submenu, choose “**Playback set**” and then choose “Manual play”. However, you need to use ◀◀ / ▶▶ button to browse next / previous photo in photo playing mode when Manual Play is selected.
- Choose “Auto play”, a setting menu appear, then choose “2 / 3 / 4 / 5 / 5 / 6 / 7 / 8 / 9 / 10 second(s)” as you desired by using ◀◀ / ▶▶ and **M** buttons. The slide show function is activated as your selected time gap to playing the photo files one by one automatically.

c. Delete file

- In photo submenu, choose “**Delete file**” a list menu appear, and then choose which photo file that you want to delete by using ◀◀ / ▶▶ button.

- Once file is selected, press **M** button and choose Yes to confirm or No to cancel.

d. **Delete All**

- In photo submenu, choose “**Delete all**” then selects “Yes / No” by using ◀◀ / ▶▶ button.
- One “YES” or “NO” appear then press **M** button to confirm.
- All photo files will be deleted once YES is selected and confirmed, a “Deleting” screen appear for a while and deleting process is in progress, then “Empty disk!” message will shown on screen for few seconds.

e. **Exit**

- Select **Exit** for back to photo browse list menu screen.

18. **Use eBook Menu**

You can use the player as a text reader with supported file format (.TXT).

a. **To open eBook**

- From main menu, choose “**eBook**” by using ◀◀ / ▶▶ and **M** buttons. A list menu appears to use.
- Choose a file which you want to read by using ◀◀ / ▶▶ button, and then press ▶|| button to play.
- Press ▶▶ button to change next page,
- Press ◀◀ button to go back to previous page,
- Back to list menu screen, press ▶|| button.
- Go back to main menu, press and hold **M** button

19. **Us eBook Submenu in list menu screen**

You might need to change some setting for eBook reading. To change setting:

a. **Local Folder**

- In eBook list menu screen, press **M** button to call up the eBook Submenu.
- In eBook Submenu, choose “**Local folder**” a list menu appear, and then choose folder and file by using ◀◀ / ▶▶ button.
- Once file is selected, press **M** button then ▶|| button to read.

b. **Playback Set**

- In eBook Submenu, choose “**Playback set**” and then choose “**Manual play**”. You need to use ◀◀ / ▶▶ button to change next / previous page for reading when Manual Play is selected. Or,
- Choose “**Auto play**”, a setting menu appears, then choose “1 / 2 / 3 / 4 / 5 / 5 / 6 / 7 / 8 / 9 / 10 second(s)” as you desired by using ◀◀ / ▶▶ and **M** buttons. The Page Flip function is

activated as your selected time gap to playing.

c. Delete file

- In eBook Submenu, choose “**Delete file**” a list menu appear, and then choose which eBook file that you want to delete by using ◀◀ / ▶▶ button.
- Once file is selected, press **M** button and choose **Yes** to confirm or **No** to cancel.

d. Delete All

- In eBook Submenu, choose “**Delete all**” then selects “Yes / No” by using ◀◀ / ▶▶ button.
- One “YES” or “NO” appear then press **M** button to confirm.
- All eBook files will be deleted once YES is selected and confirmed, a “Deleing” screen appear for a while and deleting process is in progress, then “Empty disk!” message will shown on screen for few seconds.

e. Exit

- Select Exit for back to eBook list menu screen.

20. Us eBook Submenu in Playing Mode

You might need to add, select and delete some bookmark when you reading, to do this:

a. Bookmark Select

- In eBook playing mode, choose “**Bookmark select**” by using ◀◀ / ▶▶ and **M** button.
- Choose a stored bookmark which you want to call and then press **M** button to play.

b. Bookmark Delete

- In eBook playing mode, choose “**Bookmark delete**” a list menu appears, and then choose which saved bookmark you want to delete by using ◀◀ / ▶▶ button.
- Once bookmark is selected, press **M** button to confirm. The bookmark is deleted and go back to current reading play.

c. Bookmark Add

- In eBook playing mode, select the reading page you want to bookmark, press **M** button to call up eBook submenu.
- Choose “**Bookmark Add**” by using ◀◀ / ▶▶ button and then press **M** button, the pages is saved into bookmark and go back to current reading page automatically.

d. Exit

- Select Exit for back to eBook list menu screen.

21. Use Memory Card Slot

This player allows you to play those support media files from your memory card (T-Flash). Also it

will increase the mobile hard disk memory capacity of the player if you use this option.

a. To Play From Memory Card:

- Turn Off the player. Now insert your Micro SD memory card into the memory card slot on side of player.
- Turn On the player and now the Micro SD memory card, T-Flash, is ready to use.
- The “Card folder” item will be existed to use when you enter into those music, movie, photo, , Record, Voice and eBook submenu.
- Go into the card folder and choose you desired folder(s) and file(s) to play.
- To take out the Micro SD memory card, turn Off the player.

22. Use Game Menu

There have a game name “Snake”. Control the snake move up, down, left and right to eat the food (dot) which will exist somewhere on TFT screen. The snake’s body will get longer at every eats for food, but don’t let the snake hit the walls and hit the snake body.

- To play game, from Main menu, choose “Game” menu, then choose a game to play.
- Control KEY instruction; Press: ◀◀ : left, ▶▶ : right, VOL: Up, M : up, ▶|| : Pause.
- Press and hold M button to exit the game.

23. Trouble Shooting

Unit cannot turn ON	<ul style="list-style-type: none"> * Check whether Power is slide to ON. * Check battery is it charged with enough energy.
No sound is heard from headphone.	<ul style="list-style-type: none"> * Check whether Volume is set “0” and connect the headphone plugs firmly. * Check whether the headphone plug is dirty. * Corrupted MP3 may make a static noise and the sound may cut off. Make sure that the music files are not corrupted.
Characters in LCD are corrupted	<ul style="list-style-type: none"> * Check whether the right language has been selected.
Download of music files fails.	<ul style="list-style-type: none"> * Check whether USB cable is damaged and is connected properly. * Check whether driver is installed correctly. * Check whether the player’s memory is in full.

24. Specification

Dimension	90 mm (H) x 43 mm (W) x 7.8mm (D)	
Weight	27g	
LCD	1.8 inches, Resolution (RGB)128 x 160	
PC connection	USB 2.0	
Earphone Impedance	32 Ohm	
Internal Memory	See carton or giftbox	
Battery	Li-ion 3.7V, 150mAh	
	Max. Play Time: > 7 - 9 Hours (MP3 music with power saving mode)	
Audio	Max. Output Power of Earphone	L = 275mV(rms) +/-10% at 32 Ohm R = 275mV(rms) +/-10%at 32 Ohm
	Frequency Responses	20Hz to 20000Hz
	SNR	> 70dB
Music Format	MP3 / WMA	32Kbps – 320kbps
Movie Format	AMV	160x128 (max.)
Recorder Coding	WAV	32 / 64 / 128 / 256kbps
Picture Format	JPEG / BMP / GIF	
eBook Format	TXT	
Operating Temperature	0 to 40°C	
Operating System	Window 2000/XP/Vista/Win7, Mac 9.2 or Higher	

25. Disclaimer

Updates to Firmware and/or hardware components are made regularly. Therefore some of the instruction, specifications and pictures in this documentation may differ slightly from your particular situation. All items described in this guide for illustration purposes only and may not apply to particular situation. No legal right or entitlements may be obtained from the description made in this manual

26. Service and support

For information: www.lenco.com

For support: <http://lencosupport.zendesk.com>

Lenco helpdesk:

Germany 0900-1520530 (Local charges)

The Netherlands 0900-23553626 (Local charges + 1ct p/min)

Belgium 02-6200115 (Local charges)

France 03-81484280 (Local charges)

The helpdesk is accessible from Monday till Friday from 9 AM till 6 PM.

When contacting Lenco, you will always be asked for the model and serial number of your product.

The serial number can be found on the back of the device. Please write down the serial number below:

Model: XEMIO-656

Serial number: _____

Lenco offers service and warranty in accordance to European law, which means that in case of repairs (both during and after the warranty period) you should contact your local dealer.

Important note: It is not possible to send products that need repairs to Lenco directly.

Important note: If this unit is opened or accessed by a non-official service center in any way, the warranty expires.

This device is not suitable for professional use. In case of professional use, all warranty obligations of the manufacturer will be voided.

27. CE



Products with the CE marking comply with the EMC Directive (2004/108/EC) and the Low Voltage Directive (2006/95/EC) issued by the Commission of the European Community.

The declaration of conformity may be consulted at

<http://www.lenco.eu/supportfiles/CE/fvnf8gbhegf899g.pdf>

28. Recycle



This symbol indicates that the relevant electrical product or battery should not be disposed of as general household waste in Europe. To ensure the correct waste treatment of the product and battery, please dispose them in accordance to any applicable local laws of requirement for disposal of electrical equipment or batteries. In so doing, you will help to conserve natural resources and improve standards of environmental protection in treatment and disposal of electrical waste (Waste Electrical and Electronic Equipment Directive).

®All rights reserved