

FLUKE®

789

ProcessMeter™

Users Manual

August 2002 Rev. 3, 3/13

© 2002-2013 Fluke Corporation, All rights reserved. Specifications are subject to change without notice.
All product names are trademarks of their respective companies.

LIMITED WARRANTY AND LIMITATION OF LIABILITY

This Fluke product will be free from defects in material and workmanship for three years from the date of purchase. This warranty does not cover fuses, disposable batteries, or damage from accident, neglect, misuse, alteration, contamination, or abnormal conditions of operation or handling. Resellers are not authorized to extend any other warranty on Fluke's behalf. To obtain service during the warranty period, contact your nearest Fluke authorized service center to obtain return authorization information, then send the product to that Service Center with a description of the problem.

THIS WARRANTY IS YOUR ONLY REMEDY. NO OTHER WARRANTIES, SUCH AS FITNESS FOR A PARTICULAR PURPOSE, ARE EXPRESSED OR IMPLIED. FLUKE IS NOT LIABLE FOR ANY SPECIAL, INDIRECT, INCIDENTAL OR CONSEQUENTIAL DAMAGES OR LOSSES, ARISING FROM ANY CAUSE OR THEORY. Since some states or countries do not allow the exclusion or limitation of an implied warranty or of incidental or consequential damages, this limitation of liability may not apply to you.

Fluke Corporation
P.O. Box 9090
Everett, WA 98206-9090
U.S.A.

Fluke Europe B.V.
P.O. Box 1186
5602 BD Eindhoven
The Netherlands

Table of Contents

Title	Page
Introduction	1
How to Contact Fluke	1
Safety Information	2
How to Get Started	5
Getting Acquainted with the Meter	6
Measuring Electrical Parameters.....	18
Input Impedance.....	18
Ranges	18
Testing Diodes.....	18
Displaying Minimum, Maximum, and Average.....	19
Using AutoHold.....	19
Compensating for Test Lead Resistance.....	20
Using the Current Output Functions	20
Source Mode	20
Simulate Mode.....	22
Producing a Steady mA Output	24
Manually Stepping the mA Output	25
Auto Ramping the mA Output.....	26

Power-Up Options	27
Loop Power Supply Mode.....	29
Battery Life.....	31
Maintenance	31
General Maintenance.....	31
Calibration.....	31
Replacing a Fuse	34
If the Meter does not Work.....	34
Replacement Parts and Accessories	35
Specifications.....	39

List of Tables

Table	Title	Page
1.	International Symbols	4
2.	Input/Output Jacks	7
3.	Rotary Function Switch Positions for Measurements	9
4.	Rotary Function Switch Positions for mA Output	11
5.	Rotary Function Switch Position for Loop Supply	11
6.	Pushbuttons	13
7.	Display	16
8.	mA Output Adjust Pushbuttons	25
9.	mA Stepping Pushbuttons	26
10.	mA Step Values	26
11.	Power-Up Options	28
12.	Typical Alkaline Battery Life	31
13.	Replacement Parts	37

List of Figures

Figure	Title	Page
1.	Fluke 789 ProcessMeter.....	5
2.	Input/Output Jacks.....	6
3.	Rotary Function Switch Positions for Measurements	8
4.	Rotary Function Switch Positions for mA Output.....	10
5.	Pushbuttons	12
6.	Elements of the Display.....	15
7.	Sourcing Current	21
8.	Simulating a Transmitter.....	23
9.	Loop Power Voltage vs. Current.....	29
10.	Connections for Supplying Loop Power.....	30
11.	Replacing the Batteries and Fuses.....	33
12.	Replacement Parts	36

ProcessMeter™

Introduction

Warning

Read “Safety Information” before using the meter.

The Fluke 789 ProcessMeter™ (referred to as “the meter”) is a handheld, battery-operated tool for measuring electrical parameters, supplying steady or ramping current to test process instruments, and providing a > 24 V loop power supply. It has all the features of a digital multimeter, plus current output capability.

If the meter is damaged or something is missing, contact the place of purchase immediately. Contact a Fluke distributor for information about DMM (digital multimeter) accessories. To order replacement parts or spares, see Table 13 near the end of this manual.

How to Contact Fluke

To contact Fluke, call one of the following telephone numbers:

- Technical Support USA: 1-800-44-FLUKE (1-800-443-5853)
- Calibration/Repair USA: 1-888-99-FLUKE (1-888-993-5853)
- Canada: 1-800-36-FLUKE (1-800-363-5853)
- Europe: +31 402-675-200
- Japan: +81-3-6714-3114
- Singapore: +65-6799-5566
- Anywhere in the world: +1-425-446-5500

Or, visit Fluke's website at www.fluke.com.

To register your product, visit <http://register.fluke.com>.

To view, print, or download the latest manual supplement, visit <http://us.fluke.com/usen/support/manuals>.

Safety Information

A **Warning** identifies conditions and procedures that are dangerous to the user. A **Caution** identifies conditions and procedures that can cause damage to the Product or the equipment under test.

International symbols used on the meter and in this manual are explained in Table 1.















Warning

To prevent possible electrical shock, fire, or personal injury:

- Read “Safety Information” before using the meter.
- Do not use the meter if it is damaged. Before using the meter, inspect the case. Look for cracks or missing plastic. Pay particular attention to the insulation surrounding the connectors.
- Make sure the battery door is closed and latched before operating the meter.
- Remove test leads from the meter before opening the battery door.
- Inspect the test leads for damaged insulation or exposed metal. Check test lead continuity. Replace damaged test leads before using the meter.
- Do not use the meter if it operates abnormally. Protection may be impaired. When in doubt, have the meter serviced.
- Do not operate the meter around explosive gas, vapor, or dust.
- Do not use in a damp or wet environment.
- Use only type AA batteries, properly installed in the meter case, to power the meter.
- When servicing the meter, use only specified replacement parts.
- Use caution when working above 30 V ac rms, 42 V ac pk, or 60 V dc. Such voltages pose a shock hazard.
- When using the probes, keep fingers behind the finger guards on the probes.
- Connect the common test lead before connecting the live test lead. When disconnecting test leads, disconnect the live test lead first.

- Do not use AutoHold to determine if dangerous voltage is present. AutoHold will not capture unstable or noisy readings.
- To avoid false readings, which could lead to possible electric shock or personal injury, replace the battery as soon as the battery indicator (🔋) appears.
- Remove test leads from the meter before opening the battery door.
- Close and latch the battery door before using the meter.
- To avoid personal injury or damage to the meter, use only the specified replacement fuse, 440 mA 1000 V fast-blow, Fluke PN 943121.
- Do not exceed the Measurement Category (CAT) rating of the lowest rated individual component of a product, probe, or accessory.
- Do not use the TL175 or TP175 test probes in CAT III or CAT IV environments without the probe tip fully extended and correct category rating visible in the window.
- When the TL175 is used with instruments or other accessories, the lowest category rating of the combination applies. One exception is when the probe is used with the AC172 or AC175.

Table 1. International Symbols

Symbol	Meaning	Symbol	Meaning
	Risk of danger. Important information. See Manual.		Hazardous voltage
	Conforms to European Union directives		Conforms to relevant South Korean EMC Standards
	Meets Underwriters' Laboratories safety requirements		Inspected and licensed by TÜV Product Services
	Conforms to relevant North American Safety Standards		Conforms to relevant Australian Standards
	Alternating current		Earth ground
	Direct current		Fuse
	Battery		Double insulated
CAT II	Measurement Category II is applicable to test and measuring circuits connected directly to utilization points (socket outlets and similar points) of the low-voltage MAINS installation.		
CAT III	Measurement Category III is applicable to test and measuring circuits connected to the distribution part of the building's low-voltage MAINS installation.		
CAT IV	Measurement Category IV is applicable to test and measuring circuits connected at the source of the building's low-voltage MAINS installation.		
	This product complies with the WEEE Directive (2002/96/EC) marking requirements. The affixed label indicates that you must not discard this electrical/electronic product in domestic household waste. Product Category: With reference to the equipment types in the WEEE Directive Annex I, this product is classed as category 9 "Monitoring and Control Instrumentation" product. Do not dispose of this product as unsorted municipal waste. Go to Fluke's website for recycling information.		

How to Get Started

If familiar with the Fluke 80 Series DMM, read “Using the Current Output Functions,” review the tables and figures in “Getting Acquainted with the Meter,” and begin using the meter.

If unfamiliar with Fluke 80 Series DMMs, or DMMs in general, read “Measuring Electrical Parameters” in addition to the sections referenced in the previous paragraph.

The sections following “Using the Current Output Functions” contain information about the power-up options, and battery and fuse replacement instructions.

Later, use the Quick Reference Guide to refresh your memory about the various functions and features that can be used.

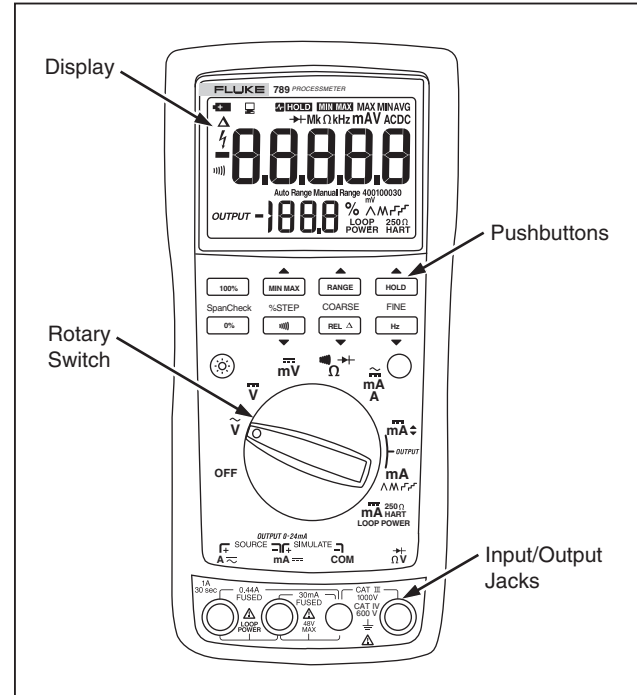

Figure 1. Fluke 789 ProcessMeter

anw014f.eps

Getting Acquainted with the Meter

To become familiar with the features and functions of the meter, study the following figures and tables.

- Figure 2 and Table 2 describe the input/output jacks.
- Figure 3 and Table 3 describe the input functions of the first six rotary function switch positions.
- Figure 4 and Tables 4 and 5 describe the output functions of the last three rotary function switch positions.
- Figure 5 and Table 6 describe the functions of the pushbuttons.
- Figure 6 and Table 7 explain what all the elements of the display indicate.

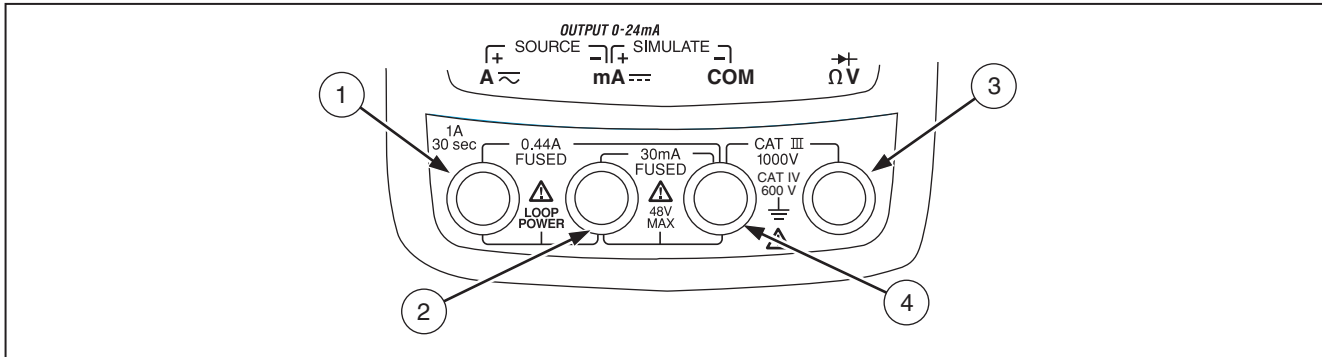





Figure 2. Input/Output Jacks

anw001f.eps

Table 2. Input/Output Jacks

Item	Jack	Measurement Functions	Source Current Function	Simulate Transmitter Function
①	A 	Input for current to 440 mA continuous. (1 A for up to 30 seconds.) Fused with a 440 mA fuse.	Output for dc current to 24 mA. Output for loop power supply.	
②	mA 	Input for current to 30 mA. Fused with a 440 mA fuse.	Common for dc current output to 24 mA. Common for loop power supply.	Output for transmitter simulation to 24 mA. (Use in series with an external loop supply.)
③	 V  Ω	Input for voltage to 1000 V, Ω , continuity, and diode test.		
④	COM	Common for all measurements.		Common for transmitter simulation to 24 mA. (Use in series with an external loop supply.)

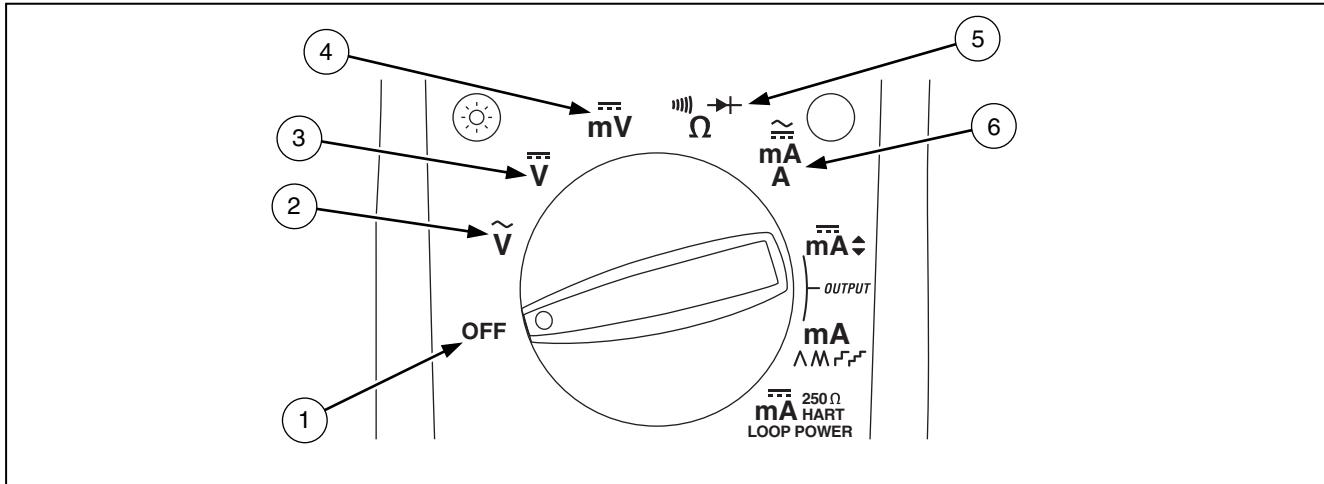
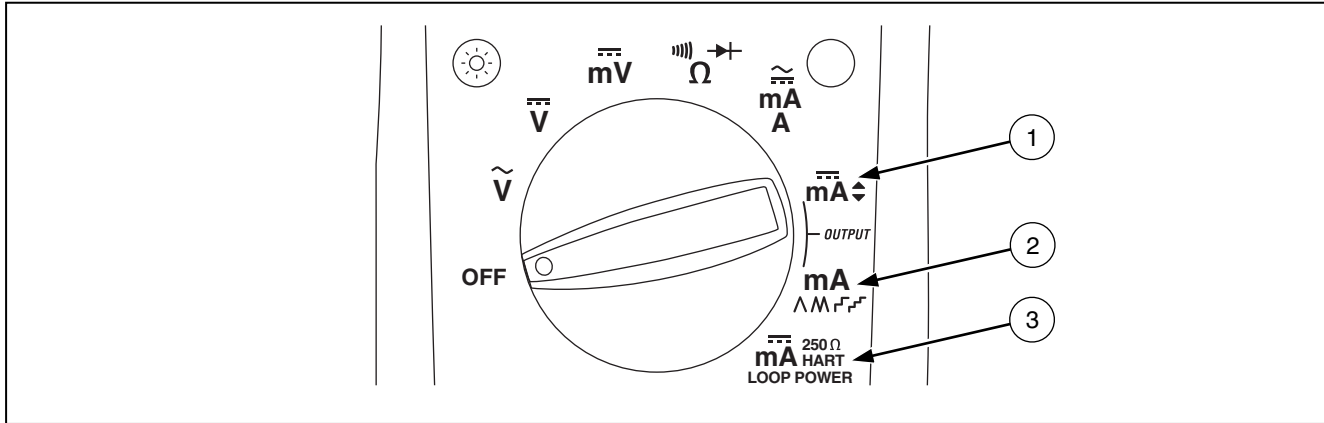

Figure 3. Rotary Function Switch Positions for Measurements

anw002f.eps

Table 3. Rotary Function Switch Positions for Measurements

No.	Position	Function(s)	Pushbutton Actions
①	OFF	Meter off	
②	\tilde{V}	Default: Measure ac V Hz Frequency counter	<div style="display: flex; flex-direction: column; gap: 5px;"> <div>MIN MAX Selects a MIN, MAX, or AVG action</div> <div>RANGE Selects a fixed range (hold 1 second for auto range)</div> <div>HOLD Toggles AutoHold</div> <div>REL Δ Toggles relative reading (sets a relative zero point)</div> </div>
③	\overline{V}	Default: Measure dc V Hz Frequency counter	Same as above
④	\overline{mV}	Default: Measure dc mV Hz Frequency counter	Same as above
⑤	Ω	Default: Measure Ω for continuity ○ (Blue) \rightarrow test	Same as above, except diode test has only one range
⑥	\overline{mA} A	<i>High test lead in \overline{A}:</i> Measure A dc ○ (Blue) selects ac <i>High test lead in \overline{mA}:</i> Measure mA dc	Same as above, except there is only one range for each input jack position, 30 mA or 1 A



anw008f.eps

Figure 4. Rotary Function Switch Positions for mA Output

Table 4. Rotary Function Switch Positions for mA Output



No.	Position	Default Function	Pushbutton Actions
①	OUTPUT 	<i>Test leads in</i> SOURCE: Source 0 % mA <i>Test leads in</i> SIMULATE: Sink 0 % mA	% STEP ▲ or ▼: Adjusts output up or down to the next 25 % step COARSE ▲ or ▼: Adjusts output up or down 0.1 mA FINE ▲ or ▼: Adjusts output up or down 0.001 mA <input type="button" value="0%"/> sets output to 0 % <input type="button" value="100%"/> sets output to 100 %
②	OUTPUT mA 	<i>Test leads in</i> SOURCE: Source repeating 0 % -100 %-0 % slow ramp (▲) <i>Test leads in</i> SIMULATE: Sink repeating 0 % -100 %-0 % slow ramp (▲)	○ (Blue) cycles through: <ul style="list-style-type: none"> • Fast repeating 0 % -100 % - 0 % ramp (M on display) • Slow repeating 0 % -100 % - 0 % ramp in 25 % steps (r on display) • Fast repeating 0 % -100 % - 0 % ramp in 25 % steps (r on display) • Slow repeating 0 % -100 % - 0 % ramp (▲ on display)

Table 5. Rotary Function Switch Position for Loop Supply

No.	Position	Default Function	Pushbutton Actions
③		Test leads in SOURCE: Supply > 24 V loop power, measure mA	○ (Blue) cycles through: <ul style="list-style-type: none"> • 250 Ω series resistor for HART communication switched in • 250 Ω series resistor switched out

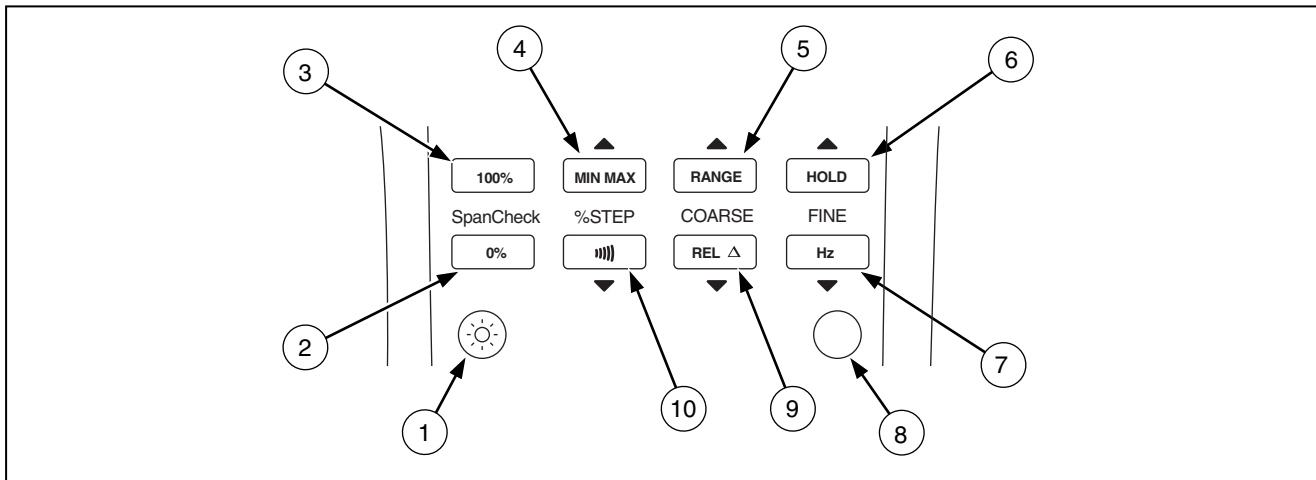

Figure 5. Pushbuttons

amw003f.eps

Table 6. Pushbuttons













No.	Pushbutton	Function(s)
①		Toggles the backlight (low, high, and off)
②	Span Check 	<i>mA Output:</i> Adjusts mA output to 0 % value (4 mA or 0 mA)
③	 Span Check	<i>mA Output:</i> Sets mA output to 100 % value (20 mA)
④	▲  % STEP	<i>Measuring:</i> Selects a MIN, MAX, or AVG action <i>mA Output:</i> Adjusts mA output up to the next higher 25 % step
⑤	▲  COARSE	<i>Measuring:</i> Selects a fixed range (hold for 1 second for auto range) <i>mA Output:</i> Adjusts output up 0.1 mA
⑥	▲  FINE	<i>Measuring:</i> Toggles AutoHold, or in MIN MAX recording, suspends recording <i>mA Output:</i> Adjusts output up 0.001 mA

Table 6. Pushbuttons (cont.)

No.	Pushbutton	Function(s)
7	FINE  	<i>Measuring:</i> Toggles between frequency counter and voltage measurement functions <i>mA Output:</i> Adjusts output down 0.001 mA
8	 (BLUE) (alternate function)	Rotary function switch in $\overset{\approx}{\text{mA}}$ position and test lead plugged into A $\overline{\sim}$ jack: Toggles between ac and dc ampere measure Rotary function switch in $\overset{\approx}{\Omega}$ position: Toggles diode test function ($\rightarrow +$) Rotary function switch in <i>OUTPUT mA</i> \wedge \mathcal{M} \ulcorner \ulcorner position: cycles through <ul style="list-style-type: none"> • Slow repeating 0 % -100 % - 0 % ramp (\wedge on display) • Fast repeating 0 % -100 % - 0 % ramp (\mathcal{M} on display) • Slow repeating 0 % -100 % - 0 % ramp in 25 % steps (\ulcorner on display) • Fast repeating 0 % - 100 % - 0 % ramp in 25 % steps (\ulcorner on display) Rotary function switch in loop supply position <ul style="list-style-type: none"> • Switch in/out 250 Ω series resistor
9	COARSE  	<i>Measuring:</i> Toggles relative reading (sets a relative zero point) <i>mA Output:</i> Adjusts output down 0.1 mA
10	% STEP  	<i>Measuring:</i> Toggles between Ω measure and continuity functions <i>mA Output:</i> Adjusts mA output down to the next lower 25 % step

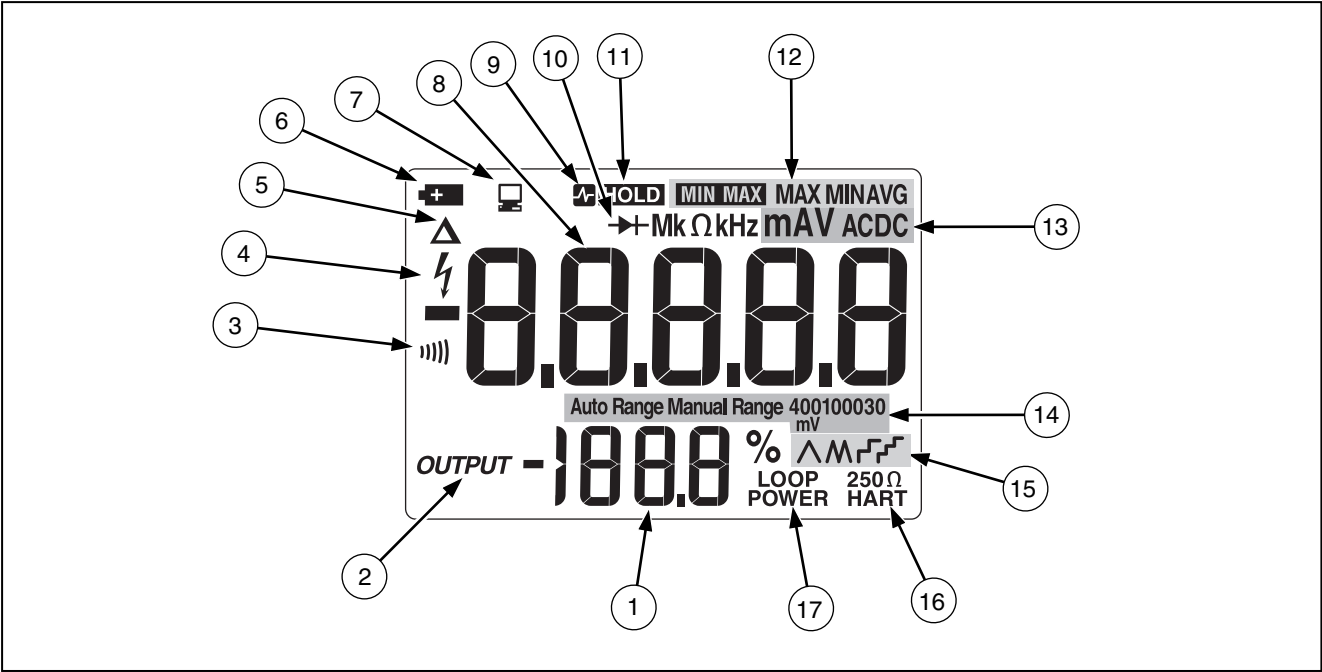

Figure 6. Elements of the Display

amw004f.eps

Table 7. Display





No.	Element	Meaning
①	% (Percentage display)	Shows the mA measured value or output level in %, in a 0-20 mA or 4-20 mA scale (change scales with power-up option)
②	OUTPUT	Lights when mA output (source or simulate) is active
③)))	Lights in continuity function
④		Lights when dangerous voltage is present
⑤	△	Lights when relative reading is on
⑥		Lights when the battery is low
⑦		Lights when the meter is transmitting or receiving over the IR port
⑧	Numerals	Show the input or output value
⑨ ⑪		Lights when AutoHold is on
⑩		Lights in diode test function
⑪	HOLD	Lights when MIN MAX recording is held
⑫	MIN MAX MAX MIN AVG	MIN MAX recording status indicators: MIN MAX - MIN MAX recording is on MAX - the display is showing the maximum-recorded value MIN - the display is showing the minimum-recorded value AVG - the display is showing the average value since starting recording (up to about 40 hours continuous recording time)

Table 7. Display (cont.)

No.	Element	Meaning
⑬	mA, DC, mV, AC, M or kΩ, kHz	Show the input or output units and multipliers associated with the numerals
⑭	Auto Range Manual Range	Range status indicators: Auto Range - autoranging is on Manual Range - the range is fixed
	40010030 mV	The number plus the unit and multiplier indicate the active range.
⑮	Λ M ⌚ ⌚	One of these lights in mA ramping or step output (rotary function switch position mAΛM⌚⌚): Λ - slow continuous 0 % - 100 % - 0 % ramping (40 seconds) M - fast continuous 0 % - 100 % - 0 % ramping (15 seconds) ⌚ - slow ramp in 25 % steps (15 seconds/step) ⌚ - fast ramp in 25 % steps (5 seconds/step)
⑯	250 Ω HART	Lights when 250 Ω series resistance is switched in
⑰	Loop Power	Lights when in loop supply mode

Measuring Electrical Parameters

The proper sequence for taking measurements follows:

1. Plug the test leads into the appropriate jacks
2. Set the rotary function switch to the desired function
3. Touch the probes to the test points
4. View the results on the LCD display

Input Impedance

For the voltage measurement functions, input impedance is 10 M Ω . See "Specifications" for more information.

Ranges

A measurement range determines the highest value and resolution at which the meter can measure. Most meter measurement functions have more than one range (see "Specifications").

Make sure the correct range is selected:

- If the range is too low, the display shows **OL** (overload).
- If the range is too high, the meter will not be displaying its most precise measurement.

The meter normally selects the lowest range that will measure the applied input signal (Auto Range showing on the display). Press **RANGE** to lock the range. Each time **RANGE** is pressed, the meter selects the next higher range. At the highest range, it returns to the lowest range.

If the range is locked, the meter resumes auto ranging when it is changed to another measurement function or when **RANGE** is pressed and held for 1 second.

Testing Diodes

To test a single diode:



1. Insert the red test lead into the $V\Omega\rightarrow|+$ jack and black test lead into the COM jack.
2. Set the rotary function switch to $\Omega \rightarrow|+$.
3. Press **○** (Blue) so that the $\rightarrow|+$ symbol is on the display.
4. Touch the red probe to the anode and the black probe to the cathode (side with band or bands). The meter should indicate the appropriate diode voltage drop.
5. Reverse the probes. The meter displays OL, indicating a high impedance.

6. The diode is good if it passes the tests in steps 4 and 5.



Displaying Minimum, Maximum, and Average

MIN MAX recording stores the lowest and highest measurements, and maintains the average of all measurements.

Press  to turn on MIN MAX recording. Readings are stored until the meter is turned off, switched to another measurement or source function, or MIN MAX is turned off. The beeper sounds when a new maximum or minimum is recorded. Auto power-off is disabled and auto ranging is turned off during MIN MAX recording.

Press  again to cycle through the MAX, MIN, and AVG displays. Press and hold  for 1 second to erase stored measurements and exit.

If MIN MAX recording is on continuously for over 40 hours, minimum and maximum readings are still recorded, but the displayed average no longer changes.

In MIN MAX recording, press  to suspend recording; press  again to resume recording.

Using AutoHold

Note

MIN MAX recording must be off to use AutoHold.

Warning

To avoid possible electric shock, do not use AutoHold to determine if dangerous voltage is present. AutoHold will not capture unstable or noisy readings.

Activate AutoHold to freeze the meter's display on each new stable reading (except in the frequency counter mode). Press  to activate AutoHold. This feature allows measurements to be taken in situations in which it is difficult to look at the display. The meter beeps and updates the display with each new stable reading.

Compensating for Test Lead Resistance

Use the relative reading feature (Δ on the display) to set the present measurement as a relative zero. A common use for this feature is to compensate for test lead resistance when measuring ohms.

Select the Ω measure function, touch the test leads together, and then press $\overline{\text{REL } \Delta}$. Until $\overline{\text{REL } \Delta}$ is pressed again, or the meter is switched to another measurement or source function, the readings on the display will subtract the lead resistance.

Using the Current Output Functions

The meter provides steady, stepped, and ramped current output for testing 0-20 mA and 4-20 mA current loops. Choose source mode, in which the meter supplies the current, simulate mode, in which the meter regulates

current in an externally powered current loop, or loop supply mode, where the meter powers an external device and measures the loop current.

Source Mode

Source mode is selected automatically by inserting the test leads into the SOURCE + and – jacks as shown in Figure 7. Use source mode whenever it is necessary to supply current into a passive circuit such as a current loop with no loop supply. Source mode depletes the battery faster than simulate mode, so use simulate mode whenever possible.

The display looks the same in source and simulate modes. The way to tell which mode is in use is to see which pair of output jacks is in use.

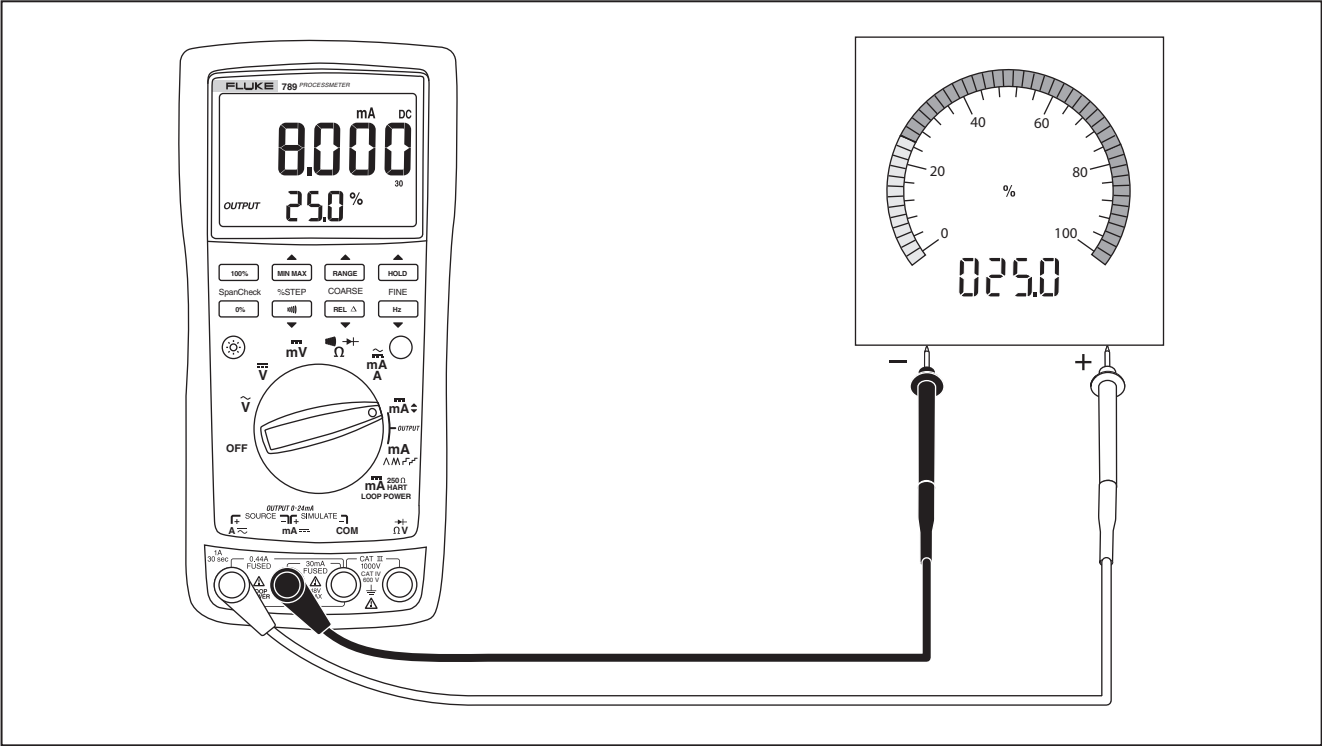

Figure 7. Sourcing Current

anw010f.eps

Simulate Mode

Simulate mode is so named because the meter simulates a current loop transmitter. Use simulate mode when an external dc voltage of 15 to 48 V is in series with the current loop under test.

Caution

Set the rotary function switch to one of the mA output settings BEFORE connecting the test leads to a current loop. Otherwise, a low impedance from the other rotary function switch positions could be presented to the loop, causing up to 35 mA to flow in the loop.

Simulate mode is selected automatically by inserting the test leads into the SIMULATE + and – jacks as shown in Figure 8. Simulate mode conserves battery life, so use it instead of source mode whenever possible.

The display looks the same in source and simulate modes. The way to tell which mode is in use is to see which pair of output jacks is in use.



Changing the Current Span

The meter's current output span has two settings (with overrange to 24 mA):

- 4 mA = 0 %, 20 mA = 100 % (factory default)
- 0 mA = 0 %, 20 mA = 100 %

To find out which span is selected, short the OUTPUT SOURCE + and – jacks, turn the rotary function switch to OUTPUT  mA, and observe the 0 % output level.

To toggle and save the current output span in nonvolatile memory (retained when the power is turned off):

1. Turn off the meter.
2. Hold down  while turning the meter on.
3. Wait at least 2 seconds, then release .

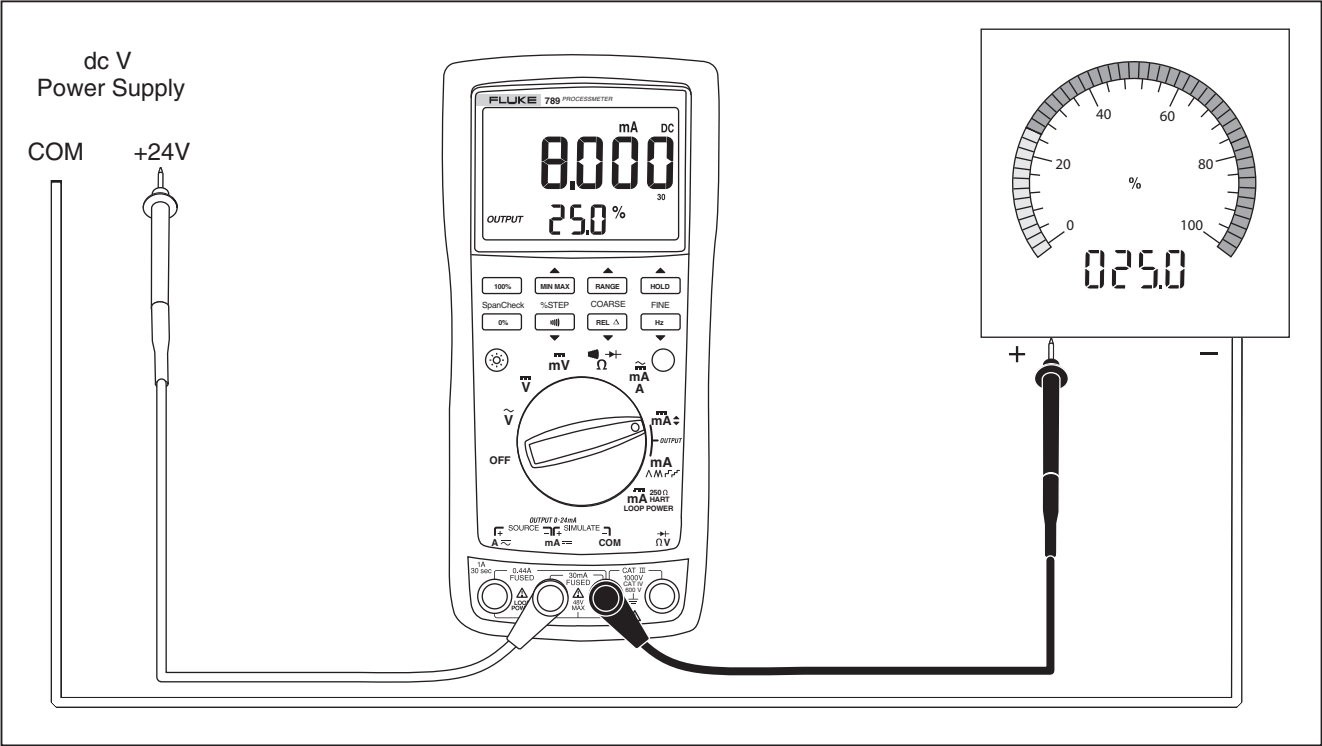

Figure 8. Simulating a Transmitter

anw011f.eps

Producing a Steady mA Output

When the rotary function switch is in the OUTPUT \blacklozenge mA position, and the OUTPUT jacks are connected to an appropriate load, the meter produces a steady mA dc output. The meter begins sourcing or simulating 0 %. Use the pushbuttons to adjust the current as shown in Table 8.

Select either sourcing or simulating by choosing the SOURCE or SIMULATE output jacks.

If the meter cannot deliver the programmed current because the load resistance is too high or the loop supply voltage is too low, dashes (-----) appear on the numeric display. When the impedance between the SOURCE jacks is low enough, the meter will resume sourcing.

Note

The STEP pushbuttons described Table 9 are available when the meter is producing a steady mA output. The STEP pushbuttons go to the next multiple of 25 %.

Table 8. mA Output Adjust Pushbuttons

Pushbutton	Adjustment
▲ RANGE COARSE	Adjusts up 0.1 mA
▲ MIN MAX FINE	Adjusts up 0.001 mA
FINE Hz	Adjusts down 0.001 mA
▼ COARSE REL Δ ▼	Adjusts down 0.1 mA

Manually Stepping the mA Output

When the rotary function switch is in the OUTPUT \blacklozenge mA position, and the OUTPUT jacks are connected to an appropriate load, the meter produces a steady mA dc output. The meter begins sourcing or simulating 0 %. Use the pushbuttons to step the current up and down in 25 % increments as shown in Table 9. See Table 10 for mA values at each 25 % step.

Select either sourcing or simulating by choosing the SOURCE or SIMULATE output jacks.

If the meter cannot deliver the programmed current because the load resistance is too high or the loop supply voltage is too low, dashes (----) appear on the numeric display. When the impedance between the SOURCE jacks is low enough, the meter will resume sourcing.

Note

The COARSE and FINE adjustment pushbuttons described in Table 8 are available when manually stepping the mA output.

Table 9. mA Stepping Pushbuttons







Pushbutton	Adjustment
	Adjusts up to the next higher 25 % step
	Adjusts down to the next lower 25 % step
	Sets to 100 % value
	Sets to 0 % value





Table 10. mA Step Values

Step	Value (for each span setting)	
	4 to 20 mA	0 to 20 mA
0 %	4.000 mA	0.000 mA
25 %	8.000 mA	5.000 mA
50 %	12.000 mA	10.000 mA
75 %	16.000 mA	15.000 mA
100 %	20.000 mA	20.000 mA
125 %	24.000 mA	
120 %		24.000 mA

Auto Ramping the mA Output

Auto ramping gives the ability to continuously apply a varying current stimulus from the meter to a transmitter, while hands remain free to test the response of the transmitter. Select either sourcing or simulating by choosing the SOURCE or SIMULATE jacks.

When the rotary function switch is in the OUTPUT **mA**   position, and the output jacks are connected to an appropriate load, the meter produces a continuously repeating 0 % - 100 % - 0 % ramp in a choice of four ramp waveforms:

-  0 % - 100 % - 0 % 40-second smooth ramp (default)
-  0 % - 100 % - 0 % 15-second smooth ramp
-  0 % - 100 % - 0 % Stair-step ramp in 25 % steps, pausing 15 seconds at each step. Steps listed in Table 10.
-  0 % - 100 % - 0 % Stair-step ramp in 25 % steps, pausing 5 seconds at each step. Steps are listed in Table 10.

The ramp times are not adjustable. Press  (Blue) to cycle through the four waveforms.

Note

At any time during auto ramping, the ramp can be frozen simply by moving the rotary function switch to the  mA position. Then the COARSE, FINE, and % STEP adjust pushbuttons can be used to make adjustments.





Power-Up Options

To select a power-up option, hold down the pushbutton shown in Table 11 while turning the rotary function switch from OFF to any on position. Wait 2 seconds before releasing the pushbutton after powering up the meter. The meter beeps to acknowledge the power-up option.

Only the setting for current span is retained when the power is turned off. The other options have to be repeated for each operating session.

Holding down more than one pushbutton can activate more than one power-up option.

Table 11. Power-Up Options

Option	Pushbutton	Default	Action Taken
Change current span 0 % setting		Remembers last setting	Toggles between 0 - 20 mA and 4 - 20 mA range
Disable beeper		Enabled	Disables beeper
Disable auto power-off	 (Blue)	Enabled	Disables the feature that turns off the meter power after 30 minutes of inactivity. Auto power off is disabled regardless of this option if MIN MAX recording is on.
Display test/show firmware version		Disabled	Display HOLD (as long as button is pushed), then shows firmware version.

Loop Power Supply Mode

The Loop Power Supply Mode can be used for powering up a process instrument (transmitter). While in Loop Power Mode, the meter acts like a battery. The process instrument regulates the current. At the same time, the meter measures the current that the process instrument is drawing.

The meter supplies loop power at a nominal 24 V dc. An internal series resistance of 250 Ω can be switched in for communication with HART and other smart devices by pressing \bigcirc (Blue). Pressing \bigcirc (Blue) again switches out this internal resistance.

When loop power is enabled, the meter is configured to measure mA and > 24 V dc is sourced between the mA and A jacks. The mA jack is the common and the A jack is at > 24 V dc. Connect the meter in series with the instrument current loop as Figure 10 shows.

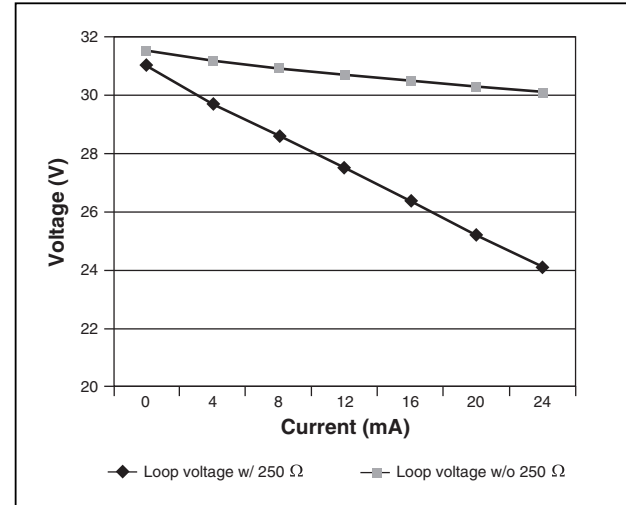

Figure 9. Loop Power Voltage vs. Current

anw020f.eps

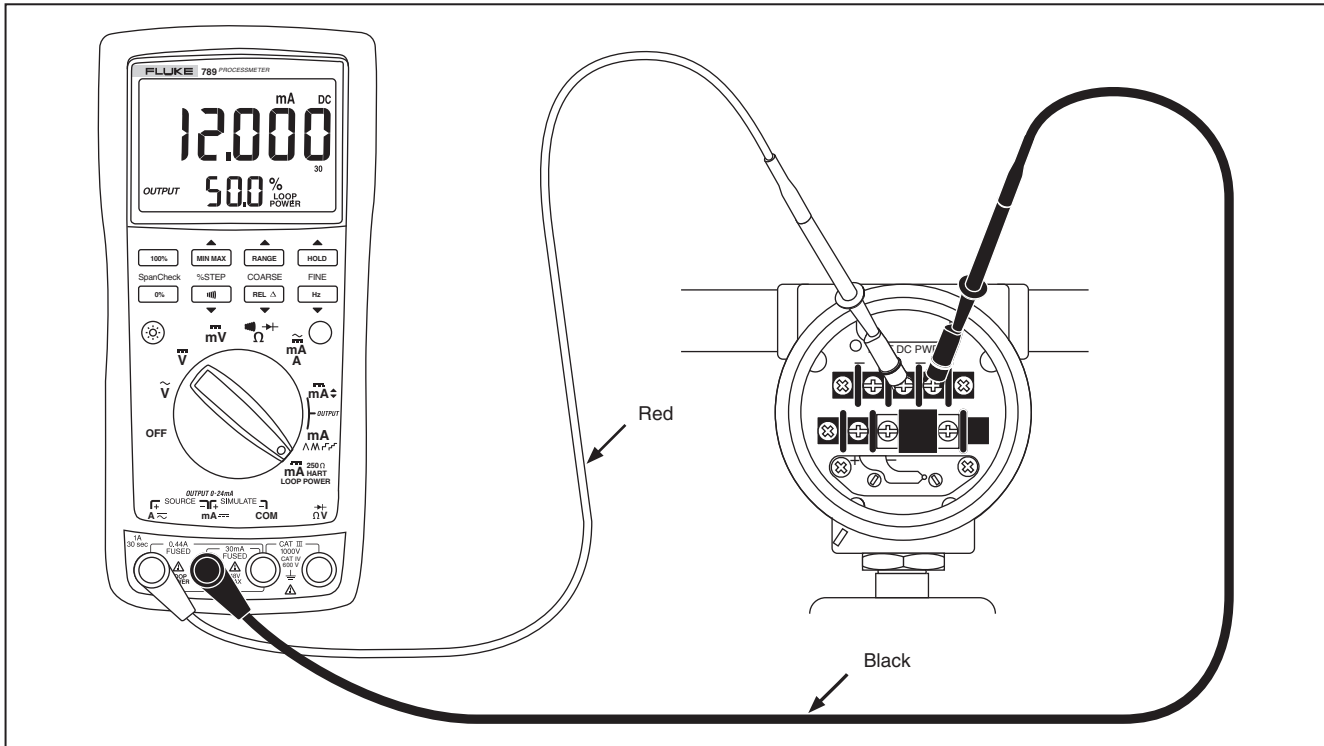

Figure 10. Connections for Supplying Loop Power

anw009f.eps

Battery Life

Warning

To avoid false readings, which could lead to possible electric shock or personal injury, replace the battery as soon as the battery indicator () appears.

Table 12 shows typical alkaline battery life. To preserve battery life:

- Use current simulation instead of sourcing when possible.
- Avoid using the backlight.
- Do not disable the automatic power-off feature.
- Turn the meter off when not in use.

Table 12. Typical Alkaline Battery Life

Meter Operation	Hours
Measuring any parameter	140
Simulating Current	140
Sourcing 12 mA into 500 Ω	10

Maintenance

This section provides some basic maintenance procedures. Repair, calibration, and servicing not covered in this manual must be performed by qualified personnel. For maintenance procedures not described in this manual, contact a Fluke Service Center.

General Maintenance

Periodically wipe the case with a damp cloth and detergent; do not use abrasives or solvents.

Calibration

Calibrate the meter once a year to ensure that it performs according to its specifications. Contact a Fluke Service Center for instructions.

Replacing the Batteries

Warning

To avoid electrical shock:

- **Remove test leads from the meter before opening the battery door.**
- **Close and latch the battery door before using the meter.**

Replace the batteries as follows. Refer to Figure 11. Use four AA alkaline batteries.

1. Remove the test leads and turn the meter OFF.

2. With a standard blade hand screwdriver, turn each battery door screw counterclockwise so that the slot is parallel with the screw picture molded into the case.
3. Lift off the battery door.
4. Remove the meter's batteries.
5. Replace with four new AA alkaline batteries.
6. Reinstall the battery door and tighten screws.

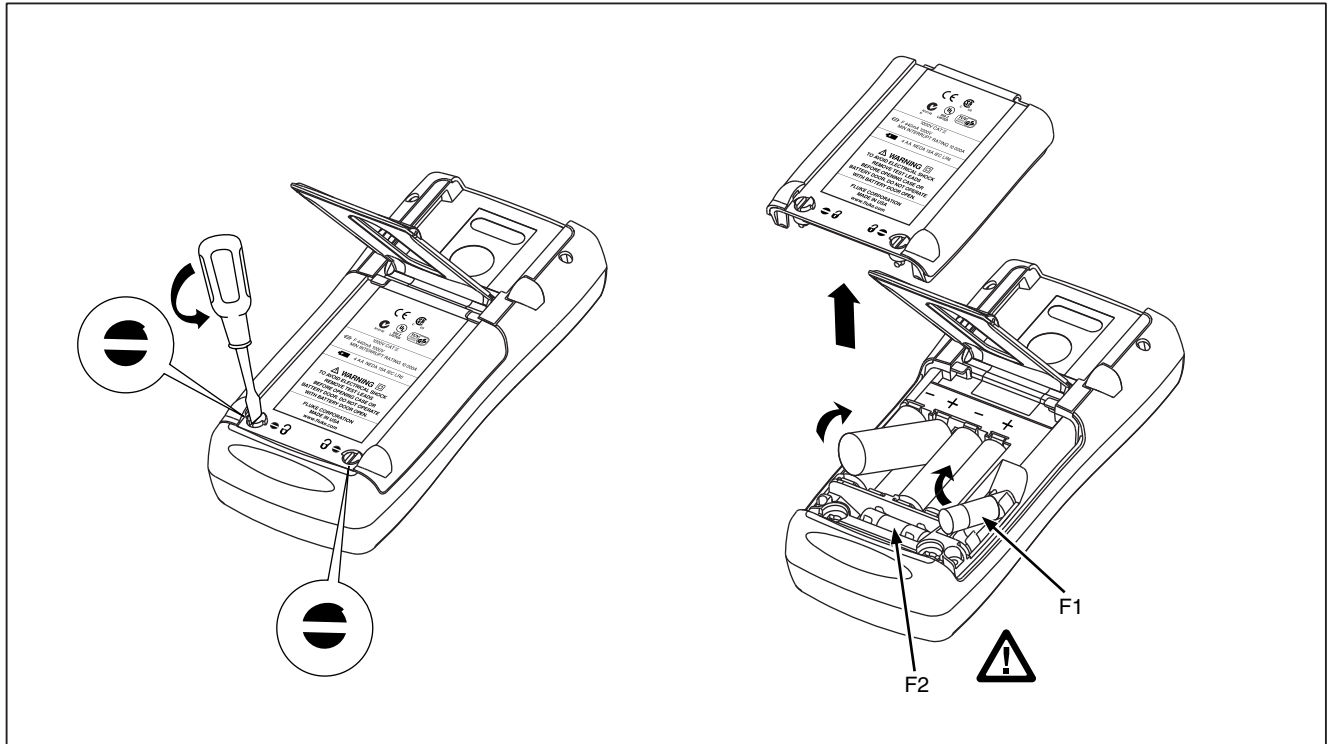

Figure 11. Replacing the Batteries and Fuses

anw037.eps

Replacing a Fuse

Warning

To avoid personal injury or damage to the meter, use only the specified replacement fuse, 440 mA 1000 V fast-blow, Fluke PN 943121.

Both current input jacks are fused with separate 440 mA fuses. To determine if a fuse is blown:

1. Turn the rotary function switch to $\frac{\approx}{mA}$.
2. Plug the black test lead into COM, and the red test lead into the $A \approx$ input.
3. Using an ohmmeter, check the resistance between the meter test leads. If the resistance is about 1Ω , the fuse is good. An open reading means that fuse F1 is blown.
4. Move red test lead to **mA**.
5. Using an ohmmeter, check the resistance between the meter test leads. If the resistance is about 14Ω , the fuse is good. An open means that fuse F2 is blown.

If a fuse is blown, replace it as follows. Refer to Figure 11 as necessary:

1. Remove the test leads from the meter and turn the meter OFF.
2. With a standard blade hand screwdriver, turn each battery door screw counterclockwise so that the slot is parallel with the screw picture molded into the case.
3. Remove either fuse by gently prying one end loose, then sliding the fuse out of its bracket.
4. Replace the blown fuse(s).
5. Replace the battery access door. Secure the door by turning the screws one-quarter turn clockwise.

If the Meter does not Work

- Examine the case for physical damage. If there is damage, make no further attempt to use the meter, and contact a Fluke Service Center.
- Check the battery, fuses, and test leads.
- Review this manual to make sure you are using the correct jacks and rotary function switch position.

If the meter still does not work, contact a Fluke Service Center. If the meter is under warranty, it will be repaired or replaced (at Fluke's option) and returned at no charge. See the Warranty on the back of the title page for terms. If the warranty has lapsed, the meter will be repaired and returned for a fixed fee. Contact a Fluke Service Center for information and price.

Replacement Parts and Accessories

⚠ Warning

To avoid personal injury or damage to the meter, use only the specified replacement fuse, 440 mA 1000 V fast-blow, Fluke PN 943121.

Note

When servicing the meter, use only the replacement parts specified here.

Replacement parts and some accessories are shown in Figure 12 and listed in Table 13. Many more DMM accessories are available from Fluke. For a catalog, contact the nearest Fluke distributor.

To find out how to order parts or accessories use the telephone numbers or addresses shown in "Contacting Fluke".

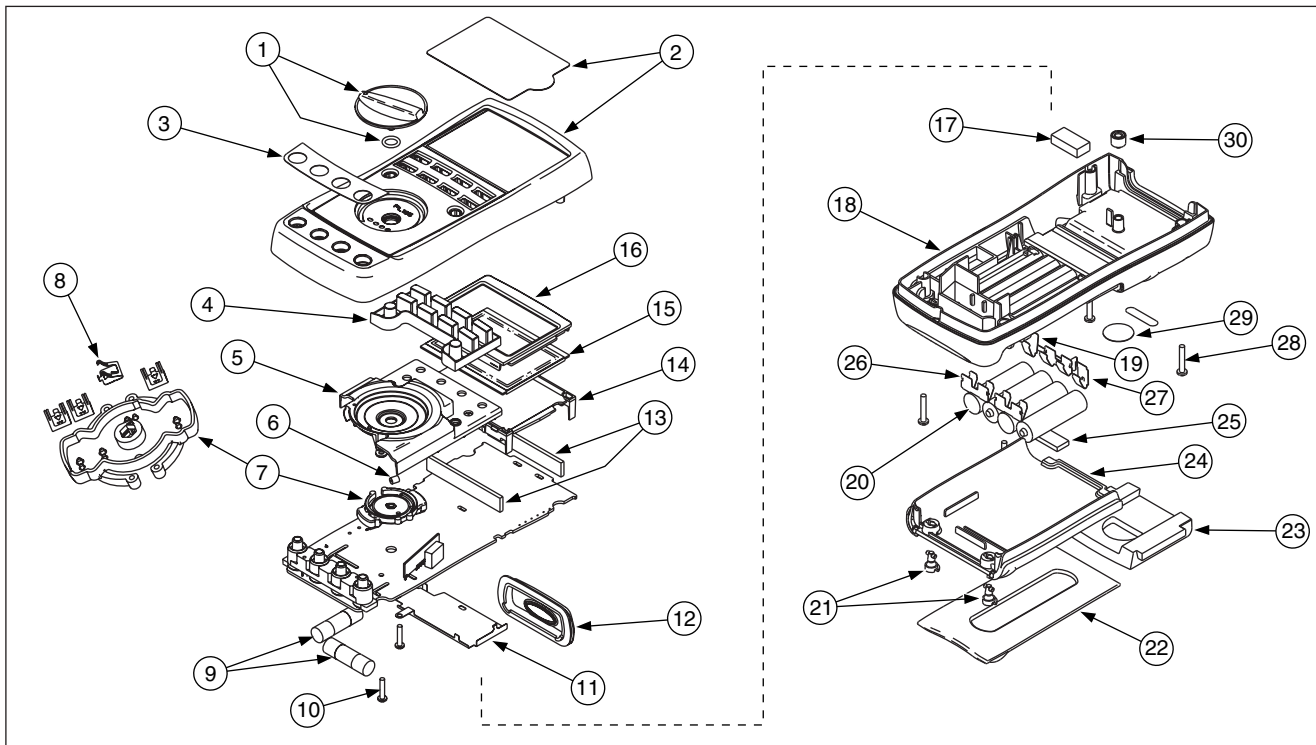

Figure 12. Replacement Parts

anw005f.eps

Table 13. Replacement Parts

Item Number	Reference Designator	Description	Fluke PN or Model no.	Quantity
①	MP14	Knob Assembly	658440	1
②	MP1	Top Case with Lens Protector	1622855	1
③	MP8	Decal, Top Case	1623923	1
④	MP6	Keypad	1622951	1
⑤	MP5	Top Shield	1622924	1
⑥	MP47	Top Shield Contact	674853	1
⑦	MP4	Contact Housing	1622913	1
⑧	MP28-31	RSOB Contact	1567683	4
⑨	 F1, F2	Fuse, 440 mA, 1000 V fast-blow	943121	2
⑩	H7,8	PCB Screw	832220	2
⑪	MP9	Bottom Shield	1675171	1
⑫	MP12	IR Lens	658697	1
⑬	MP40,41	LCD Connectors, Elastomeric	1641965	2
⑭	MP7	Backlight/Bracket	1622960	1
⑮	P1	LCD Display	1883431	1
⑯	MP3	Mask	1622881	1

Table 13. Replacement Parts (continued)

Item Number	Reference Designator	Description	Fluke PN or Model no.	Quantity
⑰	MP50	Shock Absorber	878983	1
⑱	MP11	Bottom Case	659042	1
⑲	MP20	Battery Contact, Negative	658382	1
⑳	BT1-4	Battery, 1.5 V, 0-15 mA, AA Alkaline	376756	4
㉑	H1-2	Fasteners, Battery/Fuse Access Door	948609	2
㉒	MP13	Tilt-Stand	659026	1
㉓	MP15	Accessory Mount with Probe Holders	658424	1
㉔	MP2	Access Door, Battery/Fuse	1622870	1
㉕	MP46	Shock Absorber	674850	1
㉖	MP16-18	Battery Contacts Dual	666435	3
㉗	MP19	Battery Contact, Positive	666438	1
㉘	H3-6	Case Screws	1558745	4
㉙	MP21	Calibration Label	948674	1
㉚	MP22	Calibration Keypad	658689	1
-	Not shown	Test Leads	variable ^[1]	1 (set of 2)
-	Not shown	Alligator Clips	variable ^[1]	1 (set of 2)
-	Not shown	789 Quick Reference	4276679	1
-	Not shown	CD-ROM (Contains Users Manual)	1636493	1

[1] See www.fluke.com for more information about the test leads and alligator clips available for your region.

Specifications

All specifications apply from +18 °C to +28 °C unless stated otherwise.

All specifications assume a 5-minute warm-up period.

The standard specification interval is 1 year.

Note

“Counts” refers to the number of increments or decrements of the least significant digit.

DC Volts Measurement

Range (V dc)	Resolution	Accuracy, \pm (% of Reading + Counts)
4.000	0.001 V	0.1 % + 1
40.00	0.01 V	0.1 % + 1
400.0	0.1 V	0.1 % + 1
1000	1 V	0.1 % + 1

Input impedance: 10 M Ω (nominal), < 100 pF
Normal mode rejection ratio: > 60 dB at 50 Hz or 60 Hz
Common mode rejection ratio: > 120 dB at dc, 50 Hz, or 60 Hz
Overvoltage protection: 1000 V

DC Millivolts Measurement

Range (mV dc)	Resolution	Accuracy, \pm (% of Reading + Counts)
400.0	0.1 mV	0.1 % + 2

AC Volts Measurement

Range (ac)	Resolution	Accuracy, \pm (% of Reading + Counts)		
		50 Hz to 60 Hz	45 Hz to 200 Hz	200 Hz to 500 Hz
400.0 mV	0.1 mV	0.7 % + 4	1.2 % + 4	7.0 % + 4
4.000 V	0.001 V	0.7 % + 2	1.2 % + 4	7.0 % + 4
40.00 V	0.01 V	0.7 % + 2	1.2 % + 4	7.0 % + 4
400.0 V	0.1 V	0.7 % + 2	1.2 % + 4	7.0 % + 4
1000 V	1 V	0.7 % + 2	1.2 % + 4	7.0 % + 4

Specifications are valid from 5 % to 100 % of amplitude range.

AC conversion: true rms

Maximum crest factor: 3 (between 50 and 60 Hz)

For non-sinusoidal waveforms, add \pm (2 % reading + 2 % f.s.) typical

Input impedance: 10 M Ω (nominal), < 100 pF, ac-coupled

Common mode rejection ratio: > 60 dB at dc, 50 Hz, or 60 Hz

In an RF field of 3 V/m, add 0.25 % of range

AC Current Measurement

Range 45 Hz to 2 kHz	Resolution	Accuracy, \pm (% of Reading + Counts)	Typical Burden Voltage
1.000 A (Note)	0.001 A	1 % + 2	1.5 V/A
<i>Note: 440 mA continuous, 1 A 30 seconds maximum</i>			
<i>Specifications are valid from 5 % to 100 % of amplitude range.</i>			
<i>AC conversion: true rms</i>			
<i>Maximum crest factor: 3 (between 50 and 60 Hz)</i>			
<i>For non-sinusoidal waveforms, add \pm(2 % reading + 2 % f.s.) typical</i>			
<i>Overload protection 440 mA, 1000 V fast-blow fuse</i>			

DC Current Measurement

Range	Resolution	Accuracy, \pm (% of Reading + Counts)	Typical Burden Voltage
30.000 mA	0.001 mA	0.05 % + 2	14 mV/mA
1.000 A (Note)	0.001 A	0.2 % + 2	1.5 V/A
<i>Note: 440 mA continuous, 1 A 30 seconds maximum</i>			
<i>Overload protection: 440 mA, 1000 V fast-blow fuse</i>			
<i>In an RF field of 3 V/m, in 30.000 mA range, add 0.14 % of range</i>			

Ohms Measurement

Range	Resolution	Measurement Current	Accuracy, \pm(% of Reading + Counts)
400.0 Ω	0.1 Ω	220 μ A	0.2 % + 2
4.000 k Ω	0.001 k Ω	60 μ A	0.2 % + 1
40.00 k Ω	0.01 k Ω	6.0 μ A	0.2 % + 1
400.0 k Ω	0.1 k Ω	600 nA	0.2 % + 1
4.000 M Ω	0.001 M Ω	220 nA	0.35 % + 3
40.00 M Ω	0.01 M Ω	22 nA	2.5 % + 3

Overload protection: 1000 V
Open circuit voltage: <3.9 V

Frequency Counter Accuracy

Range	Resolution	Accuracy, ±(% of Reading + Counts)
199.99 Hz	0.01 Hz	0.005 % + 1
1999.9 Hz	0.1 Hz	0.005 % + 1
19.999 kHz	0.001 kHz	0.005 % + 1

Display updates 3 times/second at > 10 Hz

Frequency Counter Sensitivity

Input Range	Minimum Sensitivity (rms Sinewave) 5 Hz to 5 kHz*	
	AC	DC (approximate trigger level 5 % of full scale)
400 mV	150 mV (50 Hz to 5 kHz)	150 mV
4 V	1 V	1 V
40 V	4 V	4 V
400 V	40 V	40 V
1000 V	400 V	400 V

**Usable 0.5 Hz to 20 kHz with reduced sensitivity.
10⁶ VHz max*

Diode Test and Continuity Test

Diode test indication	Displays voltage drop across device, 2.0 V full scale. Nominal test current 0.2 mA at 0.6 V. Accuracy $\pm(2\% + 1 \text{ count})$.
Continuity test indication	Continuous audible tone for test resistance $<100 \Omega$
Open circuit voltage	2.9 V
Short circuit current	220 μA typical
Overload protection	1000 V rms

Loop Power Supply Voltage..... 24 V, Short Circuit protected

DC Current Output

Source mode:

Span	0 mA or 4 mA to 20 mA, with overrange to 24 mA
Accuracy	0.05 % of span ^[1]
Compliance voltage	28 V with battery voltage $>\sim 4.5 \text{ V}$

[1] In an RF field of 3 V/m, add 0.32 % of span

Simulate Mode

Span	0 mA or 4 mA to 20 mA, with overrange to 24 mA
Accuracy	0.05 % of span ¹
Loop voltage	24 V nominal, 48 V maximum, 15 V minimum
Compliance voltage	21 V for 24 V supply
Burden voltage	$<3 \text{ V}$

General Specifications

Maximum voltage applied between any jack and earth ground	1000 V
Battery Type	1.5 V, 0-15 mA, AA, Alkaline
Storage temperature	-40 °C to 60 °C
Operating temperature	-20 °C to 55 °C
Operating altitude	2000 meters maximum
Frequency Overload Protection	10 ⁶ V Hz max
Temperature coefficient	0.05 x specified accuracy per °C for temperatures <18 °C or >28 °C 0.1 x specified accuracy per °C for temperatures <18 °C or >28 °C
Relative humidity	95 % up to 30 °C, 75 % up to 40 °C, 45 % up to 50 °C, and 35 % up to 55 °C
Vibration	Random 2g, 5 to 500 Hz
Shock	1 meter drop test
Power requirements	Four AA batteries (alkaline recommended)
Size	10.0 cm X 20.3 cm X 5.0 cm (3.94 in X 8.00 in X 1.97 in)
Weight	610 g (1.6 lb)
Safety	IEC 61010-1: 600 V CAT IV / 1000 V CAT III, Pollution Degree 2
Electromagnetic Environment	IEC 61326-1: Portable
Electromagnetic Compatibility	Accuracy for all ProcessMeter functions is not specified in RF field > 3V/m Applies to use in Korea only.....Class A Equipment (Industrial Broadcasting & Communication Equipment ^[1])

[1] This product meets requirements for industrial (Class A) electromagnetic wave equipment and the seller or user should take notice of it. This equipment is intended for use in business environments and not to be used in homes.

