

User's Guide for

VIDAR *Dental Film Digitizer*

Serial numbers
210,000 to 219,999



© Copyright by VIDAR® Systems Corporation. All rights reserved.

Terms denoted by the trademark symbol (™ or ®) used in this publication are trademarks or service marks registered in the United States or other countries.

NOTE

The digitizers do not include application specific software (Picture Archiving and Communications [PAC] system, Teleradiology, Oncology Systems, or Computer Aided Detection [CAD] software). The manufacturer of the application software will determine specific indications for use. These third-party software packages or complete systems are approved separately from a regulatory perspective.



365 Herndon Parkway
Herndon, VA 20170 U.S.A.

Phone: 1-703-471-7070
Fax: 1-703-471-7665
Internet: www.filmdigitizer.com

Sales: 1-800-471-SCAN or
1-800-471-7226
Email: sales@VIDAR.com

Technical Support:
1-800-471-SCAN or 1-703-471-7070
E-mail: medtech@VIDAR.com



Emergo Europe
Molenstraat15
2513 BH, The Hague
The Netherlands

Phone: +31 (0) 70.345.8570
Fax: +31 (0) 70.346.7299
E-mail: service@emergogroup.com

Caution: No operator-serviceable parts inside. Refer servicing to qualified personnel.
Achtung: Gehäuse nicht öffnen. Wartung und Reparatur nur durch Elektrofachkräfte.
Attention: Aucune pièce ne peut être remplacée par l'utilisateur. Toute opération de maintenance doit être effectuée par une personne qualifiée.
Atencion: Acceso interno solo autorizado a personal técnico cualificado.
Attenzione: Non aprire. Rivolgersi a personale qualificato.

Radio Frequency Emissions

This equipment has been tested and found to comply with the limits for a Class A digital device, pursuant to Part 15 of the FCC Rules. These limits are designed to provide reasonable protection against harmful interference when the equipment is operated in a commercial environment. This equipment generates, uses, and can radiate radio frequency energy and, if not installed and used in accordance with the instruction manual, may cause harmful interference to radio communications. Operation of this equipment in a residential area can cause harmful interference, in which case the user will be required to correct the interference at his or her own expense.

Product compliance testing was conducted using VIDAR shielded cables. Modifications to the digitizer or the VIDAR shielded cables or the use of cables other than those available from VIDAR could void the user's authority to operate the equipment.

Acceptable shipping conditions

- Temperature: -15° to $+60^{\circ}\text{C}$ (5° to $+140^{\circ}\text{F}$)
- Relative humidity: 20% to 85%, non-condensing
- Atmospheric pressure: 500 to 1060hPa (+18,000 to -1,200ft)

Operating conditions

- Temperature: 15°C to 30°C (60°F to 85°F)
- Relative humidity: 20% to 85%, non-condensing
- Atmospheric pressure: 696 to 1013hPa (10,000 to 0 ft)

Electrical supply

- Voltage: 100 to 240 VAC
- Current: 1.0 to 0.42 A
- Frequency: 50 to 60 Hz

Safety and Compliance Information



5RA9



MEDICAL –GENERAL MEDICAL EQUIPMENT AS TO ELECTRIC SHOCK, FIRE AND MECHANICAL HAZARDS ONLY IN ACCORDANCE WITH: CAN/CSA C22.2 No.601.1-M90, IEC 60601-1, UL 60601-1, ANSI/AAMI ES60601-1(2005, 3RD Ed.), CAN/CSA-C22.2 No.60601-1(2008). IEC 60601-1:2005(3RD Ed.).

Accessory equipment connected to the analog and digital interfaces must be certified according to the respective IEC standards (i.e. IEC 60950 for data processing equipment and IEC 60601-1 for medical equipment). Furthermore all configurations shall comply with the system standard IEC 60601-1-1 or IEC 60601-1 3rd edition.

Everybody who connects additional equipment to the signal input part or signal output part configures a medical system, and is therefore responsible that the system complies with the requirements of IEC 60606-1-1 or IEC 60601-1 3rd edition. If in doubt, consult the technical services department or your local representative.

This product is rated for continuous use.

This product is in the Ordinary Equipment Class. It provides no protection against the ingress of water.

This product is not suitable for use in the presence of flammable anesthetic mixtures with air or with oxygen or with nitrous oxide.

Class I Medical Device; No Applied Parts. This product provides Class I medical device protection against electrical shock.

WARNING: To avoid the risk of electric shock, this equipment must only be connected to a supply mains with protective earth,

Grounding reliability can only be achieved when the equipment is connected to an equivalent receptacle marked “HOSPITAL ONLY: or HOSPITAL GRADE”.

WARNING: Do not modify this equipment without authorization of the manufacture.

Do not position the product so that it is difficult to disconnect the product from mains power supply.

Mains power may be removed from the product by disconnecting the power cable at the bottom of the product. Mains power may also be disconnected by unplugging the power cord from the external power supply adapter or unplugging the power cord from the wall outlet.

Power cords used with this device in North America must be rated by Underwriters Laboratories for hospital use.

Power cords used with this device in Europe must meet the requirements of IEC 227 Designation 53 or IEC 245 Designation 53.

This product is not suitable for use in a patient environment. Do not use the product or the host computer in the vicinity of a patient. Do not touch the product or the host computer while touching the patient.

The use of portable or mobile communications equipment and/or the presence of strong electromagnetic and/or x-ray fields may interfere with proper operation of this product. This product should not be used adjacent to or stacked with other equipment. If adjacent or stacked use is necessary, verify normal operation in the configuration in which it will be used. Should such interference occur, the user is required to provide adequate isolation between the digitizer and the source of the interference. Isolation is typically achieved by moving the digitizer away from the source of the interference.

Correct and safe operation of the digitizer requires familiarity with information that is not marked on the product. The following symbols indicate that the operator should consult the manual for additional information:



Contents

Intended Use	6
Operating	7
Turning the Digitizer On and Off	7
About Films	8
Feeding Films and Carriers	9
Troubleshooting	11
Normal Operation	11
Power Adapter Information	11
In Case of Difficulty	12
Error Conditions	12
Operational Problems	13
Cleaning and Maintaining	15
Cleaning the Diffuser	15
Replacing the LED Bar	24
Appendix: Electromagnetic Guidance	25
Appendix: Symbols	29

Intended Use

The VIDAR dental film digitizer is used for making digital copies of x-ray film commonly used in dental practices. Images captured with this device are intended for use in primary, secondary and over-reading applications. The target users of the device are medical professional or trained staff.

Operating

The Dental Film Digitizer

Turning the Digitizer On and Off

CAUTION: Do not apply power by plugging the DC power connector into the digitizer while the power adapter is live. Do not remove power by unplugging the DC power connector from the digitizer while the power adapter is live. Either of these actions could permanently damage the digitizer, the power adapter or both.

If the film digitizer is already on and ready to scan (LED on the front of the digitizer is solid green), then skip this section.

1. Ensure the PC is turned **off**.

Note: Always apply power to the digitizer before turning on the computer. This enables the computer to recognize the digitizer.

2. Turn on the digitizer (the switch is located behind the upper right corner of the digitizer body).

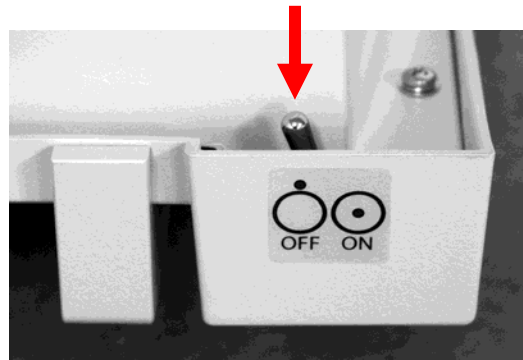

3. Observe the LED on the front of the digitizer: the LED should flash light blue for several minutes. This indicates the digitizer is performing internal tests and calibration.
4. When the LED stops flashing and remains solid green, turn on the PC.

The digitizer is now ready to scan films.

Note: For best possible imaging performance, please allow the unit to warm up for 30 minutes prior to use. You can also choose to leave the digitizer powered on and simply turn the PC on and off as needed.

CAUTION: X-ray images displayed on a computer monitor are representative only. Dimensional and grayscale inaccuracies may result from the build-up of tolerances in the digitizer, the display board and the computer. For this reason, special precautions must be exercised when taking measurements from the digitized image. Please refer to the user's manual for your digitizing software for more information if you wish to apply measurements.

About Films

The Dental Digitizer accepts films and carriers within the following dimensions:

- Minimum size: 6" (15.24 cm) wide x 4" (8.89 cm) long
- Maximum size: 13" (33.02 cm) wide x 13" (33.02 cm) long

Films in the following sizes can be scanned by placing them in a film holder that is within the above dimensions:

- Periapical Film – single tooth and surrounding structures:
 - Size 0 – 35 mm x 22 mm
 - Size 1 – 40 mm x 24 mm
 - Size 2 – 40.5 mm x 30.5 mm
- Bite Wing Film- interproximal examination:
 - Size 0 – 35 mm x 22 mm
 - Size 2 – 40.5 mm x 30.5 mm
 - Size 3 – 54 mm x 27 mm
- Occlusal Film – large areas of the mandible and maxilla
 - Size 4 – 57 mm x 76 mm

Note: VIDAR includes sample acceptable film holders with the film digitizer. These holders can be used multiple times, however they should not be used if they are torn or bent in any way. Additional holders can be purchased from VIDAR from your Rinn/Dentsply representative. The following part numbers are shipped with the VIDAR Dental Film Digitizer: 214567, 216081, 201163, 216200, 200138. Paper based or cardboard holders should NEVER be used in the VIDAR Dental Film Digitizer.

Films in the following sizes can be scanned by placing them directly in the digitizer:

- Extraoral: 5" x 7", 8" x 10", 10" x 12"
- Panoramic/Ceph: 5" x 12" (13 cm x 30 cm), 6" x 12" (15 cm to 30 cm)
- Other
 - 24 cm x 18 cm – to determine sagittal and vertical relationships
 - 24 cm x 22 cm – hand/wrist growth measurement exams

IMPORTANT: Remove stickers, tape, staples, paper clips, etc. from films before scanning. These may cause serious film feeding problems. Failure to remove extraneous items from films will void your warranty.

Feeding Films and Carriers

Note: The digitizer cannot scan films smaller than 6" width x 4" length (15.2cm x 10.2cm). Place smaller films in a carrier, then feed the carrier into the digitizer.

1. Ensure the LED on the front of the digitizer is solid green.
2. Place the film or carrier into the digitizer left justified as shown here:



When the Dental Film Digitizer detects the film/carrier, it *stages* the film/carrier—pulls it in about 1" (2.5cm), then pushes it back out about 1/2" (1.25cm). This may take a few seconds.

CAUTION: If the film or carrier is not staged properly, it is recommended to use the scanning application's "eject" command to remove the film. Gently pulling the film out of the digitizer will not harm the digitizer, but could potentially result in damage to the film.

Note: When a film/carrier has been staged, it is in the digitizer's light path. The ADC (Automatic Digitizer Calibration) feature requires that the light path be clear of the film/carrier for proper background calibration of the digitizer. The digitizer will automatically adjust the film or carrier's position to properly proceed with ADC. Depending on the location of the film or carrier's leading or trailing edge, and the length of time it has been blocking the light path, and then it will be: a) pushed up, b) pushed down, or c) ejected to remove it from the light path.

3. Using your scanning software, execute the **Scan** command.

The LED will flash green rapidly, indicating the scan is in progress.

When the scan is complete, the LED will return to solid green.

Note: After the scan, the film/carrier may or may not be ejected—your scanning software determines what happens. If the software's **Auto Eject** function is activated, the film/carrier will be pushed out. Otherwise, the lower rollers in the scanner will hold it until one of the following occurs:

- Another film/carrier is detected.
- You manually eject the film/carrier using the software.
- The ADC process begins by ejecting the film/carrier.

Note: Proper orientation of the film during loading depends on the scanning application program you are using. Some scanning programs rotate images 180° for display. If images appear upside down, you may be able to set the default orientation in the scanning application. If this option isn't available, then insert films into the digitizer reversed, as shown here.

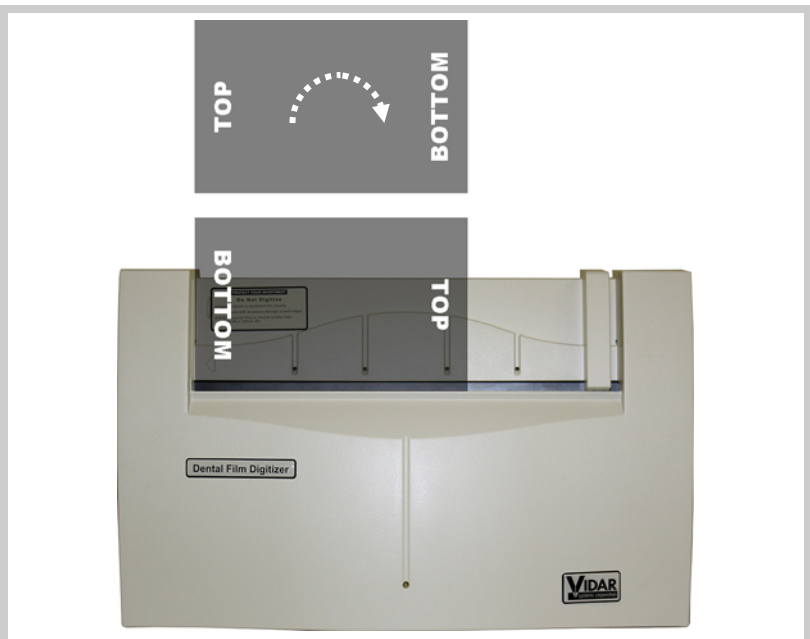

Troubleshooting

The Dental Film Digitizer

Normal Operation

LED indication	Condition
Flashing light blue	Digitizer calibrating, please wait.
Flashing dark blue	See “Error conditions” in the “In case of difficulty” section, later in this chapter.
Solid green	Ready to scan.
Flashing green	Scan in progress.

Power Adapter Information

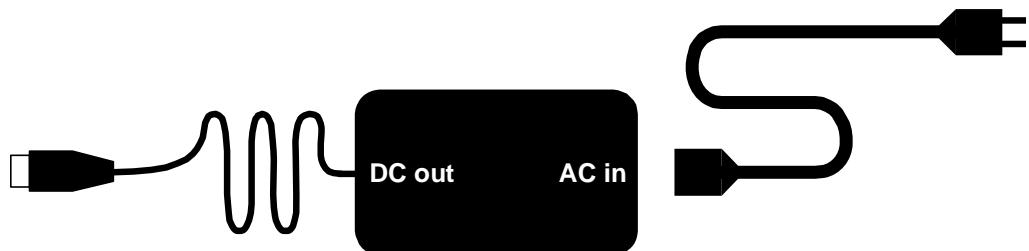

CAUTION: Power the digitizer **only** with the power supply adapter provided by your Service Provider or Vidar Systems Corp.

In Case of Difficulty

How to use this section:

1. Look through the left columns to find a description of the problem you are having.
2. Follow the instructions (in order) in the “Corrective action” column. If the one corrective action doesn’t solve the problem, then carry out the next corrective action.
3. When the instruction is “Get qualified technical help,” then:
 - a. Contact your system integration specialist (the company or person that installed your VIDAR film digitizer).
 - b. If your system integration specialist isn’t available, then contact VIDAR Customer Support (medtech@vidar.com or 1-703-471-7070). Please record system information before calling, and have it available when calling.

Tip: Check www.vidar.com for current troubleshooting information, tools and software updates.

Error Conditions

LED indication	Condition	Corrective action
Flashing dark blue.	Normalization error.	1. Clean lamp diffuser (see “Cleaning the diffuser” in the “Cleaning and maintaining” chapter, later in this manual). <i>or if that doesn’t solve the problem...</i> 2. Replace lamp (instructions are provided with the LED Bar Replacement Kit, VIDAR part number 18629). <i>or if that doesn’t solve the problem...</i> 3. Get qualified technical help.
No LED...	and digitizer functions correctly.	Get qualified technical help.
No LED...	and digitizer does not function.	1. Ensure that power cable is properly plugged into digitizer (power cable connects to bottom of digitizer). If digitizer then appears normal, wait for solid green LED, then reboot PC. <i>or if that doesn’t solve the problem...</i> 2. Ensure that electrical power cord is properly plugged into power adapter. If digitizer then appears normal, wait for solid green LED, then reboot PC. <i>or if that doesn’t solve the problem...</i> 3. Get qualified technical help.

continued

Operational Problems

Symptom	Corrective action
Film/carrier tilts or skews during scanning.	<ol style="list-style-type: none"> 1. Ensure individual films are loaded properly: bottom edge of film/carrier parallel to rollers, left edge of film/carrier up against digitizer body—as far left as it will go. (Review “Feeding films and carriers” in “Operating” chapter.) 2. Ensure that you are feeding the film straight. 3. Remove any foreign matter from film entrance slot. 4. If problem persists, get qualified technical help.
After film/carrier is loaded and staged properly, a few minutes later it is pushed out of staging area.	When film/carrier is staged, it is over digitizer’s light path. The digitizer’s ADC (Automatic Digitizer Calibration) feature requires that light path be clear for proper background calibration. Thus, if film/carrier remains in digitizer for more than 5 minutes, it will be pushed up 1/4" (0.6cm) to clear light path. Later, when you execute your software’s Scan command, film/carrier will be re-staged before it is digitized.
Digitizer has been off for several days. First film/carrier misfeeds or jams.	Run three or four films/carriers through digitizer: load them one at a time, then eject each one (or perform a scan on each film/carrier, but this takes longer).
Can’t turn digitizer on or off. Can’t find power switch.	The on/off switch is located behind the upper left corner of the digitizer body (when viewed from the front).
After applying power, LED on front keeps flashing light blue.	After power is applied, digitizer normally requires a little over 5 minutes to normalize and calibrate, during which time the LED will flash light blue. If LED flashes light blue for more than 15 minutes, turn digitizer power off and on again (as described later in this chapter), then reboot PC.
Streaks in image	Clean LED bar diffuser (see “Cleaning the diffuser” in the “Cleaning and maintaining” chapter, later in this manual).

continued

Symptom	Corrective action
LED is off, in spite of using proper power-on procedure described later in this chapter.	<ol style="list-style-type: none"> 1. Ensure wall outlet is providing AC power: obtain another electrical device known to be working, and plug it into that AC wall outlet. <ul style="list-style-type: none"> ■ If other device doesn't work, AC power is not available at that wall outlet. Get help from building services. ■ If other device does work, AC power is available from that outlet. Go to step 2. 2. With power applied to digitizer, look into digitizer film entrance slot. If you see light coming from inside digitizer, power is on. For this condition (LED off, internal light on), get qualified technical help. 3. If you have another Dental Film Digitizer, try its power adapter. <ul style="list-style-type: none"> ■ If digitizer works with other power adapter, original power adapter is defective. Obtain replacement VIDAR Dental Film Digitizer power adapter from your system integration specialist. Do not substitute any other power adapter. ■ If digitizer does not work with a known good power adapter, get qualified technical help.
CAUTION: Using a non-approved power adapter will void the warranty.	
Film/carrier starts and stops during scanning.	<ol style="list-style-type: none"> 1. Increase memory allocation for scanning software. (Especially if scanning at high resolutions, memory allocation must be sufficient to accept data stream from digitizer.) 2. If scanning to disk, ensure sufficient space is available on disk drive. 3. Ensure PC has enough memory available to support scanning application. Close applications not needed for image acquisition from digitizer. 4. If problem persists, get qualified technical help.
Digitizer stops scanning and PC locks up.	<ol style="list-style-type: none"> 1. Reset entire system. Remember that digitizer should be powered before PC. <ol style="list-style-type: none"> a. Turn digitizer off. b. Shut down PC and turn it off. c. Turn digitizer on. d. After digitizer LED turns solid green, turn on PC. 2. Launch scanning software on PC, then try digitizing again. If problem persists, get qualified technical help. 3. Check for correct device driver installation.
Digitizer was working properly, but after installing (or reinstalling) the scanning application there are Toolkit errors or the digitizer is not detected.	<ol style="list-style-type: none"> 1. If you installed a new scanning application, or if you reinstalled the existing application, the older Toolkit (vscsi32.dll) may have been installed. Run the VIDAR Drivers and Toolkit Installation CD (see appropriate section in the "Installation Guide for Dental Film Digitizer.>"). 2. If problem persists, contact medtech@vidar.com or call Medtech at 1-703-471-7070.
Digitizer is not listed in Windows Control Panel > Scanners and Cameras.	<ol style="list-style-type: none"> 1. Update to or reinstall STI drivers. See the "Install device drivers and toolkit" chapter of the "Installation Guide for Dental Film Digitizer." 2. Check all USB cables and connectors.

Cleaning and Maintaining

The Dental Film Digitizer

Cleaning the Diffuser

Note: Use this procedure only when you observe streaks in images, or when the digitizer's LED flashes dark blue.

Note: Use this procedure only for Dental Film Digitizers with serial numbers between 210,000 and 219,999.

IMPORTANT: You must follow these instructions when cleaning the diffuser. Deviation from these instructions will void the product's warranty and will likely result in costly repairs.

You will need:

- #2 (medium) Phillips screwdriver.
- #1 (small) Phillips screwdriver
- Small cutters
- Soft cloth or foam sheet to protect front of digitizer.
- Lint-free wipes (VIDAR part number 15194).
- 2 cable ties.

1. Shut down system.

- a. Shut down and turn off PC.
- b. Turn digitizer power switch off.

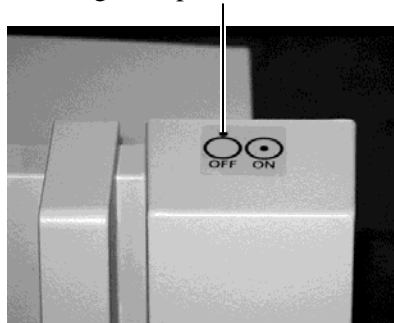

- c. Disconnect digitizer power adapter cord from wall outlet.
- d. Disconnect USB cable and power cable from bottom of digitizer.
- e. Remove digitizer from stand.

2. Prepare digitizer.

- a. Using 1.5mm Allen key, remove four screws from film feed area.



- b. Place digitizer face down on soft cloth or foam sheet. Top should be toward you.

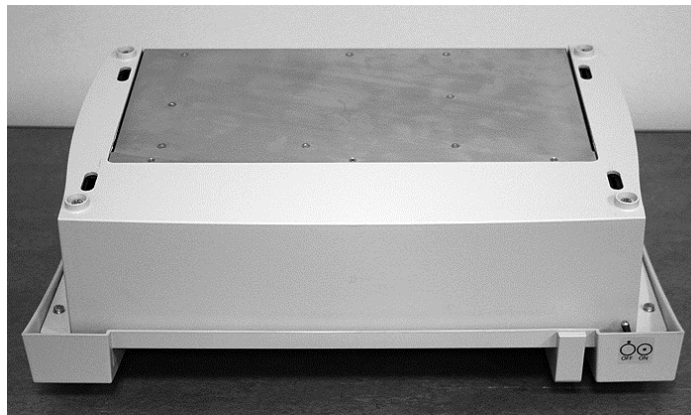

3. Open digitizer.

- a. Remove four screws securing front cover (two screws shown here by arrows; other two are on opposite end of front cover).

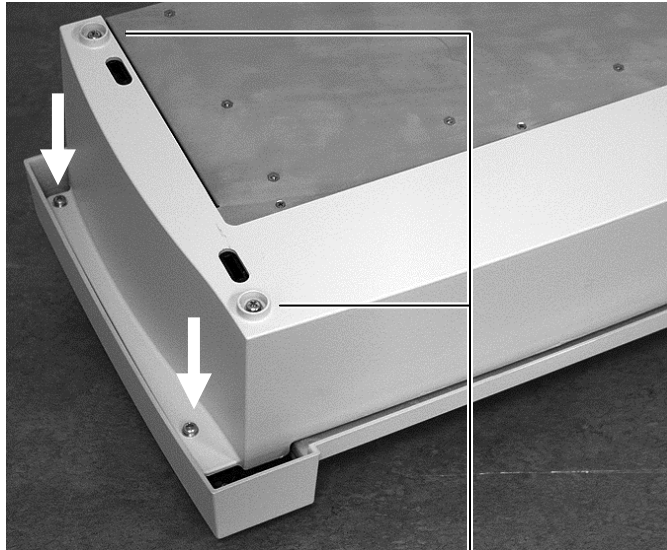

D
Do not remove four screws in feet on rear cover.

- b. Holding cover in place, flip entire unit over onto its feet (bottom toward you).
- c. Rotate front cover up.

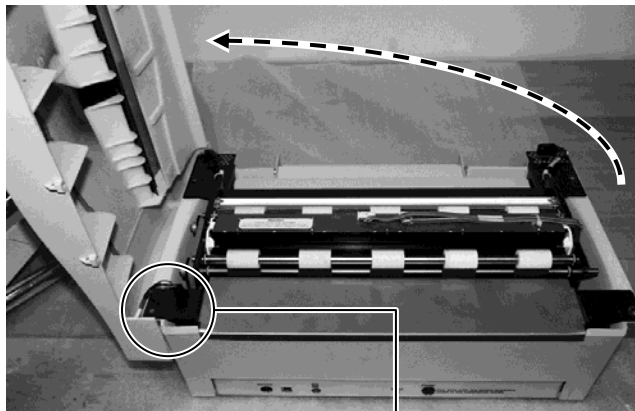

- d. Disconnect front display LED cable.
- e. Place cover aside.

4. Remove LED bar.

- a. Cut the cable tie securing the cables to the LED bar.

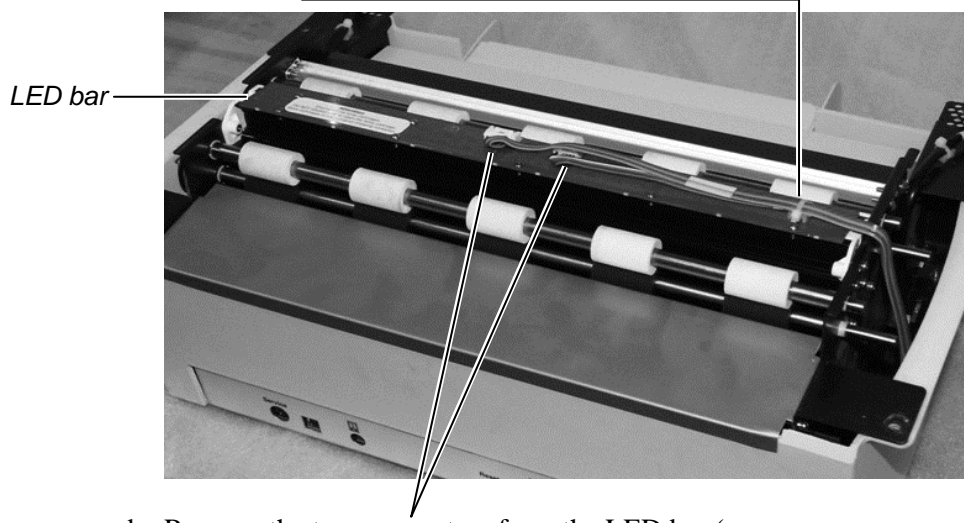

- b. Remove the two connectors from the LED bar (press in on each latch to release the connector from its socket).
- c. Remove four screws securing LED bar to main unit frame (two screws at each end).

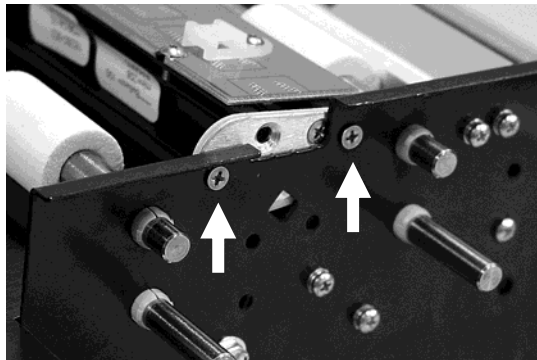

- d. Remove the upper screws at each end of the LED bar.

- e. Grasp both ends of LED bar, then pull gently upward until it is free of main unit frame.

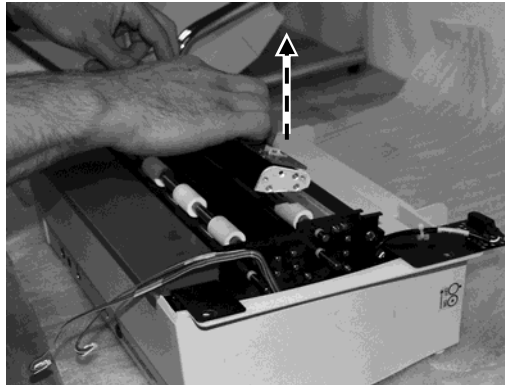

5. Clean diffuser.

Using lint-free wipe, clean entire length of diffuser (white plastic strip) on LED bar. Clean diffuser with a single pass for each unused area of the wipe. Do not scrub the diffuser.

CAUTION: Clean only with lint-free wipes provided by VIDAR (part number 15194). Other cloth or paper wipes will leave fibers on the diffuser, which can affect performance.

After cleaning, do not touch diffuser.

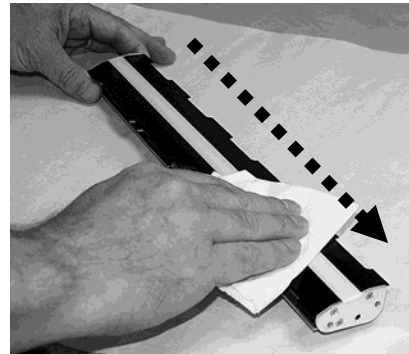

6. Reinstall LED bar.

- a. Hold LED bar in both hands with diffuser facing digitizer, and with cable tie mount to right.

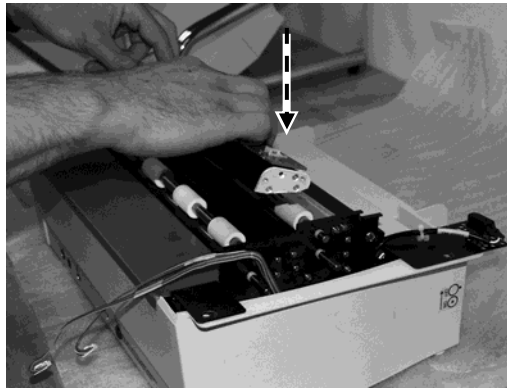

- b. Slide LED bar into main unit frame.
- c. Secure LED bar to main unit frame with four screws (two screws at each end). Tighten screws.

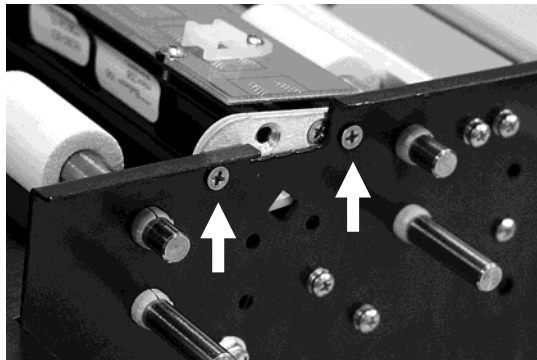

- d. Connect LED bar cables.

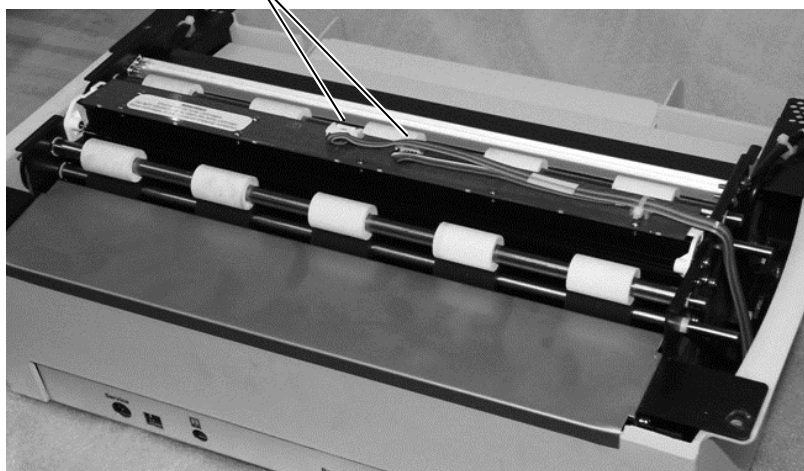

- e. Secure LED bar cables with cable tie. Cut off excess cable tie.

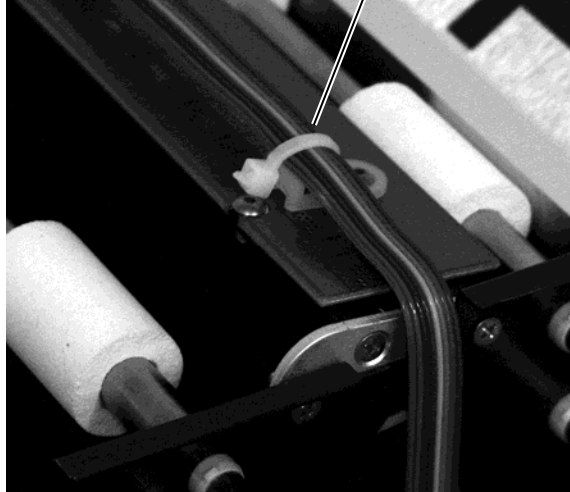

Cable tie must be in orientation shown (tail pointing toward digitizer bottom) or front cover will not seat properly.

7. Close digitizer.

- a. Place front cover next to main unit.
- b. Connect front LED display cable.

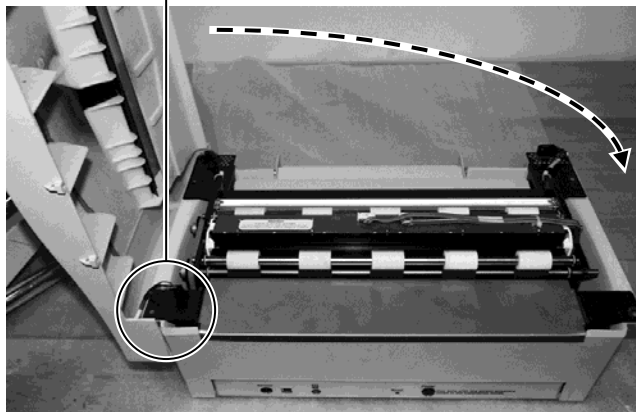

- c. Rotate front cover down onto main unit.

- d. Using four screws removed in step 3a, secure front cover to main unit (two screws shown here by arrows; other two are on opposite end of front cover).

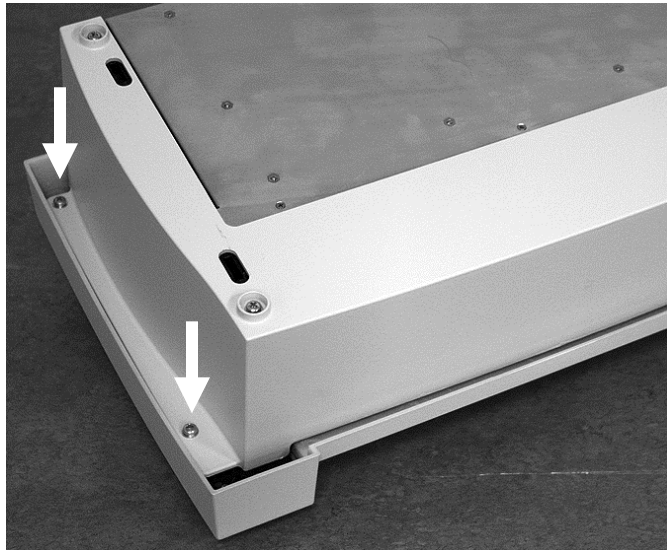

- e. Turn digitizer over.

8. Complete assembly.

- a. Using 1.5mm Allen key, insert four screws into film feed area.

Tighten screws so that the plastic edge is nearly flush with the blue edge. Pushing the plastic flush will help.



- b. Replace digitizer on its stand.

- c. Plug USB cable into USB port on bottom of digitizer.

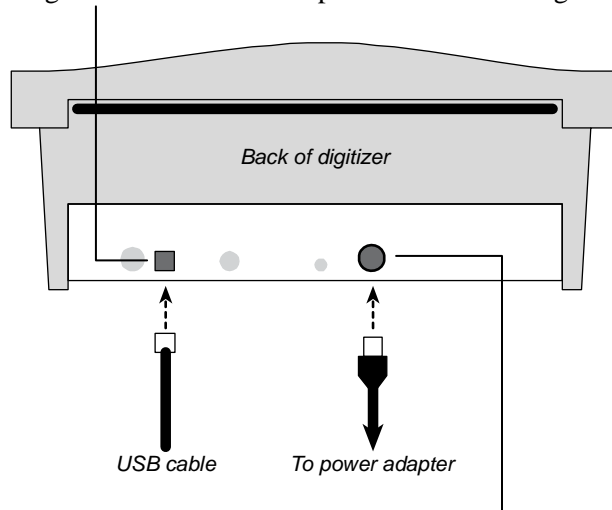

- d. Plug power cable into jack on bottom of digitizer.

9. Return digitizer to service.

- a. Assure PC is off.
- b. Plug digitizer power adapter cord into wall outlet.
- c. Turn digitizer power switch on.

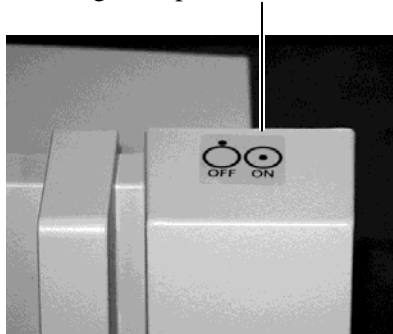

- d. Observe LED on front of digitizer: it should flash light blue for several minutes (indicating digitizer is performing internal tests and calibration).
- e. When LED stops flashing and remains solid green, turn on PC.
- f. Digitizer is now ready to scan films.

Replacing the LED Bar

Note: LED bars can only be replaced on Dental Digitizers with serial numbers between 210,000 and 219,999.

Please contact VIDAR Technical Support to order the Lamp Bar Replacement Kit, VIDAR part number 18629-001:

- Phone: 1-800-471-SCAN (1-800-471-7226)
1-703-471-7070 outside the U.S.
- E-mail: medtech@vidar.com

Instructions for replacing the LED bar are provided with the replacement kit.

Appendix:

Electromagnetic Guidance

<p>Caution: Medical electrical equipment. EMC (Electro Magnetic Compatibility) must be considered before any medical electrical equipment is installed or put into service. Follow the information in the accompanying documentation when installing and operating the VIDAR Dental Digitizer.</p>
<p>Caution: Portable or mobile RF communication equipment can effect Medical Electrical equipment.</p>
<p>Caution: Using the Digitizer adjacent to or stacked with other equipment may cause interference between the equipment. Before utilizing stacked or adjacent equipment, verify proper functionality of all equipment in the actual configuration in which it will operate.</p>
<p>Caution: Connecting the Digitizer to equipment that is not rated CISPR 11 class A or class B may alter the electromagnetic characteristics.</p>
<p>Caution: In a domestic environment this product may cause radio interference in which case the user may be required to take adequate measures.</p>

Guidance And Manufacturer's Declaration – Electromagnetic Equipment

Table 201

The Dental Film Digitizer is intended for use in the electromagnetic environment specified below. The customer or end user of the Dental Film Digitizer should assure that it is used in such an environment.

Emissions test	Compliance	Electromagnetic environment - guidance
RF Emissions CISPR11	Group 1	The Dental Film Digitizer uses RF energy only for its internal function. Therefore, its RF emissions are very low and are not likely to cause any interference in nearby electronic equipment.
RF Emissions, CISPR11	Class A	The Dental Film Digitizer is suitable for use in all establishments other than domestic and those directly connected to the public low voltage power supply network that supplies buildings used for domestic purposes.
Harmonic Emissions IEC 61000-3-2	Class A	
Voltage Fluctuations/ flicker emissions IEC 61000-3-3	Complies	

Guidance and Manufacturer's Declaration – Electromagnetic Immunity

Table 202

The Dental Film Digitizer is intended for use in the electromagnetic environment specified below. The customer or end user of the Dental Film Digitizer should assure that it is used in such an environment.

Immunity test	IEC 60601 test level	Compliance level	Electromagnetic environment - guidance
ElectroStatic Discharge (ESD) IEC 61000-4-2	+ 6 kV contact + 8 kV air	+ 6 kV contact + 8 kV air	Floors should be wood, concrete or ceramic tile. If floors are covered with synthetic material, the relative humidity should be at least 30%
Electrical fast transient/burst IEC 61000-4-4	±2 kV for power supply lines ±1 kV for input/output lines	±2 kV for power supply lines ±1 kV for input/output lines	Mains power quality should be that of a typical commercial or hospital environment.
Surge IEC 61000-4-5	±1 kV differential mode ±2 kV common mode	±1 kV differential mode ±2 kV common mode	Mains power quality should be that of a typical commercial or hospital environment.
Voltage dips, short interruptions and voltage variations on power supply input lines IEC 61000-4-11	<5 % U_T (>95 % dip in U_T) for 0,5 cycle 40 % U_T (60 % dip in U_T) for 5 cycles 70 % U_T (30 % dip in U_T) for 25 cycles <5 % U_T (>95 % dip in U_T) for 5 sec	<5 % U_T (>95 % dip in U_T) for 0,5 cycle 40 % U_T (60 % dip in U_T) for 5 cycles 70 % U_T (30 % dip in U_T) for 25 cycles <5 % U_T (>95 % dip in U_T) for 5 sec	Mains power quality should be that of a typical commercial or hospital environment. If the user of the Dental Film Digitizer requires continued operation during power mains interruptions, it is recommended that the Dental Film Digitizer be powered from an uninterruptible power supply or a battery
Power frequency (50/60 Hz) magnetic field IEC 61000-4-8	3 A/m	3 A/m	Power frequency magnetic fields should be at levels characteristic of a typical location in a typical commercial or hospital environment.

NOTE: U_T is the A.C. mains voltage prior to application of the test level

Guidance And Manufacturer's Declaration – Electromagnetic Immunity

Table 204

The Dental Film Digitizer is intended for use in the electromagnetic environment specified below. The customer or end user of the Dental Film Digitizer should assure that it is used in such an environment.

Immunity test	IEC 60601 test level	Compliance level	Electromagnetic environment - guidance
Conducted RF IEC 61000-4-6	3 Vrms 150 kHz to 80 MHz	3 V	Portable and mobile RF communication equipment should be used no closer to any part of the Dental Film Digitizer, including cables, than the recommended separation distance calculated from the equation applicable to the frequency of the transmitter. Recommended separation distance $d = 1.2\sqrt{P}$ $d = 1.2\sqrt{P} \quad 80 \text{ MHz to } 800 \text{ MHz}$ $d = 2.3\sqrt{P} \quad 800 \text{ MHz to } 2.5 \text{ GHz}$ Where P is the maximum output power rating of the transmitter in watts (W) according to the transmitter manufacturer and d is the recommended separation distance in meters (m). Field strengths from fixed RF transmitters, as determined by an electromagnetic site survey, ^a should be less than the compliance level in each frequency range. ^b Interference may occur in the vicinity of equipment marked with the following symbol: <div style="text-align: center;">  </div>
Radiated RF IEC 61000-4-3	3 V/m 80 MHz to 2,5 GHz	3 V/m	

Note 1: At 80MHz and 800MHz, the higher frequency range applies.

Note 2: These guidelines may not be applicable in all situations. Electromagnetic propagation is affected by absorption and reflection from structures, objects and people.

^a Field strengths from fixed transmitters, such as base stations for radio (cellular/cordless) telephones and land mobile radios, amateur radio, AM and FM radio broadcast and TV broadcast cannot be predicted theoretically with accuracy. To assess the electromagnetic environment due to fixed RF transmitters, an electromagnetic site survey should be considered. If the measured field strength in the location in which the Dental Film Digitizer is used exceeds the applicable RF compliance level above, the Dental Film Digitizer should be observed to verify normal operation. If abnormal performance is observed, additional measures may be necessary, such as reorienting or relocating the Digitizer.

^b Over the frequency range 150 kHz to 80 MHz, field strengths should be less than 3 V/m.

Recommended Separation Distances Between Portable And Mobile Rf Communications Equipment And The Dental Film Digitizer

Table 206

The Dental Film Digitizer is intended for use in an electromagnetic environment in which radiated RF disturbances are controlled. The customer or the user of the Dental Film Digitizer can help prevent electromagnetic interference by maintaining a minimum distance between portable and mobile RF communications equipment (transmitters) and the Dental Film Digitizer as recommended below, according to the maximum output power of the communications equipment.

Rated maximum output power of transmitter W	Separation distance according to frequency of transmitter, m		
	150 kHz to 80 MHz $d = 1.2\sqrt{P}$	80 MHz to 800 MHz $d = 1.2\sqrt{P}$	800 MHz to 2.5 GHz $d = 2.3\sqrt{P}$
0.01	0.12	0.12	0.23
0.1	0.37	0.37	0.74
1	1.2	1.2	2.3
10	3.7	3.7	7.4
100	12	12	23









For transmitters rated at a maximum output power not listed above, the recommended separation distance d in meters (m) can be estimated using the equation applicable to the frequency of the transmitter, where P is the maximum output power rating of the transmitter in watts (W) according to the transmitter manufacturer.

NOTE 1: At 80 MHz and 800 MHz, the separation distance for the higher frequency range applies.

NOTE 2: These guidelines may not apply in all situations. Electromagnetic propagation is affected by absorption and reflection from structures, objects and people.

Appendix:

Symbols

Symbol	Description
	Indicates the "OFF" condition for a part of equipment; not used to identify the "OFF" position of a switch.
	Indicates the "ON" condition for a part of equipment; not used to identify the "ON" position of a switch.
	Indicates the need for the user to consult the instructions for use for important cautionary information such as warnings and precautions that cannot, for a variety of reasons, be presented on the medical device itself.
	Indicates the need for the user to consult the instructions for use.
	Underwriters Laboratories classification symbol
	Compliance to EU Directives
	Authorized Representative in the European Community
	Indicates the Medical Device Manufacturer
	This symbol on the product indicates that this product must not be disposed of as unsorted municipal waste. Instead it is your responsibility to dispose of your waste equipment by handing it over to a designated collection point for recycling of waste electrical and electronic equipment. For more information about where you can dispose of your waste equipment for recycling please contact your local city office, your household waste disposal service or the shop where you purchased the product.



**365 Herndon Parkway
Herndon, VA 20170 USA**

**Phone: 1-703-471-7070
Main fax: 1-703-471-1165
Web: www.vidar.com**

**Technical Support:
Phone: 1-703-471-7070
1-800-471-7226
Fax: 1-703-471-7665
E-mail: medtech@vidar.com**