



IC1020
THERAPEUTIC MASSAGE CHAIR
FAUTEUIL DE MASSAGE THÉRAPEUTIQUE

USER MANUAL
MANUEL DE
L'UTILISATEUR



Built-in MP3 and headphones
MP3 intégré et casque d'écoute

MASSAGE CHAIR
FAUTEUIL DE MASSAGE



**PLEASE DO NOT RETURN
THIS PRODUCT TO THE STORE**
*FOR QUESTIONS OR ASSISTANCE ON ASSEMBLY, PARTS OR OPERATION,
CONTACT OUR CUSTOMER SERVICE!*

**S'IL VOUS PLAÎT, NE RENVOYEZ PAS
CE PRODUIT EN MAGASIN**
*POUR TOUTE QUESTION OU AIDE CONCERNANT LE MONTAGE,
LES PIÈCES OU LE FONCTIONNEMENT,
CONTACTEZ NOTRE SERVICE À LA CLIENTÈLE!*

**TOLL FREE CUSTOMER SERVICE /
SERVICE À LA CLIENTÈLE SANS FRAIS**
1 866 967.7333 ext. 227



Thank you for purchasing this product. Please read this instruction manual carefully before operating this massage chair.

Please pay attention to the important safety warnings and keep this manual for future use.

Note: EBI reserves the right to revise the design and description of this product without notice.

CONTENTS

1. Safety warning	2
2. Environment	2
3. Restrictions	3
4. Maintenance	3
5. Troubleshooting	3
6. Features and benefits	3
7. Installation	4
8. Components	7
9. Operation	9
10. Floor protection	16
11. Moving the chair	17
12. Product specifications	17
13. Warranty	18
FRANÇAIS	21



1. SAFETY WARNING

- This product is not recommended for children.
- Disconnect the chair before cleaning.
- Please pull out the plug after use or before cleaning to avoid injury or damage to the product.
- Please operate this product according to the instructions in this manual.
- Use only accessories recommended by **iComfort®**.
- This product is designed for indoor use only.
- Recommended use time is 30 minutes or less.
- Please avoid use if the chair is damaged and call your **iComfort®** technician or dealer.
- Make sure the chair ventilation holes in the lower back behind the chair are well ventilated and not obstructed.
- Please make sure small objects are not dropped into the chair mechanism.
- Use of this chair under the influence of drugs or alcohol is not recommended.
- Do not use wet hands to pull the AC cord.
- Do not spill liquids onto this product to avoid electric shock or cause damage to this product.
- Maintain your chair and avoid damaging the wires.
- Do not use a wet cloth to clean the electric parts.
- In the event of a power failure disconnect the chair.
- If the chair works abnormally, stop using it, disconnect the chair and call your **iComfort®** service technician or customer service representative.

2. ENVIRONMENT

This chair should be used only in a well ventilated, normally dry and dust free environment.

3. RESTRICTIONS

People with osteoporosis, heart disease and heart pacemakers, pregnancies, injuries or any other health related issues should consult their doctor before using this massage chair.

Stop immediately the use of this massage chair if you feel unwell and consult your doctor.



4. MAINTENANCE

- This product should only be maintained by **iComfort**® certified technicians. Otherwise, EBI reserves the right to void the warranty.
- Disconnect the power cord after use.
- Make sure the wall outlet is in good working order before use.
- If this chair will not be used for an extended period of time, store in a dry and dustless environment.
- Avoid chair exposure to high temperatures and direct sunlight.
- Clean this product with a dry cloth. Do not use thinner, benzene or alcohol.
- When moving the chair on wood floor, rough ground or in a narrow space two people should lift the chair together.
- We recommend to use the massage chair intermittently and not for long time periods.

5. TROUBLESHOOTING

- It is normal for the motor to make noise while in use.
- If the controller doesn't work normally, please check that the plug and socket are properly connected and the switch is turned on.
- When the programmed working time is over, the chair will power-off automatically.
- After several use, the chair might power-off because of overheat. It can be used again after half an hour of cooling time.

6. FEATURES AND BENEFITS

Enjoy a full en invigorating massage with the iComfort® ic1020 massage chair. You will feel as if you had your very own massage therapist. The Body Scanning Technology actually maps the back of each individual user in order to provide a customized massage. The handy retractable footrest gives you maximum configuration options. The iComfort® ic1020 massage chair reproduces over 6 massage actions all with the sensation of a professional massage in the comfort of your very own home! The iComfort® ic1020 massage chair will provide you with many years of soothing massage and comfort.

- Contemporary design with high-quality soft touch leatherette.
- 6 massage modes: kneading, Shiatsu, Rolling, Knocking, Knap and vibration to create some of the best massages you have ever felt.



- Sophisticated leg and foot massage.
- 15 airbags for a complete massage experience.
- 4 head rotating massage mechanism for smooth wrist movement simulation.
- Built-in MP3 player, USB Key, SD card amplifier and headphones with music synchronization.
- The LCD backlit remote control indicates the type, speed, intensity and area of the massage being performed.
- Power recline feature up to 165 degrees with separate recline/incline controls.
- Retractable footrest.

7. INSTALLATION

The **ic1020 massage chair** comes partly assembled.

- Assemble this massage chair according to the installation instructions provided in this guide.
- Check the parts list carefully to make sure nothing is missing.
- Sitting in the massage chair before it is completely assembled could result in permanent damage to the chair and personal injury.

This massage chair is equipped with a cord having a grounding conductor. The AC connector must be plugged into an appropriate socket that is properly installed and grounded.

If the massage chair fuse is burned out, please turn the chair off and unplug the power. You can open the lid covering the fuse located in the switch box at the bottom of the chair in the back.

- A) Unplug the chair from the AC wall outlet.
- B) Unscrew the fuse cover underneath and behind the chair.
- C) Remove the fuse and replace it with an identical fuse type then screw back the fuse cover.

You can call iComfort® at 1-866-967-7333 ext 227 if you need help.

CAUTION: Never substitute a missing part with one of your own. If a part is missing, contact customer service at: 1-866-967-7333 ext 227

**STEP 1: Unpacking**

1. Remove the massage chair from the box.
2. Remove all plastic wraps from the massage chair, cushions, bags, etc.

When positioning the chair, make sure there are at least 60 cm of free space behind the backrest and 60 cm of space in front of the footrest.

STEP 2: Install the back cushion and pillow pad.

The back and its cushion are connected by a zipper



The pillow pad and the back cushion are connected by a velcro strip

**STEP 3: Install the remote control stand**

1. Install the remote control on the right side of the massage chair using the small predrilled holes with the supplied screws.
2. Insert the remote control on the stand.
3. You can adjust both the vertical and horizontal angle of the remote control for better viewing.



STEP 4: Install the coffee table stand

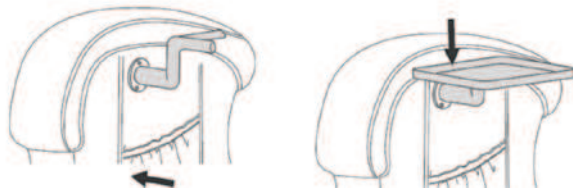

1. Install the coffee table stand on the left side of the massage chair using the small predrilled holes with the supplied screws.
2. Install the coffee table on top of the stand using the predrilled holes with the supplied screws.

STEP 5: Final Installation

1. Insert the AC power cord into the wall outlet
2. Turn on the main power switch on the lower back behind the massage chair (The LCD on the remote control will light up).
3. Enjoy a comfortable massage



8. COMPONENTS

Massage chair

Front view

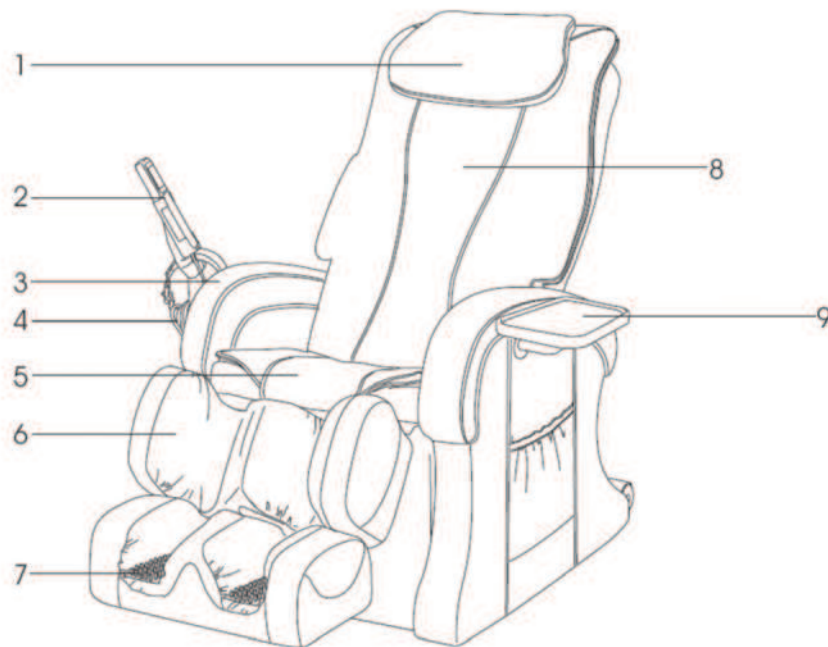

- | | |
|--------------------------|-------------------------|
| 1. Detachable pillow pad | 6. Calf massage section |
| 2. Remote control | 7. Foot massage section |
| 3. Armrest | 8. Back cushion |
| 4. Headphone | 9. Coffee table |
| 5. Seat cushion | |



Back View

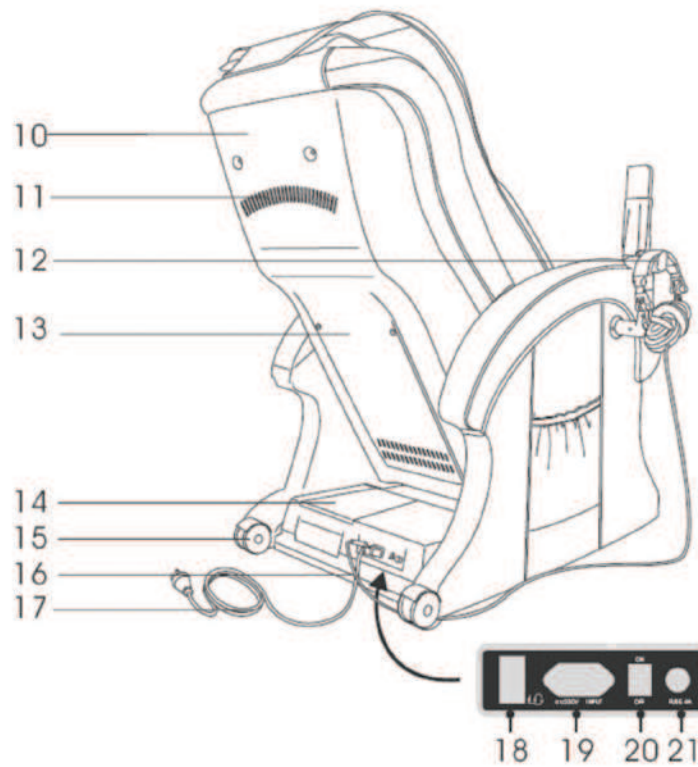

- 10. Back cover
- 11. Ventilation holes
- 12. Remote control stand
& headphone holder
- 13. Back cover
- 14. MP3 player compartment

- 15. Wheels
- 16. Massage chair base
- 17. AC cable
- 18. Headphone connector
- 19. AC cable connector
- 20. Main On/Off switch



21. Fuse box

Remote control



9. OPERATION

1. Once the massage chair is connected to a wall outlet, turn on the power switch behind the massage chair at the bottom. The remote control will light up.

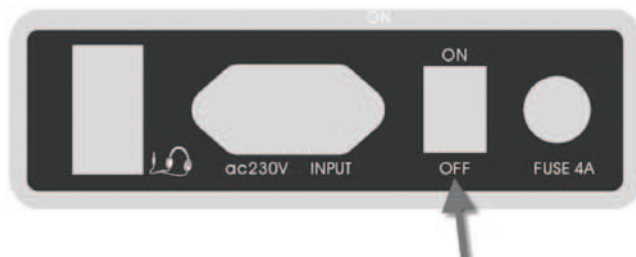

2. Adjust the legs and backrest angle at the desired position using the buttons at the bottom of the remote control. This will ensure the correct massage mechanism's positioning.





Leg and back section angle adjustments: You can adjust the angle of the leg section by pressing on the leg up or down button.



You can also adjust both the leg and back section simultaneously for the desired seating position.



3. Press the power 'On' switch on the remote control. Once activated, the **ic1020 massage chair** will 'measure' the length of your spine and after about 7 seconds start the automatic full body massage. Pressing again turns off the chair.



9. 1. AUTOMATIC MESSAGE ADJUSTMENTS

Back massage area: You can choose a specific massage area for the back during the automatic massage mode. Upper body (full back), Neck & shoulder (upper back) or back waist (lower back).

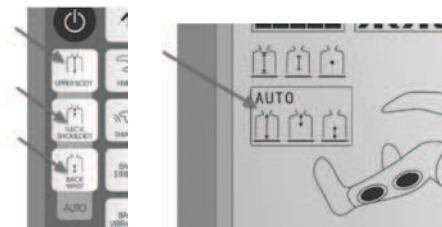



9. 2. MANUAL MESSAGE MODE

You can activate the manual message mode at any time during the automatic message mode. Press on the desired message type: Knead, Flap, Knead and Flap, Shiatsu or knock. Then select the message speed (5 speed choices) and the message width (3 choices between normal, narrow and large).

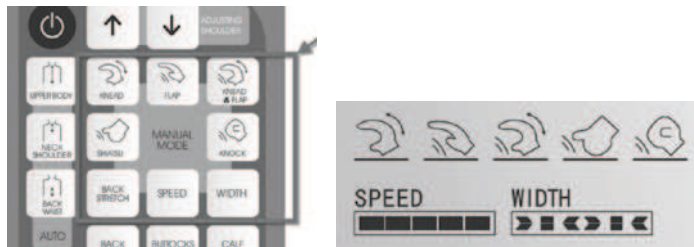

Shoulder height: To choose a specific message area on the back, press the upward or downward button.



The Back Stretch button: to further complement the manual message mode, this button will activate the movement the message mechanism down and then up to simulate stretching.

9. 3. OTHER MESSAGE FUNCTIONS

The ic1020 has many other message functions that you can use during the automatic or manual message mode.

Vibration message mode: You can add a vibration message to the back, buttocks and calf area during the automatic or manual message modes.



There are two intensity levels of vibration for each area displayed with the following symbols:

Back vibration



Buttocks vibration



Calf vibration



Lower body airbag massage mode: You can adjust, change or remove the lower body airbag massage feature during the automatic or manual massage mode.



Pressing on the **Airbag** button will activate or deactivate the lower body airbag massage feature. Activation is displayed on the screen of the remote control.



Pressing on the **Mode** button repeatedly will activate one of the four airbag massage modes during the automatic massage mode or during a manual massage mode. Each mode concentrates the airbag massage in a different area.

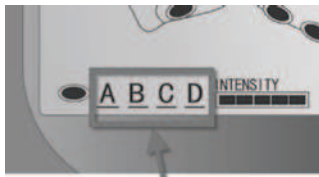

You can press on the **Intensity** button if you desire to decrease or increase the airbag pressure (intensity). There are two adjustments level.



During the automatic and manual massage mode, the remote control display will indicate where the airbags are activated.

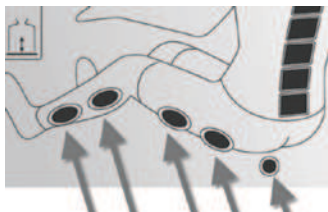

9. 4. MP3 MUSIC FEATURE

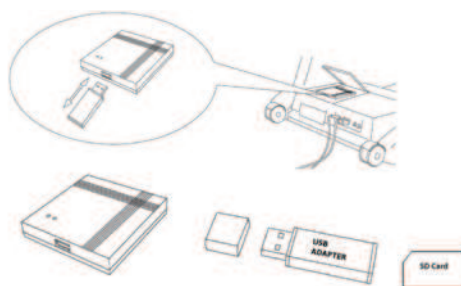



The MP3 music player is situated at the back of the **ic1020**.

1. Insert the provided SD memory card into the back of the USB adapter.
2. Insert the USB adapter with the SD memory card into a USB port on a PC computer (Windows XP, 2000, NT and Windows 7). The SD memory card will be recognized as a removable disk.
3. Download or drag your favorite MP3 type songs from your PC into the SD memory card.
4. Disconnect safely the USB adapter with the SD memory card from the PC.
5. Turn off the power of the massage chair and open the cover of the MP3 box behind the chair.
6. Insert the SD memory card into the SD card port of the MP3 box and put the MP3 box back to its original location. Close the cover of the MP3 box.
7. Turn on the power of the massage chair.

To play your favorite music using the provided headphones, use the dedicated buttons on the remote control. Pressing on the play button will play the first song.

Pressing again will stop the MP3 player.



Press on the previous music tune button to play the previous music tune.



Press on the next music tune button to play the next music tune.





The **music synchronization feature** will adjust the vibration massage to function at the same rhythm as the music being played. This adds to the enjoyment of the massage experience. Pressing again on this button will deactivate the feature.

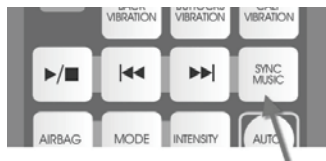

Note: There are already a few MP3 music files on the provided SD memory card. They can be erased if you prefer.

Automatic original positioning feature: When the automatic massage mode or manual massage is finished, you can press on both the 'Auto' and 'leg down' button. The **ic1020** will then return to its original position. The back section will completely go up and the leg section will completely come down.



10. FLOOR PROTECTION

Prolonged use of this massage chair can damage wood floors. In order to prevent permanent damage, place a carpet or protective mat under the chair.





11. MOVING THE CHAIR

Disconnect the power cord and headphones and place them on the massage chair seat. Lift the leg and foot section until you feel the chair moving forward or backward easily. The chair should be tilted up to about 30 degrees.

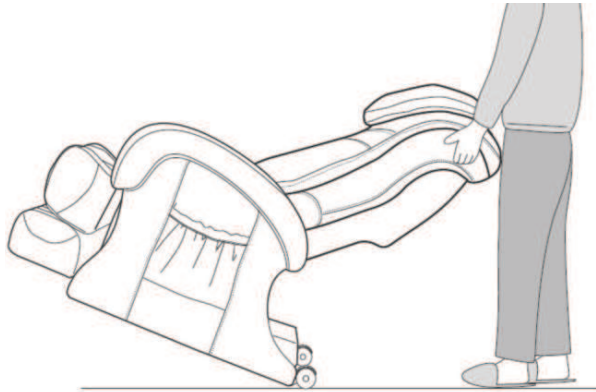

12. PRODUCT SPECIFICATIONS

Weight Net: 105kgs

Dimensions: 77 cm x 167 cm x 73.5 cm

Power: 180 Watts

Voltage: 110V, 60 Hz



13. WARRANTY

LIMITED ONE (1) YEAR WARRANTY

This product is guaranteed against all manufactured faults and defects for a period of One (1) year from the date of purchase.

For repairs or product defects, please call our customer service department at: 1-866-967-7333 ext 227. Please have your proof of purchase on hand. If we are not able to replace your defective part, we will send you a service technician for repairs.

Important notes: Any damages caused by an accident or an abusive usage are **NOT** covered under warranty. We also decline all responsibility concerning indirect or consecutive damages. In certain Canadian provinces, it is not permitted to limit indirect or consecutive damages. Therefore it is possible these limitations are not applicable to you. This warranty gives you specific legal rights. You may also have other legal rights which vary from one province to another.



Imported by
EBI Inc. (iComfort)
 120 Boul des Entreprises
 Boisbriand, Québec, Canada J7G 2T3
 1-866-967-7333
 www.ebiweb.ca
 Made in China

CUSTOMER SERVICE: 1-866-967-7333 ext 227

You can also fill out the registration card on our website at www.iComfort.ca



Warranty Registration card
Carte d'enregistrement de garantie



<input type="text"/>		<input type="text"/>	
First Name - Prénom		Last Name - Nom	
<input type="text"/>		<input type="text"/>	
Address - Adresse	City - Ville	Prov.	Postal Code - Code Postal
<input type="text"/>		<input type="text"/>	
Tel - Tél.	Email - Courriel		

Purchase Date - Date d'achat

Purchased From - Acheté de

Serial Number - Numéro de série

Send to - Expédier à :

EBI
 120 Boul. des Entreprises,
 Boisbriand (Québec) J7G 2T3
 Tel - Tél. : 1-866-967-7333 Ext. 227
 Fax - Téléc. : 450-420-2180

Warranty must be active within 30 days of purchase.
La garantie doit être enregistrée dans les 30 jours suivant l'achat.

Date

Signature