

tactio™

USER'S MANUAL

ALTERA-04G



**ADSL2+ Wireless Router Modem
Integrated 4 port Switch**

Rev.2.01

Table of Contents:

FCC Part 68	1
FCC Part 15	1
Chapter 1	Introduction.....	2
Chapter 1.1	Overview.....	2
Chapter 1.2	Features.....	2
Chapter 1.3	System Requirement	3
Chapter 2	Installation.....	4
Chapter 2.1	Checklist.....	4
Chapter 2.2	The Front LEDs.....	4
Chapter 2.3	The Rear Ports.....	4
Chapter 2.4	Hardware installation.....	5
Chapter 3	Configuration.....	7
Chapter 3.1	Determine your connection settings.....	7
Chapter 3.2	Connecting the ADSL Router to your network.....	7
Chapter 3.3	Configuring with Web Browser.....	7
Chapter 3.3.1	Quick Setup Guide.....	9
Chapter 3.3.2	System Time.....	13
Chapter 3.3.3	Admin Setting	13
Chapter 3.3.4	Firmware Update.....	14
Chapter 3.3.5	System Log.....	14
Chapter 3.3.6	System Reset.....	15
Chapter 3.4.1	ADSL Status.....	15
Chapter 3.4.2	ADSL Statistics.....	16
Chapter 3.4.3	VC Configuration.....	16
Chapter 3.5.1	WAN Configuration.....	17
Chapter 3.5.2	WAN Status.....	18
Chapter 3.5.3	DNS.....	18
Chapter 3.5.4	DDNS.....	19
Chapter 3.6.1	LAN Configuration.....	20
Chapter 3.7.1	Wireless Settings.....	21
Chapter 3.7.2	Wireless Security.....	22
Chapter 3.8.1	IP Filtering.....	23
Chapter 3.9.1	NAT Setting.....	24
Chapter 3.9.2	Virtual Server.....	25
Chapter 3.9.3	DMZ Setting.....	26
Chapter 3.9.4	ADSL type Setting.....	26
Chapter 3.10.1	Static Routing.....	27
Chapter 3.10.2	Dynamic Routing.....	28
Chapter 3.10.3	Routing Table.....	29
Chapter 3.11.1	System Status.....	30
Appendix A	Glossary.....	31
Appendix B	Cabling / Connection.....	36
Declaration of CE	37

FCC Part 68

This equipment complies with Part 68 of the FCC Rules. On the bottom of this equipment is a label that contains the FCC Registration Number and Ringer Equivalence Number (REN) for this equipment. You must provide this information to the telephone company upon request.

The REN is useful to determine the quantity of devices you may connect to the telephone line and still have all of those devices ring when your number is called. In most, but not all areas, the sum of the REN of all devices connected to one line should not exceed five (5.0). To be certain of the number of devices you may connect to your line, as determined by the REN, you should contact your local telephone company to determine the maximum REN for your calling area.

If the modem causes harm to the telephone network, the telephone company may discontinue your service temporarily. If possible, they will notify you in advance. But if advance notice isn't practical, you will be notified as soon as possible. You will be advised of your right to file a complaint with the FCC.

The telephone company may make changes in its facilities, equipment, operations, or procedures that could affect the proper operation of your equipment. If they do, you will be notified in advance to give you an opportunity to maintain uninterrupted telephone service.

If you experience trouble with this modem, please contact your dealer for repair/warranty information. The telephone company may ask you to disconnect this equipment from the network until the problem has been corrected or you are sure that the equipment is not malfunctioning.

This equipment may not be used on coin service provided by the telephone company. Connection to party lines is subject to state tariffs.

Installation

This device is equipped with a USOC RJ11C connector.

FCC Part 15

The modem generates and uses radio frequency energy. If it is not installed and used properly in strict accordance with the user's manual, it may cause interference with radio and television reception. The modem has been tested and found to comply with the limits for Class B computing devices in accordance with the specifications in Subpart B, Part 15 of the FCC regulations. These specifications are designed to provide reasonable protection against such interference in a residential installation. However, there is no guarantee that interference will not occur in a particular installation. FCC regulations require that shielded interface cables be used with your modem.

If interference does occur, we suggest the following measures be taken to rectify the problem:

- 1) Move the receiving antenna.
- 2) Move the modem away from the radio or TV.
- 3) Plug the modem into a different electrical outlet.
- 4) Discuss the problem with a qualified radio / TV technician.

CAUTION:

Changes or modifications not expressly approved by the party responsible for compliance to the FCC Rules could void the user's authority to operate this equipment.

Cable connections:

All equipment connected to this modem must use shielded cable as the interconnection means.

Notes:

Operation is subject to the following two conditions:

- 1) This device may not cause harmful interference, and
- 2) This device must accept any interference received including interference that may cause undesired operation.

Chapter 1 Introduction

The ADSL2+ Router provides home connectivity to an ADSL service provider network over an ADSL/Asynchronous Transfer Mode (ATM) physical layer.

The router can run upstream maximum transmission rates of 2Mbps and downstream maximum transmission rates of 24Mbps.

The actual rate depends on the copper category of your telephone wire, distance from the central office and the type of ADSL2+ service subscribed.

Four ports switch is provided for connection to an Ethernet LAN or Ethernet-equipped PC, and this router is easy to install and to configure.

1.1 Overview

The ADSL2+ Router is optimized to address the growing demand for high-speed Internet access, and it does so as a single, highly-integrated and cost-effective solution.

1.2 Features

- ADSL2/2+ Compliance
 - Compliant with ADSL standards
 - Full-rate ANSI.413 Issue 2 , ITU G.dmt (G.992.1) , G.dmt bis (G.992.3) and G.adslplus(G.992.5) standards
 - Splitter less ITU G.lite (G.992.2) specification
 - Annex A (ADSL over POTS) and Annex B (ADSL over ISDN), compliant to ETSI TS 101 388
 - DMT modulation and demodulation
 - Full-rate adaptive modem
 - Maximum downstream rate of 24 Mbps
 - Maximum upstream rate of 2 Mbps
 - Tone detection for low power mode
 - Supports splitter less ADSL implementation
 - Interoperable with all major DSLAM equipment
- ATM Protocols
 - WAN mode support: PPP over ATM (RFC 2364) and PPP over Ethernet (RFC 2516)
 - LAN mode support: bridged/routed Ethernet over ATM (RFC 2684) and classical IP over ATM (RFC 1577)
 - Up to 8 VCs (virtual circuits)
 - ATM SAR (segmentation and reassembly)
 - ATM AALC (adaption layer type 5)
- Bridge Mode
 - Ethernet to ADSL self learning Transparent Bridging (IEEE 802.1D)
 - Supports MAC learning addresses
- Router Mode
 - IP routing-RIPv2
 - Static routing
 - DNS Proxy
 - Dynamic DNS
 - DMZ
 - Port Forwarding
 - DHCP (dynamic host configuration protocol) server and client
 - NAT (network address translation)
 - ICMP (Internet control message protocol)
- Security
 - Stateful packet inspection and filtering
 - Intrusion detection and protection
 - PAP (password authentication protocol)
 - CHAP (challenge authentication protocol)
 - Password protected system management
- Ethernet Interface
 - Compliant with IEEE 802.3 and 802.3u 10/100 Mbps

- HTTP Web-Based Management
 - Firmware upgrade by UI
 - Customizable Web pages
 - WAN and LAN side connection statistics
 - Configuration of static routes and routing table
 - Password protected access
 - System log
 - Configuration of VCs (virtual circuits)

1.3 System Requirements

- 1) Personal computer (PC)
- 2) Pentium II 233 MHz processor minimum
- 3) 32 MB RAM minimum
- 4) 20 MB of free disk space minimum
- 5) Ethernet Network Interface Controller (NIC) RJ45 Port
- 6) Internet Browser

Chapter 2 Installation

This chapter offers information about installing your router. If you are not familiar with the hardware or software parameters presented here, please consult your service provider for the values needed.

2.1 Checklist

Check the shipping box carefully to ensure that the contents include the items you ordered. If any of the items are missing or damaged, contact your local distributor. The contents of your carton may vary depending on your service provider.

Contents description

- 1) ADSL2+ Router for home/office use.
- 2) ADSL2+ Router Installation and Operation Guide (this publication)
- 3) Power supply with 9Vdc / 1.5 Ampere power adapter
- 4) ADSL cable RJ-11 telephone cable (6 ft)
- 5) Ethernet cable Ethernet category 5 twisted pair cable (6 ft)

2.2 The Front LEDs

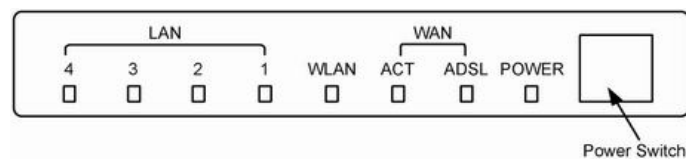

LED	State	Description
POWER	ON	When the router is powered on and in ready state
	Flashing	The router is in booting stage
ADSL	ON	"Showtime" successful connection between ADSL modem and telephone company's network
	Flashing	"Handshaking" modem is trying to establish a connection to telco's network
ACT	Flashing	Data is transferred between router and Internet
WLAN	Flashing	When wireless AP is ready
LAN	ON	Link
	Flashing	TX or RX activity
1-4	OFF	No Link These four LAN (Local Area Network) ports are where you will connect networked devices, such as PCs, print servers remote hard drives, and anything else you want to put on your network

2.3 The Rear Ports



Connector	Description
POWER	Power connector with 9VDC/ 1.5 Ampere
Reset Switch	The reset button, the router restore the default settings when press this button until reboot
LAN (1-4)	Router is successfully connected to a device through the corresponding port (1, 2, 3 or 4). If the LED is flashing, the Router is actively sending or receiving data over that port.
ADSL Connector	The RJ-11 connector allows data communication between the modem and the ADSL network through a twisted-pair phone wire

2.4 Hardware installation

This section describes how to connect and configure the ADSL2+ Router.

Step 1. Connect the ADSL Line

Connect the router directly to the wall jack using the included ADSL cable.

Step 2. Connect a Workstation to the Router's LAN port

There are two methods to connect the router and workstation. The one use the crossover Ethernet cable to connect directly between them. The other use straight Ethernet cable to connect router with hub (or switch), then go to the workstation.

Step 3. Connect the Power Adapter to the Router

Connect the power adapter to the port labeled POWER on the rear panel of router.

Step 4. Connect All Cables to the Network

The procedure for connecting cables differs depending on whether or not your telephone equipment is connected to a POTS splitter.

POTS Splitter Configuration (ADSL over POTS)

A POTS splitter separates data signals from voice signals on your telephone line. The POTS splitter works by running a separate data line from the voice line, so that the ADSL router has a dedicated cable for data transmission. Figure 2-3.1 and 2-3.2 shows how to connect all cables to the Router.

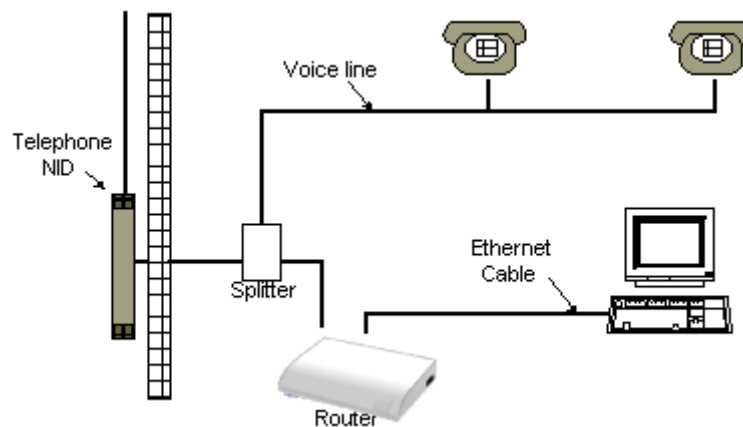

Figure 2-4.1 Router Connected through a POTS Splitter

Note: The POTS splitter may also be installed on the outside of the house adjacent to the telephone network interface device (NID).

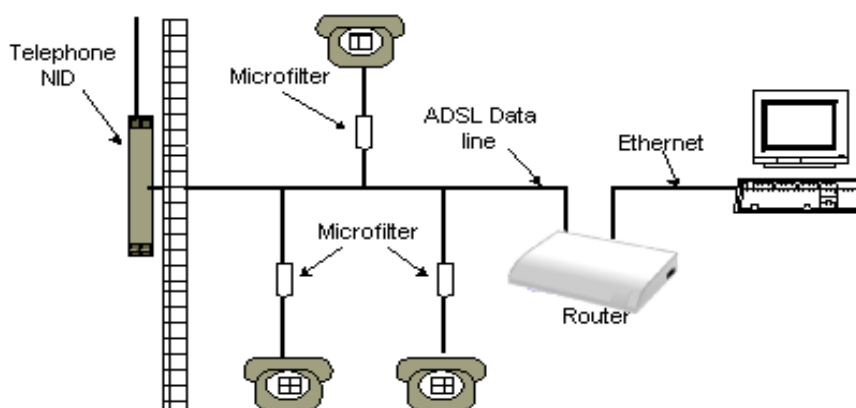

Figure 2-4.2 Router Connected through several micro-filters

ISDN Splitter Configuration (ADSL over ISDN)

A ISDN splitter separates ADSL signals from ISDN signals on your ISDN telephone line. The ISDN splitter works by running a separate ADSL line from the ISDN line, so that the ADSL router has a dedicated cable for data transmission. Figure 2-3.3 shows how to connect all cables to the Router.

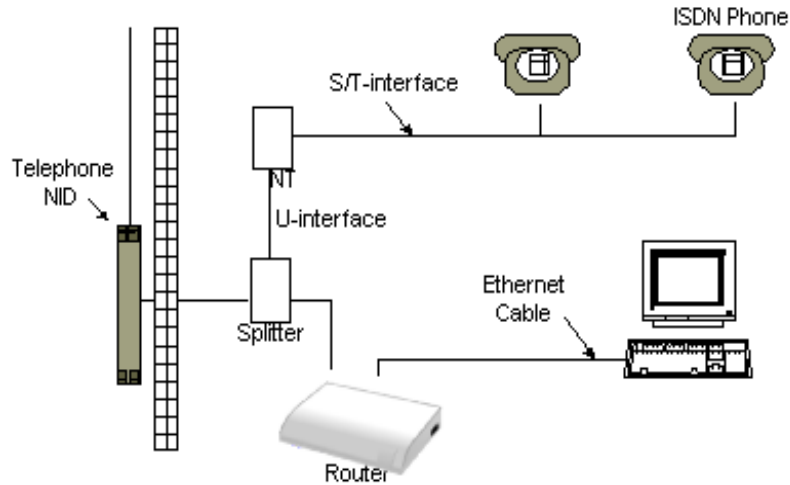

Figure 2-4.3 Router Connected through a ISDN Splitter

Note: The ISDN splitter may also be installed on the outside of the house adjacent to the telephone network interface device (NID).

Chapter 3 Configuration

3.1 Determine your connection settings

Before you configure the router, you need to know the connection information supplied by your ADSL service provider.

3.2 Connecting the ADSL Router to your network

Unlike a simple hub or switch, the setup of the ADSL Router consists of more than simply plugging everything together. Because the Router acts as a DHCP server, you will have to set some values within the Router, and also configure your networked PCs to accept the IP Addresses the Router chooses to assign them. Generally there are several different operating modes for your applications. And you can know which mode is necessary for your system from ISP. These modes are router, bridge, PPPoE+NAT and NAT and PPPoA+NAT.

3.3 Configuring with Web Browser

It is advisable to change the administrator password to safeguard the security of your network.

To configure the router, open your browser, type '**http://192.168.16.1**' into the address bar and click 'Go' to get to the login page. Save this address in your Favorites for future reference.



At the User name prompt, type '**admin**'. And the Password prompt, type '**admin**'. You can change these later if you wish. Click '**OK**'.



http://192.168.16.1/ - Microsoft Internet Explorer

File Edit View Favorites Tools Help

Address http://192.168.16.1

tactio™

ADSL2+ Router

Status	Quick Start	Interface Setup	Advanced Setup	Access Management	Maintenance	Status	Help
	Device Info	System Log	Statistics				

Device Information

Firmware Version (0420) : 2.7.0.26(RUE0.B1)3.5.10.5
 MAC Address : 00:05:b4:04:23:fc

LAN

IP Address : 192.168.16.1
 Subnet Mask : 255.255.255.0
 DHCP Server : Enabled

WAN

Virtual Circuit :
 Status : Not Connected
 Connection Type : PPPoE
 IP Address : 0.0.0.0
 Subnet Mask : 0.0.0.0
 Default Gateway : 0.0.0.0
 DNS Server : 0.0.0.0

ADSL

ADSL Firmware Ver : FwVer:3.5.10.5_A_TC3084 HwVer:T14.F7_0.0
 Line State : Down
 Modulation : Multi-Mode
 Annex Mode : ANNEX_A

Done Internet

3.3.1 Quick Setup Guide

You can use **"Quick Setup"** to setup the router as follows, and the router will connect to the Internet via ADSL line.

Click **"Quick Start"** to get into the quick setup procedures.

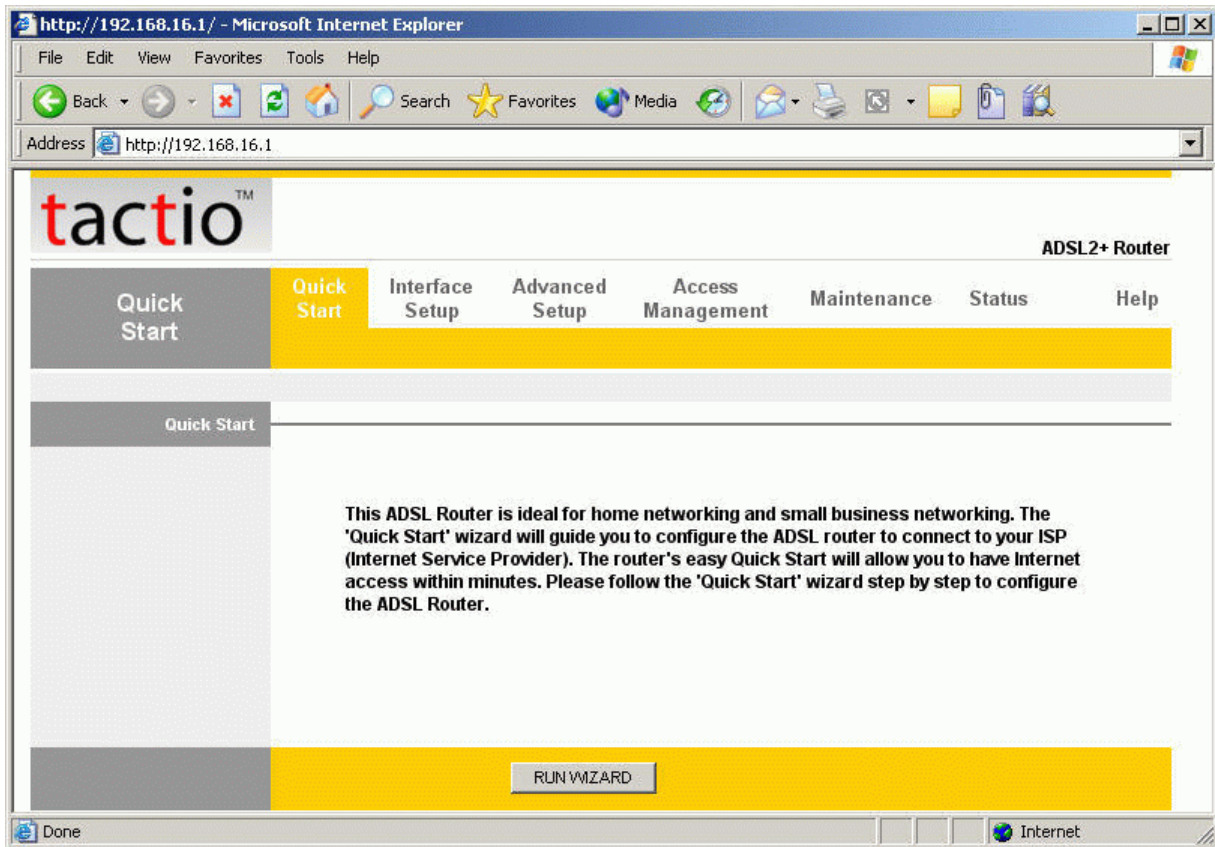

Click **"RUN WIZARD"** to start up this procedure.

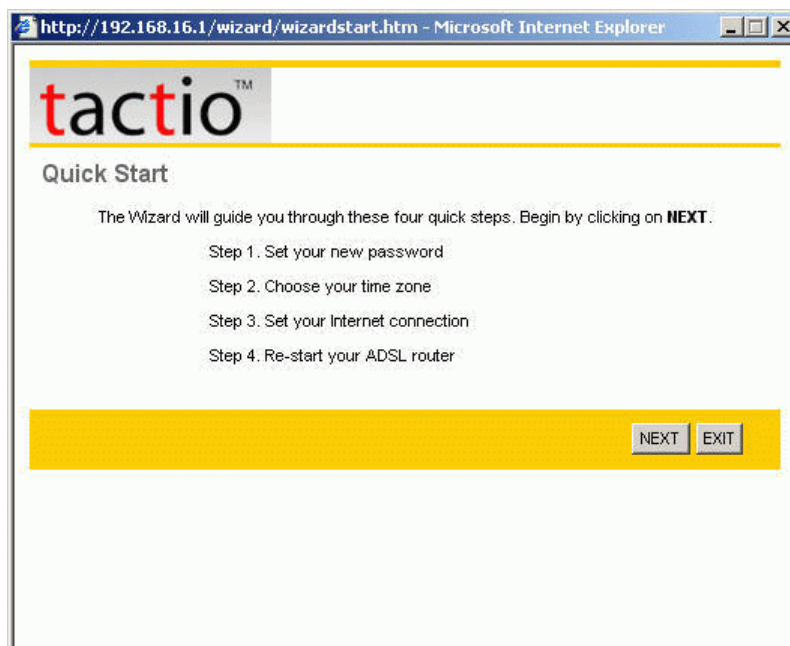

Step 1 - Click **"Next"** to setup your new administrator's password.



The screenshot shows a web browser window with the URL `http://192.168.16.1/wizard/wizardpwd.htm`. The page features the Tactio logo at the top. Below the logo, the heading "Quick Start - Password" is displayed. The main text reads: "You may change the **admin** account password by entering in a new password. Click **NEXT** to continue." There are two input fields: "New Password:" and "Confirmed Password:", both containing five dots. At the bottom of the page, there is a yellow bar with three buttons: "BACK", "NEXT", and "EXIT".

Step 2 - Click "**Next**" to setup your time zone.

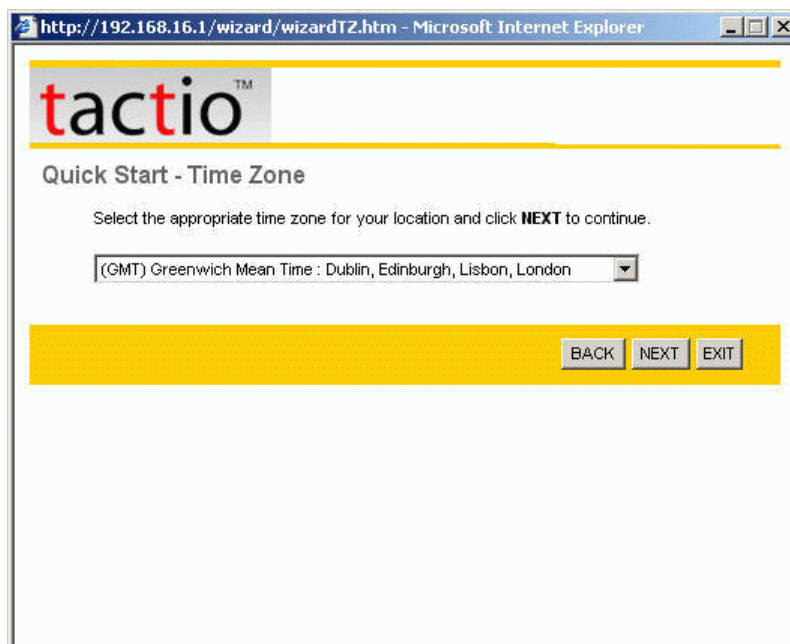

The screenshot shows a web browser window with the URL `http://192.168.16.1/wizard/wizardTZ.htm`. The page features the Tactio logo at the top. Below the logo, the heading "Quick Start - Time Zone" is displayed. The main text reads: "Select the appropriate time zone for your location and click **NEXT** to continue." There is a dropdown menu showing "(GMT) Greenwich Mean Time : Dublin, Edinburgh, Lisbon, London". At the bottom of the page, there is a yellow bar with three buttons: "BACK", "NEXT", and "EXIT".

Step 3 - Click "**Next**" to setup your Internet connection type. You can have this information from your Internet Service Provider.

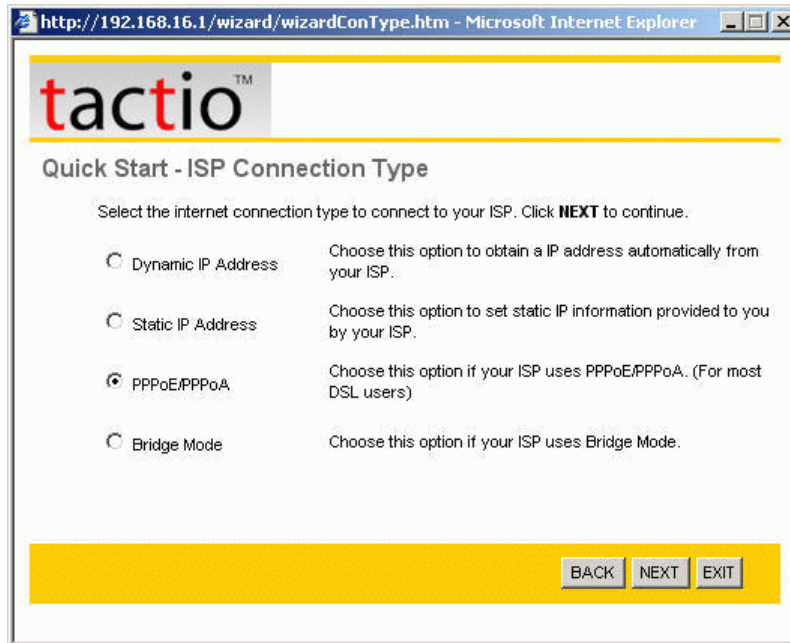

http://192.168.16.1/wizard/wizardConType.htm - Microsoft Internet Explorer

tactioTM

Quick Start - ISP Connection Type

Select the internet connection type to connect to your ISP. Click **NEXT** to continue.

Dynamic IP Address Choose this option to obtain a IP address automatically from your ISP.

Static IP Address Choose this option to set static IP information provided to you by your ISP.

PPPoE/PPPoA Choose this option if your ISP uses PPPoE/PPPoA. (For most DSL users)

Bridge Mode Choose this option if your ISP uses Bridge Mode.

BACK NEXT EXIT

Enter the connection information provided by your ISP.



http://192.168.16.1/wizard/wizardPPP.htm - Microsoft Internet Explorer

tactioTM

Quick Start - PPPoE/PPPoA

Enter the PPPoE/PPPoA information provided to you by your ISP. Click **NEXT** to continue.

Username:

Password:

VPI: (0~255)

VCI: (1~65535)

Connection Type:

BACK NEXT EXIT

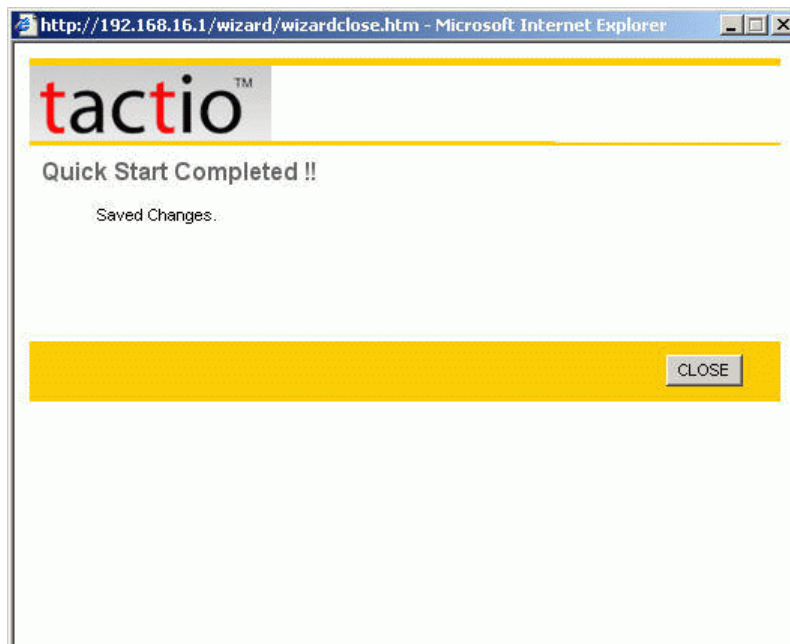
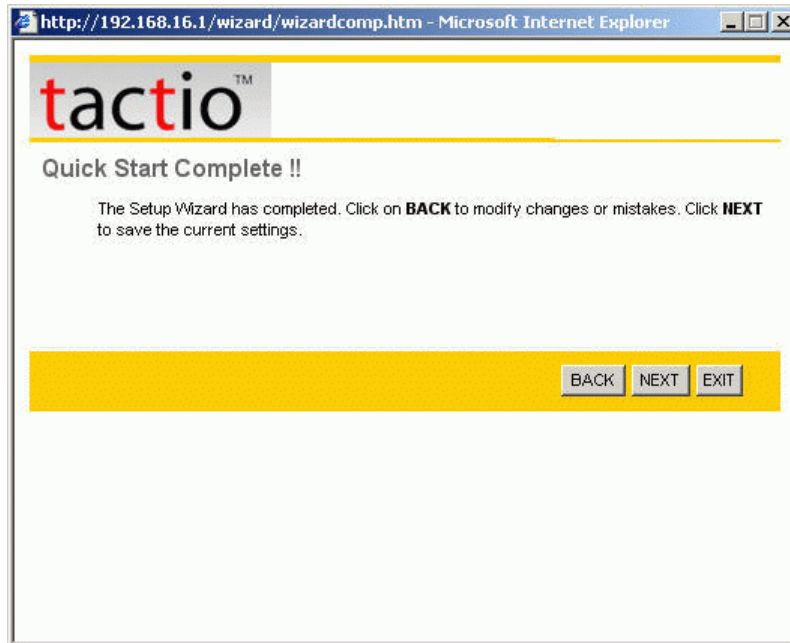

3.3.2 System Time

Go to **Maintenance->Time Zone** and select system time as you wish.

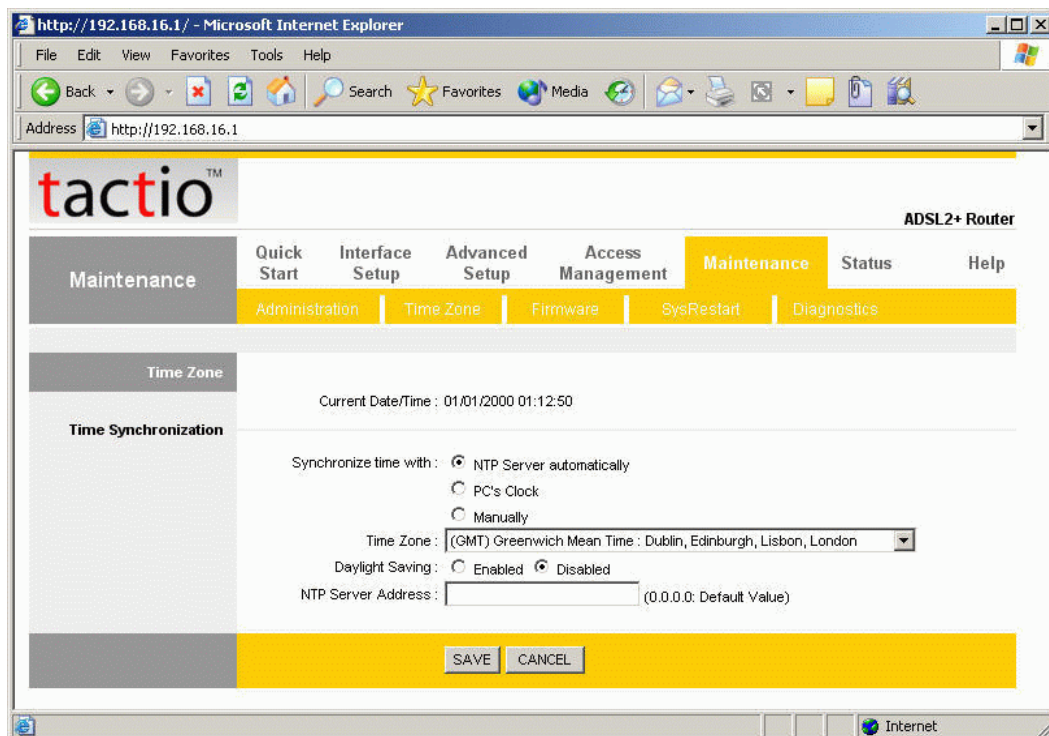

Connecting to a Simple Network Time Protocol (SNTP) server allows the router to synchronize the system clock to the global Internet. The synchronized clock in the router is used to record the security log and control client filtering.

3.3.3 Admin Setting

Go to **Maintenance-> Administration** to set a new user's name and password to restrict management access to the router.

The default is **admin (User's name)** and **admin (Password)**

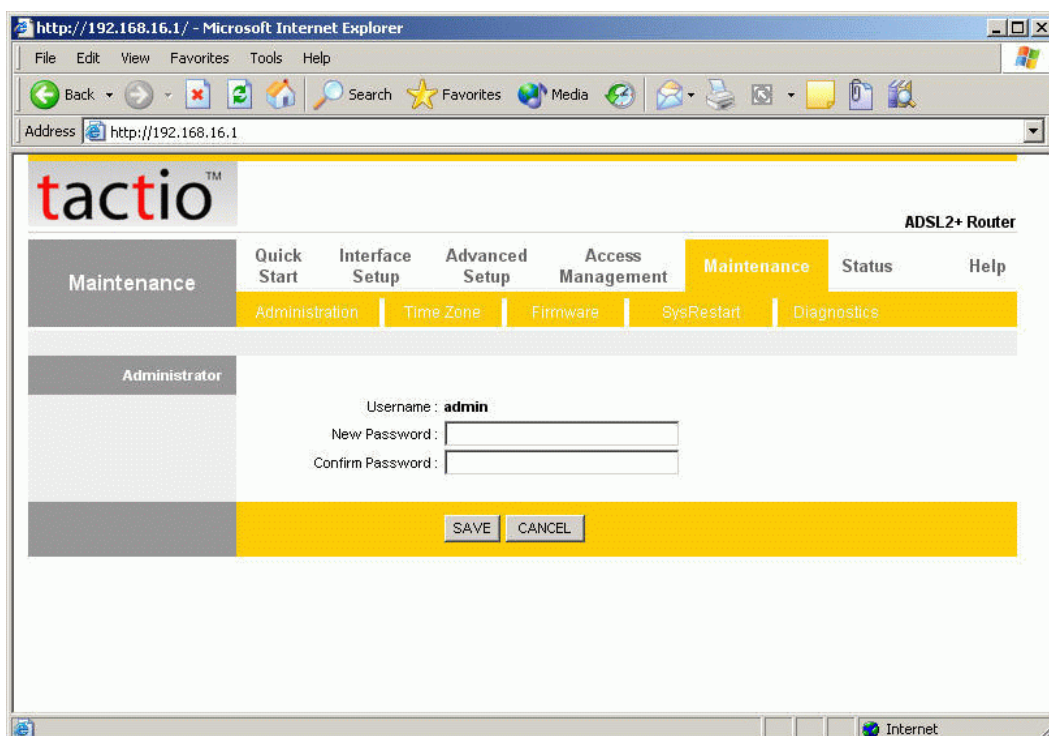

3.3.4 Firmware Update

Go to **Maintenance** -> **Firmware** to upgrade the firmware. The new firmware for your router can improve functionality and performance. Enter the path and name of the upgrade file then click the **UPGRADE** button below. You will be prompted to confirm the upgrade.

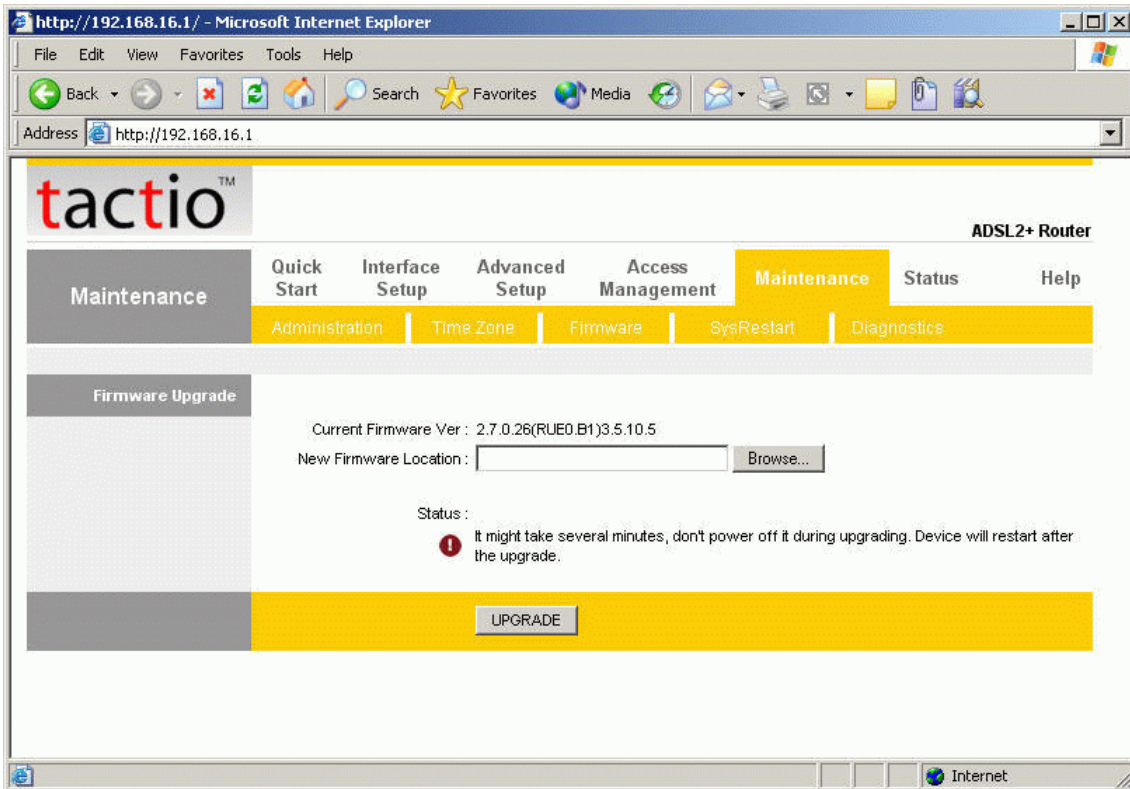

3.3.5 System Log

Go to **Status** -> **System Log** and you can see the system log file. Click "**Save Log**" to save system log file.

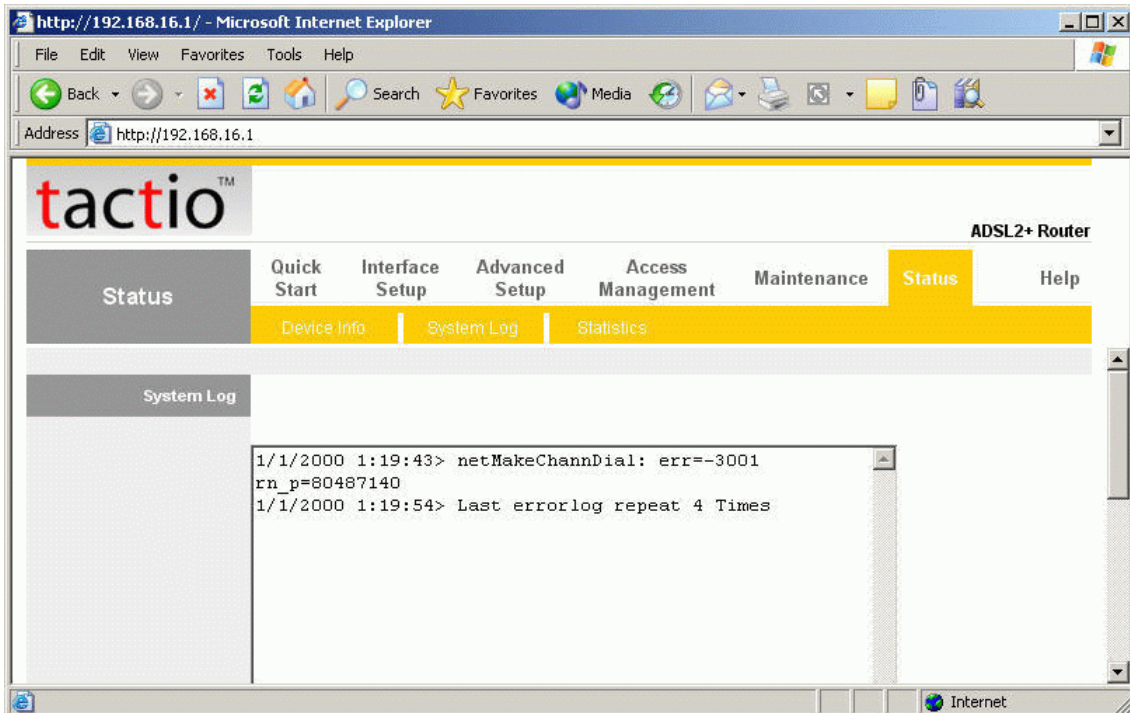

3.3.6 System Reset

In the event that the router stops responding correctly or in some way stops functioning, you can perform a reset. Your settings will not be changed. To perform the reset, select "**Current Setting**" and click on the "**RESTART**" button below. The router will reboot with current setting.

Select "**Factory Default Setting**" and click on the "**RESTART**" button, the router will reboot with factory default settings.

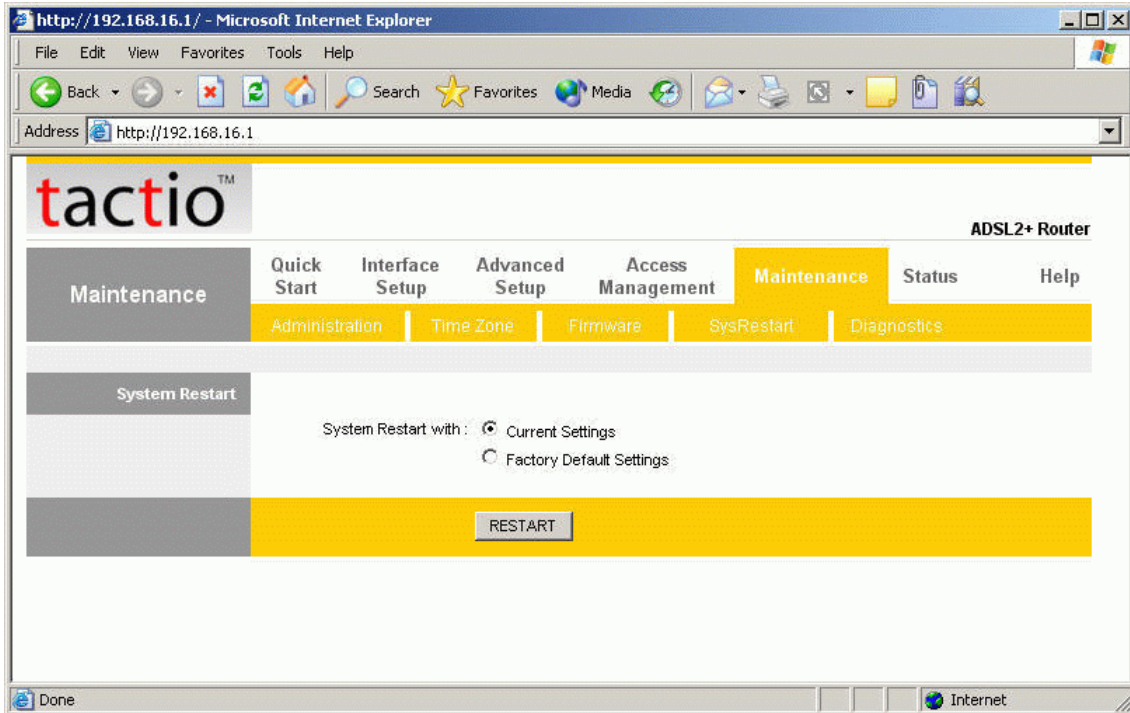

3.4.1 ADSL Status

Go to **Status->Device Info**. The 'ADSL Line Status' enables you to check the status of your ADSL connection including how fast data is being transferred.

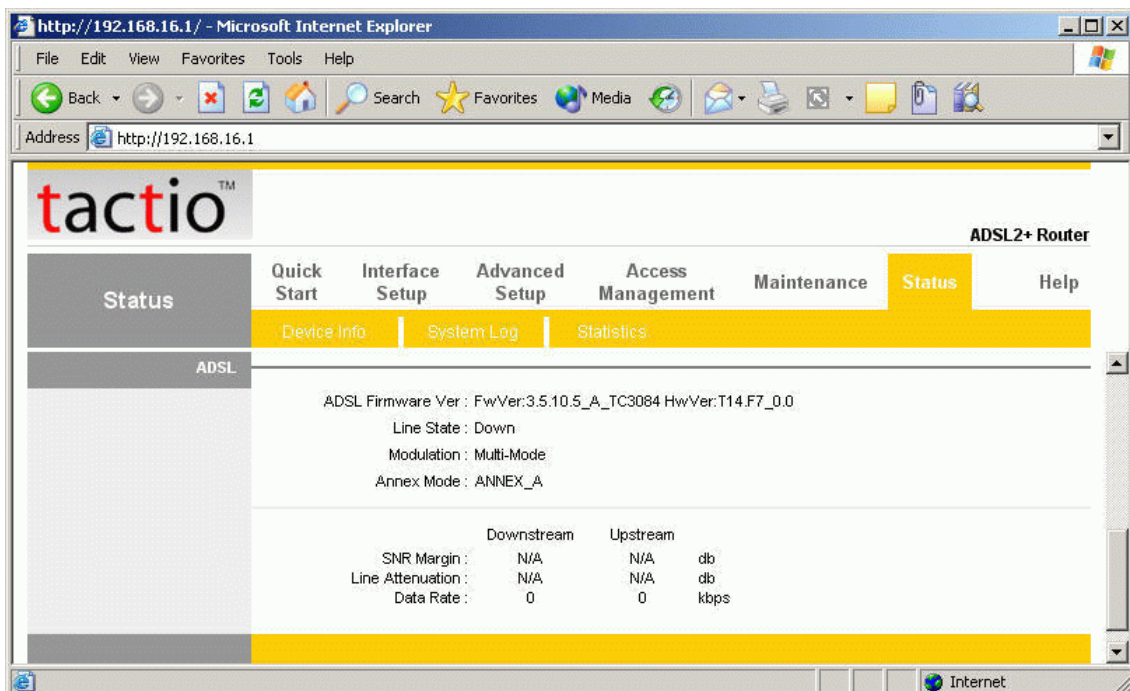

3.4.2 ADSL Statistics

Go to **Status-> Statistics** and select **ADSL** interface. You can see the traffic Statistics of ADSL interface.

The screenshot shows the Tactio ADSL2+ Router web interface. The browser address bar shows `http://192.168.16.1`. The navigation menu includes 'Status', 'Quick Start', 'Interface Setup', 'Advanced Setup', 'Access Management', 'Maintenance', and 'Help'. The 'Status' menu is expanded, showing 'Device Info', 'System Log', and 'Statistics'. The 'Traffic Statistics' section is active, showing the interface selected as 'ADSL'. Below this, there are two tables: 'Transmit Statistics' and 'Receive Statistics'.

Transmit Statistics		Receive Statistics	
Transmit total PDUs	0	Receive total PDUs	0
Transmit total Error Counts	0	Receive total Error Counts	0

A 'REFRESH' button is located at the bottom of the statistics section.

3.4.3 VC Configuration

Go to **Interface Setup -> Internet**. To add or delete ADSL VC configuration, these information provide by ISP.

The screenshot shows the Tactio ADSL2+ Router web interface. The browser address bar shows `http://192.168.16.1`. The navigation menu includes 'Interface', 'Quick Start', 'Interface Setup', 'Advanced Setup', 'Access Management', 'Maintenance', 'Status', and 'Help'. The 'Interface Setup' menu is expanded, showing 'Internet', 'LAN', and 'Wireless'. The 'Virtual Circuit' configuration section is active, showing the interface selected as 'Internet'.

Virtual Circuit: PVC0 (dropdown) [PVCs Summary](#)

Status: Activated Deactivated

VPI: 0 (range: 0~255)

VCI: 35 (range: 1~65535)

ATM QoS: UBR (dropdown)

PCR: 0 cells/second

SCR: 0 cells/second

MBS: 0 cells

3.5.1 WAN Configuration

Go to **Interface Setup -> Internet**. The router can be connected to your service provider in any of the following ways.

Dynamic IP Address: Obtain an IP address automatically from your service provider.

Static IP Address: Uses a static IP address. Your service provider gives a static IP address to access Internet services.

PPPoE: PPP over Ethernet is a common connection method used for xDSL

PPPoA: PPP over ATM is a common connection method used for xDSL

Bridge: Bridge mode is a common connection method used for xDSL modem.

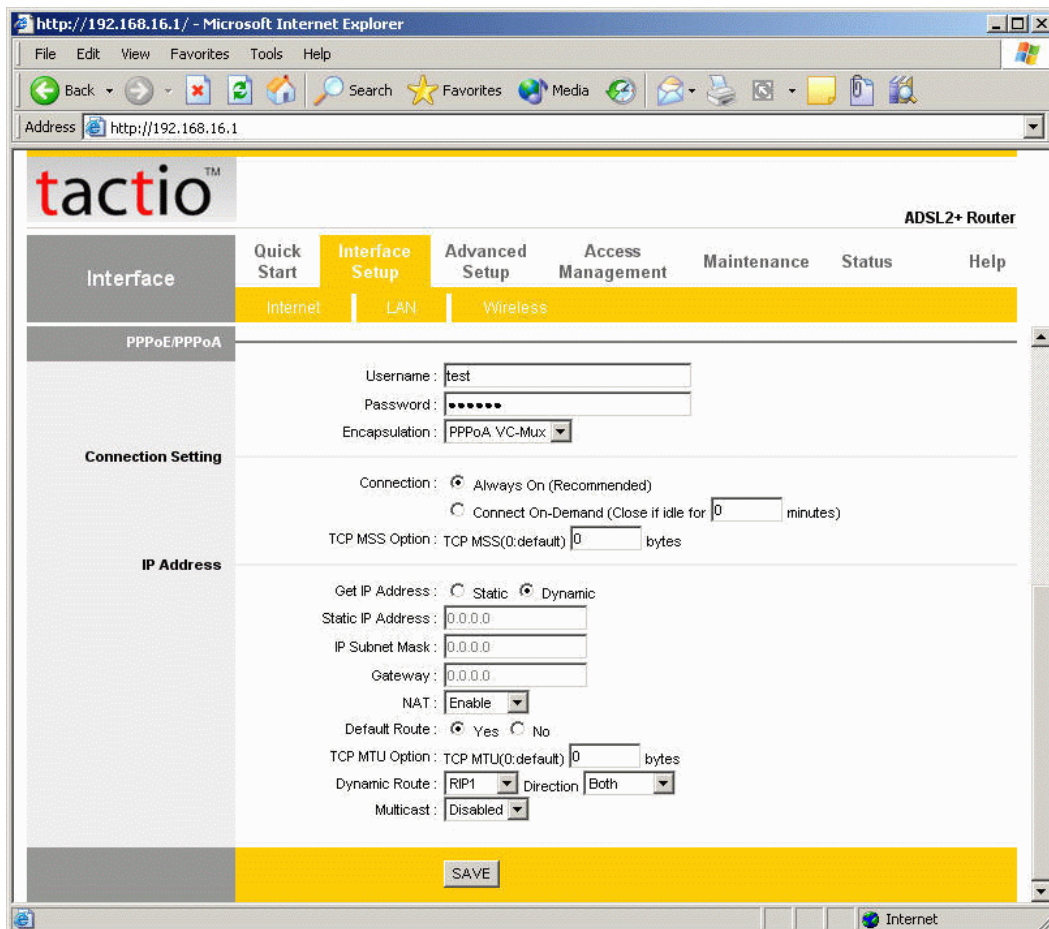
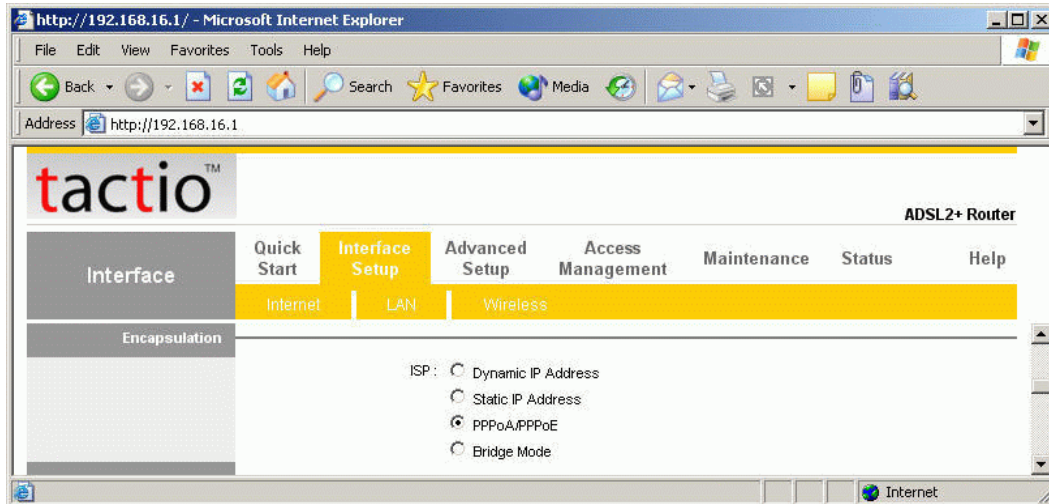

3.5.2 WAN Status

Go to **Status** -> **Device Info** and select the **Virtual Circuit** to see the connection status.

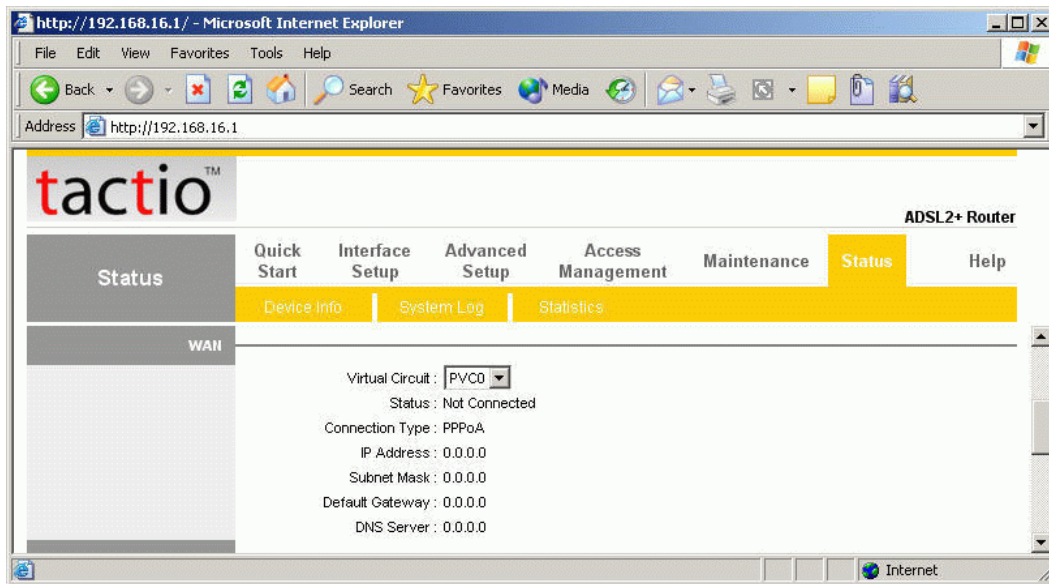

3.5.3 DNS

Go to **Interface** -> **LAN** to enable DHCP server. Then you can set DNS server for the router. A Domain Name system (DNS) server is like an index of IP addresses and Web addresses. If you type a Web address into your browser, a DNS server will find that name in its index and find the matching IP address. Most ISPs provide a DNS server for speed and convenience. Since your Service Provider may connect to the Internet with dynamic IP settings, it is likely that the DNS server IP addresses are also provided dynamically. However, if there is a DNS server that you would rather use, you need to specify the IP address below.

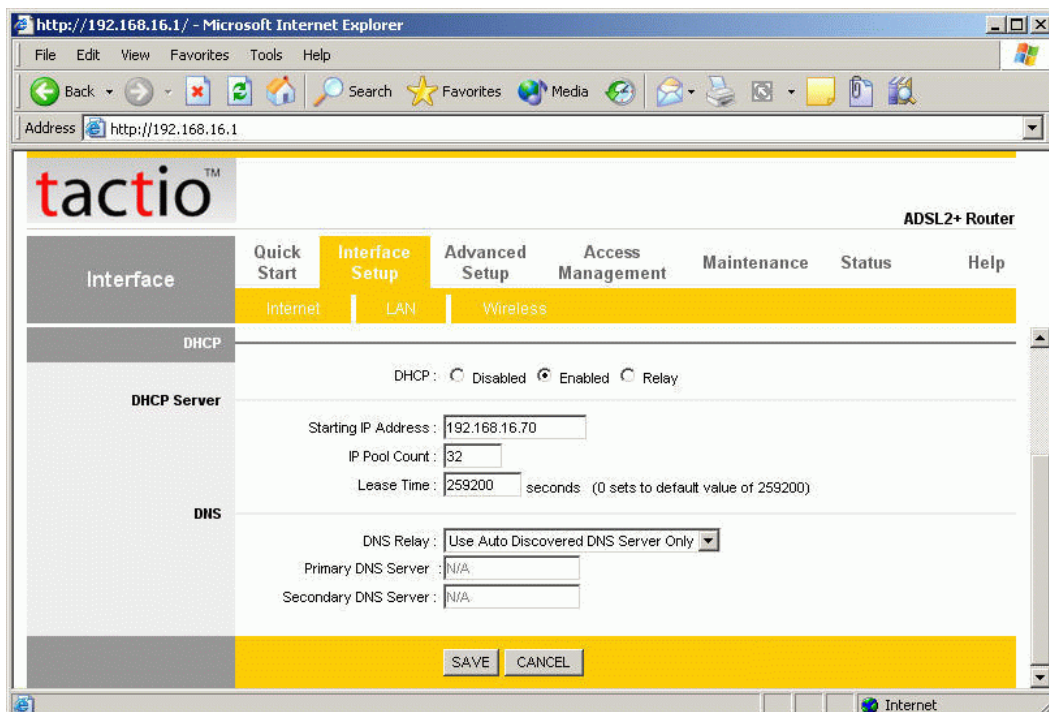

3.5.4 DDNS

Go to **Access Management -> DDNS** to setup your DDNS parameters. Dynamic DNS allows you to update your dynamic IP address with one or many dynamic DNS services. So anyone can access your FTP or Web service on your computer using DNS-like address.

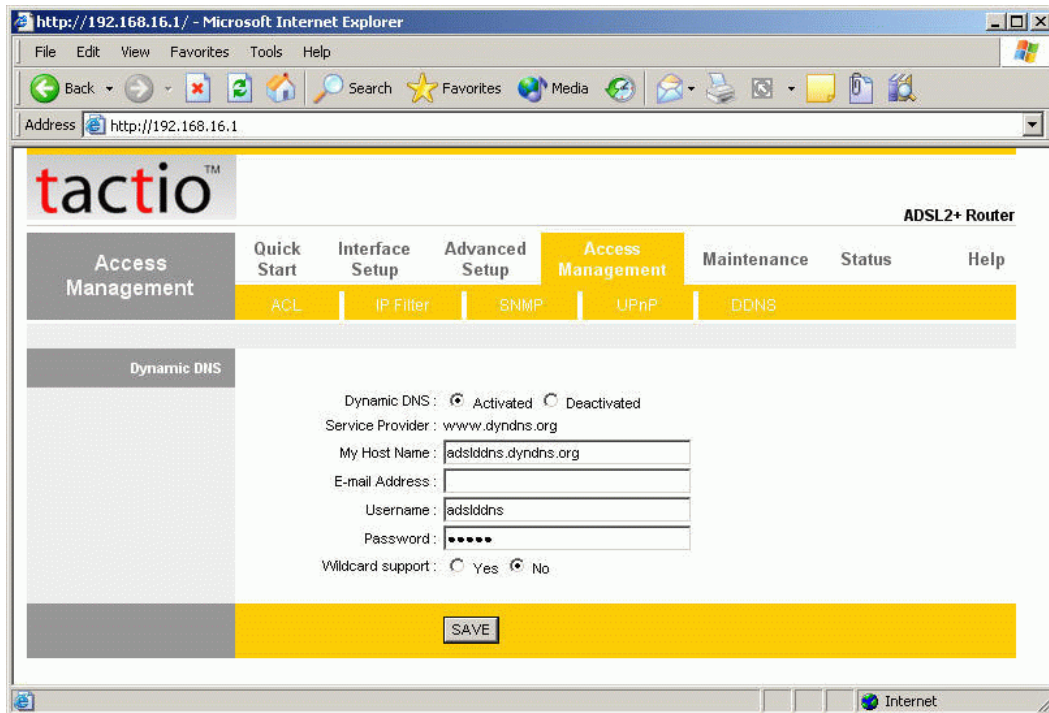

The screenshot shows the Tactio ADSL2+ Router web interface in Microsoft Internet Explorer. The browser address bar shows `http://192.168.16.1/`. The page title is "tactio™ ADSL2+ Router". The navigation menu includes "Access Management", "Quick Start", "Interface Setup", "Advanced Setup", "Access Management", "Maintenance", "Status", and "Help". The "Access Management" menu is expanded, showing sub-items: "ACL", "IP Filter", "SNMP", "UPnP", and "DDNS". The "Dynamic DNS" section is active, displaying the following configuration options:

- Dynamic DNS: Activated Deactivated
- Service Provider: `www.dyndns.org`
- My Host Name: `adslddns.dyndns.org`
- E-mail Address:
- Username: `adslddns`
- Password:
- Wildcard support: Yes No

A "SAVE" button is located at the bottom of the configuration area.

3.6.1 LAN Configuration

Go to Interface **Setup** -> **LAN**. The 'LAN Settings' option enables you to configure the LAN port.

If the DHCP Relay is selected, the DHCP requests from local PCs are forward to the DHCP server runs on WAN side. To have this function working properly, disable the NAT to run on router mode only, disable the DHCP server on the LAN port, and make sure the routing table has the correct routing entry.

The screenshot shows the Tactio ADSL2+ Router web interface in Microsoft Internet Explorer. The browser address bar shows `http://192.168.16.1`. The interface has a navigation menu with tabs: Interface, Quick Start, Interface Setup (selected), Advanced Setup, Access Management, Maintenance, Status, and Help. Under 'Interface Setup', there are sub-tabs for Internet, LAN (selected), and Wireless.

The main configuration area is divided into sections:

- Router Local IP:**
 - IP Address:
 - IP Subnet Mask:
 - Dynamic Route: Direction:
 - Multicast:
- DHCP:**
 - DHCP: Disabled Enabled Relay
- DHCP Server:**
 - Starting IP Address:
 - IP Pool Count:
 - Lease Time: seconds (0 sets to default value of 259200)
- DNS:**
 - DNS Relay:
 - Primary DNS Server:
 - Secondary DNS Server:

At the bottom of the configuration area, there are **SAVE** and **CANCEL** buttons.

3.7.1 Wireless Settings

Go to **Interface -> Wireless** to setup the wireless parameters.

SSID

The identifier for the network. You can change the SSID. Only devices with the same SSID can interconnect.

Channel ID

The channel number is used for wireless networking. The channel setting of the wireless devices within a network should be the same.

http://192.168.16.1/ - Microsoft Internet Explorer

File Edit View Favorites Tools Help

Address http://192.168.16.1/

tactio™ ADSL2+ Router

Interface **Quick Start** **Interface Setup** Advanced Setup Access Management Maintenance Status Help

Internet LAN **Wireless**

Wireless LAN

Access Point: Activated Deactivated
 SSID:
 Broadcast SSID: Yes No
 Channel ID:
 Security Type:

Advanced Setting

Beacon Interval: (range: 20~1000)
 RTS/CTS Threshold: (range: 1500~2347)
 Fragmentation Threshold: (range: 256~2346, even numbers only)
 DTIM: (range: 1~255)
 802.11 b/g:

Wireless MAC Address Filter

Active: Activated Deactivated
 Action: the follow Wireless LAN station(s) association.
 Mac Address #1:
 Mac Address #2:
 Mac Address #3:
 Mac Address #4:
 Mac Address #5:
 Mac Address #6:
 Mac Address #7:
 Mac Address #8:

Internet

3.7.2 Wireless Security

Go to **Interface -> Wireless** to setup the wireless security.

The Authentication type supports "shared key WEP 64bits", "shared key WEP 128bits", "WPA-PSK".

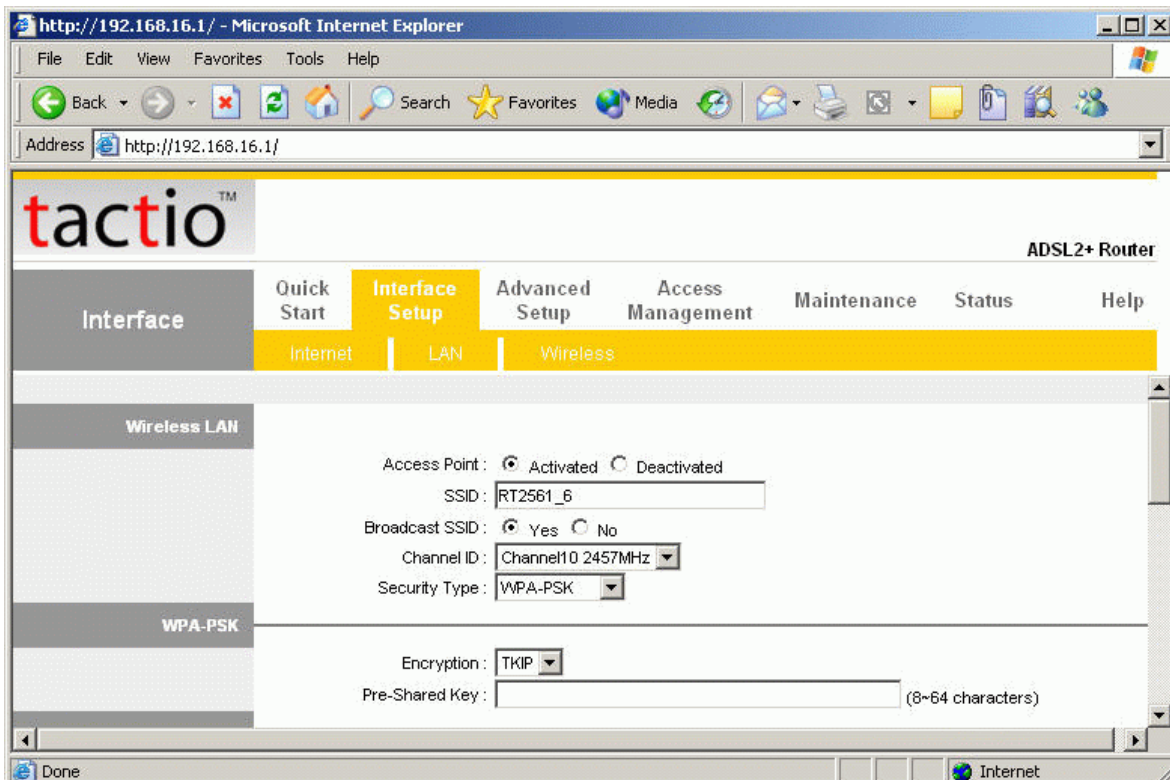
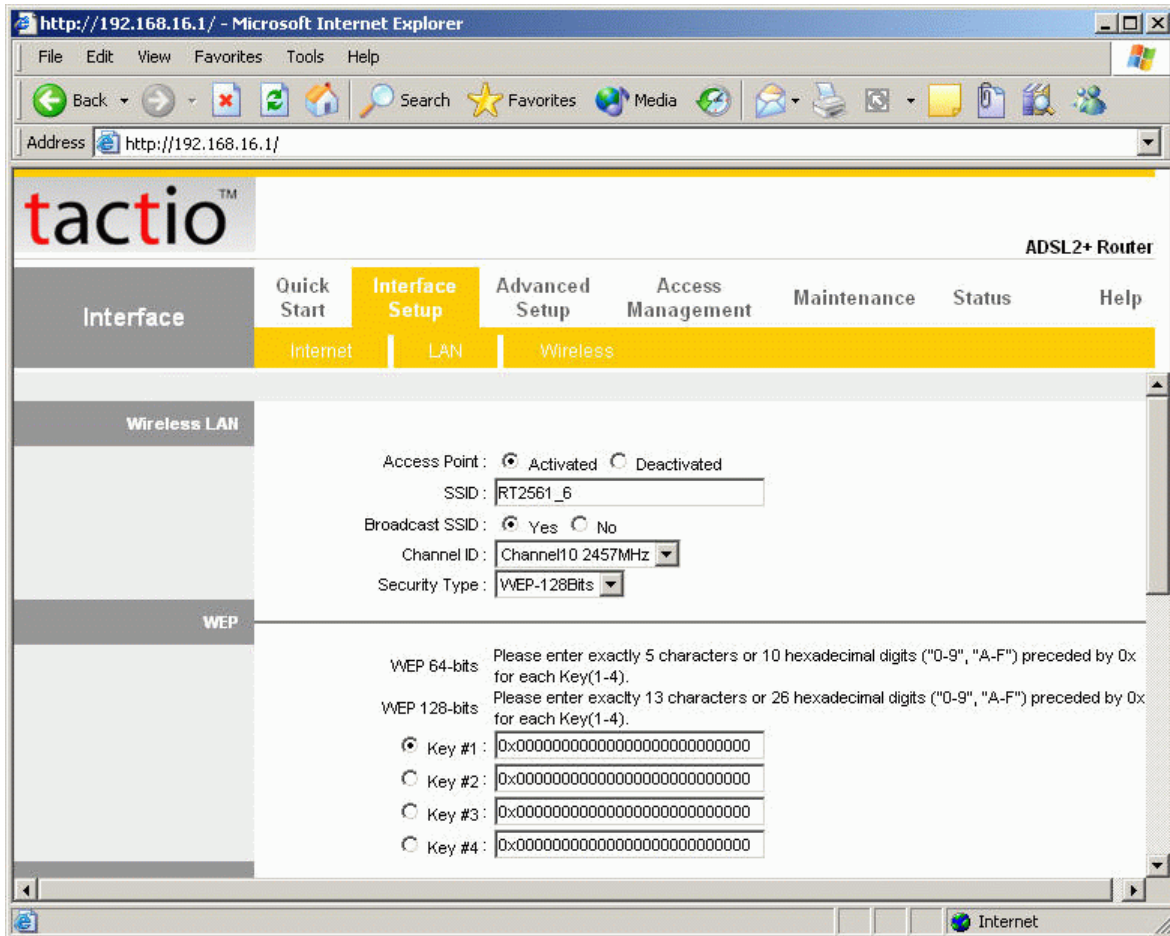

3.8.1 IP Filtering

Go to **Access Management -> IP Filter** to block some packets from WAN.

The router provides extensive firewall protection by restricting connection parameters to limit the risk of intrusion and defending against a wide array of common hacker attacks.

“Block WAN Scan” allow you to prevent the hackers from testing the services of the router. To add IP filtering rules to block certain packet from WAN.

http://192.168.16.1/ - Microsoft Internet Explorer

File Edit View Favorites Tools Help

Address http://192.168.16.1

tactio™ ADSL2+ Router

Access Management Quick Start Interface Setup Advanced Setup **Access Management** Maintenance Status Help

ACL IP Filter SNMP UPnP DDNS

IP Filter

IP Filter Set Editing

IP Filter Set Index: 1
Interface: PVC0
Direction: Both

IP Filter Rule Editing

IP Filter Rule Index: 1
Active: Yes No

Source IP Address: (0.0.0.0 means Dont care)
Subnet Mask:
Port Number: 0 (0 means Dont care)

Destination IP Address: (0.0.0.0 means Dont care)
Subnet Mask:
Port Number: 0 (0 means Dont care)

Protocol: TCP
Rule Unmatched: Forward

IP Filter Listing

IP Filter Set Index: 1 Interface: - Direction: -

#	Active	Src IP/Mask	Dest IP/Mask	Src Port	Dest Port	Protocol	Unmatched
1	-	-	-	-	-	-	-
2	-	-	-	-	-	-	-
3	-	-	-	-	-	-	-
4	-	-	-	-	-	-	-
5	-	-	-	-	-	-	-
6	-	-	-	-	-	-	-

SAVE DELETE CANCEL

Internet

3.9.1 NAT Setting

Go to **Advanced Setup->NAT** to setup the NAT features. Network Address Translation (NAT) allows multiple users at your local site to access the Internet through a single public IP address or multiple public IP addresses. NAT can also prevent hacker attacks by mapping local addresses to public addresses for key services such as the Web or FTP.

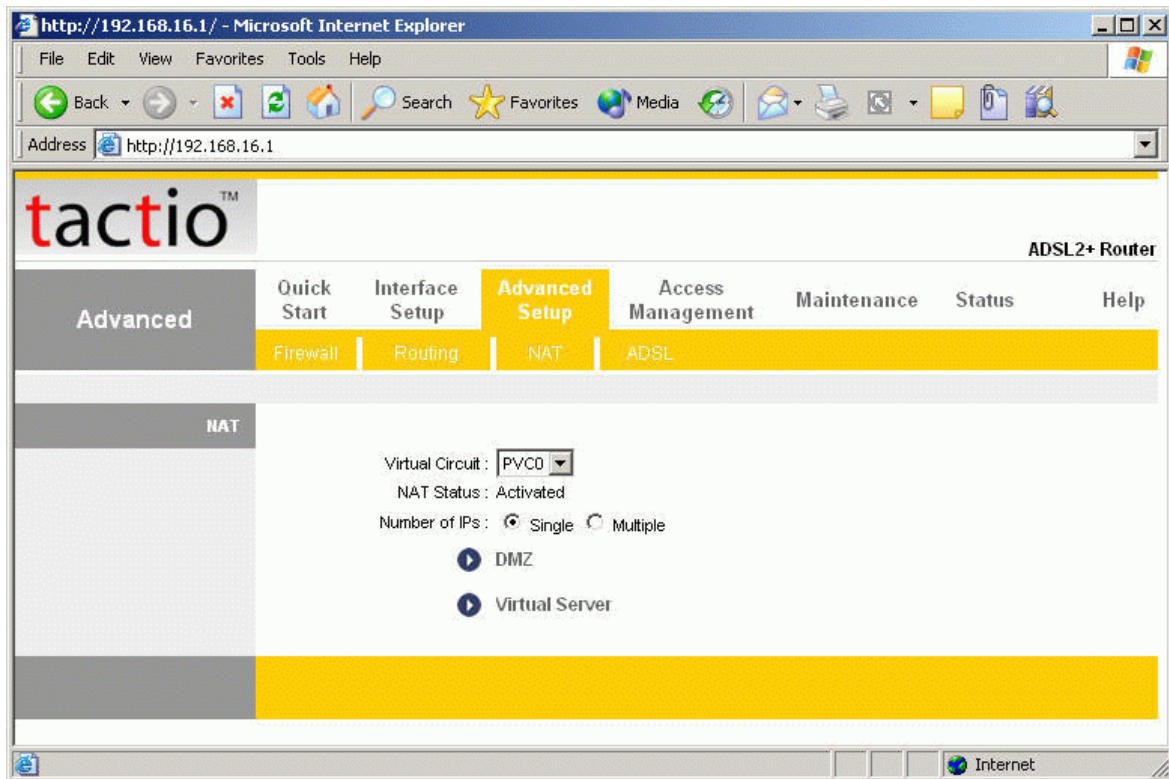

3.9.2 Virtual Server

Go to **Advanced Setup -> NAT -> Virtual Server** to set virtual server as you need. (Known as Port Mapping).

You can configure the router as a virtual server so that remote users accessing services such as the Web or FTP at your local site via public IP addresses can be automatically redirected to local servers configured with private IP addresses. In other words, depending on the requested service (TCP/UDP port numbers), the router redirects the external service request to the appropriate server (located at another internal IP address). For some applications, you need to assign a set or a range of ports (example 4000-5000) to a specified local machine to route the packets. The router allows the user to configure the needed port mappings to suit such applications.

The screenshot shows the Tactio ADSL2+ Router web interface. The browser address bar shows `http://192.168.16.1/`. The page title is "tactio ADSL2+ Router". The navigation menu includes "Advanced", "Quick Start", "Interface Setup", "Advanced Setup", "Access Management", "Maintenance", "Status", and "Help". Under "Advanced Setup", there are sub-menus for "Firewall", "Routing", "NAT", and "ADSL".

The "Virtual Server" configuration section is active. It shows "Virtual Server for : Single IP Account". The "Rule Index" is set to 1. The "Start Port Number" and "End Port Number" are both set to 0. The "Local IP Address" is set to 0.0.0.0.

Below the configuration form is a "Virtual Server Listing" table with the following data:

Rule	Start Port	End Port	Local IP Address
1	0	0	0.0.0.0
2	0	0	0.0.0.0
3	0	0	0.0.0.0
4	0	0	0.0.0.0
5	0	0	0.0.0.0
6	0	0	0.0.0.0
7	0	0	0.0.0.0
8	0	0	0.0.0.0
9	0	0	0.0.0.0
10	0	0	0.0.0.0
11	0	0	0.0.0.0
12	0	0	0.0.0.0
13	0	0	0.0.0.0
14	0	0	0.0.0.0
15	0	0	0.0.0.0
16	0	0	0.0.0.0

At the bottom of the page, there are four buttons: "SAVE", "DELETE", "BACK", and "CANCEL".

3.9.3 DMZ Setting

Go to **Advanced Setup** -> **NAT** -> **DMZ** to set DMZ parameters.

If you have a local client PC that cannot run an Internet application properly from behind the NAT firewall, you can open the client up to unrestricted two-way Internet access by defining a virtual DMZ Host.

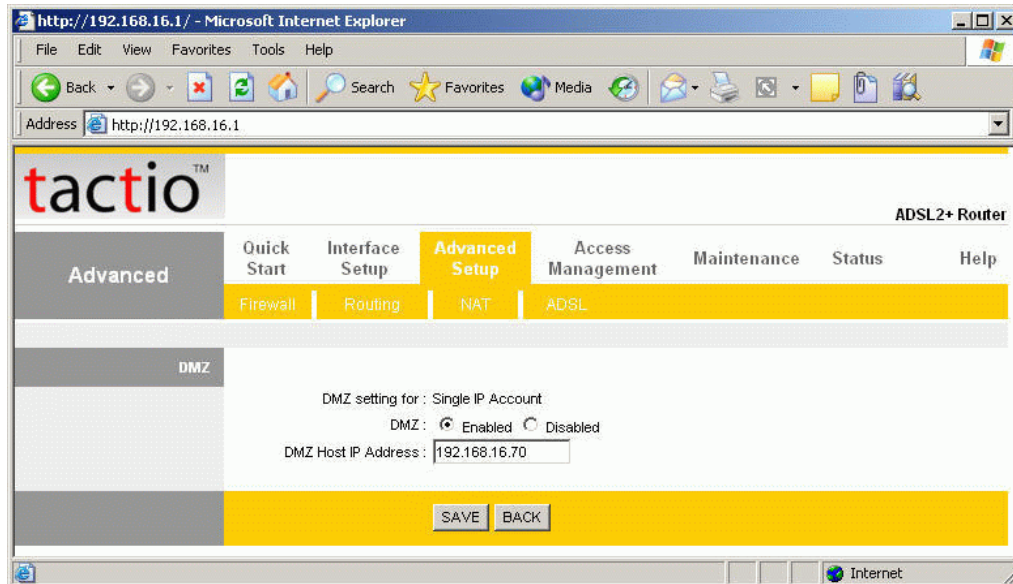

3.9.4 ADSL type Setting

Go to **Advanced Setup** -> **ADSL** to set different ADSL connection

If you meet a ADSL connection problem, you can select a different ADSL connection type to get more fast connection.

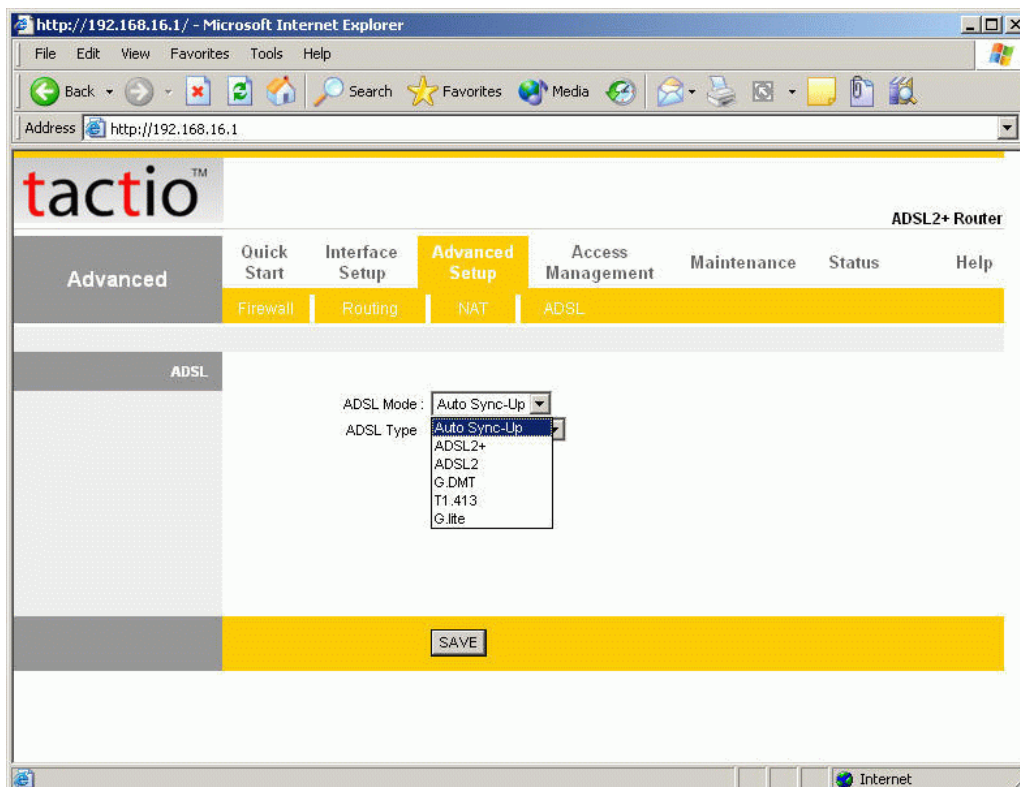

3.10.1 Static Routing

Go to **Advance Setup -> Routing ->Add** to setup static route features.

The static routing function determines the path that router follows over your network before and after it passes through your router. You can use static routing to allow different IP domain users to access the Internet through this device.

The screenshot shows a Microsoft Internet Explorer browser window displaying the Tactio ADSL2+ Router web interface. The address bar shows <http://192.168.16.1>. The interface has a navigation menu with tabs: **Advanced**, **Quick Start**, **Interface Setup**, **Advanced Setup** (selected), **Access Management**, **Maintenance**, **Status**, and **Help**. Under the **Advanced Setup** tab, there are sub-tabs: **Firewall**, **Routing** (selected), **NAT**, and **ADSL**. The **Static Route** configuration page is active, showing the following fields:

- Destination IP Address:
- IP Subnet Mask:
- Gateway IP Address:
- Metric:
- Announced in RIP:

At the bottom of the form, there are four buttons: **SAVE**, **DELETE**, **BACK**, and **CANCEL**.

3.10.2 Dynamic Routing

Go to **Interface Setup** -> **Internet** to select Dynamic Route as you need.

The dynamic routing feature of the router can be used to allow the router to automatically adjust to physical changes in the network's layout. The router uses the dynamic RIP protocol. It determines the route that the network packets take based on the fewest number of hops between the source and the destination. The RIP protocol regularly broadcasts routing information to other routers on the network.

The screenshot shows the Tactio ADSL2+ Router web interface in Microsoft Internet Explorer. The browser address bar shows `http://192.168.16.1/`. The page title is "tactio ADSL2+ Router". The navigation menu includes "Interface", "Quick Start", "Interface Setup", "Advanced Setup", "Access Management", "Maintenance", "Status", and "Help". Under "Interface Setup", there are sub-tabs for "Internet", "LAN", and "Wireless". The "Internet" tab is selected, and the "PPPoE/PPPoA" section is active. The "Connection Setting" section includes fields for Username (test), Password (masked), Encapsulation (PPPoE LLC), and Bridge Interface (Deactivated). The "IP Address" section includes fields for Static IP Address (0.0.0.0), IP Subnet Mask (0.0.0.0), Gateway (0.0.0.0), NAT (Enable), Default Route (Yes), TCP MTU Option (0 bytes), Dynamic Route (RIP2-B), Direction (Both), and Multicast (Disabled). A "SAVE" button is located at the bottom of the form.

3.10.3 Routing Table

Go to **Advance Management -> Routing** to see the Routing Table.

The Routing table allows you to see how many routings on your routing table and interface information

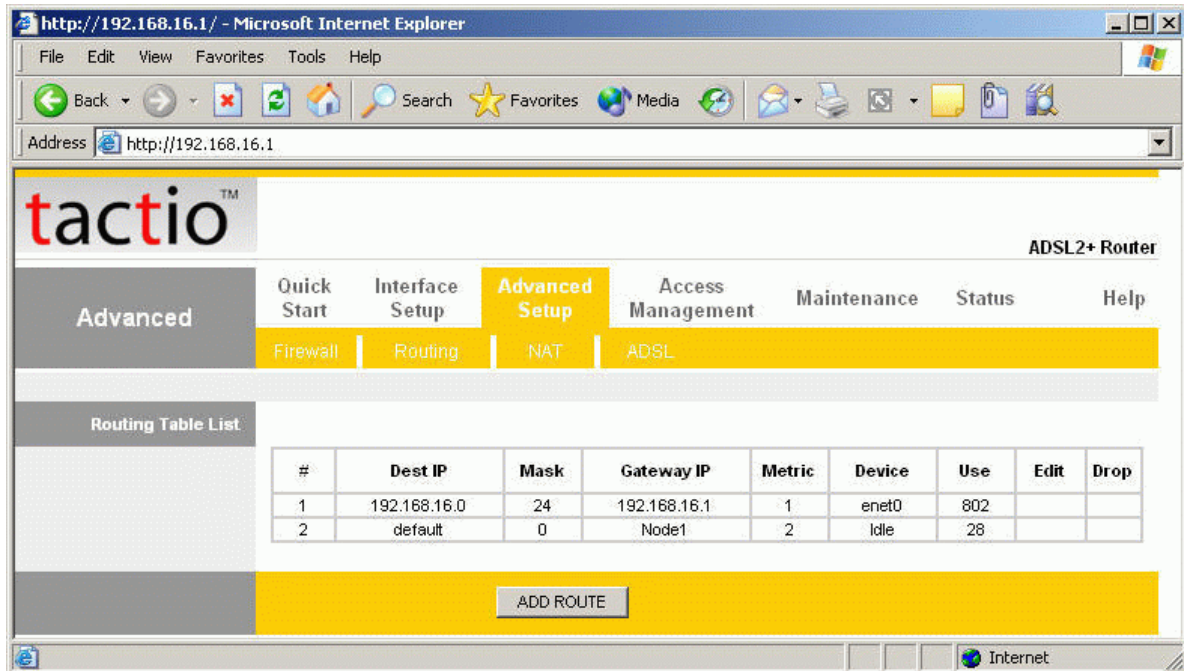

The screenshot shows the Tactio ADSL2+ Router web interface in Microsoft Internet Explorer. The browser address bar shows <http://192.168.16.1/>. The page title is "tactio™" and the device is identified as "ADSL2+ Router". The navigation menu includes "Advanced", "Quick Start", "Interface Setup", "Advanced Setup", "Access Management", "Maintenance", "Status", and "Help". Under "Advanced Setup", there are sub-menus for "Firewall", "Routing", "NAT", and "ADSL". The "Routing Table List" section displays a table with the following data:

#	Dest IP	Mask	Gateway IP	Metric	Device	Use	Edit	Drop
1	192.168.16.0	24	192.168.16.1	1	enet0	802		
2	default	0	Node1	2	Idle	28		

Below the table is a yellow "ADD ROUTE" button.

3.11.1 System Status

Go to **Status -> Device Info** to see the router's information. The System Status page shows the WAN, LAN and the router's firmware version.

http://192.168.16.1/ - Microsoft Internet Explorer

File Edit View Favorites Tools Help

Address http://192.168.16.1/

tactio™ ADSL2+ Router

Status Quick Start Interface Setup Advanced Setup Access Management Maintenance **Status** Help

Device Info System Log Statistics

Device Information

Firmware Version (0420) : 2.7.0.26(RUE0.B1)3.5.10.5
MAC Address : 00:05:b4:04:23:fc

LAN

IP Address : 192.168.16.1
Subnet Mask : 255.255.255.0
DHCP Server : Enabled

WAN

Virtual Circuit : PVC0
Status : Not Connected
Connection Type : PPPoE
IP Address : 0.0.0.0
Subnet Mask : 0.0.0.0
Default Gateway : 0.0.0.0
DNS Server : 0.0.0.0

ADSL

ADSL Firmware Ver : FwVer:3.5.10.5_A_TC3084 HwVer:T14.F7_0.0
Line State : Down
Modulation : Multi-Mode
Annex Mode : ANNEX_A

	Downstream	Upstream	
SNR Margin :	N/A	N/A	db
Line Attenuation :	N/A	N/A	db
Data Rate :	0	0	kbps

Internet

Appendix A Glossary

Address mask

A bit mask used to select bits from an Internet address for subnet addressing. The mask is 32 bits long and selects the network portion of the Internet address and one or more bits of the local portion. Sometimes called subnet mask.

AAL5

ATM Adaptation Layer - This layer maps higher layer user data into ATM cells, making the data suitable for transport through the ATM network.

ADSL

Asymmetric digital subscriber line

ATM

Asynchronous Transfer Mode - A cell-based data transfer technique in which channel demand determines packet allocation. ATM offers fast packet technology, real time, demand led switching for efficient use of network resources.

AWG

American Wire Gauge - The measurement of thickness of a wire

Bridge

A device connects two or more physical networks and forwards packets between them. Bridges can usually be made to filter packets, that is, to forward only certain traffic. Related devices are: repeaters which simply forward electrical signals from one cable to the other and full-fledged routers which make routing decisions based on several criteria.

Broadband

Characteristic of any network multiplexes independent network carriers onto a single cable. Broadband technology allows several networks to coexist on one single cable; traffic from one network does not interfere with traffic from another. Broadcast A packet delivery system where a copy of a given packet is given to all hosts attached to the network. Example: Ethernet.

CO

Central Office. Refers to equipment located at a Telco or service provider's office.

CPE

Customer Premises Equipment located in a user's premises

DHCP (Dynamic Host Configuration Protocol)

DHCP is software that automatically assigns IP addresses to client stations logging onto a TCP/IP network. DHCP eliminates having to manually assign permanent IP addresses to every device on your network. DHCP software typically runs in servers and is also found in network devices such as Routers.

DMT

Discrete Multi-Tone frequency signal modulation

Downstream rate

The line rate for return messages or data transfers from the network machine to the user's premises machine.

DSLAM

Digital Subscriber Line Access Multiplex

Dynamic IP Addresses

A dynamic IP address is an IP address that is automatically assigned to a client station (computer, printer, etc.) in a TCP/IP network. Dynamic IP addresses are typically assigned by a DHCP server,

which can be a computer on the network or another piece of hardware, such as the Router. A dynamic IP address may change every time your computer connects to the network.

Encapsulation

The technique used by layered protocols in which a layer adds header information to the protocol data unit (PDU) from the layer above. As an example, in Internet terminology, a packet would contain a header from the physical layer, followed by a header from the network layer (IP), followed by a header from the transport layer (TCP) and followed by the application protocol data.

Ethernet

One of the most common local area network (LAN) wiring schemes, Ethernet has a transmission rate of 10 Mbps.

FTP

File Transfer Protocol. The Internet protocol (and program) used to transfer files between hosts.

Hop count

A measure of distance between two points on the Internet. It is equivalent to the number of gateways that separate the source and destination.

HTML

Hypertext Markup Language - The page-coding language for the World Wide Web.

HTML browser

A browser used to traverse the Internet, such as Netscape or Microsoft Internet Explorer.

HTTP

Hypertext Transfer Protocol - The protocol used to carry world-wide-web (www) traffic between a www browser computer and the www server being accessed.

ICMP

Internet Control Message Protocol - The protocol used to handle errors and control messages at the IP layer. ICMP is actually part of the IP protocol.

Internet address

An IP address is assigned in blocks of numbers to user organizations accessing the Internet. These addresses are established by the United States Department of Defense's Network Information Center. Duplicate addresses can cause major problems on the network, but the NIC trusts organizations to use individual addresses responsibly. Each address is a 32-bit address in the form of x.x.x.x where x is an eight-bit number from 0 to 255. There are three classes: A, B and C, depending on how many computers on the site are likely to be connected.

Internet Protocol (IP)

The network layer protocol for the Internet protocol suite

IP address

The 32-bit address assigned to hosts that want to participate in a TCP/IP Internet.

ISP

Internet service provider - A company allows home and corporate users to connect to the Internet.

MAC

Media Access Control Layer - A sub-layer of the Data Link Layer (Layer 2) of the ISO OSI Model responsible for media control.

MIB

Management Information Base - A collection of objects can be accessed via a network management protocol, such as SNMP and CMIP (Common Management Information Protocol).

NAT

Network Address Translation - A proposal for IP address reuse, where the local IP address is mapped to a globally unique address.

NVT

Network Virtual Terminal

PAP

Password Authentication Protocol

PORT

The abstraction used by Internet transport protocols to distinguish among multiple simultaneous connections to a single destination host.

POTS

Plain Old Telephone Service - This is the term used to describe basic telephone service.

PPP

Point-to-Point-Protocol - The successor to SLIP, PPP provides router-to-router and host-to-network connections over both synchronous and asynchronous circuits.

PPPoE

PPP over Ethernet is a protocol for connecting remote hosts to the Internet over an always-on connection by simulating a dial-up connection.

Remote server

A network computer allows a user to log on to the network from a distant location.

RFC

Request for Comments - Refers to documents published by the Internet Engineering Task Force (IETF) proposing standard protocols and procedures for the Internet. RFCs can be found at www.ietf.org

Route

The path that network traffic takes from its source to its destination. The route a datagram may follow can include many gateways and many physical networks. In the Internet, each datagram is routed separately.

Router

A system responsible for making decisions about which of several paths network (or Internet) traffic will follow. To do this, it uses a routing protocol to gain information about the network and algorithms to choose the best route based on several criteria known as "routing metrics".

routing table

Information stored within a router that contains network path and status information. It is used to select the most appropriate route to forward information along.

Routing Information Protocol

Routers periodically exchange information with one another so that they can determine minimum distance paths between sources and destinations.

SNMP

Simple Network Management Protocol - The network management protocol of choice for TCP/IP-based Internet.

SOCKET

- (1) The Berkeley UNIX mechanism for creating a virtual connection between processes.
- (2) IBM term for software interfaces that allow two UNIX application programs to talk via TCP/IP protocols.

Spanning-Tree Bridge Protocol (STP)

Spanning-Tree Bridge Protocol (STP) - Part of an IEEE standard. A mechanism for detecting and preventing loops from occurring in a multi-bridged environment. When three or more LAN's segments are connected via bridges, a loop can occur. Because a bridge forwards all packets that are not recognized as being local, some packets can circulate for long periods of time, eventually degrading system performance. This algorithm ensures only one path connects any pair of stations, selecting one bridge as the 'root' bridge, with the highest priority one as identifier, from which all paths should radiate.

Spoofing

A method of fooling network end stations into believing that keep alive signals have come from and returned to the host. Polls are received and returned locally at either end

Static IP Addresses

A static IP address is an IP address permanently assigned to computer in a TCP/IP network. Static IP addresses are usually assigned to networked devices that are consistently accessed by multiple users, such as Server PCs, or printers. If you are using your Router to share your cable or DSL Internet connection, contact your ISP to see if they have assigned your home a static IP address. You will need that address during your Router's configuration.

Subnet

For routing purposes, IP networks can be divided into logical subnets by using a subnet mask. Values below those of the mask are valid addresses on the subnet.

TCP

Transmission Control Protocol - The major transport protocol in the Internet suite of protocols provides reliable, connection-oriented full-duplex streams.

TFTP

Trivial File Transfer Protocol - A simple file transfer protocol (a simplified version of FTP) that is often used to boot diskless workstations and other network devices such as routers over a network (typically a LAN).

Telnet

The virtual terminal protocol in the Internet suite of protocols - Allows users of one host to log into a remote host and act as normal terminal users of that host.

Transparent bridging

So named because the intelligence necessary to make relaying decisions exists in the bridge itself and is thus transparent to the communicating workstations. It involves frame forwarding, learning workstation addresses and ensuring no topology loops exist (in conjunction with the Spanning-Tree algorithm).

UDP

User Datagram Protocol - A connectionless transport protocol that runs on top of TCP/IP's IP. UDP, like TCP, uses IP for delivery; however, unlike TCP, UDP provides for exchange of datagrams without acknowledgments or guaranteed delivery. Best suited for small, independent requests, such as requesting a MIB value from an SNMP agent, in which first setting up a connection would take more time than sending the data.

UNI signaling

User Network Interface signaling for ATM communications.

Virtual Connection (VC)

A link that seems and behaves like a dedicated point-to-point line or a system that delivers packets in sequence, as happens on an actual point-to-point network. In reality, the data is delivered across a network via the most appropriate route. The sending and receiving devices do not have to be aware of the options and the route is chosen only when a message is sent. There is no pre-arrangement, so each virtual connection exists only for the duration of that one transmission.

WAN

Wide area network - A data communications network that spans any distance and is usually provided by a public carrier (such as a telephone company or service provider).

Appendix B Cabling / Connection

Network cables connect PCs in an Ethernet network Category 5, called "Cat5" for short is commonly used type of network cable today.

Cat 5 cables are tipped with RJ-45 connectors, which fit into RJ-45 port.

Straight-through vs. Crossover Cables:

Straight-through	
Wire	Becomes
1	1
2	2
3	3
6	6

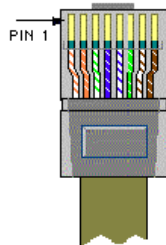

Crossover	
Wire	Becomes
1	3
2	6
3	1
6	2

LAN Connection:

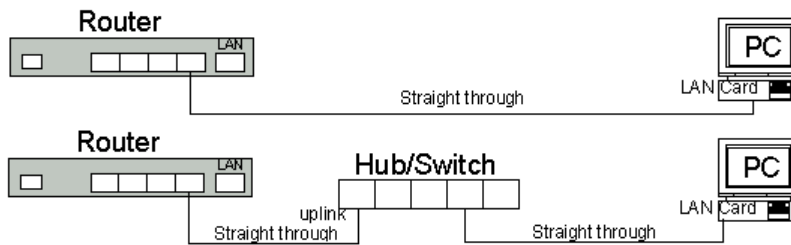

To check LEDs light up when you finish connecting two pieces of hardware.

Declaration of Conformity

The following
Equipment : ADSL2+ Wireless-G Router/ADSL2+ Router
Report No. : S940111

is herewith confirmed to comply with the requirements set out in the Council Directive on the harmonization of the Laws of the Member States relating to electrical equipment designed for use within certain voltage limits(73/23/EEC).

For the evaluation of above mentioned Directives, the following standards were applied:

EN 60950-1 : 2001

Testing Laboratory :

PEP TECHNOLOGIES LTD.
12FL-3, NO.27-1, LANE 169, KANG NING ST.,
HSI CHIH CITY, TAIPEI HSIEN, TAIWAN, R.O.C.

Declaration of Conformity

The following
Equipment : ADSL2+ Wireless-G Router/ADSL2+ Router
Report No. : E940644

is herewith confirmed to comply with the requirements set out in the Council Directive on the Approximation of the Laws of the Member States relating to Electromagnetic Compatibility(89/336/EEC) (1999/5/EC).

For the evaluation of above mentioned Directives, the following standards were applied:

ETSI EN 301 489-17 : V1.2.1 (2002-08)

Testing Laboratory :

PEP TECHNOLOGIES LTD.
12FL-3, NO.27-1, LANE 169, KANG NING ST.,
HSI CHIH CITY, TAIPEI HSIEN, TAIWAN, R.O.C.

Declaration of Conformity for CE Marking

The following
Equipment : ADSL2+ Wireless-G Router/ADSL2+ Router
Report No. : E940644

is herewith confirmed to comply with the requirements of its Harmonised Standards for CE Marking which have been set out in the Council Directive, and published as below:

- 1) The EMC Directives of 89/336/EEC, 92/31/EEC and 93/68/EEC;
- 2) The R&TTE Directive 1999/5/EC

For the evaluation of above mentioned Harmonised Standards, the following technical and test standards were applied:

ETSI EN 300328-1 : 2001

Testing Laboratory :

PEP TECHNOLOGIES LTD.
12FL-3, NO.27-1, LANE 169, KANG NING ST.,
HSI CHIH CITY, TAIPEI HSIEN, TAIWAN, R.O.C.

tactioTM

tactio corporation ltd.

www.tactio.net