

GE
Measurement & Control

Druck ADTS 505 Air Data Test Set

User Manual K0260

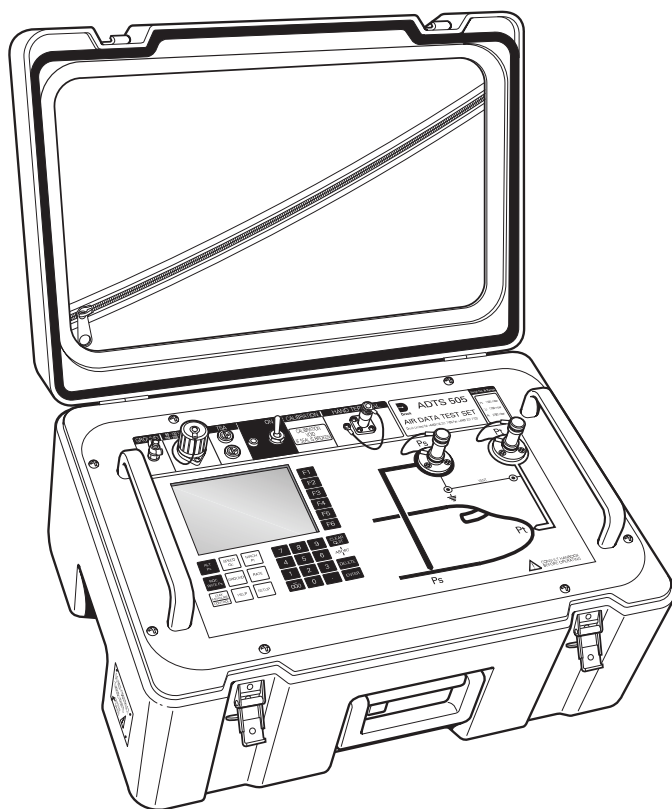

Introduction

- ◆ This technical manual provides operating instructions for the Air Data Test System compatible with the requirements of first line operation for the technician and supervisor.

Scope

- ◆ This technical manual contains a brief description, operation and testing procedures for the user of this equipment with software version V1.08.

Safety

- ◆ The manufacturer has designed this equipment to be safe when operated using the procedures detailed in this manual. Do not use this equipment for any other purpose than that stated, the protection provided by the equipment may be impaired.
- ◆ This publication contains operating and safety instructions that must be followed to make sure of safe operation and to maintain the equipment in a safe condition. The safety instructions are either warnings or cautions issued to protect the user and the equipment from injury or damage.
- ◆ Use qualified* technicians and good engineering practice for all procedures in this publication.

PIN Protection

The ADTS 505 contains two protected menus, the operating limits (described in this manual) and the maintain calibration menu (described in the calibration manual). The factory set PIN codes are contained in an envelope addressed to the Supervisor.

IMPORTANT NOTE

Change these codes for authorised access. Unauthorised access to these two menus can make this system inaccurate and could, in control mode, cause excessive rates of pressure change.

Pressure

- ◆ Do not apply pressure greater than the maximum safe working pressure to the equipment.

Toxic Materials

There are no known toxic materials used in this equipment.

Maintenance

- ◆ The equipment must be maintained using the manufacturer's procedures and should be carried out by authorized service agents or the manufacturer's service departments

Technical Advice

- ◆ For technical advice contact the manufacturer or subsidiary.

* *A qualified technician must have the necessary technical knowledge, documentation, special test equipment and tools to carry out the required work on this equipment.*

Associated Publications

This lists the manuals and publications referenced in this manual.

Calibration Manual K272

Air Data Test Set ADTS 505

Quick Reference Guide K274

Air Data Test Set ADTS 505

Approved Service Agents

Internet www.ge-mcs.com

Markings and Symbols



This equipment meets the requirements of all relevant European safety directives. The equipment carries the CE mark.



This symbol, on the instrument, indicates that the user should refer to the user manual. This symbol, in this manual, indicates a hazardous operation.



Do not dispose of this product as household waste. Use an approved organisation that collects and/or recycles waste electrical and electronic equipment. For more information, contact one of these:

- our customer service department (contact us at www.ge-mcs.com)
- your local government office

Approved Service Agents

For a list of approved service agents, visit our website: www.ge-mcs.com

Table of Contents

Preliminary pages		
Introduction		i
Scope		i
Associated Publication.....		ii
Approved Service Agents.....		ii
Table of contents (this table).....		iii
Abbreviations		vii
Glossary		ix
Pressure units and conversion factors.....		xi
Section	Title	page
1	DESCRIPTION	
1.1	Introduction.....	1-1
1.2	Operating Limits.....	1-3
2	INSTALLATION	
2.1	Packaging.....	2-1
2.2	Packaging for Storage and Transportation.....	2-1
2.3	Return Goods Procedure.....	2-3
2.4	Electrical Connection.....	2-6
2.5	Pneumatic Pressure Connection.....	2-7
2.6	Positioning of the ADTS 505.....	2-8
3	OPERATION	
3.1	Preparation.....	3-1
3.2	Display Functions and Units of Measure.....	3-2
3.3	Quick Reference.....	3-3
3.4	First Time Operators.....	3-4
	3.4.1..... Operating Modes.....	3-6
3.5	Operation and Example Procedures.....	3-10
	3.5.1..... Operating Procedures.....	3-10
	3.5.2..... Power-up.....	3-10
	3.5.3..... Control or Measure Parameter.....	3-11
	3.5.4..... Leak Testing the ADTS 505.....	3-11
	3.5.5..... Changing the Units of Measurement.....	3-13
	3.5.6..... Setting Limits.....	3-13
3.6	Tests Before Use.....	3-15
	3.6.1..... Aircraft System Protection.....	3-15
3.7	Testing Aircraft Systems or UUT.....	3-15
	3.7.1..... Testing the Aircraft Static System.....	3-16
	3.7.2..... Testing the Aircraft Pitot System.....	3-17
	3.7.3..... Combined Testing of the Aircraft Pitot and Static Systems.....	3-18
	3.7.4..... Mach Test and Constant Mach.....	3-19
	3.7.5..... Leak Testing.....	3-20
	3.7.6..... Airspeed Switch Test.....	3-21
	3.7.7..... Engine Pressure Ratio (EPR).....	3-22
	3.7.8..... Go To Ground.....	3-23

Table of Contents (contd)

Section	Title	page
3.8	Manual Venting of the Aircraft Pitot and Static Systems.....	3-24
3.9	ADTS 505 Options.....	3-24
3.10	Set-up Reference.....	3-25
4	MAINTENANCE	
4.1	Introduction.....	4-1
4.2	Materials and Tools.....	4-2
4.3	Maintenance Tasks.....	4-3
4.4	Routine Maintenance.....	4-4
5	TESTING AND FAULT FINDING	
5.1	Introduction.....	5-1
5.2	Standard Serviceability Test.....	5-2
5.3	Fault Diagnosis.....	5-3
5.4	Warnings and Self-test Errors.....	5-3
5.5	Further Testing.....	5-6
5.6	Fault Finding.....	5-14
6	REFERENCE and SPECIFICATION	
6.1	Introduction.....	6-1
6.2	Key-pad Selections and Functions.....	6-1
	F1 - F6.....	6-1
	ALT/Ps.....	6-2
	SPEED Qc.....	6-2
	MACH.....	6-3
	ROC Ps RATE.....	6-3
	RATE.....	6-4
	LEAK MEASURE/CONTROL.....	6-5
	GROUND.....	6-5
	0 to 9.....	6-6
	-000.....	6-6
	CLEAR/QUIT.....	6-6
	DELETE.....	6-6
	HELP.....	6-7
	ENTER.....	6-7
	CLEAR/QUIT + ENTER (ABORT).....	6-7
	Main Menu.....	6-8
	[Rate Timer].....	6-8
	[Units].....	6-9
	[EPR].....	6-10
	[Hold].....	6-10
	Nudge [▲ or ▼].....	6-10
6.3	SETUP.....	6-11
	6.3.1..... Set-up 1 of 2.....	6-11
 [Display],[Single, Dual, Quad, Hand Term].....	6-11

Table of Contents (contd)

Section	Title	page
	[Units]	6-12
	[Limits].....	6-13
	[Alt. Corr.].....	6-15
	[Date Format].....	6-16
	6.3.2 Set-up 2 of 2.....	6-17
 [Operational Hours].....	6-17
 [Software Versions].....	6-17
 [Security].....	6-17
 [Maintain Calibration].....	6-17
 [Auto Leak].....	6-18
6.4	Other Features.....	6-19
	Elapsed Time Counter.....	6-19
 Auto Zero.....	6-19
 Hand Terminal Option A.....	6-19
 Hand Terminal Option B.....	6-19
 Template Format for Creating Test Sequence Files.....	6-32
 Option B Advanced Hand Terminal Specification.....	6-41
6.5	Specification.....	6-42

Table of Illustrations

Figure	Title	page
1-1	ADTS 505 General View.....	1-2
2-1	ADTS 505 Accessories.....	2-4
2-2	ADTS 505 Altitude Correction On-aircraft.....	2-9
2-3	ADTS 505 Altitude Correction Off-aircraft.....	2-9
2-4	ADTS 505 General View.....	2-10
3-1	Key-pad and Display.....	3-3
4-1	Fuse Replacement.....	4-5
5-1	Fault Finding Chart.....	5-4
5-2	System Screen for Diagnosis.....	5-7
5-3	System Screen.....	5-9
5-4	Key-pad Test Display.....	5-10
6-1	ARINC 565 Limits Graph.....	6-14
6-2	Altitude Correction On-aircraft.....	6-15
6-3	Altitude Correction Off-aircraft.....	6-16
6-4	Interconnection.....	6-20
6-5	Power-up Displays.....	6-21
6-6	Main Menu Screen.....	6-22
6-7	Main Menu Structure.....	6-23
6-8	Manual Control Selections.....	6-24
6-9	Set-up Menu Selections.....	6-27
6-10	Test Sequence Selections.....	6-30
6-11	Customer Test Sequence File Selections.....	6-31
6-12	System Status.....	6-38
6-13	Example Error Screen.....	6-39

List of Tables

Table	Title	page
2-1	Parts List.....	2-5
4-1	Maintenance Chart.....	4-1
4-2	Materials List.....	4-2
4-3	Tool and Test Equipment Requirements.....	4-2
5-1	Fault Finding.....	5-5
5-2	System Screen Information.....	5-8
5-3	Error Messages.....	5-14
5-4	Warning Messages.....	5-15

Abbreviations

The following abbreviations are used in this manual; the abbreviations are the same in the singular and plural.

A	Ampere
abs	Absolute
a.c.	Alternating current
ADTS	Air Data Test Set
ALT	Altitude
ARINC	Air Radio Incorporated
ASI	Airspeed indicator
CAS	Calibrated airspeed
COSHH	Control of Substances Hazardous to Health Regulations
cm	Centimetre
d.c.	Direct current
Def	Define
e.g.	For example
EPR	Engine pressure ratio
etc.	And so on
°F	Degrees Fahrenheit
Fig.	Figure
ft	Foot
g	Gauge
h	Hour
HBC	High breaking capacity
Hg	Mercury
hm	Hecto metre
Hz	Hertz
IAS	Indicated airspeed
i.e.	That is
in	Inch
kg	Kilogram
km	Kilometre
kts	Knots
LCD	Liquid crystal display
m	Metre
mA	Milliampere
max	Maximum
mbar	Millibar
min	Minute or minimum
mm	Millimetre
mph	Miles per hour
MSDS	Material safety data sheet
mV	Millivolts
No.	Number
PIN	Personal identification number
Ps	Static pressure
psi	Pounds per square inch
Pt	Total pressure (Pitot)
Qc	Differential pressure Ps-Pt
QFE	Local atmospheric pressure
QNH	Barometric pressure at sea level

Abbreviations (contd)

RGA	Return Goods Authorization (Druck procedure)
RH	Relative humidity
RMS	Root mean square
ROC	Rate of climb
Rt	Rate
SST	Standard serviceability test
V	Volts
+ve	Positive
-ve	Negative
°C	Degrees Celsius
°F	Degrees Fahrenheit

Glossary

Terminology

The terminology used in this manual is specific and individual interpretation must not be introduced. The terms are defined as follows:

Adjust To bring to a more satisfactory state; to manipulate controls, levers, linkages, etc. to return equipment from an out-of-tolerance condition to an in-tolerance condition.

Align To bring into line; to line up; to bring into precise adjustment, correct relative position or coincidence.

Assemble: To fit and secure together the several parts of; to make or form by combining parts.

Calibrate: To determine accuracy, deviation or variation by special measurement or by comparison with a standard.

Check: Make a comparison of a measure of time, pressure, temperature, resistance, dimension or other quality with a known figure for that measurement.

Disconnect: To detach the connection between; to separate keyed or matched equipment parts.

Dismantle: To take apart to the level of the next smaller unit or down to all removable parts.

Examine: To perform a critical visual observation or check for specific conditions; to test the condition of.

Fit: Correctly attach one item to another.

Inspect: Review the work carried out by Specialists to ensure it has been performed satisfactorily.

Install: To perform operations necessary to properly fit an equipment unit into the next larger assembly or system.

Maintain: To hold or keep in any particular state or condition especially in a state of efficiency or validity.

Operate: Make sure that an item or system functions correctly as far as possible without the use of test equipment or reference to measurement.

Readjust: To adjust again; to move back to a specified condition; to bring back to an in-tolerance condition.

Reconnect: To rejoin or refasten that which has been separated.

Refit: Fit an item which has previously been removed.

- Remove: To perform operations necessary to take an equipment unit out of the next larger assembly or system. To take off or eliminate. To take or move away.
- Repair: To restore damaged, worn out or malfunctioning equipment to a serviceable, usable or operable condition.
- Replace: Remove an item and fit a new or a serviced item.
- Reset: To put back into a desired position, adjustment or condition.
- Service: To perform such operations as cleaning, lubricating and replenishing to prepare for use.
- Test: Ascertain by using the appropriate test equipment that a component or system functions correctly.

Table of pressure units and conversion factors

Pressure unit	Factor (Pascals)	Pressure unit	Factor (Pascals)
bar	100000	lbf/ft ²	47.8803
lbf/in ² (psi)	6894.76	inHg	3386.39
mH ₂ O	9806.65	inH ₂ O [1]	249.089
mbar	100	ftH ₂ O [1]	2989.07
kgf/cm ²	98066.5	atm	101325.0
kgf/m ²	9.80665	pdl/ft ²	1.48816
mmHg	133.322	dyn/cm ²	0.1
cmHg	1333.22	hbar	10000000
mHg	133322.0	tonf/ft ² (UK)	107252.0
mm/H ₂ O [1]	9.80665	tonf/in ² (UK)	15444300
cm/H ₂ O [1]	98.0665	inH ₂ O (USA) [2]	248.64135
N/m ²	1	ftH ₂ O (USA) [2]	2983.6983
hPa	100	kP/mm ²	9806650
kPa	1000	kP/cm ²	98066.5
MPa	1000000	kP/m ²	9.80665
torr	133.322		

Unit Conversion

To convert FROM pressure VALUE 1 in pressure UNITS 1

TO pressure VALUE 2 in pressure UNITS 2, calculate as follows:

$$\text{VALUE 2} = \text{VALUE 1} \times \frac{\text{FACTOR 1}}{\text{FACTOR 2}}$$

Note:

The conversion factor for pressure units referenced [1] are calculated for a water temperature of 4°C. Pressure units referenced [2] are calculated for a water temperature of 68°F these units are normally used in the USA.

1 INTRODUCTION

1.1 Introduction

- ◆ The ADTS 505 is a self-contained flight-line air data test system, enclosed in an ABS case. The unit provides complete pressure and vacuum measuring and control for on-aircraft sense and leak testing, functional tests of air data instruments, components and systems.
- ◆ The ADTS 505 displays and operates in either units of pressure measurement or aeronautical units. In the control mode, the rate that the pressures change towards new set-points can be controlled in true aeronautical rate units.
- ◆ There are two independent pneumatic channels connect to the aircraft or instrument systems, one for static and one for pitot. They can be operated as measure only channels with leak testing facilities or each can be control channels producing true pressure conditions for altitude and airspeed. Two pneumatic outlet ports, on the front panel and identified as Ps (static) and Pt (pitot) provide connection to the aircraft system or unit under test.
- ◆ To protect sensitive instruments and equipment a 'ground' facility automatically and safely controls both channels to atmospheric pressure at the previously entered rates of change and then informs the user when both channels are safely at 'ground'.
- ◆ Pre-defined sets of limits, stored in the system, prevent excessive pressures and rates damaging aircraft systems and components. A further five sets of operating limits can be defined by the supervisor or quality assurance engineer. The user can select sets of limits but cannot change the values.
- ◆ The user interface is either the key-pad and display on the front panel or one of two types of optional hand terminal connected to the front panel. The two types of hand terminal are identified as option A and option B.
- ◆ The option A hand terminal contains all the facilities of the front panel key-pad and display. The key-pad contains fixed function keys used to select various parameters, modes and enter numeric values. The display shows various menus, each menu provides selections using six menu-defined function keys.
- ◆ The option B advanced hand terminal is a computer-based device that contains all the facilities of option A on a touch-sensitive, Windows® display, colour screen. It also up-loads and down-loads user-defined test programs and displays the resulting test data.
- ◆ The integral pumps of the ADTS 505, produce pressure and vacuum supplies for the unit's controlling requirements. The power supply connection for the unit is located on the front panel.

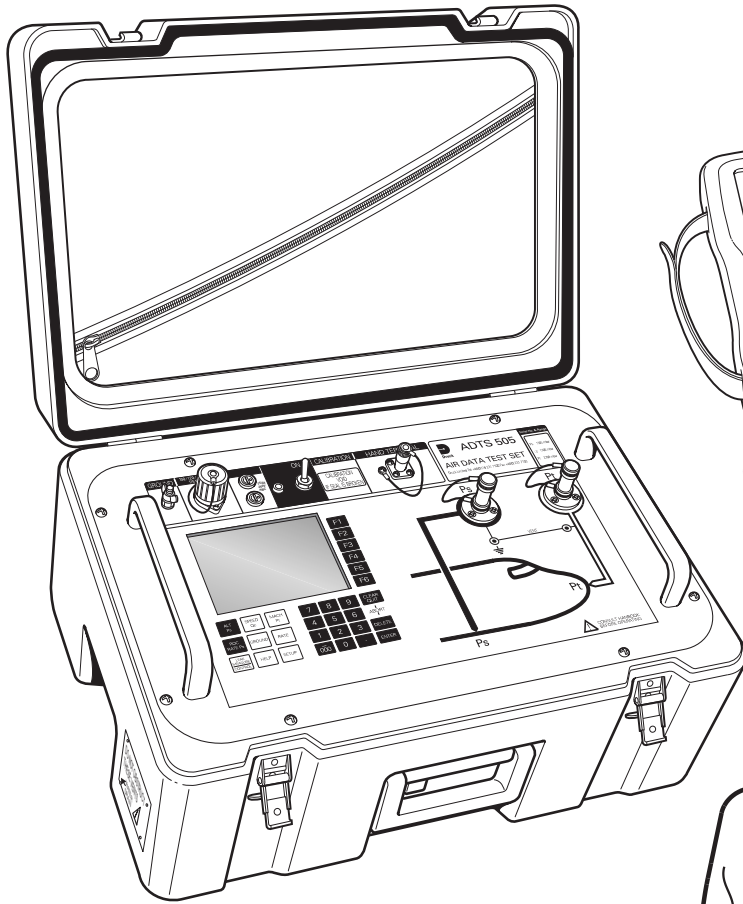

Option A Hand Terminal

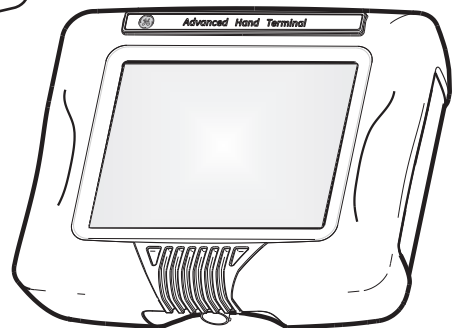

Option B Hand Terminal

FIGURE 1-1 ADTS 505 GENERAL VIEW

1.2 Operating Limits

The ADTS 505 is supplied with the following pre-defined operating limits.

Civil Limits

Parameter	Limit
MIN ALT	-1,000 ft
MAX ALT	50,000 ft
MIN CAS	0.0 knots
MAX CAS	450.0 knots
MAX MACH	1.000 Mach
MAX ROC	6,000 ft/min
ARINC LIMITS	OFF
ALT CORRECTION	0 ft
MIN Ps	115.972 mbar
MAX Ps	1050.406 mbar
MIN Qc	0.0 mbar
MAX Qc	368.01 mbar
MAX Rate Ps	109.85 mbar/min
MAX Rate Qc	109.85 mbar/min

Standard Limits

Parameter	Limit
MIN ALT	-2,000 ft
MAX ALT	60,000 ft
MIN CAS	0.0 knots
MAX CAS	650.0 knots
MAX MACH	1.732 Mach
MAX ROC	10,000 ft/min
ARINC LIMITS	OFF
ALT CORRECTION	0 ft
MIN Ps	65.00 mbar
MAX Ps	1088.6 mbar
MIN Qc	0.0 mbar
MAX Qc	866.00 mbar
MAX Rate Ps	200 mbar/min
MAX Rate Qc	200 mbar/min

Max Limits

Parameter	Limit
MIN ALT	-2,000 ft
MAX ALT	60,000 ft
MIN CAS	0.0 knots
MAX CAS	650.0 knots
MAX MACH	2.800 Mach
MAX ROC	40,000 ft/min
ARINC LIMITS	OFF
ALT CORRECTION	0 ft
MIN Ps	10.90 mbar
MAX Ps	1355.00 mbar
MIN Qc	-1355.00 mbar
MAX Qc	2490.00 mbar
MAX Rate Ps	1000 mbar/min
MAX Rate Qc	1000 mbar/min

EPR Limits

Parameter	Limit
MIN INLET	27.0 mbar
MAX INLET	1355.0 mbar
MIN OUTLET	27.0 mbar
MAX OUTLET	2500.0 mbar
MIN EPR	0.1
MAX EPR	10.0
MIN INLET RATE	0
MAX INLET RATE	1000 mbar/min
MIN EPR RATE	0
MAX EPR RATE	60 EPR/min

2 INSTALLATION

2.1 Packaging

On receipt of the ADTS 505 check the contents of the packaging against the following lists:

- i) ADTS 505 Air Data Test Set
- ii) Power supply cable - 5 m, no line plug (regional line plugs require option C)
- iii) Option A
 - comprising:
 - Hand terminal
 - Hand terminal cable - 18 m (option A only)
 - 5 m hose - red
 - 5 m hose - blue
 - Accessory Bag
- iv) Option B
 - comprising:
 - Advanced hand terminal
 - Hand terminal cable - 18 m (option B only)
 - Cable, communications
 - Cable, power supply
 - Power pack
 - Accessory Bag
- v) 3 m hose - red
- vi) 3 m hose - blue
- vii) User Manual (this publication)
- viii) Quick Reference Guide K0274
- ix) Kit, fuse/o-ring (also see Figure 2-1, item1)

2.2 Packaging for Storage or Transportation

To store the unit or to return the unit for calibration or repair carry out the following procedures:

1. Pack the unit as detailed in the following procedure.
2. To return the unit for calibration or repair complete the return goods procedure as detailed in 2.3.

Procedure

- ◆ The unit should be at zero/ambient pressure. Disconnect the hose assemblies and stow in the lid.
 - Switch OFF and disconnect from the electrical power supply. Disconnect the power supply cable and the hand terminal cable. Disconnect the hand terminal cable from the hand terminal.
 - Fit the lid to the unit.
 - The power supply cable, hand terminal cable and the hand terminal should be placed in the original packing material.
- ◆ If available, use the original packing material. When using packing materials other than the original, proceed as follows.
 - Wrap unit in polyethylene sheeting.
 - Select a double-wall cardboard container. Inside dimensions must be at least 15 cm greater than the equipment. The carton must meet test strength requirements of ≥ 125 kg.
 - Protect all sides with shock-absorbing material to prevent equipment movement within the container.
- ◆ Seal carton with approved sealing tape.
- ◆ Mark carton "FRAGILE" on all sides, top, and bottom of shipping container.
- ◆ To return the unit for calibration or repair complete the return goods procedure as detailed in 2.3.

Environment

- ◆ The following conditions apply for both shipping and storage:
 - Temperature Range..... -20 to +70°C (-4 to +158°F)
 - Altitude..... Up to 15,000 feet (4,570 metres)

2.3 Returned Goods Procedure

Should the unit require calibration or become unserviceable it can be returned to the Druck Service Department.

Please contact our Service Department, either by 'phone, fax or E-mail, to obtain a Returned Goods Authorization (RGA) number or (Return Material Authorization [RMA] in USA), providing the following information:

- Product (i.e. ADTS 505)
- Serial number
- Details of defect/work to be undertaken
- Calibration traceability requirements
- Operating conditions

Safety Precautions

You must also tell us if the product has been in contact with anything hazardous or toxic and, the relevant COSHH (MSDS in USA) references and precautions to be taken when handling.

IMPORTANT NOTICE

Service or calibration by unauthorized sources will affect the warranty and may not guarantee further performance

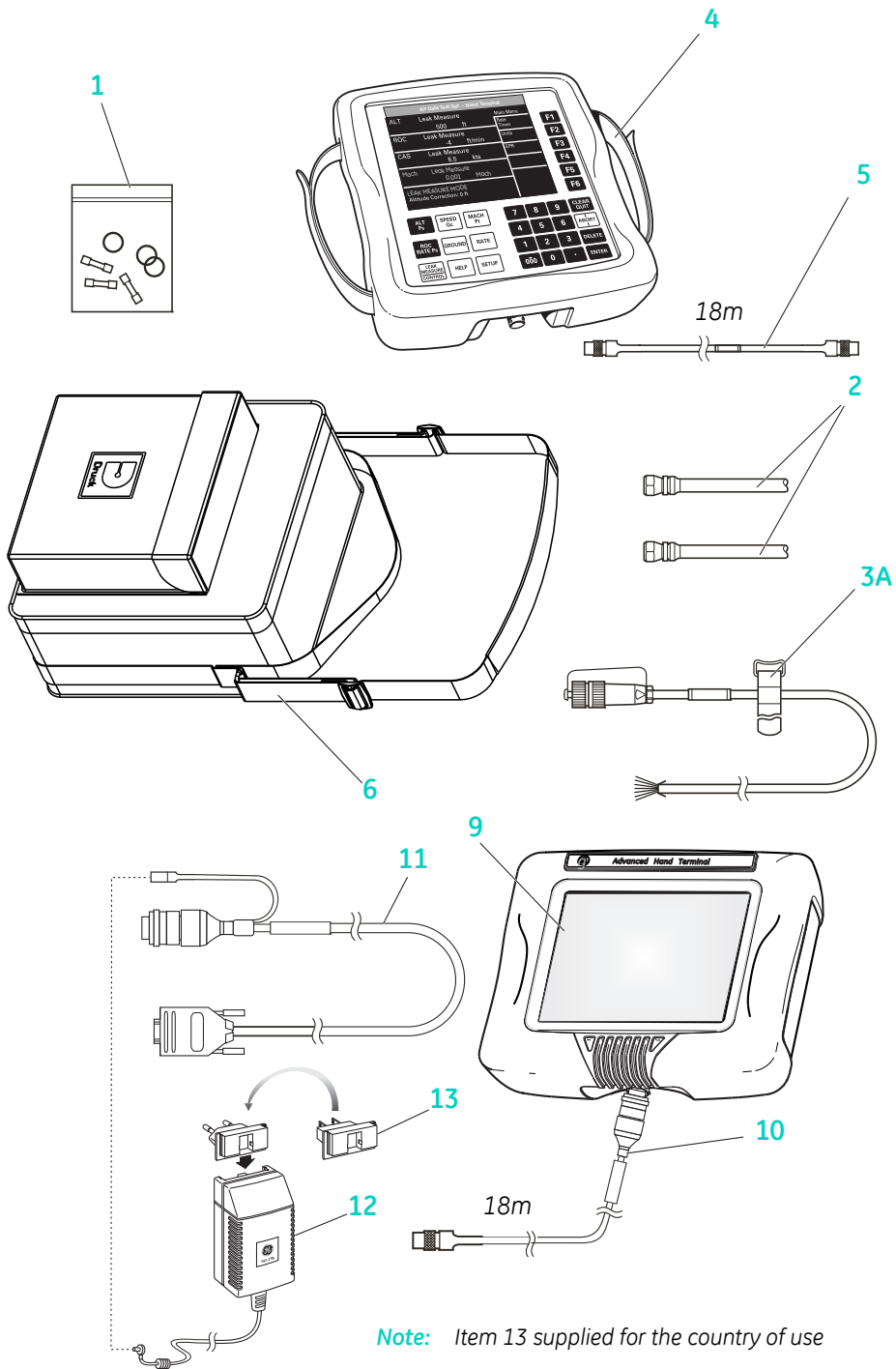

Note: Item 13 supplied for the country of use

FIGURE 2-1 ADTS 505 ACCESSORIES

No	Part Number	Description	Qty per assy
1	AS505-18-3124M0	Kit, fuse/o-ring comprising: o-ring AN4 fuse, T5.0A/250V HBC	1
2	AS505-53-3124M0	comprising: Hose, red, ST/OPN, AN4, 3m	1
		Hose, blue, ST/OPN, AN4, 3m	1
3A	AS505-40-3124M0	Cable, AC Power, 5M (open end)	1
3B#	AS505-40-3124M0	† Cable, AC Power, 5M (250V UK plug)	1
3C#	AS505-41-3124M0	† AC Power, 5M (115V US plug)	1
3D#	AS505-42-3124M0	† AC Power, 5M (250V European plug)	1
4	AS505-56-3124M0	Option A Hand terminal Assembly	1
4.1#	-	Option A and B Hose, red, 5M Hose, blue, 5M	1
5	AS505-54-3124M0	Option A Cable, Hand terminal 18M (option)	1
6	AS505-57-3124M0	Option A and B Bag, Accessory, Hand Terminal	1
7#	AS505-60-3124M0	Handbook, User Manual, K0260	1
8#	AS505-61-3124M0	Handbook, Calibration Manual, K0272	1
9	AS505-56-3124M1	Option B Hand terminal, Advanced	1
10	AS505-54-3124M1	Option B Cable, Hand terminal 18M, Safety marking (option)	1
11	AS204-06-3435M0	Cable, Communications PC	1
12	AS204-07-3435M0	Power pack	1
13	-	part of item 12 -Adaptor, power pack (comprising: 4)	1
14	AS204-10-3435M0	Stylus, pack (comprising: 3)	1

not illustrated † alternative

TABLE 2-1 PARTS LIST

2.4 Electrical Connection

WARNING: VOLTAGES IN EXCESS OF 30 VOLTS (RMS) AC OR 50 VOLTS DC, IN CERTAIN CIRCUMSTANCES, CAN BE LETHAL. CARE MUST BE TAKEN WHEN WORKING ON LIVE, EXPOSED CONDUCTORS.



Power Supply Connection

The unit must be connected to the correct electrical power supply as stated, adjacent to the power connector.

Open end cables

Only a qualified technician (see page i) must fit a connector to a cable supplied by GE (see Table 2-1, item 3).

CAUTIONS:

- 1 THE SUPPLY MUST PROVIDE CONNECTION TO A PROTECTIVE GROUND TERMINAL. THE UNIT MUST, AT ALL TIMES, BE CONNECTED TO THE SUPPLY EARTH (GROUND).
- 2 THE POWER SUPPLY CABLE AND CONNECTOR MUST BE CORRECTLY RATED FOR THE POWER SUPPLY.

Note: The ADTS 505 is normally supplied with an approved power supply cable for use in the country of delivery. This can limit the maximum supply voltage that can be safely used. e.g. a NEMA 5-15P terminated cable, for use in the U.S.A., is approved for a maximum of 125 V ac; it must be replaced for a higher supply voltage.

Pin (ADTS)	European Colour	U.S. Color	Function
1	Brown	Black	Live
4	Blue	White	Neutral
Centre	Green/Yellow	Green	Protective Earth (Ground)

- ◆ Make sure that the power supply is off before connecting the power cable.
- ◆ If required, connect the hand terminal to the connector on the front panel.

Note: Connecting the hand terminal to the unit disables the front panel key-pad.

Fuses

The two fuses, located in the holders and mounted on the front panel, protect the unit. The fuses are connected in the live and neutral supply circuit and are T5.0A/250V HBC type.

Note: Only replace the fuses with the correct type, see Figure 2-1 item1, to replace see section 4-5.

External earth/ground connection

- ◆ An external earth (ground) cable may be connected to the stud on the front panel of the unit providing integrity of the earth (ground) connection.

100 / 120 / 230V ~ 50 / 60Hz 200VA
115V ~ 400Hz 200VA

FIGURE 2-2 POWER SUPPLY LABEL

Connection

- The ADTS 505 provides a power supply to the advanced hand terminal when connected to the hand terminal connector on the front panel.
- The power supplies must be isolated when connecting the advanced hand terminal in the hazardous area.

Using the advanced hand terminal when not connected to the ADTS 505

Using the advanced hand terminal with a pc to create test scripts.

- The unit must be connected to the correct electrical power supply, see paragraph 2.4.
- Before use, make sure the SELV power adaptor supplied with the instrument is correct for the power supply voltage. The Safety Extra Low Voltage (SELV) power adaptor complies with EN61010 (including safety requirements for laboratory instruments).

Note: *The instrument can be powered from other DC power supplies of the correct voltage range. It is the user's responsibility to make sure the power supply is safe.*

- ◆ Make sure that the power supply is off before connecting the power cable.

Communications Connection

Communications cable - parts list item 11

Pin No. ADTS	Function	Connector	Cable Colour
1	0V	Jack plug outer	BLK
2	+ VIN	Jack plug inner	BLK-W
3	RS232 Tx	PIN 2	RED
4	RS232 Rx	PIN 3	GRN
5	RS232 0V	PIN 5	BLK

2.5 Pneumatic Pressure Connections

Ps (static)- AN4 (MS33656-4)

Pt (pitot)- AN4 (MS33656-4)

When not in use, a blanking cap must be fitted.

Note: *When carrying out a leak test, a leak of this blanking cap affects the performance of the ADTS 505.*

2.6 Positioning of the ADTS 505

WARNING: IN AN ENCLOSED AREA WITH FUEL VAPOUR PRESENT THIS EQUIPMENT MUST BE PLACED AT LEAST 0.5 METRES ABOVE FLOOR LEVEL. THIS EQUIPMENT CONTAINS A D.C. MOTOR WITH BRUSHES THAT COULD CAUSE A SPARK.



CAUTION: TO OPERATE, PLACE THE UNIT ON A HORIZONTAL SURFACE (FRONT PANEL UPPERMOST) OR VERTICALLY (POWER SUPPLY CONNECTOR UPPERMOST) THIS ALLOWS THE WATER IN THE WATER FILTER TO VENT. WATER COULD CONTAMINATE THE CONTROLLER MANIFOLD AND AFFECT CONTROLLER PERFORMANCE.

Note: In control mode, the water drain, located at one end of the unit near the carrying handle, produces a flow of air and some water. The amount of water depends on the humidity and the operating time in control mode.

CAUTION: BEFORE USE, CHECK THE WATER DRAIN PIPE, IT MUST BE FREE OF OBSTRUCTION. WHEN IN CONTROL MODE CHECK THAT A SMALL FLOW OF AIR COMES OUT OF THE DRAIN PIPE.

Notes:

- 1 When checking for a small flow of air do not block the drain pipe completely this causes a back-pressure in the pipe and controller instability.
- 2 If no air flows from the drain pipe, when in control mode, switch off and start again. If no air flows after a re-start, switch off and do not use the ADTS 505, return the unit to the repair depot.

CAUTION: THE SIDE VENTS MUST NOT BE OBSTRUCTED, THIS UNIT REQUIRES AN AIRFLOW FOR THE INTERNAL COOLING FANS.

- ◆ It is important that the position of the ADTS 505 in relation to the aircraft altitude sensors is known. An altitude correction must be made to allow for the difference in height between the reference level and the aircraft's altitude sensors (Figures 2-2 and 2-3). The Reference section contains details of altitude correction.

WARNING: OBSERVE THE APPROPRIATE SAFETY INSTRUCTIONS AND TESTING PROCEDURES DETAILED IN THE AIRCRAFT MAINTENANCE MANUALS AND COMPONENT MAINTENANCE MANUALS.



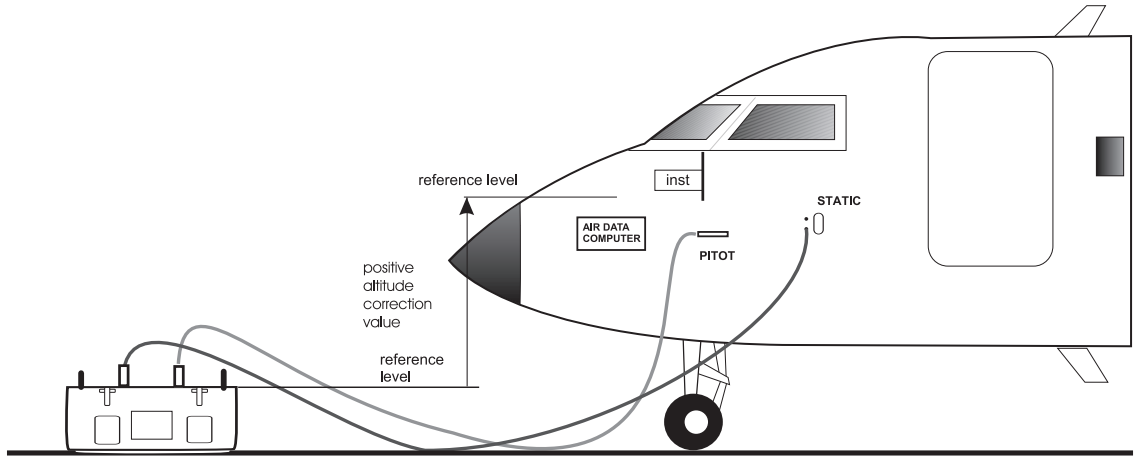

FIGURE 2-2 ADTS 505 ALTITUDE CORRECTION ON-AIRCRAFT

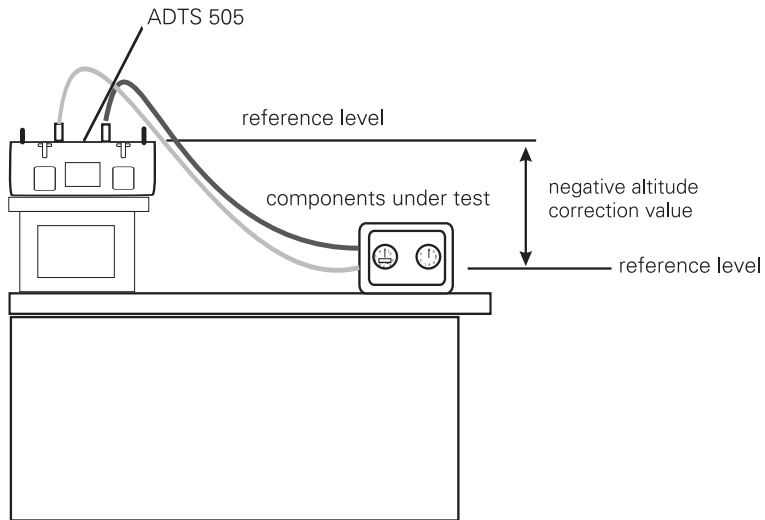

FIGURE 2-3 ALTITUDE CORRECTION OFF-AIRCRAFT

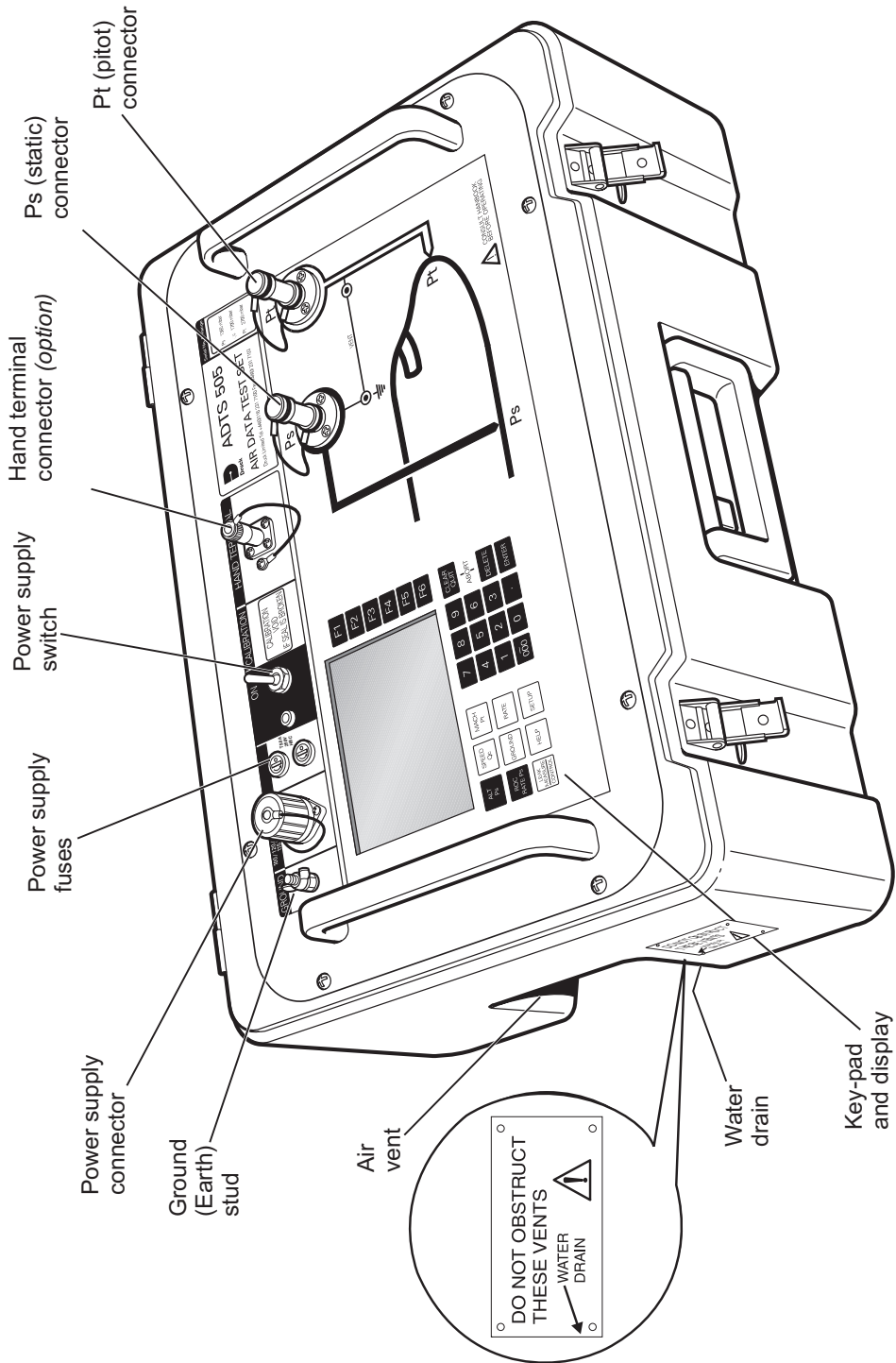

FIGURE 2-4 ADTS 505 GENERAL VIEW

3 OPERATION

3.1 Preparation

WARNING:

OBSERVE SAFETY PRECAUTIONS STATED IN LOCAL ORDERS AND THE AIRCRAFT OR EQUIPMENT SERVICING PROCEDURES.

- ◆ Make sure the electrical and pneumatic connectors, electrical cables and pipes and positioning of the ADTS 505 comply with the instructions and requirements in Section 2 Installation.
- ◆ Carry out the following before use:
 - ◆ If necessary, carry out the maintenance task detailed in Section 4.
 - ◆ Make sure the air data test system power supply switch on the front panel is set to OFF. Connect the air data test system to the electrical supply, make sure the supply includes a connection to a protective earth.
 - ◆ Inspect the pneumatic hoses for damage, ingress of dirt and moisture. Make sure the aircraft adaptors are serviceable and the pipe connections are air-tight.

Note: *Do not connect the air data test system to a contaminated aircraft system. Inspect the static vents and pitot probes for dirt and debris before connecting. If necessary, check the pitot-static system water drain traps.*

- ◆ Connect, to the air data test system, the hoses necessary for the test procedures to be carried out: STATIC output (Ps), PITOT output (Pt). Temporarily seal the free ends of the hoses.

Note: *When connected, take care not to kink or stand on the hoses.*

- ◆ Before use, the ADTS 505 should be tested, for first time users see section 3.4, for users requiring more operating detail see section 3.5.
- ◆ This section contains a quick reference chart detailing all the functions of the key-pad. Further quick reference charts, at the end of this section, detail the set-up menu.
- ◆ Review and become familiar with the whole procedure before starting the test process on an aircraft or component.

3.2 Display Functions and Units of Measure

When operating in either pressure measuring or pressure controlling modes, the ADTS 505 can display the following information:

<u>Aeronautical Functions</u>	<u>Display Abbreviation</u>	<u>Displayed Units</u> (if applicable)
Altitude	ALT	ft, m
Calibrated Airspeed	CAS	kts, km/h, mph
Mach	MACH	-
Rate of Climb	ROC	ft/min, m/min, m/s, hm/min
Rate of Airspeed	Rt CAS	kts/min, km/h/min, mph/min
<u>Pressure Functions</u>	<u>Display Abbreviation</u>	<u>Displayed Units</u> (if applicable)
Static (Absolute)	Ps	[P]
Pitot (Absolute)	Pt	[P]
Dynamic or Impact (Differential)	Qc	[P]
Engine Pressure Ratio	EPR	-
Rate of Ps	Rt Ps	[P] /min
Rate of Pt	Rt Pt	[P] /min
Rate of Qc	Rt Qc	[P] /min
Rate of EPR	Rt EPR	EPR/min

Where [P] is the currently selected pressure units from the following list:

mbar, inHg, mmHg, inH₂O (4°C), inH₂O (20°C), inH₂O (60°F), psi, hPa, kPa.

Operating Range and Performance

The ADTS 505 is supplied with a full-scale range of 650 knots for measurement and control of the pitot pressure channel. The unit can measure altitude up to 105,000 ft; altitude control depends on the performance of the pump, the integral pump is capable of achieving -2000 to 60,000 ft. Refer to section 6 for more details of performance and specification.

Sets of factory-defined limits known as ARINC565, Standard, Military, Max and EPR can be selected through the SETUP menu (see Reference section 6). Operators may also define up to five sets of additional limits for different aircraft types. When configuring the display to aeronautical or pressure units operators should be aware that when units of pressure are selected, wider full-scale pressure limits will be enabled for some parameters.

3.3 Quick Reference

KEY-PAD FUNCTION

the display shows the main pressure display (Leak Measure or Control mode) with normal operation key functions.

Key/selection

Function and comments

F1-F6

Function keys for menus

ALT/Ps

Altitude (Aeronautical units) or Ps (pressure units)

SPEED Qc

Airspeed (Aeronautical units) or Qc (pressure units)

EPR

Engine Pressure Ratio (pressure units only)

ROC/RATE Ps

Rate of Climb (Aeronautical units) or Rate of Ps (pressure units)

LEAK MEASURE/CONTROL

Switches between measure mode (for leak testing) and control mode

RATE

Rate of change of Pitot or Mach parameter, press parameter then RATE (read only)

GROUND

Controls Ps to atmospheric pressure and Qc to zero both at current rates of change

SETUP

Changes functions, limits and units, if [save/lock] pressed changes are permanent

HELP

Press HELP for further information on current selection/display

0-9

Number entry

-/000

Minus sign for first number entry 000 (thousand) if not first number of entry

CLEAR/QUIT

Clear number entry - quit from menu, HELP screen or clear warning message

ENTER

Complete number entry

DELETE

Removes the last number or character entered

CLEAR/QUIT + DELETE =

ABORT, all operations stop, the ADTS 505 restarts from a normal power-up sequence, including safe equalising of pressures between the test set and the connected system

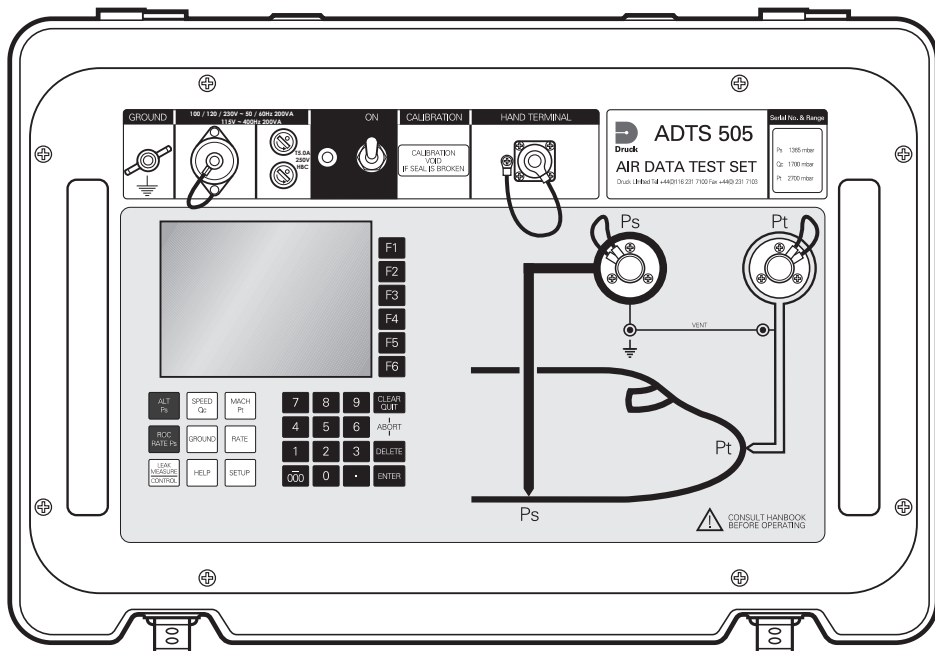
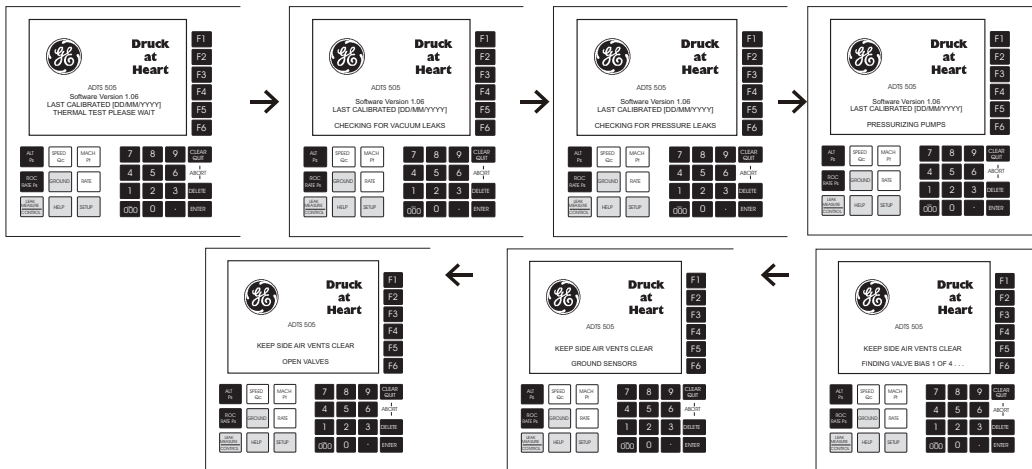
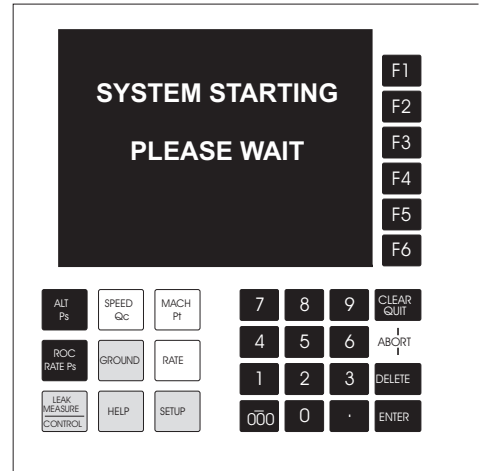

FIGURE 3-1 KEY-PAD AND DISPLAY

3.4 First Time Operators

◆ The following sequences of operation should be used by first time operators and by operators that use the equipment occasionally. For regular users, familiar with the equipment, go to section 3.5. Set the power supply switch to ON and the power-on routine starts.

- (1) The display first shows:
- (2) After approximately five seconds the display shows the start of the power-on sequence, the system carries out a self test. If the test finds a fault, the display shows an error message, refer to Section 5, Fault Finding and Testing.
- (3) The display messages show a sequence of pneumatic and internal system checks:



- (4) After a successful self-test sequence the system changes to measure mode. The display changes to the Leak Measure mode display showing the parameters selected in set-up.

(5) The system is now ready for use.

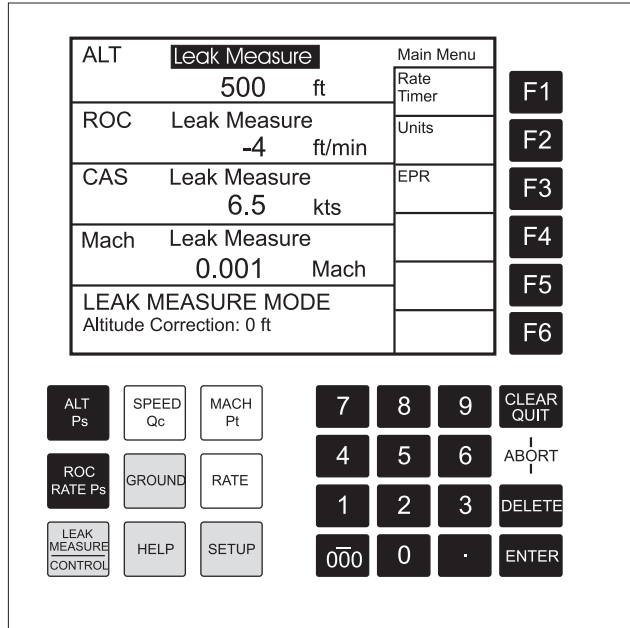

NOTES

- 1 The ADTS 505 is a continuous, self-monitoring system. If the system detects an error, the display shows an error message. Lists of errors are detailed in Section 5, Fault Finding and Testing.
- 2 The display at power-up will be [QUAD] format (see above) unless changed in **SETUP** and [Save Settings] selected.

(6) The connection of an optional hand terminal (option A or B) causes the front panel display to show one of two messages:

3

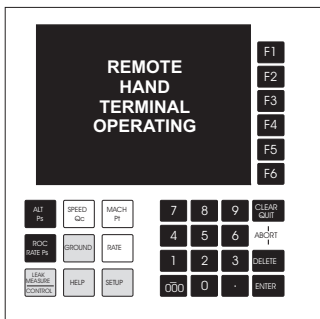

or

To change between these two displays, see **SETUP** and [Display], [Hand Term], [Monitor] or [Message]. See paragraphs 3.4.1 and 3.9.

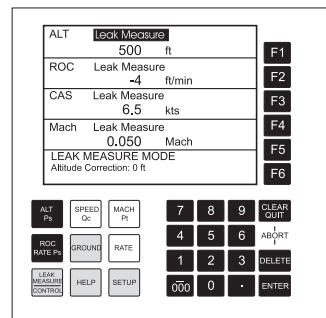

3.4.1 Operating Modes

The air data test system can now be set for a variety of functions and modes. In the following, examples of measure mode, control mode, leak measure mode and go-to-ground show the key presses and selections required for each mode.

Measure Mode

The system automatically enters measure mode after a successful self-test. To change the display press:

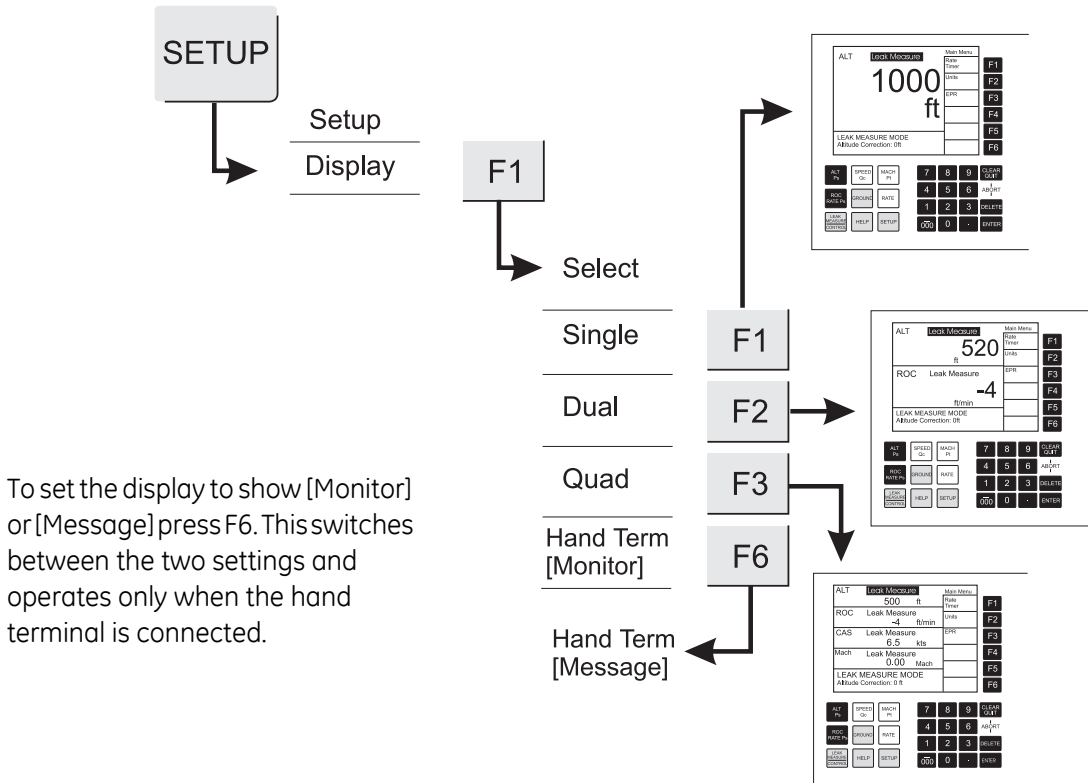

To store display for the next power-up press:

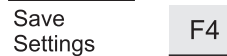

To return to measure mode press:



Checking the Limits

Before use on aircraft systems or components check that the limits are within the values stated in the appropriate maintenance manual. There are sets of factory-defined limits:

Civil, Standard, Max or EPR (refer to Section 1 for details)

At each power-up sequence the default set of limits "CIVIL" become active. The "CIVIL" limit set contains the lowest ranges and values. To see the name of the set of limits in use, press **SETUP** the display shows the [name] in the F3 limits field. To see the value of limits in use proceed as follows:

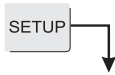

ALT	Leak Measure	463 ft	Setup	F1
ROC	Leak Measure	-2 ft/min	Display	F2
CAS	Leak Measure	420.0 kts	Units	F3
Mach	Leak Measure	0.350 Mach	Limits [CIVIL]	F4
LEAK MEASURE MODE			Altitude Correction	F5
Altitude Correction: 0 ft			Date Time	F6
			more (1 of 2)	

ALT Ps	SPEED Qc	MACH Pt	7	8	9	CLEAR QUIT
ROC RATE Ps	GROUND	RATE	4	5	6	ABORT
LEAK MEASURE CONTROL	HELP	SETUP	1	2	3	DELETE
			000	0	.	ENTER

Active Limit Set: CIVIL		Limits	F1
Available Preset Limits		▲	F2
MAX STANDARD		▼	F3
CIVIL		Select Limits	F4
Available User Limits		View Details	F5
USER 1		Enter PIN	F6
USER 2			
USER 3			
USER 4			
USER 5			

ALT Ps	SPEED Qc	MACH Pt	7	8	9	CLEAR QUIT
ROC RATE Ps	GROUND	RATE	4	5	6	ABORT
LEAK MEASURE CONTROL	HELP	SETUP	1	2	3	DELETE
			000	0	.	ENTER

The current selected limits can be viewed by pressing F3. To select and use one of the factory-defined limit sets or define one of five sets of user-defined limits, see 3.5.6. The selected set of limits remain active until the selection of another set of limits or until power supply switch-off.

Min ALT		-1000 ft	Details	F1
Max ALT		50,000 ft	Next Page	F2
Min CAS		0.0 knots		F3
Max CAS		450 knots		F4
Max Mach		1.0 Mach		F5
Max ROC		6,000 ft/min		F6
Alt Corr.		0 ft		
ARINC Limits		OFF		
Page #1				

ALT Ps	SPEED Qc	MACH Pt	7	8	9	CLEAR QUIT
ROC RATE Ps	GROUND	RATE	4	5	6	ABORT
LEAK MEASURE CONTROL	HELP	SETUP	1	2	3	DELETE
			000	0	.	ENTER

Details	
Next Page	
▲	
▼	
Modify Units	
ft kts	
ft/min	
more (1 of 2)	

Min Ps	115.97 mbar	Details	F1
Max Ps	1050.41 mbar	Next Page	F2
Min Qc	0.0 mbar		F3
Max Qc	368.01 mbar		F4
Rt Ps	100.00 mbar/min		F5
Rt Qc	100.0 mbar/min		F6
Page #2			

ALT Ps	SPEED Qc	MACH Pt	7	8	9	CLEAR QUIT
ROC RATE Ps	GROUND	RATE	4	5	6	ABORT
LEAK MEASURE CONTROL	HELP	SETUP	1	2	3	DELETE
			000	0	.	ENTER

Control Mode

When the system is in measure mode, to enter control mode press:

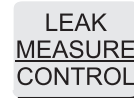

The display changes to:

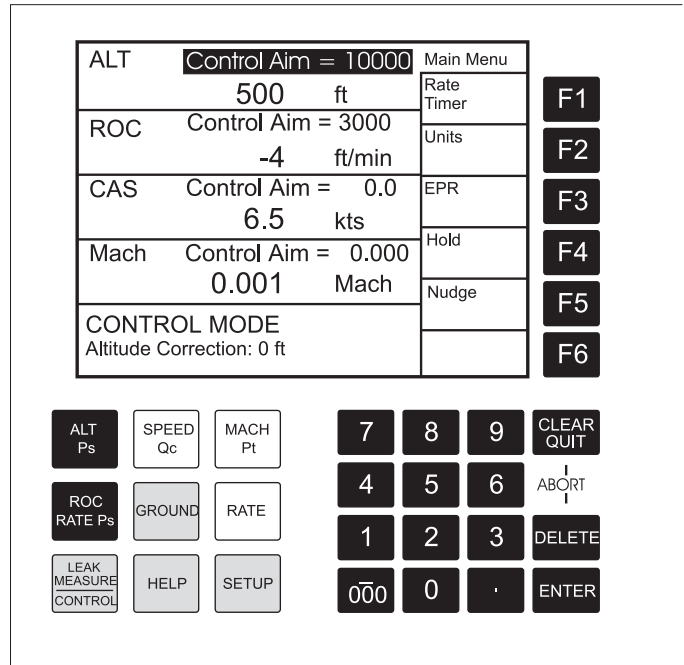

Note: The number of parameters displayed depends on the settings made in set-up, see previous page.

New set-point

To change the Aim value, press the required parameter key and, using the numeric keys, set the new Aim value. If necessary, use **DELETE** to remove the last digit set in the Aim value display field.

The display shows each numeric key press, a beep sounds with each key press. When the display shows the new Aim value press **ENTER**.

The display shows the parameter changing as the system controls to the set-point, at the set rate of change.

Go to GROUND

When the system is in control mode press:  →

Note: Go to ground does not operate in measure mode.

The ALT Aim value immediately changes to the current ground pressure (local airfield altitude) and the system safely controls to the GROUND value stored from power-up. The CAS Aim value immediately changes to zero and the system safely controls to zero:

The altitude and airspeed decreases at the rate set in ROC and RtCAS.

When the altitude and airspeed are at ground and zero the display changes to:

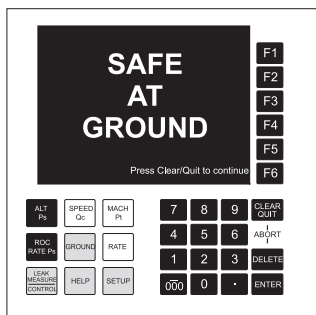
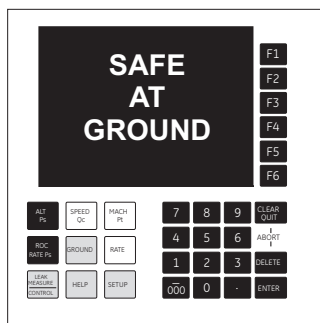
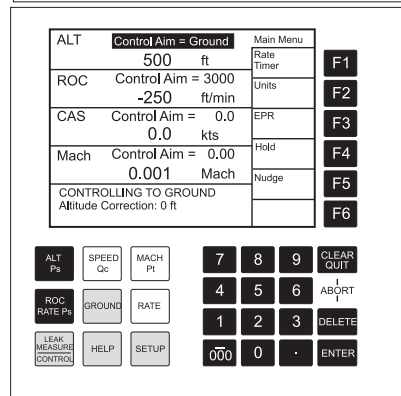
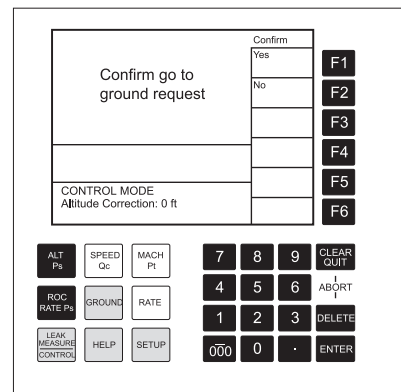

At ground and zero the display shows safe at ground for 5 seconds then the ADTS 505 system closes the output valves to isolate the aircraft system and goes into a system datum check routine (includes operation of the pump and control valves) go to 3.7.8 for more details.

After completion of the system datum check routine the display shows safe at ground and the message "Press Clear/Quit to continue".

It is now safe to continue testing or to switch off and disconnect the aircraft system.

When familiar with these procedures go to 3.5.4 to leak test the ADTS 505.

3.5 Operation and Example Procedures

3.5.1 Operating Procedures

- ◆ The procedures show the steps required to make sure the ADTS 505 is serviceable and the settings required to test an aircraft system or component. For further information refer to the Section 6 - Reference and Specification.

In the following:

- ◆ All key presses are highlighted in **bold** and shown as identified on the front panel.
- ◆ Key presses inside brackets e.g., [MORE], are soft key presses (i.e., function key selections {F1 to F6} indicated on the screen).

Help System

- ◆ The help information includes further details of the function and details associated functions, also see Section 6 - Reference and Specification.

3.5.2 Power-up

- ◆ Set the front panel power switch to ON and check the power indicator lights.
- ◆ The display shows the following sequence:
 - a. ADTS 505 power-up screen with the software version and the last calibration date.
 - b. Sequence of system and pneumatic tests:
 - i. Thermal test.
 - ii. Testing for vacuum leaks.
 - iii. Testing for pressure leaks.
 - iv. Pressurizing pumps.
 - v. Finding valve bias.
 - vi. Measuring ground pressure.
 - vii. Equalising system pressures.
 - c. Display shows Leak Measure mode and the number of parameters last selected in display set-up.
- ◆ Make sure that the ADTS 505 performs a self-test with no errors reported refer to Testing and Fault finding Section 5, for details of errors.
- ◆ The ADTS 505 always powers up in Leak Measure mode with the pressure controllers off. When changing to Control Mode the pump unit must be producing the correct pressure and vacuum.
- ◆ The ADTS 505 system is now ready for use. After approximately 15 minutes, the system may be used with full specification accuracy and stability.

3.5.3 Control or Measure Parameter

- ◆ To change the displayed Measure parameters:
Press **SETUP** [Displays], [Single, Dual, Quad], press **CLEAR/QUIT** repeatedly until the display goes to Leak Measure Mode.
 - ◆ Measure parameters:
 - Press the parameter key
 - e.g., press **SPEED/Qc** to display airspeed.
 - ◆ To change the displayed rate parameter:
 - Press the associated parameter key followed by the rate key.
 - e.g., display airspeed rate, press **SPEED/Qc** then **RATE**.
 - ROC/RATE Ps** may be directly pressed without first pressing **ALT/Ps**.
- ◆ In Leak Measure mode, pressing the parameter and rate keys changes the order that the display shows the parameters.

Control Aim

- ◆ A new control aim can be entered using the numeric keys. Each digit is displayed as it is pressed. The existing aim is replaced when the first digit of the new aim is pressed. If an error is made during the entry of data, press **CLEAR/QUIT** to restore the original aim.
- ◆ Press **ENTER** to action the new aim.

Note 1: The **-/000** key can be used as a quick way of entering thousands. If this key is pressed first (i.e. before a number is entered) the value becomes negative, press again the value becomes positive.

Note 2: The ADTS 505 must be in control mode to enter a new aim (current aim displayed). If the aim field shows "Leak Measure" press **LEAK MEASURE/CONTROL** to enter control mode.

3.5.4 Leak Testing the ADTS 505

- ◆ It is important to check that the ADTS 505 and the connecting hoses do not leak. Before use, a leak check should be carried out as follows:
 - ◆ Connect the Pitot and static hoses (to front panel of ADTS 505). Temporarily seal the free ends of the hoses.
 - ◆ Set the display to quad, see 3.4.1. Set the units to feet and knots, see 3.5.5.

- ◆ Press **LEAK MEASURE/CONTROL** to select Control mode.
- ◆ Using the set-up menu, choose the limits set for the aircraft or UUT, see 3.5.6.
 - ◆ Press **CLEAR/QUIT** repeatedly until the display shows control mode.
 - ◆ Set **ROC/RtPs** to 5000ft/min, enter an altitude aim of 1000 ft and an airspeed of 200 knots.
 - ◆ Wait until the system achieves the aim values and press **LEAK MEASURE/CONTROL** to change to Leak Measure mode.

Leak Measurement

Note: *Compressing a gas generates heat. Gas heated or cooled in an enclosed volume causes a pressure change. It is important, especially for leak testing, to allow enough time for the heated gas to cool and the pressure to stabilize.*

- ◆ In Leak Measure mode, select from the main menu [Rate Timer], and enter a wait time in minutes and seconds F3 - [Set Wait] 00m.30Secs. Enter a leak measure time in minutes and seconds F4 - [Set Time] 00m.30Secs. If necessary, press F5 to save these times for future use.
- ◆ Select [Start Timer] F1, as the rate timer starts, the display shows the count down (in seconds) of the wait time and then the count down of the timing. The status message at the bottom of the screen changes in this order LEAK MODE: WAIT: TIMING: RATES AVAILABLE: Wait until rate timer has completed, the rate parameters on the display changes from "Leak Measure" to "Timed Leak Measure" and shows the results in units/min.
 - Check ROC is less than ± 25 ft/min and Rt CAS is less than ± 0.25 kt/min.
 - Press CLEAR/QUIT to return to the main menu.
 - Press **LEAK MEASURE/CONTROL** to return to Control mode.
 - Press **GROUND**, to go to atmospheric pressure.
 - Wait until the display shows safe at ground (atmospheric pressure).
- ◆ After a successful leak test, the ADTS 505 is now ready to be connected to an aircraft system or unit under test.
- ◆ After an unsuccessful, first-time leak test, leave the system to achieve thermal stability for a further five minutes, press **CLEAR/QUIT** and repeat the leak test. If the leak test is now successful, the ADTS 505 is now ready to be connected to an aircraft system or unit under test.
- ◆ After another unsuccessful leak test, disconnect both hoses, check the condition of the o-rings on the Ps and Pt connectors as detailed in the maintenance section and firmly replace the blanking caps. Press **CLEAR/QUIT** and repeat the leak test procedure.
- ◆ After a successful leak test without hoses connected, replace or repair the faulty hose(s) and test again. If the ADTS 505 fails the leak test without hoses connected, switch off and return the unit to the repair depot.

3.5.5 Changing the Units of Measurement

- ◆ The units of measurement can be changed to units of pressure measurement or aeronautical units.
- ◆ To change the units:
 - Select, from the main menu, [Units].
 - Select from the Units Menu:
 - Select [Save Settings] to store as the units used at the next power up.
 - Press **CLEAR/QUIT** to return to the main pressure display.
 - In set-up, more units of pressure measurement can be selected for each parameter.

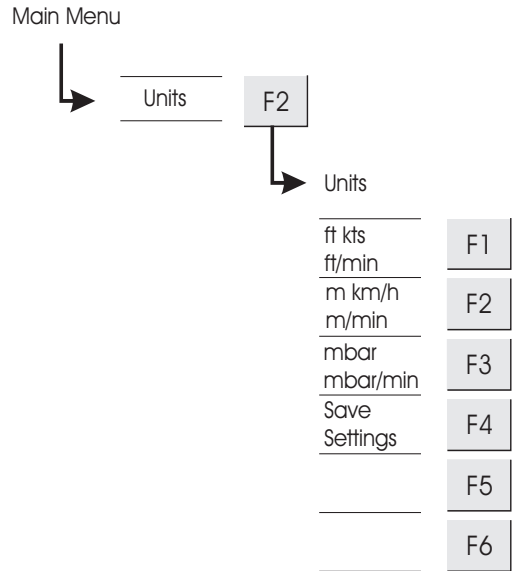

3.5.6 Setting Limits

- ◆ All data entered is checked against minimum and maximum values set for the particular limit set in use. If these limits are exceeded, the display shows a warning message "Changed aim to current limit". Press **CLEAR/QUIT** the system automatically modifies the aim values so that the limits are not exceeded. All limits of associated parameters are checked, if these limits are exceeded the display shows the warning message and the parameter modified. Similarly, if an ARINC 565 limit is exceeded when entering a value and, ARINC limits are enabled, the display shows a warning message. Refer to Section 6 for details of the factory-defined operating envelope ARINC565.
- ◆ In the SETUP function, previously stored sets of limits can be selected for use. Each set of limits is stored under name or number up to a maximum of 10 characters. To enable other sets of limits or enter additional sets of limits requires the supervisor PIN.

To select a limit set (User)

- ◆ Press SETUP, the display shows Setup, [Limits] [xxxxxx], where xxxxxx is the current name of the selected limit set. Select [Limits] [xxxx] F3.
- ◆ The display highlights the current set of limits in use by the name in the list. The current limit values can be inspected by pressing [View Details] F4. The display shows the current limit values and divides these values into aeronautical (Page #1) and pressure (Page #2).
- ◆ The ARINC 565 limit can be selected ON or OFF in a set of user defined limits, When selected, the values entered and/or achieved in control mode are checked within the operating envelope of the ARINC 565 limits, see section 6.
- ◆ To select another set of limits from the list press [Select Limits], F5. Use [▲] or [▼] to move through the list.

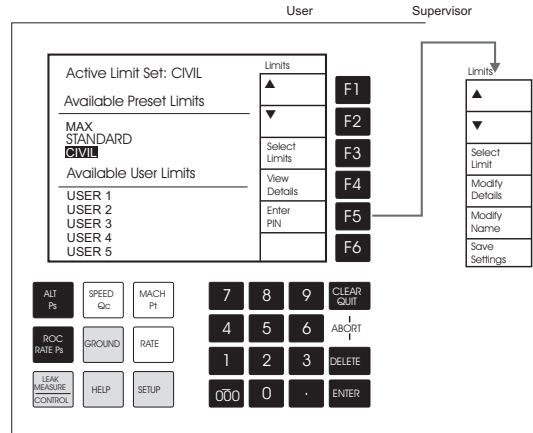

To edit a limit set (Supervisor)

- ◆ To edit or make a new set of limits press [Enter PIN], F3 and enter the PIN. Use [▲] or [▼] to move through the list. Each set of limits is identified by its name. New sets of limits can be created and existing sets of limits can be renamed or values changed. Refer to section 6 for more details. The user-named sets, can be edited by pressing [Select Limit {xxxxxx}], then Modify Details or Modify Name.
- ◆ Select [Save Settings] to store the new details or name to be used on the next power-up of the system.

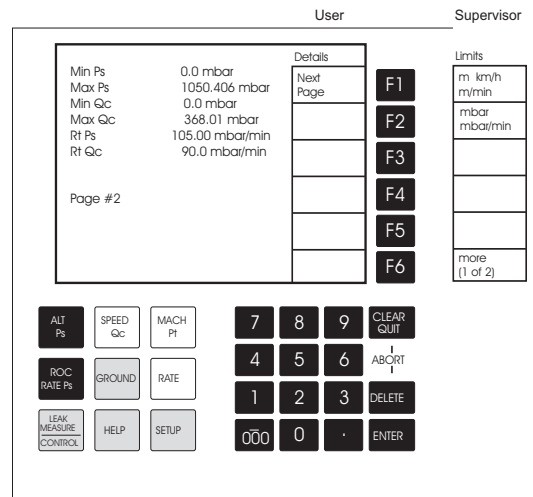
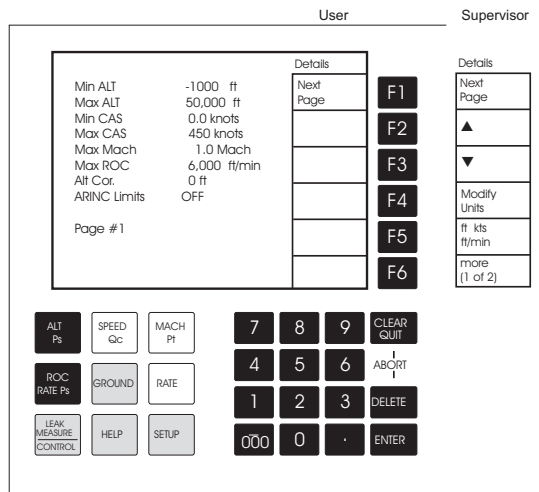

Notes:

- 1 For temporary changes press QUIT/CLEAR in place of [Save Settings].
- 2 The factory-defined limit sets, "STANDARD", "MAX" and "CIVIL" cannot be changed.

3.6 Tests Before Use

Note: *It is recommended that the following test is carried out, before use, at least once per day.*

1. Switch the unit ON. After the power-up routine, fit the blanking caps to the outlet ports.
2. Carry out the standard serviceability test in section 5.

Note: *It is recommended that, for protection, the blanking caps remain fitted to the outlet ports until required for connection to the Pitot-Static systems.*

3.6.1 Aircraft System Protection

- ◆ The ADTS 505 protects the aircraft system against user error and leaks in the aircraft system. The system protection operates:
 - ◆ Limit checking of all aim values entered.
 - ◆ Automatically regains control if the leak rate is greater than the parameter rate (RtPt, ROC) during leak testing.
- ◆ The pressure controllers within the ADTS 505 have the ability to feed a leak within an aircraft system. When first testing an aircraft system, carry out a leak test in accordance with the aircraft maintenance manuals.
- ◆ If, during a leak test, a leak in the system produces a rate of climb greater than ± 3000 ft/min or a rate of change of airspeed greater than ± 300 knots/min, then the pressure controllers automatically regain control to minimise damage to the aircraft system. This AUTO LEAK RECOVERY facility can be disabled.

3.7 Testing Aircraft Systems or UUT

WARNING:

OBSERVE THE APPROPRIATE SAFETY INSTRUCTIONS AND PROCEDURES DETAILED IN THE AIRCRAFT MAINTENANCE MANUALS OR COMPONENT MAINTENANCE MANUALS.

- ◆ Connect the hoses and appropriate adaptors to the aircraft system or UUT.
- ◆ To make sure that the connections to the aircraft system or UUT are not leaking carry out a leak test detailed in the appropriate aircraft or component manual.

3.7.1 Testing the Aircraft Static System

CAUTIONS:

- 1 **OBSERVE ALL SAFETY PRECAUTIONS DETAILED IN THE AIRCRAFT MAINTENANCE MANUAL.**
- 2 **WHEN USING Ps (STATIC ONLY), MAKE SURE THAT THE DIFFERENTIAL PRESSURE (Qc) STAYS WITHIN THE LIMITS OF THE ASI.**

1. Remove the static blanking cap and switch ON.
2. Connect the ADTS 505 to the Aircraft Static System.

Note: If the static system under test contains an ASI, applying static (vacuum) to this instrument generates a Q_c differential pressure.

3. Press **ALT/Ps** and make sure the display shows ALT Leak Measure.

Note: To monitor the rate of change press **ROC/RATE Ps** after pressing **ALT/Ps**. The control rate of change for altitude can be changed within the selected limits.

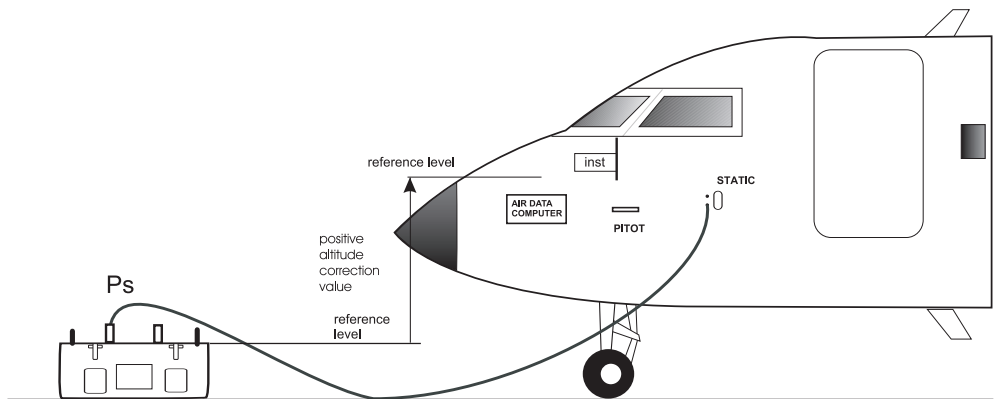

4. If necessary, select [Units] in the Main Menu, press F1 [ft, kts, ft/min]. Press **CLEAR/QUIT** to go back to the Main Menu.
5. If necessary change the limits in the Main Menu, press F6 [More], F1 [Limits]. After setting the limits, press repeatedly **CLEAR/QUIT** to go back to the Main Menu.
6. Press **LEAK MEASURE/CONTROL** to select control mode and, using the numeric keys, set the control aim. Press **ENTER**, the altitude changes to the control aim the rate of change slows as it gets near the control aim and does not "overshoot" the aim value.
7. Enter another aim or use the nudge facility to change the aim value. At the end of testing, press **GROUND** to return to atmospheric pressure.
8. On completion of testing, select **GROUND** and wait for the 'Safe at Ground' message to be displayed, see 3.7.8., refit the static blanking cap.

3.7.2 Testing the Aircraft Pitot System

CAUTIONS:

- 1 **OBSERVE ALL SAFETY PRECAUTIONS DETAILED IN THE AIRCRAFT MAINTENANCE MANUAL.**
- 2 **WHEN USING PT (PITOT ONLY), MAKE SURE THAT THE DIFFERENTIAL PRESSURE (Qc) STAYS WITHIN THE LIMITS OF THE ASI.**

1. Remove the Pitot and static blanking caps and switch ON.
2. Connect the ADTS 505 to the Aircraft Pitot System.
3. Press **SPEED/Qc** and make sure the display shows Qc Leak Measure.

Note: To monitor the rate of change press **RATE** after pressing **SPEED/Qc**. The control rate of change for airspeed is fixed at 300 kts/min.

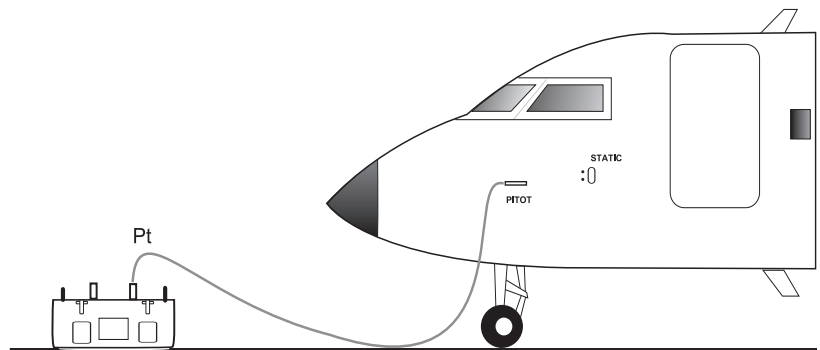

4. If necessary, select Units in the Main Menu, press F1 [ft, kts, ft/min]. Press **CLEAR/QUIT** to go back to the Main Menu.
5. If necessary change the limits in the Main Menu, press F6 [More], F1 [Limits]. After setting the limits, press repeatedly **CLEAR/QUIT** to go back to the Main Menu.
6. Press **LEAK MEASURE/CONTROL** to select control mode and, using the numeric keys, set the control aim. Press **ENTER**, the airspeed changes to the control aim the rate of change slows as it gets near the control aim and does not "overshoot" the aim value.
7. Enter another aim or use the nudge facility to change the aim value. At the end of testing, press **GROUND** to return to zero pressure.
8. On completion of testing, select **GROUND** and wait for the 'Safe at Ground' message to be displayed, see 3.7.8., refit the pitot and static blanking caps.

3.7.3 Combined Testing of the Aircraft Pitot and Static Systems

CAUTION:

OBSERVE ALL SAFETY PRECAUTIONS DETAILED IN THE AIRCRAFT MAINTENANCE MANUAL.

It is possible to combine the tests detailed in paragraphs 3.7.1 and 3.7.2. Any combination of altitude and airspeed can be established within the programmed set limits.

1. Remove the pitot and static blanking caps and switch ON.
2. Connect the ADTS 505 to the Aircraft Pitot and Static Systems.

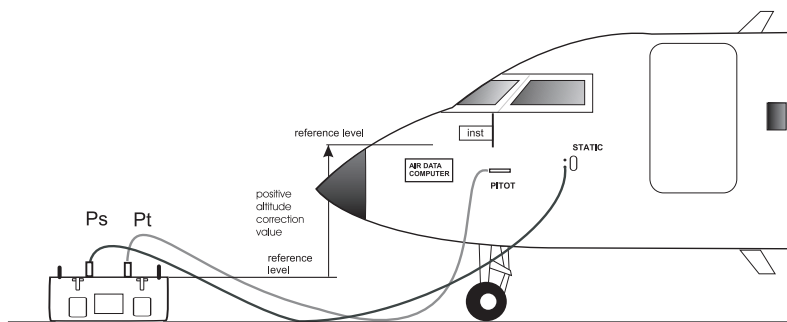

3. The most convenient way of observing speed and altitude is to change the display to Dual, showing both parameters. To observe rates of speed and altitude change the display to Quad and then, in turn press **ALT/Ps**, **ROC/RATE Ps**, **SPEED/Qc** and **Rate**; this will display the parameters in the most appropriate order.
4. If necessary, select [Units] in the Main Menu, press F1 [ft, kts, ft/min]. Press **CLEAR/QUIT** to go back to the Main Menu.
5. If necessary change the limits press **SETUP**, select F3 [Limits]. After setting the limits, press repeatedly **CLEAR/QUIT** to go back to the Main Menu.

Note: The control rate of change for altitude can be changed within the selected limits.

6. Press **LEAK MEASURE/CONTROL** and set the ALT Aim to the required pressure and then the **SPEED/Qc** CAS Aim to the required pressure.
7. Observe the display parameters changing as the ADTS 505 controls to the required altitude and airspeed.
8. On completion of testing, select **GROUND** and wait for the 'Safe at Ground' message to be displayed, see 3.7.8., refit the pitot and static blanking caps.

3.7.4 Mach Test and Constant Mach

Example

- ◆ To go to 0.45 Mach, proceed as follows:
 - Press **LEAK MEASURE/CONTROL** to enter Control Mode.
 - Press **SPEED/Qc** then **RATE** to display rate of change of airspeed.
 - The preset rate of speed is 300 kts/min.
 - Press **MACH/Pt.**
 - Enter an aim of 0.45.
 - Wait for the Mach aim to be achieved.
 - The system keeps the Mach aim constant by controlling/changing Pt (pitot) leaving Ps (static) at a constant value.

- ◆ On completion of testing, select **GROUND** and wait for the 'Safe at Ground' message to be displayed, see 3.7.8., refit the pitot and static blanking caps.

Notes

- 1 *If the altitude Ps (static) changes, the system automatically adjusts Pt (pitot) to keep the Mach value constant.*
- 2 *Use the nudge facility for small changes to the Mach aim value.*

3.7.5 Leak Testing

General

Apply pressure to the system under test as detailed in Testing the Aircraft Static or Pitot system. Before starting the leak test, check that the ADTS 505 is operating within range of the set limits.

Example

To leak test a pitot system to 300 knots at a maximum rate of 300 knots/min and a static system to 30,000 ft at a maximum rate 5,000 ft/min. Tests with a wait time of 5 minutes and test time of 1 minute. Maximum pitot system leak rate allowed 5 kts/min or less. Maximum static system leak rate 200 ft/min or less.

Procedure

1. Select F2 [Units], from the Main Menu, select F1 [ft, kts, kts/min]. Press **CLEAR/QUIT** to return to the main menu.
2. Press **SETUP**, select F1 [Display], press F3 [Quad] and then press **ALT/Ps, ROC/RATE Ps, SPEED/Qc** and **RATE** so that the display shows these parameters in the most appropriate order.
3. Press F3, [Rate Timer], then F3 [Set Wait 5.00], press **ENTER** and F4 [Set Time 1.00], press **ENTER**. Press F6 to return to the Main menu.
4. Press the **LEAK MEASURE/CONTROL** to enter control mode. Press **ROC/RATE Ps** and set an Aim of 5000 ft/min. Press **ALT/Ps** and set an Aim value of 30,000 ft and press **ENTER**. The system starts to control to the new set-point.
5. Press the **LEAK MEASURE/CONTROL** to enter measure mode. Press F1 [Rate Timer] and press F1 [Start Timing].
6. At the end of the timing check the rate of change (leak rate) this should be within the required limits stated in the Aircraft Maintenance Manual; in this example 200 ft/min or less.
7. Press the **LEAK MEASURE/CONTROL** to enter control mode. The preset rate of speed is set at 300 knots/min. Press **SPEED/Qc** and set an Aim of 300 knots. The system starts to control to the new set-point.
8. Press the **LEAK MEASURE/CONTROL** to enter measure mode. Press F1 [Rate Timer] and press F1 [Start Timing].
9. At the end of the timing check the rate of change (leak rate) this should be within the required limits stated in the Aircraft Maintenance Manual; in this example 5 kts/min or less.

Note: *If further testing is required, apply another pressure to the system under test and repeat the steps above.*

- ◆ On completion of testing, press the **LEAK MEASURE/CONTROL** to enter control mode, select **GROUND** and wait for the 'Safe at Ground' message to be displayed, see 3.7.8., refit the pitot and static blanking caps.

3.7.6 Airspeed Switch Test

◆ The following example shows how an airspeed switch can be functionally checked.

Note: For low airspeed switches (i.e. 130 knots) Pitot only could be used, 3.7.2.

- Press **LEAK MEASURE/CONTROL** to enter control mode. Press **SPEED/Qc**.
- Enter an Aim value below the operating limits of the switch (i.e., airspeed switch operating at 130 knots ± 2 knots set 127 knots).
- If necessary, press **RATE** and enter a change of airspeed low enough to observe switch operation.
- Press **ENTER** and observe the airspeed changing.
- Using the NUDGE facility, to step-increase, at a fixed increment (0.2 knots), the Aim value.
- Increase the Aim until the switch operates (contacts close) and record the value.
- Change the Aim to above the airspeed operating range (i.e. 133 knots). Repeat the steps, decreasing the Aim value until the airspeed switch operates (contacts open) and record value.
- On completion of testing, select **GROUND** and wait for the 'Safe at Ground' message to be displayed, see 3.7.8., refit the pitot and static blanking caps.
- This procedure can be repeated.
- The above method can be used for the other parameters:

Examples:

- | | | |
|------------------------|---|---|
| <i>Altitude switch</i> | - | <i>low altitude warning</i> |
| | - | <i>landing gear configuration warning</i> |
| | - | <i>height lock</i> |
| <i>Mach switch</i> | - | <i>Speed brake scheduling</i> |
| | - | <i>Mach cruise lock</i> |

3.7.7 Engine Pressure Ratio

- ◆ The ADTS 505 may be used to check EPR sensors and indicators. Use Ps (static) for INLET pressure and Pt (Pitot) for OUTLET pressure.
- ◆ To carry out an EPR check, the display must be showing units of pressure measurement e.g., mbar, inHg, psi.

Note: *Altitude correction applies to EPR values make sure this correction does not adversely affect accuracy. The difference in height between the ADTS 505 and the EPR sensor may be different to the altitude correction previously set for the aircraft instruments.*

- ◆ To change units:
 - Press F2 [Units].
 - Select required pressure units, the pressure units are selected in set-up.
 - Use **CLEAR/QUIT** to return to pressure display.
- ◆ To enter an EPR of 1.8 with inlet pressure of 500 mbar (15 inHg), proceed as follows:
 - If the display shows "Leak Measure", press **LEAK MEASURE/CONTROL** to go to control.
 - Press [Rate Inlet], F2 and set 200mbar/min.
 - Press [Rate EPR], F4 and set 0.8 EPR/min.
 - Press [Inlet], F1 set an aim value of 500 mbar (15 inHg).
 - Select [EPR] F3, set an aim value of 1.8.
 - Wait for the controller to achieve the EPR aim value. Press [Outlet], F5 to confirm 900 mbar.

Note: *EPR testing can also be performed by specifying the actual INLET and OUTLET values. In the above example, with inlet at 500 mbar, a ratio of 1.8, the outlet value should be $500 \text{ mbar} \times 1.8 = 900 \text{ mbar (Pt)}$ [$15 \text{ inHg} \times 1.8 = 27 \text{ inHg (Pt)}$].*

- ◆ Some EPR procedures (earlier ECU) may require measurement in aeronautical units:
 - Set to aeronautical units, press **LEAK MEASURE/CONTROL** and set the inlet pressure (ALT control aim) to the required value.
 - Change units to pressure, press EPR, set the required ratio.
 - Allow the system to achieve the control aim. Exit EPR and return to leak measure mode. Change units to aeronautical and record the resulting value in knots.
- ◆ On completion of EPR testing, select **GROUND** and wait for the 'Safe at Ground' message to be displayed, see 3.7.8., refit the pitot and static blanking caps.

3.7.8 Go To Ground

◆ On completion of testing and, before disconnecting from the aircraft system or UUT, the pressures in the system must be taken to the local atmospheric pressure (ground) with zero airspeed.

- If the display shows "Leak Measure", press **LEAK MEASURE/CONTROL**.
- Press **GROUND**, (go to ground).
- The pressure in the system changes towards ground. The ground pressure replaces the static or altitude aim value; zero replaces the airspeed aim.

Note: *If required, new rates of change can be entered while going to ground.*

- Wait for the display to show zero airspeed and atmospheric pressure.
- The display changes to "safe at ground" for 5 seconds then to "aircraft safe at ground" with the message "confirming system settings".

Note: *During this operation:*

keep the power supply connected and switched on.

the system disables the key-pad.

it is safe to disconnect the pipes from the aircraft system or UUT.

- After completing this operation the display changes back to "safe at ground" with the message "Press Clear/Quit to continue".
- It is now safe to continue testing or to switch off and disconnect the aircraft system or UUT.

Note: *If the ADTS 505 stays in the "safe at ground" for 30 minutes the "confirming system settings" operation will be repeated. The operation automatically re-checks the ADTS controller settings, the pumps start and the display shows:*

No pressure is applied to the output ports during this operation.

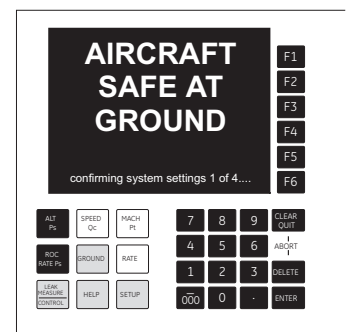

Shut-down

- When the airspeed is zero and the Ps channel pressure is close to ground, the atmospheric pressure is re-measured to update the recorded ground pressure (QFE).
- Press **QUIT/CLEAR** to continue with normal operation; the ground and zero valves automatically close.

3.8 Manual Venting of the Aircraft Pitot and Static Systems

- ◆ This procedure should be carried out when the power supply has failed and the ADTS 505 has failed-safe with pressures remaining in the aircraft system. The aircraft system pressures must be slowly changed to atmospheric pressure in the following way:

CAUTION:

- 1 **THE AIRCRAFT INSTRUMENTS MUST BE MONITORED THROUGHOUT MANUAL VENTING. DO NOT EXCEED THE MAXIMUM RATES OF CHANGE OF PRESSURES FOR THE INSTRUMENTS IN THE AIRCRAFT SYSTEM. REFER TO THE AIRCRAFT MAINTENANCE MANUAL.**
- 2 **FOLLOW THIS PROCEDURE; DO NOT PRODUCE A NEGATIVE AIRSPEED THIS WILL DAMAGE AIRCRAFT INSTRUMENTS.**
 - i. Using a screwdriver, carefully open the Qc manual vent and allow the pressure in the pitot (Pt) and static (Ps) systems to equalise (shown on the aircraft ASI). Fully open the Qc valve.
 - ii. Using a screwdriver, carefully open the Ps manual vent do not exceed a rate of 3000 ft/min.
 - iii. When the indicated pressures, shown on the aircraft instruments, reaches atmospheric pressure close both vents.

3.9 ADTS 505 Options

Hand Terminal Option A

- ◆ The hand terminal provides the same selections and displays as the front panel display. When connected the system auto-detects the hand terminal and disables the front panel key-pad. The front panel display shows "Remote Hand Terminal Operating" (message/monitor) or the current values and modes of the hand terminal (monitor). The display menu in set-up provides the selection between message and monitor.

Advanced Hand Terminal Option B

CAUTION:

ONLY USE THIS ADVANCED HAND TERMINAL WITH ADTS 505 UNITS AT MODIFICATION STATE 3, DAMAGE WILL OCCUR TO ADTS 505 UNITS AT EARLIER MODIFICATION STATES.

- During the early power-up, self-test period, the instrument display screen shows:

"Software Version 1.07+"

This text is located just above the last calibration date entry.

- ◆ The advanced hand terminal provides a Windows®-based, touch-sensitive colour screen to upload and download user-defined test programs. When connected, the system auto-detects the advanced hand terminal and disables the front panel key-pad. The front panel display shows "Remote Hand Terminal Operating" (message/monitor) or the current values and modes of the advanced hand terminal (monitor). At power-up, the display shows the main operation menu with selections for system set-up, test sequence files and manual control. See 6.4 for the details and procedures for the advanced hand terminal.
- ◆ *If the ADTS 505 unit is not at the correct modification state, contact the local GE Sensing sales team to arrange for a free upgrade of your unit.*

www.ge-mcs.com

3.10 Set-up Reference

The following charts provide a user reference for the set-up functions of the ADTS 505.

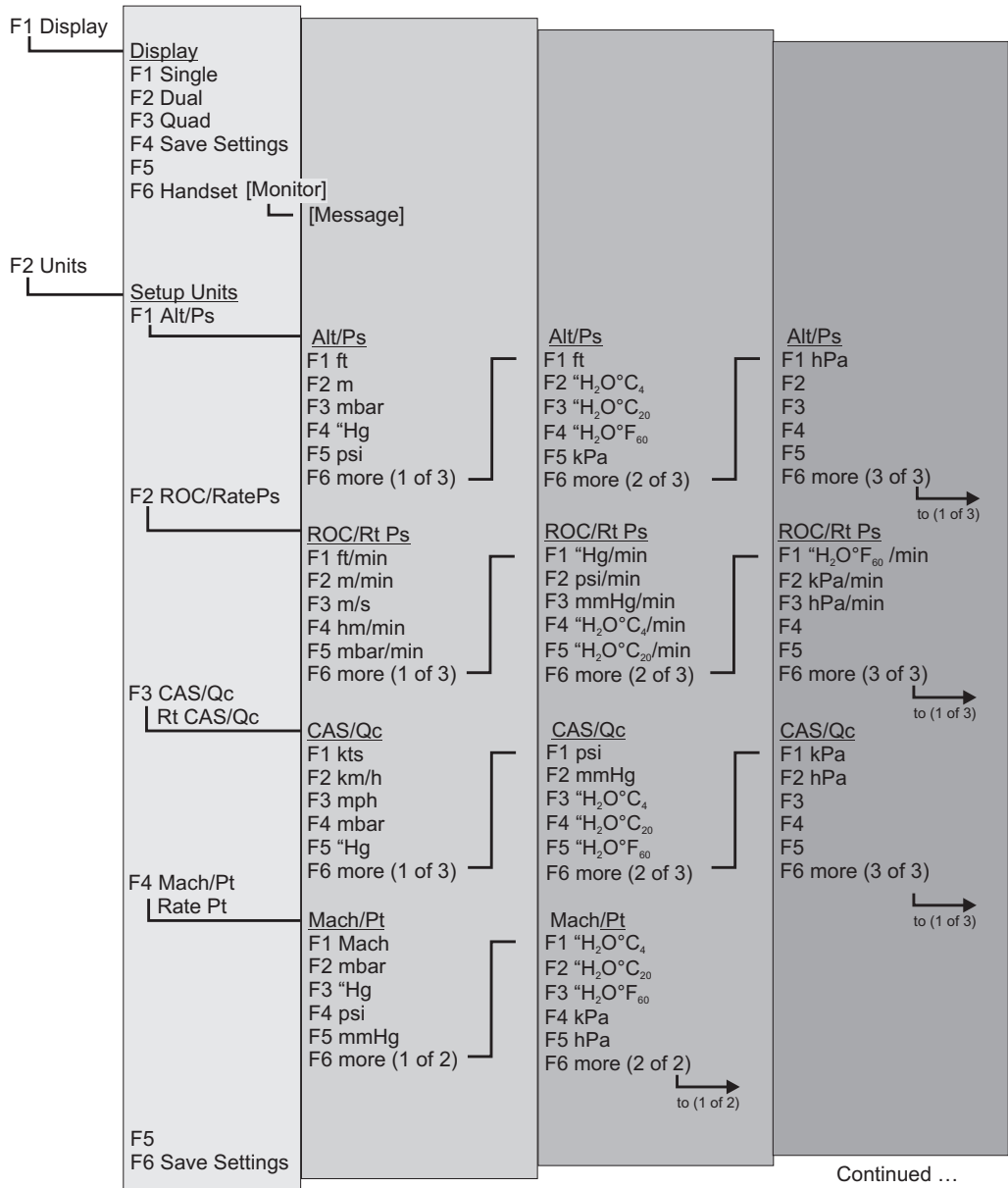

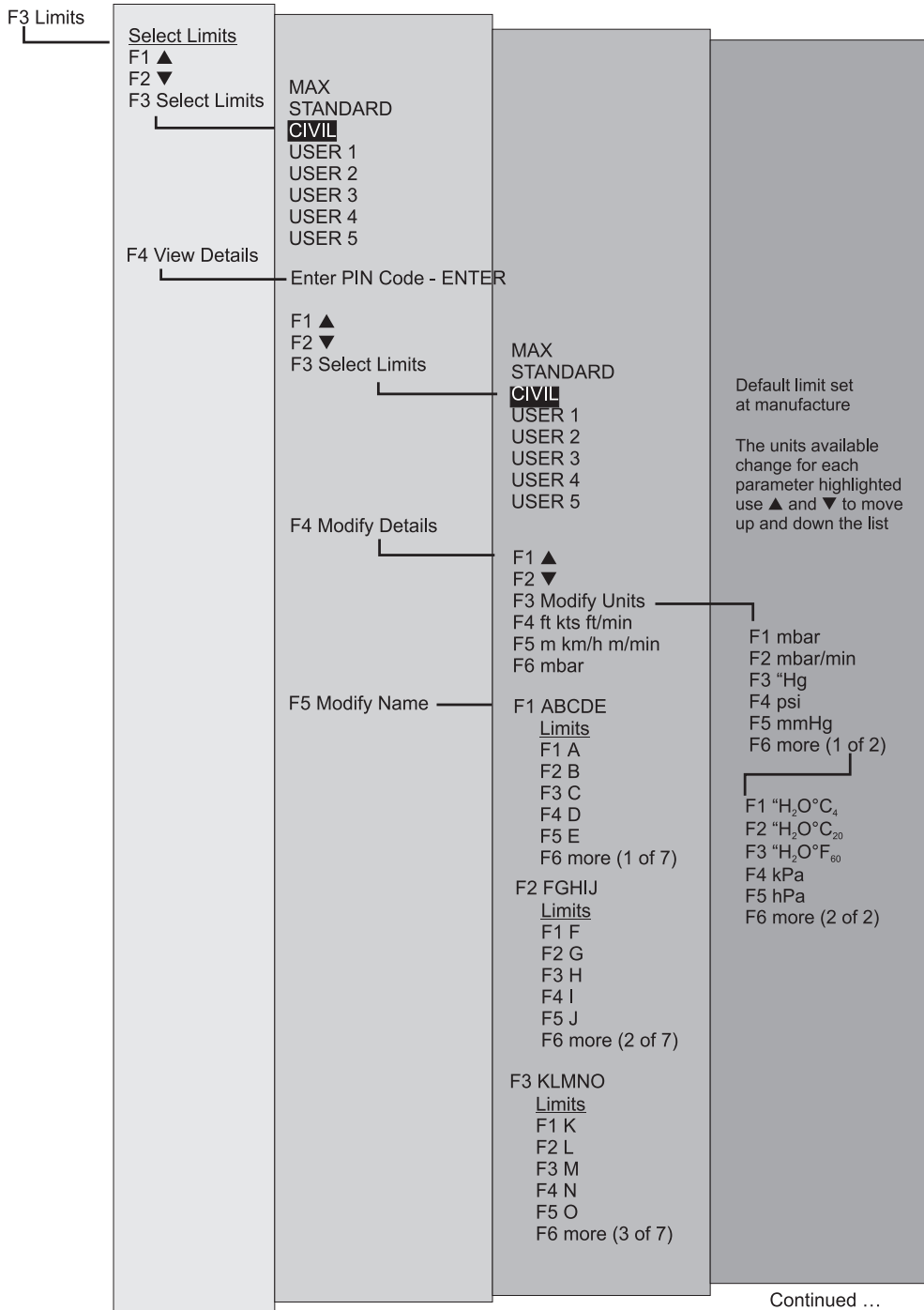

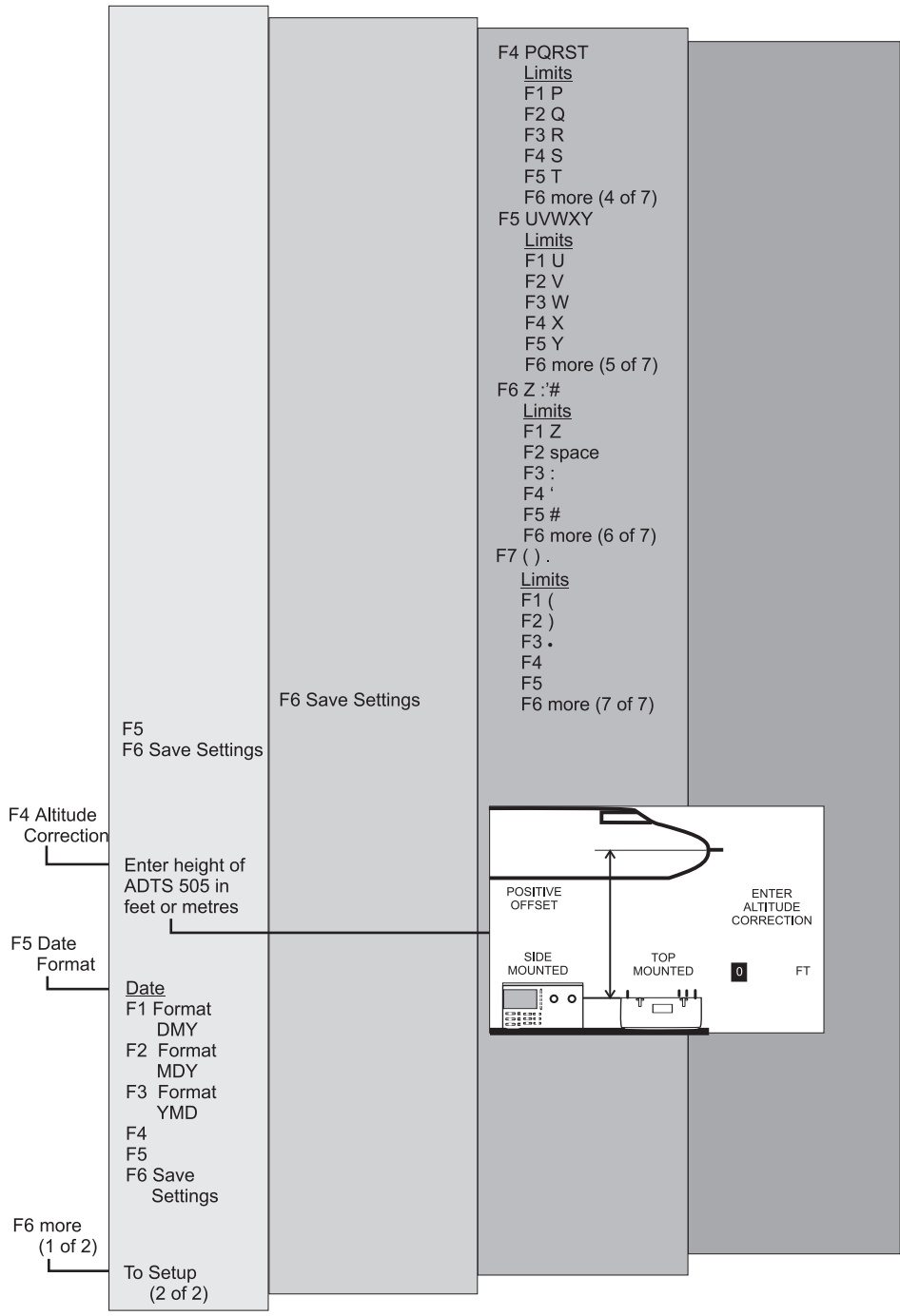

Continued ...

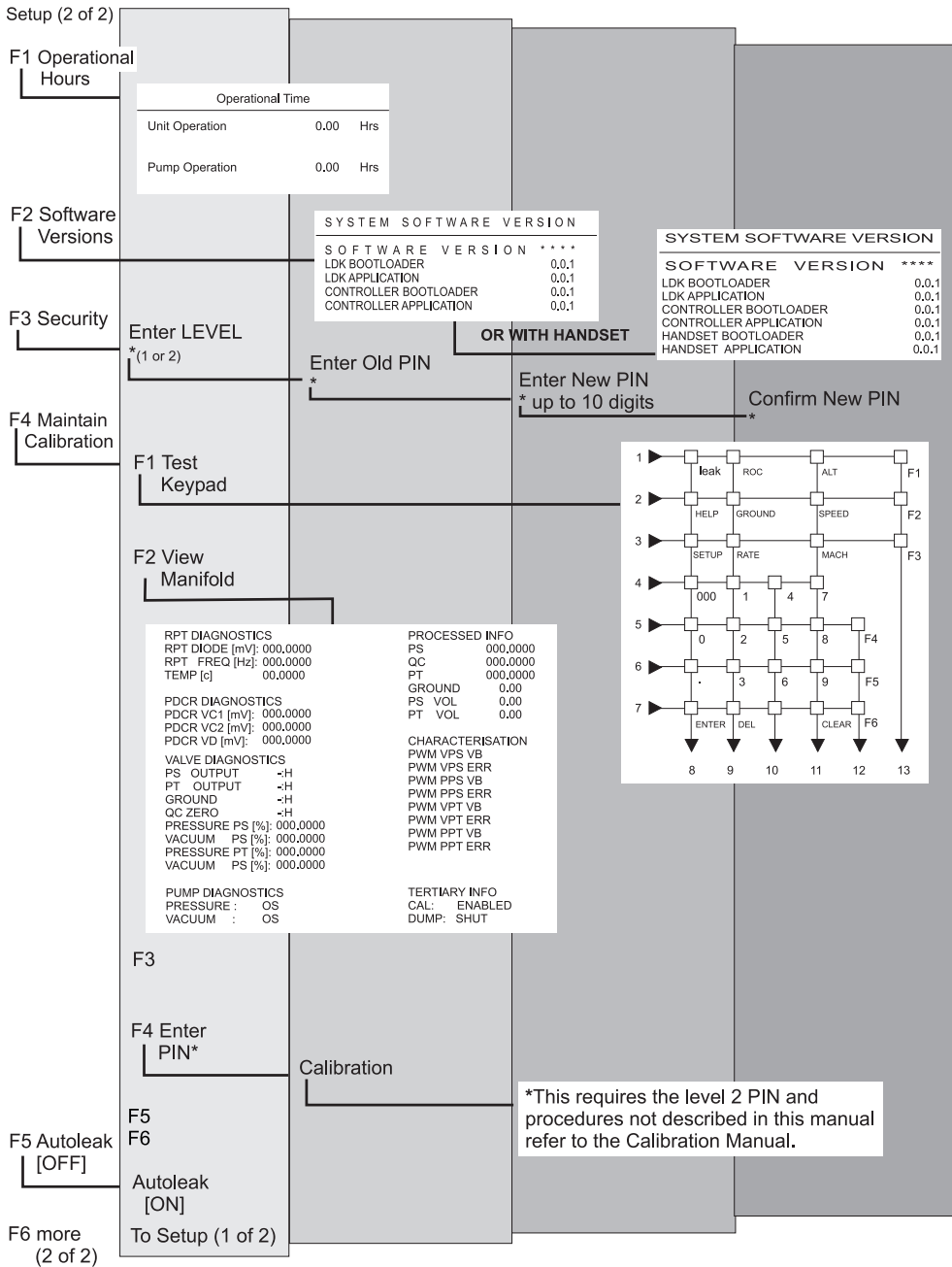

4 MAINTENANCE

4.1 Introduction

This section details the maintenance tasks to be carried out by the operator. The maintenance chart shows the maintenance tasks, the periodicity of each task and a code referenced to the task detailed in 4.3.

Task	Code	Period
Inspect	A	Daily, before use.
Inspect	B	Weekly
Test	C	Before use.
Test	D	Daily, before use.
Calibrate	E	Every 12 months *
Replace	F	As detailed in fault finding or when detailed after inspection.
Clean	G	Weekly *
Service	H	1,000 hours recorded by the unit's operational timer or the equipment running log.
Service	J	3,000 hours recorded by the unit's operational timer or 1000 hours recorded by pump operational timer or the equipment running log.

* Periodicity may change depending on usage and environment, refer to the Engineering Authority.

TABLE 4-1 MAINTENANCE CHART



Waste Electrical and Electronic Equipment directive 2002/96/EC

Do not dispose of this product as household waste. Use an approved organisation that collects and/or recycles waste electrical and electronic equipment. For more information, contact one of these:

- our customer service department: Contact us at www.ge-mcs.com
- your local government office.

4.2 Materials and Tools

This section provides lists of the materials and tools required for the user to maintain the ADTS 505.

Item Number	Item Name, Description
1	Cloth, Cotton, Lint-free
2	Alcohol, Isopropyl (MIL-A-10428, Grade A)
3	Detergent, Mild, Liquid
4	Brush, Soft-bristle (MIL-B-43871)

Note: Equivalent substitutes can be used.

TABLE 4-2 MATERIALS LIST

Ref Code	Nomenclature	Manufacturer's part number
1	Voltmeter, Digital	GE DPI620
2	Insulation Tester, 250V	Robin

Note: Equivalent substitutes can be used.

TABLE 4-3 TOOL AND TEST EQUIPMENT REQUIREMENTS

4.3 Maintenance Tasks

- A Check that all the equipment is present; record any deficiencies. Visually inspect the external of the ADTS 505, and its associated equipment, for obvious signs of damage, dirt, and the ingress of moisture. If necessary, use mild liquid detergent (item 3, Table 4-2) and a lint-free cloth (item 1, Table 4-2) to clean the external surfaces.
- Inspect the pressure outlet ports for ingress of dirt and moisture, clean if necessary with a lint-free cloth.
- B Visually inspect the pneumatic output connectors for damage. Inspect the small o-ring on each pneumatic output connector for cuts and any signs of wear; replace as necessary. Visually inspect pneumatic hoses, electrical cables for cuts, splits and damage; replace as necessary.
- C Before use, power-up the unit as detailed in Section 3. Check the date of the last calibration and, if necessary, refer to task E. Record any error messages and refer to Section 5.
- D Daily and before use, carry out the SST detailed in Section 5.
- E Normal calibration period 12 months. When calibration is due, the unit should be withdrawn from service and returned to depot or calibration facility. The date of calibration is stored in the unit and displayed in the power-up sequence and on a label on the front panel. Do not use a unit with out-of-date calibration. Engineering authority may change the periodicity of calibration depending on usage and the operating environment.
- F As detailed in fault finding or when detailed after inspection replace the listed item in A and B.
- G Depending on the level of use and the cleanliness of the operating environment, clean the unit at regular intervals. Clean the front panel with a damp lint-free cloth (item 1, Table 4-2) and mild liquid detergent (item 3, Table 4-2). Remove any stubborn dirt using isopropyl alcohol (item 2, Table 4-2) and allow to dry. Clean all pneumatic connectors with a soft brush (item 4, Table 4-2). Remove any stubborn dirt using isopropyl alcohol (item 2, Table 4-2) and allow to dry.
- H Withdraw the unit from service and return to the repair depot.
- J Withdraw the unit from service and return to the repair depot.

4.4 Routine Maintenance

WARNING: SWITCH OFF AND DISCONNECT THE POWER SUPPLY BEFORE STARTING ANY MAINTENANCE TASK.

Carrying out the maintenance tasks detailed 4.3.

Servicing Procedures

The following procedures provide instructions to test and replace items for the operator. Return the unit to the repair depot for further testing and replacement of items.

Replacing the output connector o-ring

After inspection as detailed in maintenance task B, carry out the following if the o-ring is worn or damaged:

Carefully remove the o-ring from the small groove at the top of the connector.

Fit a new o-ring in the small groove at the top of the connector.

Make sure the o-ring is tight in the groove and not damaged after fitting.

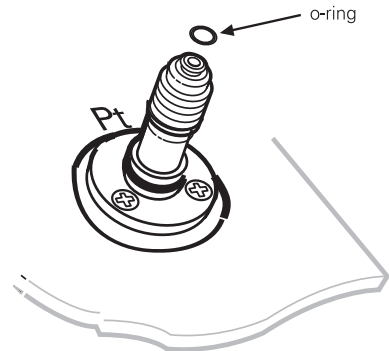

Note: *Damage to this o-ring causes leaks.*

Fuse Replacement (Fig 4-1)

Replace the fuse when detailed in Section 5, Testing and Fault Finding:

- Set the power switch to OFF.

Note: The power switch is not a power isolator as defined by EN61010.

- Isolate the power supply to the instrument by disconnecting the power supply connector (1).
- Unscrew and remove the fuse cap (2) and fuse cartridge (3) from the front panel and replace the fuse cartridge (3).

Note: Fit the correct type of fuse detailed in Section 2, Installation and on the front panel.

- Refit the fuse cap (2) and fuse cartridge (3) to the front panel.
- Reconnect power supply connector (1).
- Switch on the power supply. The instrument should now be operational.
- If a fuse blows immediately on switch-on, contact the manufacturer or Service Agent.

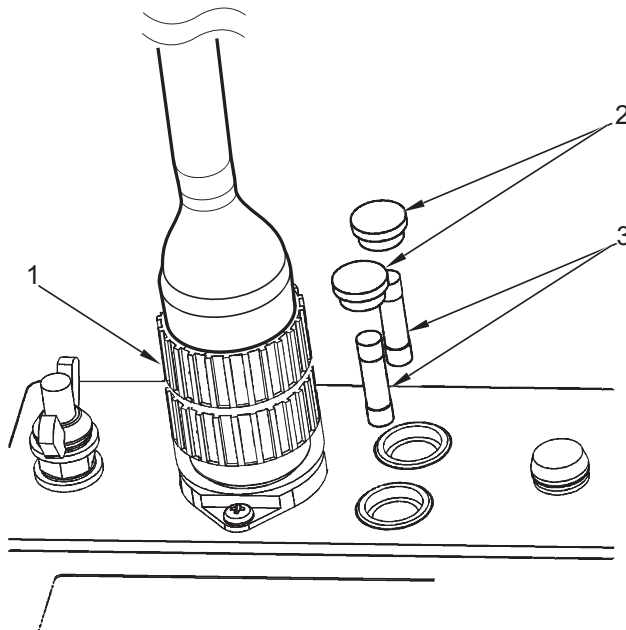

FIGURE 4-1 FUSE REPLACEMENT

Hand Terminal Cable Tests

Carry out the following check as detailed in Testing and Fault Finding, Section 5.

Measure continuity using the DVM (item 1, Table 4-3) set to an appropriate range.

Measure the continuity between corresponding pins at each end of each cable assembly. The measured resistance must not exceed 0.10Ω .

Measure insulation using the Insulation tester (item 2, Table 4-3), set to an appropriate range.

Measure the insulation resistance between the shell of the connector and all individual pins in turn.

Measure the insulation resistance between the shell of the appropriate connectors and all pins in turn.

Measure also the resistance between individual pairs of pins (i.e., 1-2, 1-3, 1-4, 1-5, 1-6, 2-3, 2-4, 2-5, 2-6, 3-4, 3-5, 3-6, 4-5, 4-6 and 5-6). In all cases the resistance must exceed 10 Mohms.

5 TESTING AND FAULT FINDING

5.1 Introduction

- ◆ The ADTS 505 contains a built-in, self-test and diagnostic system. The system continuously monitors the performance of the unit and at power-up carries out a self-test. Warning and error messages are displayed during normal operation if out of range values are entered or if faults occur.
 - ◆ This section details the standard serviceability test and the possible error messages and codes that can be displayed. A fault diagnosis flow chart and table provide the probable cause and procedures to rectify specific symptoms.
- Error messages**
- ◆ When the display shows a message indicating entry of incorrect data or values, pressing CLEAR/QUIT clears the message and allows the correct entry to be made.

5.2 Standard Serviceability Test

- ◆ The following procedure shows if the unit is serviceable and checks functions and facilities of the ADTS 505. In this procedure:
 - All key presses are highlighted in **BOLD** and shown as identified on the front panel.
 - Key presses inside brackets e.g., [Units], are soft key presses (i.e., function key selections {F1 to F6} indicated on the screen).

Procedure

- ◆ Connection and power-on checks.
 - Connect power to the unit.
 - Make sure the blanking caps are fitted to the Ps and Pt front panel outputs.
 - Set the power supply switch to ON.
 - Check power indicator is on.
 - Check the display shows the first power-up message.
- ◆ Check the display all the power-up messages.
 - The ADTS 505 displays any detected errors, refer to fault finding.
 - Check that the display then changes to show measured aeronautical or pressure values. This depends on the display set-up.

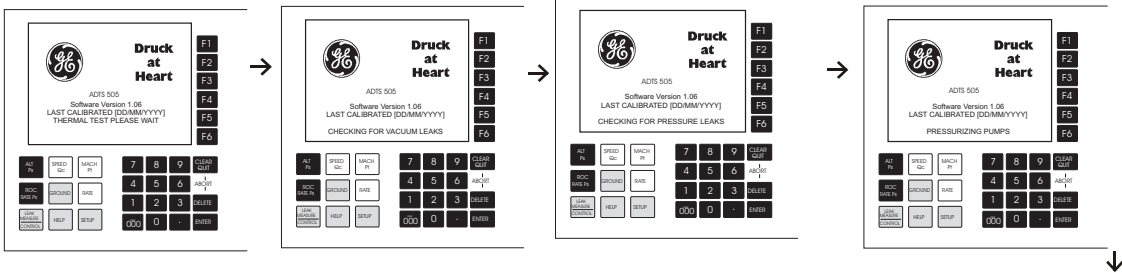
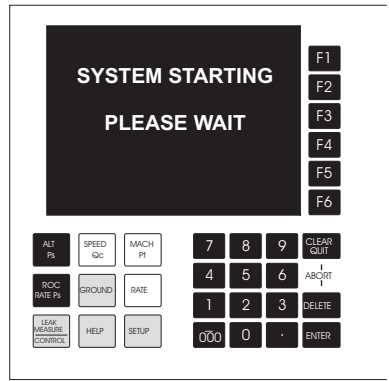

NOTES

1 The displayed values change as atmospheric pressure changes at power-up.

2 The unit requires 15 minutes to warm-up to achieve full accuracy and stability.

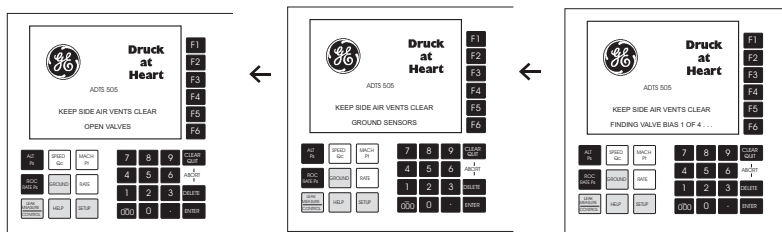

- Set the display to QUAD format (see 3.4.1 to change) and aeronautical units of ft, kts and ft/min (see 3.5.5 to change).
- Press **ALT/Ps**, **ROC/RtPs**, **SPEED/Pt** and **RATE** to display the required parameters.
- Press **LEAK MEASURE/CONTROL** to go to control mode.
- Set the ROC/RtPs to 5000 ft/min.
- Enter an altitude aim of 500 ft and an airspeed aim of 400 knots.
- Check that these aim values are achieved, the rate of change are within the selected rates and that the achieved aim values are stable.

Completion

- ◆ Press **GROUND**, wait until the display shows 'Safe at Ground'. On successful completion of this test procedure, switch off and disconnect the power supply.

5.3 Fault Diagnosis

- ◆ If a fault occurs, refer to the fault location chart, Figure 5-1 and Table 5-1 for possible fault causes and recommended action.
- ◆ If the display shows a warning or error message, refer to the section below.
- ◆ If a pneumatic leak or controller is suspect refer to section 5.5.

5.4 Warnings and Self-Test Errors

- ◆ At power-up, the ADTS 505 indicates if there is a fault by displaying an error code and message.
- ◆ See 5.6 for the tables listing the error codes, check that the error code is complete and listed in the table before returning the unit to the repair depot.
- ◆ During normal operation the display can show a warning message, see 5.6 for the tables listing the warning messages, probable cause and recommended action.

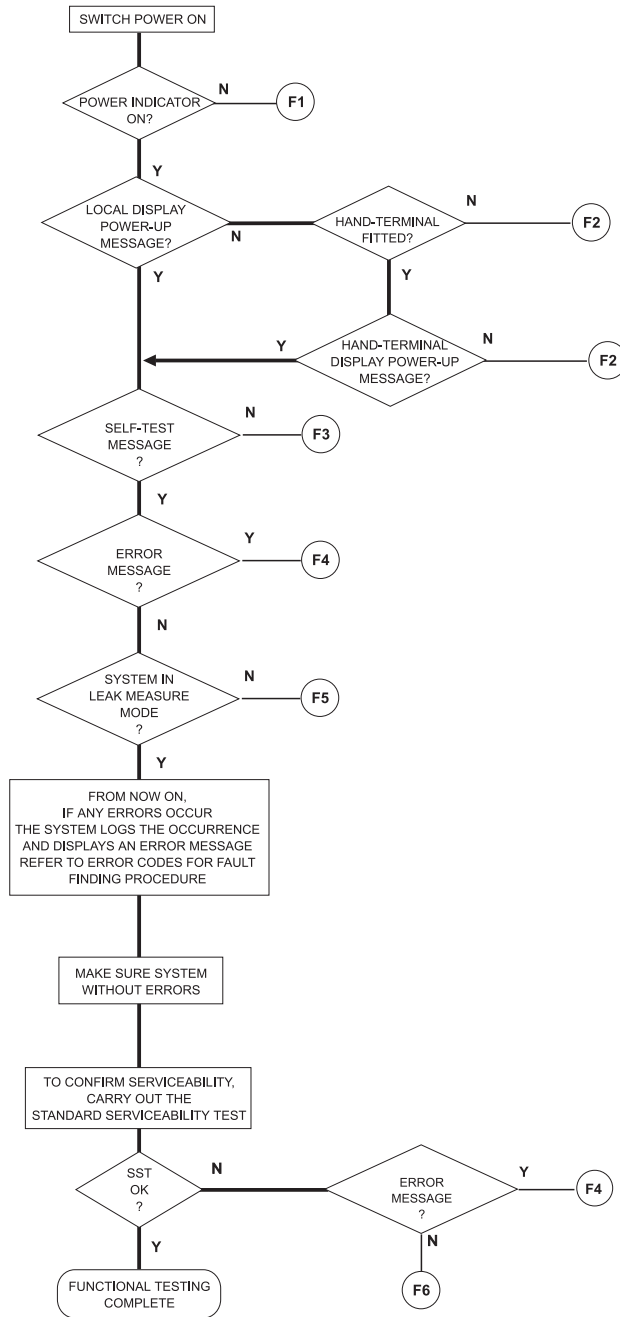

FIGURE 5-1 FAULT FINDING CHART

TABLE 5-1 FAULT FINDING

Fault	Symptom	Probable cause	Action
F1	Power supply indicator does not light.	Faulty power supply outlet. Unserviceable power supply front panel fuse. Faulty power supply cable. Internal power supply fault.	Check power supply. Check/replace fuse. Check/replace fuse. Replace cable and re-test. Record fault and return ADTS 505 to depot for repair.
F2	Power supply indicator lights, no display.	Internal fault.	Record fault and return ADTS 505 to depot for repair.
F3	No self-test message.	Internal fault.	Record fault and return ADTS 505 to depot for repair.
F4	Display shows error message.	Error detected.	Refer to fault finding tables.
F5	Display does not show Leak Measure mode.	If display stops at Thermal Test. System component fault.	Allow ADTS 505 to reach ambient temperature. Record fault and return ADTS 505 to depot for repair.
F6	Fails SST.	Internal leak. Internal fault.	Refer to further testing 5.5.

5.5 Further Testing

The following tests should only be carried out if a pneumatic leak or a controller instability is suspected.

Test Environment and Preliminary Operations

These tests should be carried out in a room with a stable temperature environment within the operating temperature range. The room must be free from drafts.

- ◆ Review and become familiar with the whole of the test procedure before beginning the test procedure.
- ◆ The unit must be thermally stable; switch on and leave the unit for at least one hour to achieve thermal stability.
- ◆ Make sure the blanking caps are fitted to the Ps and Pt front panel outputs.
- ◆ Change the units to mbar as follows:
 - (1) Select [UNITS] then select mbar and mbar/min.
 - (2) Select [Save/Lock] and then press **CLEAR/QUIT** and the display now shows ALT/Ps and Speed/Qc in units of mbar.
- ◆ Change the pressure limits to MAX as follows:
 - (1) Press **SETUP** then select [LIMITS].
 - (2) Use [▲] or [▼] to move through the list and press F3 to select MAX limits.

On-screen Assessment (Figure 5-2)

- ◆ This procedure enables real time assessment of the system. Each valve and transducer is characterized to obtain maximum performance. Any values shown on the screen are an indication and not a precise value.

To assess the system, enter a set-point and a rate so that achieving the set-point takes at least 5 minutes. Once set and controlling, select setup and display the system data screen using the menu selection below

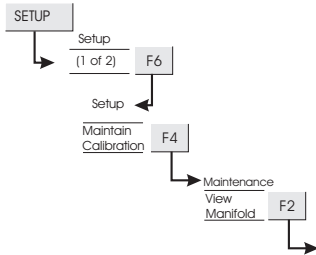

RPT DIAGNOSTICS
 RPT DIODE [mV]: 000.000000
 RPT COUNT: 0000000
 TEMP [C] 00.000000
PDCR DIAGNOSTICS
 PDCR VC [mV]: 000.0000
 PDCR VD [mV]: 000.0000

PROCESSED INFO
 PS 000.000000
 QC 000.0000
 PT 000.000000
 GROUND 000.000000
 PS VOL 0.000000
 PT VOL 0.000000

VALVE DIAGNOSTICS
 PS OUTPUT L:L
 PT OUTPUT L:L
 GROUND -:-
 QC ZERO -:-
 PRESSURE PS [%]: 0000
 VACUUM PS [%]: 0000
 PRESSURE PT [%]: 0000
 VACUUM PT [%]: 0000

CHARACTERISATION
 PWM VPS VB 0000.000000
 PWM VPS ERR 00.000000
 PWM PPS VB 0000.000000
 PWM PPS ERR 00.000000
 PWM PPT VB 0000.000000
 PWM PPT ERR 00.000000
 PWM VPT VB 0000.000000
 PWM VPT ERR 00.000000

PUMP DIAGNOSTICS
 PRESSURE : POF
 VACUUM : VOF

TERTIARY INFO
 CAL: ENABLED
 DUMP: SHUT

FIGURE 5-2 SYSTEM SCREEN FOR DIAGNOSIS

Data Identifier	Function	Expected Display or Value
RPT Diagnostics	Ps/Altitude Sensor	
RPT Diode [mV]	Temperature Compensation	400 (hot) 800 (cold)
RPT Count	Value proportional to pressure	248,5534,473,600
TEMP [c]	Ps channel (RPT) measured temperature	5° 60°C (over permitted ambient range)
PDCR Diagnostics	Qc/Airspeed Sensor	
PDCR Vc [mV]	Temperature Compensation	980 2100
PDCR Vd [mV]	Value proportional tp pressure	0 to 140 mV (always active)
Valve Diagnostics	Pressure Output and Control	
Ps Output	Ps Port isolation valve state	L:L <-> H:H (open) -:- (closed)
Pt Output	Pt Port isolation valve state	L:L <-> H:H (open) -:- (closed)
Ground	Ground pressure sense valve state	-:- (closed, normal), H:H (at ground)
Qc Zero	Qc auto-zero valve state	-:- (closed, normal), H:H (at ground, auto-zero)
Pressure Ps	Ps pressure valve drive level	0 (Leak/Measure), varying to 9999 (control)
Vacuum Ps	Ps vacuum valve drive level	0 (Leak/Measure), varying to 9999 (control)
Pressure Pt	Pt pressure valve drive level	0 (Leak/Measure), varying to 9999 (control)
Vacuum Pt	Pt vacuum valve drive level	0 (Leak/Measure), varying to 9999 (control)
Pump Diagnostics	Controller Source Pressures	
Pressure	Pressure pump drive state	POV (Pressure On Flow) or blank (pump off)
Vacuum	Vacuum pump drive state	VOF (Vacuum On Flow) or blank (pump off)
Processed information	Major Measurement/Control Parameters	
Ps	Ps Channel Pressure, mbar absolute	0 to 1355
Qc	Qc Channel Pressure, mbar differential	-1355 to 2490
Pt	Pt Channel Pressure, mbar absolute	0 to 3845
ground	Ambient pressure estimate	800 to 1300
Ps VOL	System Ps volume estimate	0.125 (min) varies with connected system
Pt VOL	System Pt volume estimate	0.125 (min) varies with connected system
Characterisation	Control Valve Data	
PWM PPS VB	Valve bias (VB) calculated in real time	Variable with temperature
PWM PPS ERR	Determined during manufacture or service operations	Constant
PWM VPS VB	Valve bias (VB) calculated in real time	Variable with temperature
PWM VPS ERR	Determined during manufacture or service operations	Constant
PWM PPT VB	Valve bias (VB) calculated in real time	Variable with temperature
PWM PPT ERR	Determined during manufacture or service operation	Constant
PWM VPT VB	Valve bias (VB) calculated in real time	Variable with temperature
PWM VPT ERR	Determined during manufacture or service operations	Constant
Tertiary Information	Other system control states	
CAL:	Calibration lock switch state	Disabled (normal)
DUMP:	Pump pressure vent state	Shut (normal)

TABLE 5-2 SYSTEM SCREEN INFORMATION

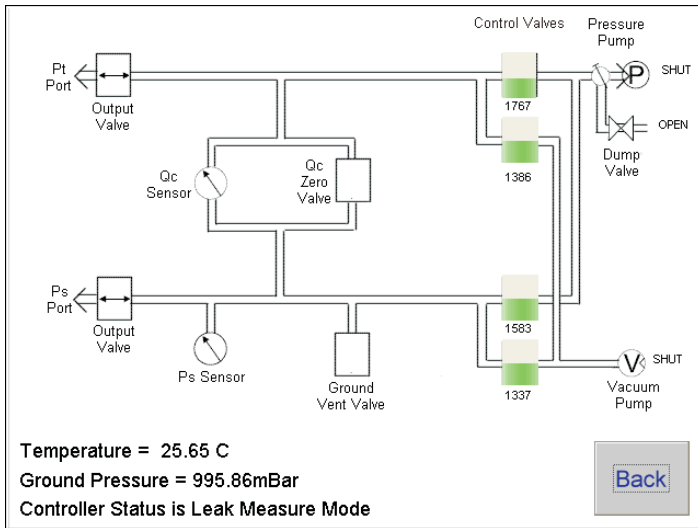
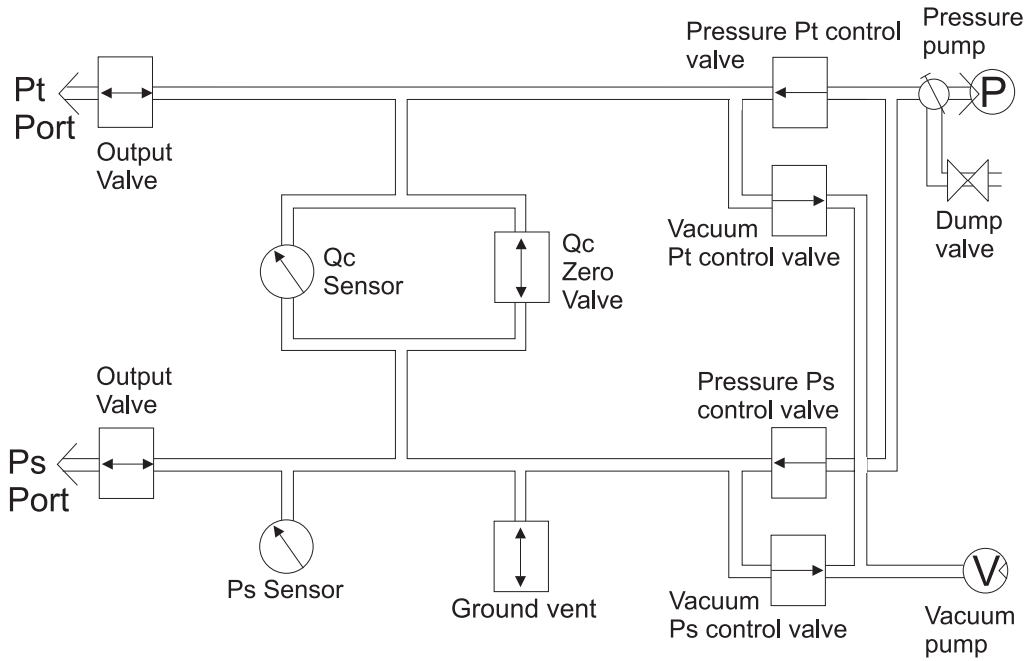

Schematic shown on the advanced hand terminal

FIGURE 5-3 SYSTEM SCHEMATIC

Key-pad Testing

- ◆ The front panel key-pad and the hand terminal key-pad can be tested using the facility in the maintenance/calibration selection of the set-up menu.

The procedure to test the key-pad requires each key to be pressed in turn and to confirm the correct key press on the display. Make sure the display shows only the appropriate key press.

Note:

Connecting the hand terminal disables the front panel key-pad.

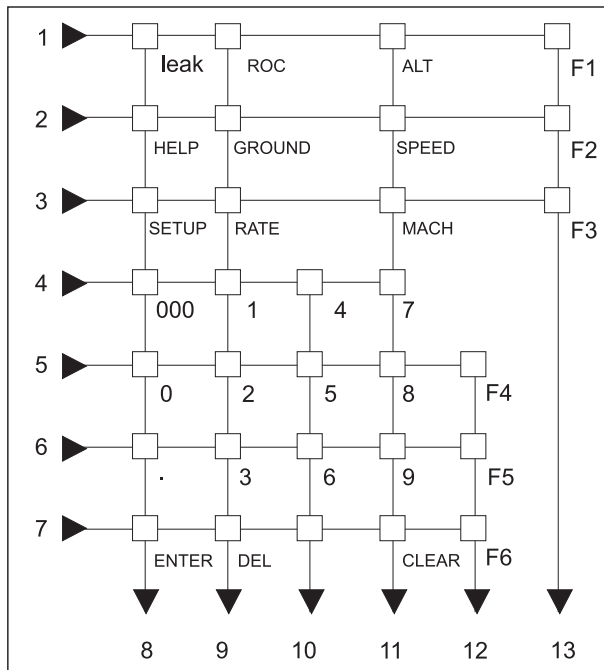

FIGURE 5-4 KEY-PAD TEST DISPLAY

Pressure leak check

- ◆ This procedure verifies that the unit is leak tight under positive pressure conditions.
 - (1) Press **LEAK MEASURE/CONTROL** to enter control mode.
 - (2) Enter an ALT/Ps Aim of 1016 mbar.
 - (3) Enter a SPEED/Qc Aim of 272 mbar. Wait for the aim values to be achieved then wait for 1 min.
 - (4) Press **LEAK MEASURE/CONTROL** to return to Leak Measure mode.
 - (5) Select [Rate Timer] and select [Set Wait 05:00], [Set Time 01:00] and then select [Start Timing].
 - (6) At the end of the timing period, the display shows the rate of change of Ps, Qc and Pt.
 - (7) Check that the Ps, Qc and Pt rates are less than or equal to ± 0.5 mbar/min. If the leak rate is not achieved, allow further thermal stabilization time and re-test by selecting [Rate Timer] and selecting [Set Wait 05:00], [Set Time 01:00].
 - (8) Press **CLEAR/QUIT** to exit rate timer display.

Vacuum leak check

- ◆ This procedure verifies that the unit is leak tight under vacuum conditions.
 - (1) Press **LEAK MEASURE/CONTROL** to enter control mode.
 - (2) Enter an ALT/Ps Aim of 100 mbar.
 - (3) Enter a Speed/Qc Aim of 0 mbar.
 - (4) Wait the required time for temperature stabilization e.g., one minute. Press **LEAK MEASURE/CONTROL** return to Leak Measure mode.
 - (5) Select [Rate Timer] and select [Set Wait 05:00], [Set Time 01:00] and then select [Start Timing].
 - (6) At the end of the timing period, press **ROC/RtPs** to display the measured rate of change of ALT/Ps.
 - (7) Check that the Ps, Qc and Pt rates are less than or equal to ± 0.5 mbar/min. If the leak rate is not achieved, allow further thermal stabilization time and re-test by selecting [Rate Timer] and select [Set Wait 05:00], [Set Time 01:00].
 - (8) Press **CLEAR/QUIT** to exit rate timer display.

Range check

- ◆ Control the Ps and Qc pressures to the normal limits of operation and make sure that these are achieved. Use minimum Ps and zero Qc and then maximum Ps and maximum Qc.

Note: *Do not exceed the maximum Pt as shown on the front panel of the unit. Use maximum available rates of change to minimise test times.*

Controller Stability

- ◆ This section verifies the control stability.
 - (1) Press **LEAK MEASURE/CONTROL** to turn the pressure controllers on.
 - (2) Enter an ALT/Ps Aim of 510 mbar with a rate of change of 204 mbar/min.
 - (3) Enter a Speed/Qc Aim of 0 mbar with a rate of change of 204 mbar/min.
 - (4) Press **ALT/Ps** and wait for the aim values to be achieved.
 - (5) Observe the measured values of Ps and Qc on the display for 1 min.
 - (6) Check that the displayed value of Ps remains within ± 0.068 mbar.
 - (7) Check that the displayed value of Qc remains within ± 0.068 mbar.

5.6 Fault Finding

System Messages

- ◆ In the event of a malfunction, the built-in, self-test and diagnostic system displays a message and a code. The message heading **Error** indicates a fault or condition that interrupts normal operation. The following tables list the error messages with the probable cause and action to be taken.
- ◆ If the display shows a message not listed in the tables the unit must be switched off. If the display shows the same non-operational message after switching on, the unit should be returned to the repair depot.

No.	Message	Probable Cause	Action
7	Autoleak recovery activated	Excessive leak rate detected in Ps/Qc pressures	Check hoses and aircraft systems for leaks
31	Test set must be at ground	Invalid user request	Select Go to Ground first
32	Pressure leak in Ps.	Leaking Ps channel pressure control valve.	Return unit to repair depot.
33	Pressure leak in Pt.	Leaking Pt channel pressure control valve.	Return unit to repair depot.
36	Ps Aim Overshoot.	Connected system leak rate changing.	Check hoses and aircraft systems for leaks.
37	"Ps aim value unobtainable".	Leak rate on Ps too high to control.	Check port caps, hoses and connectors for leaks.
40	Pt Aim Overshoot.	Connected system leak rate changing.	Check hoses and aircraft systems for leaks.
41	"Pt aim value unobtainable".	Leak rate on Pt too high to control.	Check port caps, hoses and connectors for leaks.
4	Vacuum leak in Ps.	Leaking Ps channel vacuum control valve.	Return unit to repair depot.
4	Vacuum leak in Pt.	Leaking Pt channel vacuum control valve.	Return unit to repair depot.
4	Ps pressure control valve cannot be calibrated.	Valve fault.	Return unit to repair depot.
56	Stabilising Qc to Zero.	Possible negative airspeed detected, possible sudden leak.	System zero valve opened to stop negative airspeed condition.
57	Current Pressure Limits Exceeded.	Limits for Ps or Qc exceeded.	Make sure pressures are within limits, check leak rates.

TABLE 5-3 ERROR MESSAGES

Note: In No. 56, this safety feature opens the zero valve. If this happens constantly, check for leaks.

No.	Message	Probable Cause	Action
219	Abort sequence started by user	Abort key pressed on hand terminal	Wait until system completes abort sequence
220	"Cannot Modify Altitude Correction in Pressure Units"	Altitude Correction	Change units in setup to aero units
221	"Changed Aim to ARINC Limit"	Value out of ARINC limit range	Re-enter value within allowed range
222	Calibration data failed	Incorrect pressure value entered during calibration	Check and enter correct pressure value for reference pressure point
223	"Cannot enter EPR in Aero Units"	EPR selected with aero units displayed	Change units in setup to pressure units then select EPR
227	"Changed Aim to Current Limit"	Value out of limit range	Re-enter value within allowed range
228	"Limit Overlap"	Value conflicts with limit ranges	Re-enter value within allowed range
229	"Limit Saved"	Value out of acceptable range	Re-enter value within allowed range
241	"Ground Request in Leak Mode"	System must be in control mode	Select control mode
243	"LDK has an invalid EEPROM archive"	Invalid/corrupted data - recovery in progress	Check custom limit sets not lost
245	"Controller has an invalid EEPROM archive"	Invalid/corrupted data - recovery in progress	Check/correct calibration
247	"Handset has an invalid EEPROM archive"	Invalid/corrupted data - recovery in progress	
250	"Vacuum pump processor has failed"	Internal fault	Return unit to repair depot
251	"Vacuum pump lead is disconnected"	-	Return unit to repair depot
252	"Vacuum pump transistor is faulty or drive inhibited"	Internal fault	Return unit to repair depot

TABLE 5-3 ERROR MESSAGES (CONTINUED)

No.	Message	Probable Cause	Action
253	"Vacuum pump has stalled"	Internal mechanical fault	Restart system, if fault repeats -return unit to repair depot
254	"Pressure pump processor has failed"	Internal fault	Return unit to repair depot
255	"Pressure pump lead is disconnected"	-	Return unit to repair depot
256	"Pressure pump transistor is faulty or drive inhibited"	Internal fault	Return unit to repair depot
257	"Pressure pump has stalled"	Internal mechanical fault	Restart system, if fault repeats - return unit to repair depot
260	"Connected handset has failed to respond. Disconnecting power."	Handset bad connection or comms/power supply fault	Check connections and restart, if fault repeats - return unit to
261	"Calibration switch has not enabled."	Switch not selected	Set calibration switch
262	"Valve characterisation data is invalid. Restoring from FLASH."	Invalid/corrupted data, recovery in progress	Allow for complete recovery before continuing
263 to 290	"Valve constant out of range"	Essential system data failure	Return unit to repair depot
293	"Limit entry changed to MAX limit set"	User tried to enter limit out of range of instrument	Re-enter within maximum range of instrument
295	"CAS is outside MAX limits"	Differential pressure applied at Ps/Pt ports over-range	Check/reduce Ps/Pt pressure applied to ADTS 505
296	"Alt is outside MAX limits"	Pressure applied at Ps port over-range	Check/reduce Ps pressure applied to ADTS 505
297	"ROC is outside MAX limits"	Rate of pressure change at Ps port too high	Check/correct hose or aircraft system Ps leak
298	"Qc is outside MAX limits"	Differential pressure applied at Ps/Pt ports over-range	Check/reduce Ps/Pt pressure applied to ADTS 505
299	"Ps is outside MAX limits"	Pressure applied at Ps port over-range	Check/reduce Ps pressure applied to ADTS 505
300	"RtPs is outside MAX limits"	Rate of pressure change at Ps port too high	Check/correct hose or aircraft system Ps leak
309	"Hand terminal short circuit"	Faulty cable or hand terminal	Check cable, if necessary, replace hand terminal
312	"RtCAS is fixed and cannot be altered"	User attempted to enter alternative RtCAS aim	None, RtCAS is pre-set and locked at 300kts/min
313	"Calibration data not entered. Enter calibration date"	Date entry step missed in calibration procedure	Enter date field requested

TABLE 5-3 ERROR MESSAGES (CONTINUED)

Additional Messages

Internal temperature

- ◆ The temperature sensor in the pressure measurement system measures the temperature of the pressure manifold. At a temperature greater than 60°C the sensor triggers an overheat fault. In measure mode, the display flashes between the normal aim/measure screen and "Ps Sensor Outside Calibrated Range". In control mode, the display shows "CONTROL HALTED" the system stops controlling and switches off the pumps. When the sensor detects a temperature of 55°C the display stops flashing.
- ◆ Before re-entering control mode check the air vents for obstructions. To re-enter control mode press **LEAK MEASURE/CONTROL** twice. If this overheat fault happens again switch off the unit and return to repair depot.

Intentionally left blank

6 REFERENCE AND SPECIFICATION

6.1 Introduction

This section includes a full description of each key-pad selection and function, the main menu selections and functions and set-up selections and functions.

The available keys are:

F1 - F6
ALT Ps
SPEED Qc
MACH Pt
ROC Ps RATE
RATE
LEAK MEASURE/CONTROL
GROUND
HELP
SETUP
0 to 9
- 000
CLEAR/QUIT
DELETE
ENTER
.

Double key press:

ABORT (CLEAR/QUIT + ENTER)

6.2 Key-pad Selections and Functions

F1 - F6

- ◆ These function keys or soft-keys are used to select choices from menus. The main menu choices are shown next to the keys. After making a menu choice, the display shows further selections in a sub-menu or the display changes indicating a successful selection.
- ◆ When a sub-menu is displayed, press the appropriate function key to select the required choice.
- ◆ **CLEAR/QUIT** can be used to leave a sub-menu without making a selection.

ALT Ps

- In aeronautical units (ft or m), this key selects an altitude display.
- In pressure units (mbar, inHg etc.), this key selects a static pressure (Ps) display.
- Select [Units], from the main menu, to change the display units.
- Before entering a new altitude or Ps aim, set the rate of change using the **ROC/RATEPs** key.
- When in Control Mode (Aim display), enter a new altitude or Ps aim using the numeric keys. Use **LEAK MEASURE/CONTROL** to change between Control and Leak Measure mode.

SPEED Qc

- In aeronautical units (kts, km/h), this key selects an airspeed (CAS) display. In pressure units (mbar, inHg etc.), this key selects dynamic pressure and the display shows (Qc).

Note: *For testing purposes, Calibrated Airspeed (CAS) equates to Indicated Airspeed (IAS).*

- If the altitude aim is changed, after the entry of CAS, the Mach aim value changes while the CAS value remains unchanged.
- If the altitude aim is changed, after the entry of Mach, the CAS aim value changes while the Mach value remains unchanged.
- If the Ps aim is changed, after the entry of Qc, then the Pt aim value changes while the Qc remains unchanged.
- If the Ps aim is changed, after the entry of Pt, then the Qc aim value changes while the Pt remains unchanged.
- Select [Units], from the main menu, to change the display units.
- The rate of change is fixed at 300 kts/min or equivalent.
- When in Control Mode (AIM display), a new CAS or Qc can be entered using the numeric keys. Use **LEAK MEASURE/CONTROL** to change between Control and Leak Measure mode.

MACH Pt

- In aeronautical units (ft/kts or m/km/h), this key selects the Mach display.
- In pressure units (mbar, inHg etc.), this key selects the total pressure (Pt) display.
- If the altitude aim is changed, after the entry of CAS, the Mach aim value changes while the CAS value remains unchanged.
- If the altitude aim is changed, after the entry of Mach, the CAS aim value changes while the Mach value remains unchanged.
- If the Ps aim is changed, after the entry of Qc, then the Pt aim value changes while the Qc remains unchanged.
- If the Ps aim is changed, after the entry of Pt, then the Qc aim value changes while the Pt remains unchanged.
- When in Control Mode (AIM display), a new Mach or Pt aim can be entered using the numeric keys, Use **LEAK MEASURE/CONTROL** to change between Control and Leak Measure mode.

ROC Ps RATE

- In aeronautical units (ft or m), this key selects the Rate of Climb (ROC) or vertical speed display.
- In pressure units (mbar, inHg etc.), this key selects the rate of change of Ps display.
- Select [UNITS], from the main menu, to change between aeronautical and pressure units.
- When in Control Mode (AIM display), a new ROC or Ps rate can be entered using the numeric keys. Use **LEAK MEASURE/CONTROL** to change between Control and Leak Measure mode. The default control rate set at manufacture is 3000 ft/min.

RATE

- In aeronautical units (kts, km/h), this key shows the rate of change of airspeed (Rate CAS).
- In pressure units (mbar, inHg etc.), this key shows the rate of change of pressure (Rate Qc) display.
- In leak measure mode the display shows the current rate of change. In control mode this key selects the fixed rate of change of airspeed (Rate CAS) of 300 kts/min or the equivalent rate (Rt Qc) in pressure units/min.
- Select [UNITS], from the main menu, to change between aeronautical and pressure units.
- Use LEAK MEASURE/CONTROL to change between Control and Leak Measure mode.

LEAK MEASURE/CONTROL

- This key switches between Control and Leak Measure mode.
- When in leak measure mode, the display shows "LEAK MEASURE".
- Press **LEAK MEASURE/CONTROL** to switch the controllers on. No significant pressure transients are produced when regaining control.
- When in control mode, the display shows "Aim Value".
- A built-in safety feature called auto leak recovery protects the aircraft systems during leak testing.
- Auto Leak recovery automatically regains control if the leak rate is too high on either channel. The trip values are set by the manufacturer to 3000 ft/min and 300 kts/min.
- Auto Leak recovery can be switched on/off by pressing **SETUP**, [Setup 2 of 2], [Auto Leak], ON/OFF.

GROUND

- This key enables the automatic control of the pressures in the aircraft system to return to local atmospheric pressure.

Note:

The "go-to-ground" operates only in control mode.

- The ADTS 505 records local atmospheric pressure during the power-up sequence.
- When **GROUND** is pressed, a prompt asks the user to confirm YES or NO. The system automatically enters an altitude or static aim equivalent to local atmospheric pressure (QFE) and an airspeed or dynamic pressure aim of zero. The system controls pressures towards these aims in the normal way and at the set rates. At any time when going-to-ground, a new rate of change can be entered, the ADTS 505 continues 'going-to-ground'.
- At any time during 'going-to-ground', a new value aim for ALT, CAS, Mach, Ps, Qc or Pt can be entered. This causes the procedure to stop and normal controlling operation to start.
- When the system completes the go to ground the display shows the message 'Safe at Ground' with the ground and zero valves open.
- Press **CLEAR /QUIT** to continue with normal operation. The ground and zero valves then automatically close.

0 to 9

- Use these keys for numeric entry. Press **ENTER** to complete numeric entry. All data entry is based on over-writing the existing value.
- If a mistake is made during numeric entry, press **DELETE** to remove the last entered digit. At any time, the existing value may be recovered by pressing **CLEAR/QUIT**.

Note: *Once the ENTER key has been pressed, the old number cannot be restored.*

-000

- This key performs two functions during numeric entry.
- If it is the first numeric key pressed, it produces a minus sign for the entry of negative numbers.
- If it is not the first key pressed during numeric entry, it produces three zeros for fast entry of thousands e.g. to enter -1000,

Press -000 (Display shows -)

Press 1 (Display shows -1)

Press -000 (Display shows -1000)

Note: *When -000 is pressed during entry of an aircraft name for limits, it always produces “-”.*

CLEAR/QUIT

- During numeric entry, **CLEAR/QUIT** removes the new number and restores the previously entered number.

Note: *Once the ENTER key has been pressed, the old number cannot be restored.*

- When menus are displayed, **CLEAR /QUIT** exits the menu, generally to the previous display.
- When a display contains a [Save/Settings] option, making this selection saves the new settings; pressing **CLEAR /QUIT** restores the old settings. For all other displays, pressing **CLEAR /QUIT** saves the changes.
- When the display shows a warning message, pressing **CLEAR /QUIT** removes the message.

DELETE

- During numeric entry, **DELETE** removes the last digit entered.

HELP

- The HELP key provides information on each key function. The help message generally gives associated functions and ways of changing the use of each key. When the display shows the main pressure display, the user can get help on any of the keys on the key-pad. To do this:
 - Press the required key for information, then press HELP.
 - Press **CLEAR/QUIT** to exit the help system.

ENTER

- Press **ENTER** to complete a numeric entry.

CLEAR/QUIT + ENTER (ABORT)

- When **CLEAR/QUIT** and **ENTER** are pressed simultaneously, the ADTS 505 restarts from the power-up sequence.
- When these keys are pressed all output valves immediately close, isolating the aircraft systems.
- The **ABORT** function should only be used as a last resort:
 - When a restart is required after the system has shutdown displaying an error message.
 - As an emergency measure.
- If the system is restarted by pressing **ABORT**, it vents to atmosphere during the power-up sequence. The aircraft systems remain at the original pressures. At a later stage in the power-up sequence, the aircraft system pressures are sampled and the Ps (static) and Pt (pitot) channels reconnected with a small pressure loss.

Main Menu

In the Leak Measure and Control modes the display shows and provides further selections.

[Rate Timer]

- The Rate Timer starts an internal timer for a pre-defined set of times. On the completion of the time period, the display shows the average rate of change over the time period.
- The pre-defined time period with an associated wait period allows pressures to settle before the timing starts. The wait period counts down to zero before the time period starts.

Rate timing

- Press **LEAK MEASURE/CONTROL** to select Leak Measure mode and, from the main menu, select [Rate Timer]. The display shows the default time of 1.00 minutes and a wait time of 1.00 minutes. Select each in turn and using the numeric keys change the time and rate time to the required values.
- Select [Start Timing] to begin the test. The display shows "Waiting: 0.00" at the bottom of the screen and counts down the waiting period. The display then changes to "Timing: 0.00" and counts down the timing period. After the timing period the ROC and RtCAS changes to Timed Leak Measure and shows the units/min leak rate.
- Pressing one of the parameter keys (e.g., ALT/Ps, ROC/RtPt, SPEEDQc etc.) or **QUIT/CLEAR** cancels the Timed Leak Measure display and returns to the Leak Measure display.
- At any time during rate timing or when a timed value is displayed, selecting [Rate Timer] allows for either the restarting or cancelling of the timing. When timing is cancelled, the rate displays returns to instantaneous values.
- The timed average value remains until a new aim is entered. During this time, it is possible to view any parameter.

[Units]

- The list of units shown in the main menu divide into aeronautical units and units of pressure measurement. The display shows the available units selected from the list in the set-up menu. Select the units and then press **CLEAR/QUIT**. The available units are:

Example

Aeronautical units:

- ft and kts (ft/min) (includes Mach)
- m and km/h (m/min) (includes Mach)

Units of pressure measurement:

mbar

Note: See set-up to change to another unit of pressure measurement.

Selecting [Units] F4, from the main menu, displays the three available sets of units as follows:

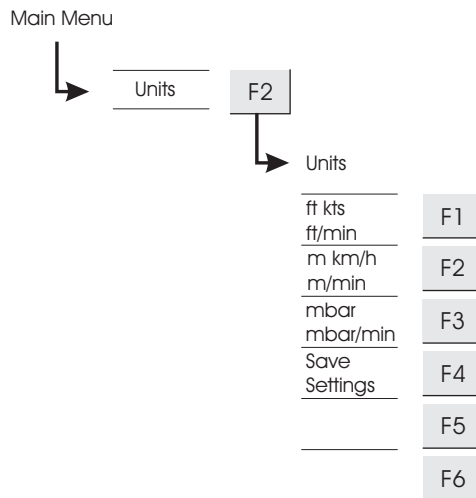

[EPR]

- Engine Pressure Ratio only operates in units of pressure measurement (mbar, inHg etc.) with a set of pre-defined limits, see section 1. The ADTS 505 can be used to check EPR sensors, indicators and EPR data for engine control systems.

Note: *Altitude correction applies to EPR values, make sure this correction does not adversely affect accuracy. The difference in height between the ADTS 505 and the EPR sensor may be different to the altitude correction previously set for the aircraft instruments.*

- For EPR testing, use Ps as INLET pressure and EPR to set the ratio of OUTLET pressure (Pt) to INLET pressure (Ps).
- Before entering a new EPR aim, the rate of change should be set by selecting [EPR Rate] on the Main Menu.
- When in Control Mode (AIM display), a new EPR aim can be entered using the numeric keys. Use **LEAK MEASURE/CONTROL** to change between Control and Leak Measure mode.

Rate EPR

- When in Control Mode (AIM display), the rate of pressure change can be set using the numeric keys. Use **LEAK MEASURE/CONTROL** to change between Control and Leak Measure mode.

[Hold]

- Selecting [HOLD] causes a changing pressure to instantaneously hold. Selecting [HOLD] again releases the pressure to continue to the aim value. The [HOLD] facility applies to both channels simultaneously.
- [HOLD] automatically releases when **LEAK MEASURE/CONTROL** is pressed entering Measure Mode.

[Nudge]

- Changes the current aim value [▲ or ▼] by a set increment value (2 ft, 0.2 kts, Mach 0.02).
- This facility can be used to align a pointer of an instrument to a precise indicated value and compare this indicated value with the measured value.
- This facility may be used for pressure switch testing as follows:
 - ❏ Aim for a pressure just below the expected operating point.
 - ❏ When the pressure is achieved, repeatedly press ▲ until the switch operates.
 - ❏ Record the pressure reading shown on the display.
- Repeat this procedure using the ▼ until the switch returns to its original condition, refer to section 3 for an example.

6.3 SETUP

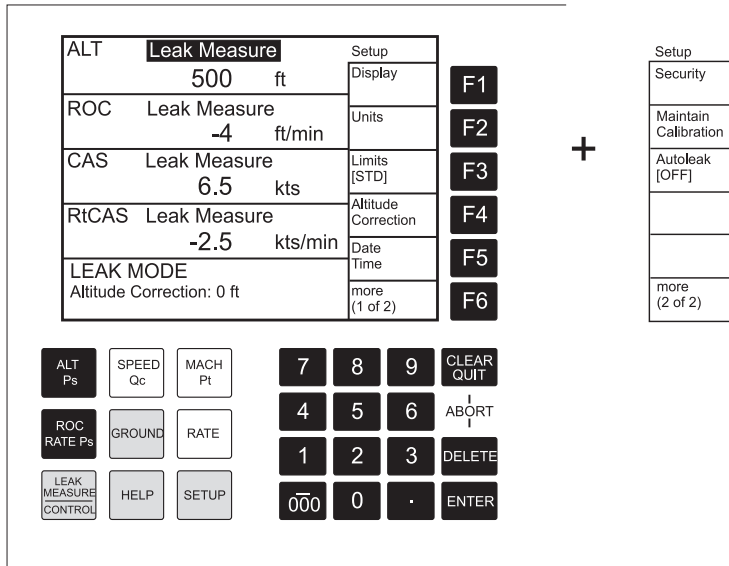

Set-up allows access to secondary functions that do not have an assigned key and are not part of the main menu.

6.3.1 Set-up 1 of 2

[Display], [Single, Dual, Quad, Hand Term]

In leak measure mode, after each parameter, the display shows "Leak Measure". In control mode the display changes to Aim = after each parameter.

- **Single**
The display shows a single parameter. When set, pressing a key-pad function key, the display changes the displayed parameter. The display will not change if **RATE** is pressed when **ROC/RtPs** is displayed.
- **Dual**
The display shows two parameters only one can be a rate. The display will not show RtCAS and ROC/RtPs together and automatically changes to show CAS or ALT respectively. The display highlights the last selected parameter.
- **Quad**
The display shows four parameters, pressing a key-pad function key, changes a displayed parameter and causes the display to highlight the last selected parameter.
- **Hand Term**
This option has two display settings, see paragraph 6.4 for details.

[Units]

- The list of units in the set-up menu divide into aeronautical units and units of pressure measurement. The available units are:

Aeronautical units

ft and kts (ft/min) (includes Mach)
 m and km/h (m/min) (includes Mach)
 m and mph (m/s) (includes Mach)
 m and km/h (hm/min) (includes Mach)

Units of pressure measurement

mbar	inH ₂ O 60°F
inHg	psi
mmHg	hPa
inH ₂ O 4°C	kPa
inH ₂ O 20°C	

Selecting [Units] from the main menu displays the three available sets of units, to change the available sets, press **SETUP** and select:

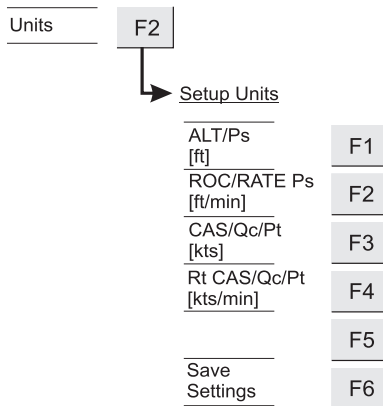
**[Setup units]**

Select a parameter to change (i.e., ALT/Ps), the current unit in [brackets].

The display shows units of altitude: ft or metres and pressure units. Similarly, selecting the other parameters causes the display to show appropriate units. After selecting the required units, select {Save Settings} and then repeatedly press **CLEAR/QUIT** to return to the main menu.

[Limits]

- The ADTS 505 is preprogrammed with the manufacturer's standard, civil and maximum limit sets (STD, CIVIL and MAX). This facility enables five sets of additional limits to be programmed and allows the selection of a set of limits to be used; each additional set of limits can be identified by its aircraft name or type.
- To access limit sets for editing values, select enter PIN and use [▲ or ▼] to step through the aircraft names highlighted in the display. After changing the limits, select [Save Settings] press **CLEAR/QUIT** to save and exit.

- Each set of limits contains:

(Page 1 of 2)	(Page 2 of 2)
Max ALT	Max Ps
Min ALT	Min Ps
Max CAS	Max Qc
Min CAS	Min Qc
Max Mach	Max Rate Ps
Max ROC	Max Rate Qc
Max Rate CAS	
ARINC limits on or off	
Altitude correction value	

- The selected set of limits remain active until the selection of another set of limits or until power supply switch-off. At each power-up sequence the default set of limits "CIVIL" become active. The "CIVIL" limit set contains the lowest ranges and values.
- If the selected set of limits results in the measured pressures being outside the limits, the display shows the warning message "Changed entry to current limit" the system automatically changes the aim value to within the selected limits. This warning message is also displayed if the pressures measured directly after power-up are outside the limits used at power-up.
- After selecting a set of limits, the altitude correction value can be changed using **SETUP**, [Altitude Correction], [Alt. Corr.]. The display shows the altitude correction (in ft or m) below the mode message.

New Limits

CAUTION: USING INCORRECT LIMITS CAN CAUSE DAMAGE TO SENSITIVE COMPONENTS AND AIRCRAFT SYSTEMS.

- Before creating new limits refer to the appropriate Component Maintenance Manual or Aircraft Maintenance Manual for the actual minimum and maximum values to be applied.
- A PIN protects access to the sets of limits that can be created, renamed or edited. Druck recommends that only personnel of supervisor level have access to these limit sets.

- After manufacture the ADTS 505 only contains the pre-defined limit sets. To create the first user-defined set, use the ▼ to step down the list. At the bottom of the list press ▼ again, select [Modify Name], F5 and using the seven screens of characters compose the name of the new limit set, press **ENTER**. Select [Modify Details], F4, set the units (aeronautical and pressure) to be used and, after each entry of a completed value, press **ENTER**.

ARINC Limits

- The ARINC 565 limit can be selected ON or OFF in a set of user defined limits. When selected, the values entered and/or achieved in control mode are checked within the operating envelope of the ARINC 565 limits.

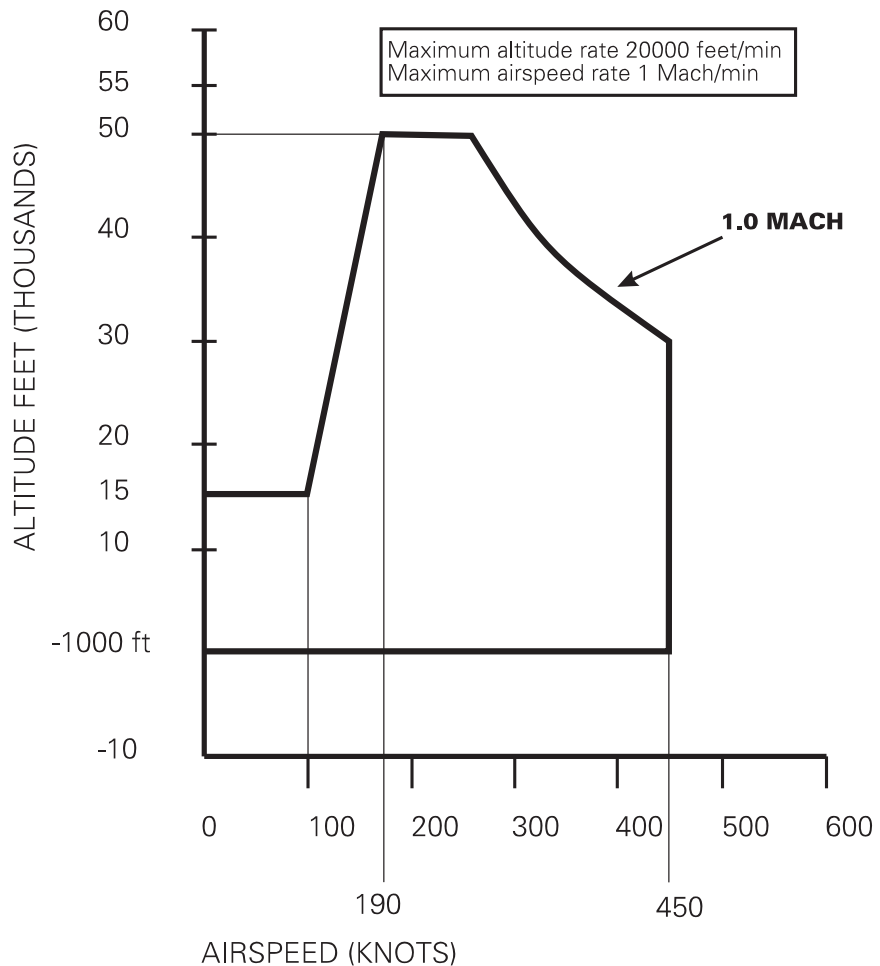

FIGURE 6-1 ARINC 565 LIMITS GRAPH

[Alt. Corr.]**Altitude Correction (Figures 6-2 and 6-3)**

- This function allows the altitude correction value to be changed. The display shows the altitude correction value in the lower part of the display screen.
- The altitude correction facility corrects for the pressure difference when the ADTS 505 and the aircraft system or UUT are at different heights.
- Enter the height difference between the aircraft system or UUT and the ADTS 505 reference level. If the ADTS 505 front panel is vertical, use a reference level of the mid point on the front panel. If the ADTS 505 front panel is horizontal, then use the reference level of the top of the case. If the aircraft system or UUT is below the ADTS 505, enter the value as a negative number.
- The units of altitude correction are the current aeronautical units.

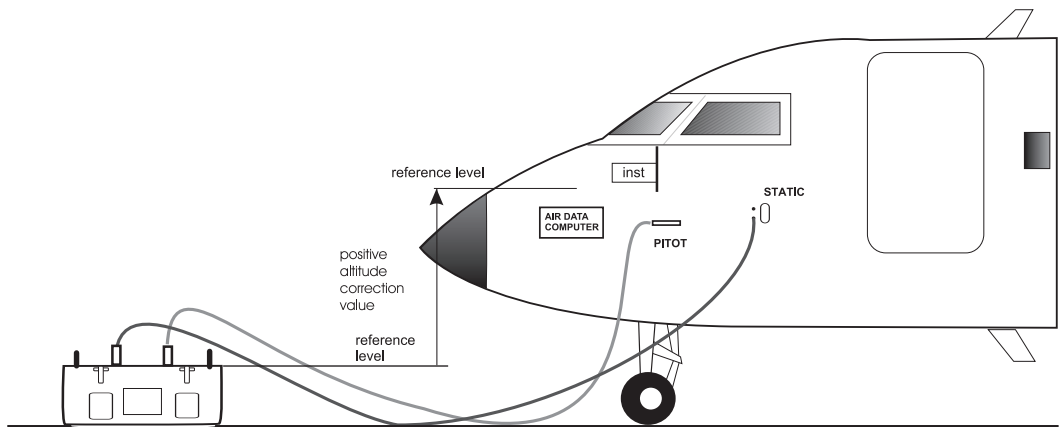

FIGURE 6-2 ALTITUDE CORRECTION ON-AIRCRAFT

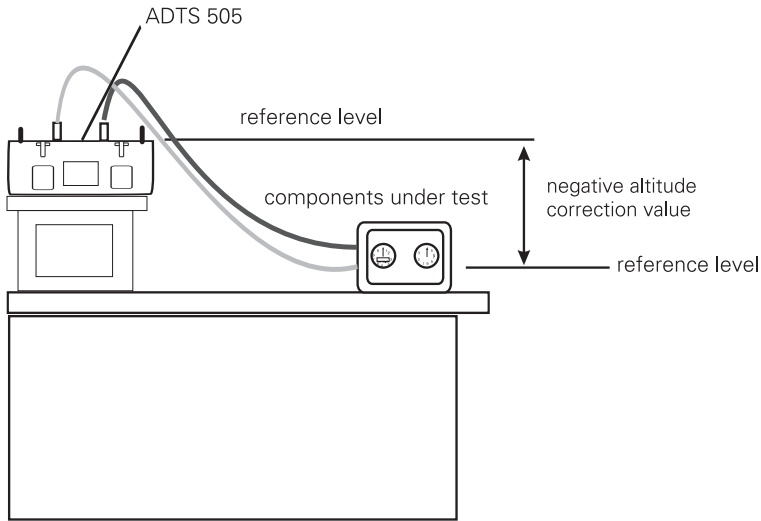
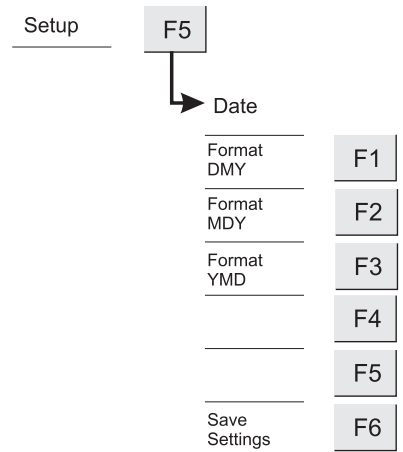

FIGURE 6-3 ALTITUDE CORRECTION OFF-AIRCRAFT

[Date Format]

The format of the date can be changed to satisfy local requirements.



6.3.2 Set-up 2 of 2

[Operational Hours]

- This display shows the total number of hours for system operation and the total number of hours of pump operation. The system records, as a background task, the total running hours of the unit. At an appropriate time before the 1000 and 3000 servicings are due a message is added to the power-up display sequence reminding the user of the hours to go before a servicing.

[Software Versions]

- This display shows the master software version reference for the product followed by the component versions used by the display and key-pad [LDK], the system controller and the optional hand terminal.

[Security]

- Two PIN codes (level 1 and 2) protect access into two sensitive settings menus. Level 1 allows access to the sets of operating limits. Level 2 allows access to the system calibration/characterisation menu. This security menu allows the code or number of digits to be changed. Both PIN code can be up to 10 digits. A single zero disables the PIN protection, allowing unrestricted access to the settings.

[Maintain Calibration]

[Test Keypad]

The display shows a schematic of the key-pad with indications of each key press. A test procedure for the key-pad test is detailed in section 5, Testing and Fault Finding.

[View Manifold]

The display shows a table of the current system data values with real time indications of the status of the valves and the transducers. This facility provides a method of performance assessment by showing actual system values which can be compared with the known system parameters. A fault finding procedure for the system is detailed in section 5, Testing and Fault Finding.

[Enter PIN]

After entering the correct level 2 PIN, this facility allows access for servicing technicians to characterise the valves or calibrate the pressure sensors through additional menus.

Setup (2 of 2)

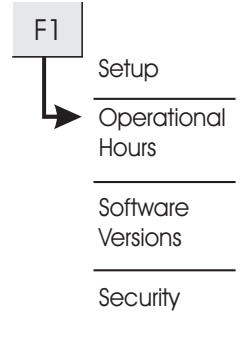

[View Manifold]

- ✘ This facility is the same as view manifold (above) but within the PIN protected area.

[Valve Calibration]

- ✘ The system operates the apply and release valves, measures performance, calculates and stores the characteristics of each valve. This takes approximately 20 minutes to complete.

Note: *To complete this set-up requires additional equipment and should only be carried out at approved equipment service centres.*

[Work Valves]

- ✘ Should a valve be replaced and, before valve calibration, the new valve requires exercising to bed into the valve seat. The recommended time for this function is 8 hours. Selecting this function operates each apply and release valves every second until Cancel Test is selected.

[Cancel Test]

- ✘ This stops the work valves function.

[Calibrate Sensors]

- ✘ The calibration function requires the calibration switch on the front panel to be enabled. This procedure must be carried out by a qualified calibration technician, the details of calibration are contained in the Druck Calibration Manual for the ADTS 505.

[Auto Leak]

- The ADTS 505 protects the aircraft system against leaks in the aircraft system. The system protection operates:
 - ✘ Automatically regains control if the leak rate is greater than the parameter rate (RtPt, ROC) during leak testing.

6.4 Other Features

Elapsed Time Counter

The system records, as a background task, the total running hours of the unit and the pump running hours. This facility assists with the scheduling of the 1000 hour and 3000 hour servicings.

Auto Zero

- This function optimizes airspeed accuracy at low airspeeds. The ADTS 505 performs an auto zero when the following conditions are met:
 1. The ADTS 505 is in Leak/Measure mode.
 2. Ps and Pt pressures are stable.
 3. The airspeed is less than 20 knots (or Qc equivalent).
- The auto zero starts five minutes after entering Leak/Measure mode providing conditions 2 and 3 are met and thereafter, every five minutes.
- The auto zero sequence can be interrupted at any time by entering a new command (key press).

Hand Terminal Option A

- The hand terminal option connects to the front panel through an 18 metre cable and connector. Both the hand terminal and front panel key-pad and display provide the same information. All selections that can be made by the front panel key-pad can be made by the hand terminal key-pad.
- The system auto-detects the hand terminal at power-up or when connected and automatically disables the front panel key-pad. The front panel display can be set to show the message "Remote Hand Terminal Operating" or to monitor mode showing the current values and modes selected by the hand terminal. In monitor mode the front panel display shows only these values and modes but no function key selections.
- To change between message and monitor selections go to set-up, display, F6 Hand Term [Monitor]. Press F6 to switch between [Monitor] and [Message].

Advanced Hand Terminal Option B

CAUTION:

DO NOT USE SHARP OBJECTS ON THE TOUCH SCREEN; USE THE STYLUS (SUPPLIED AND RECOMMENDED). A SHARP OBJECT WILL PERMANENTLY DAMAGE THE TOUCH SCREEN, IT CANNOT BE REPAIRED.

- The advanced hand terminal provides a Windows®-based, touch-sensitive colour screen to up-load and down-load user-defined test programs. When connected the system auto-detects the advanced hand terminal and disables the front panel key-pad. The front panel display shows "Remote Hand Terminal Operating" (message/monitor) or the current values and modes of the advanced hand terminal (monitor). The display (Figure 6-6) shows the main operation menu with selections for system set-up, test sequence file screen and manual control screen.

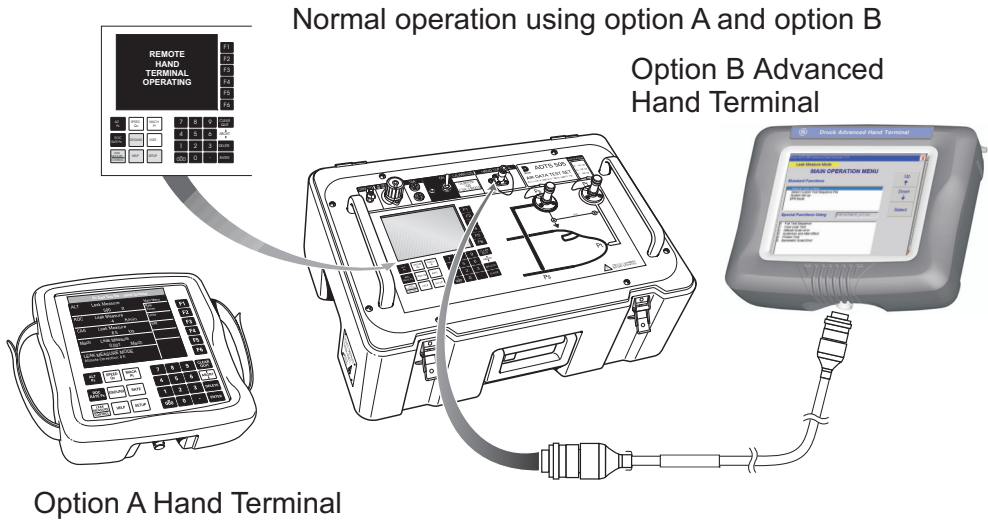

Uploading and downloading operations using the PC communications cable, power pack and power supply cable

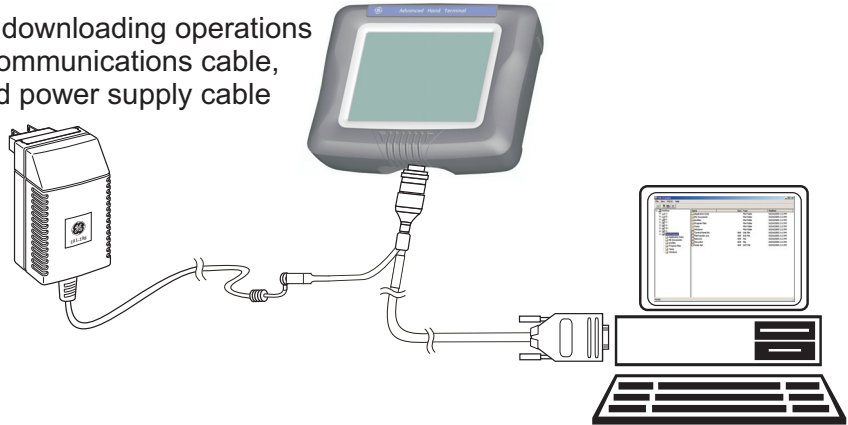

FIGURE 6-4 INTERCONNECTION

Power-up routine

- Set the power supply switch to ON.
- Check that the screen shows the correct display for a successful power-up.
Check:
 - ✘ the pump operates.
 - ✘ the power indicator lights
 - ✘ air discharges through the water drain.
- Connect the cable to the AHT communication connector on the ADTS 505.
- Check that the screen shows the correct display.
- Check that the ADTS 505 screens show the correct display messages.

Note: *This Windows-based facility hides many of the normal features of Windows.*

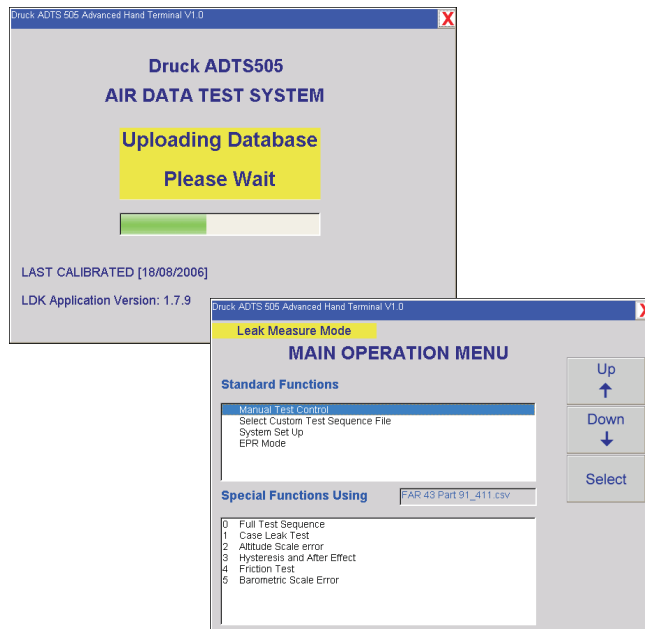

FIGURE 6-5 POWER-UP DISPLAYS

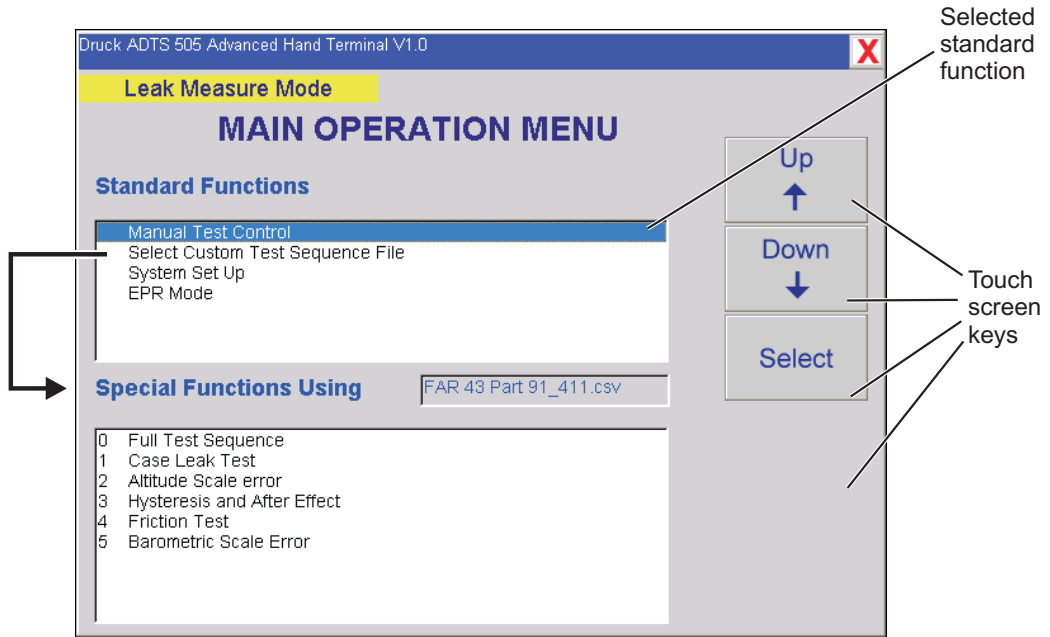

FIGURE 6-6 MAIN MENU SCREEN

Screen Displayed Key Selections

Touch screen key	Function and comments
UP/DOWN	Moves the screen highlight bar up/down.
Select	Selects the test or set of values highlighted by the up/down function.
Back	Returns to the previous screen.
Control	Switches all channels between measure and control modes.
Restore Default Values	Restores the last set of stored data values or unit selection saved as a default
Save Settings	Data Values or unit selection saved as a default.
Select	Activates the highlighted function.
Exit Program	Exits Program.
Enter	Confirms data entry to a numeric field.

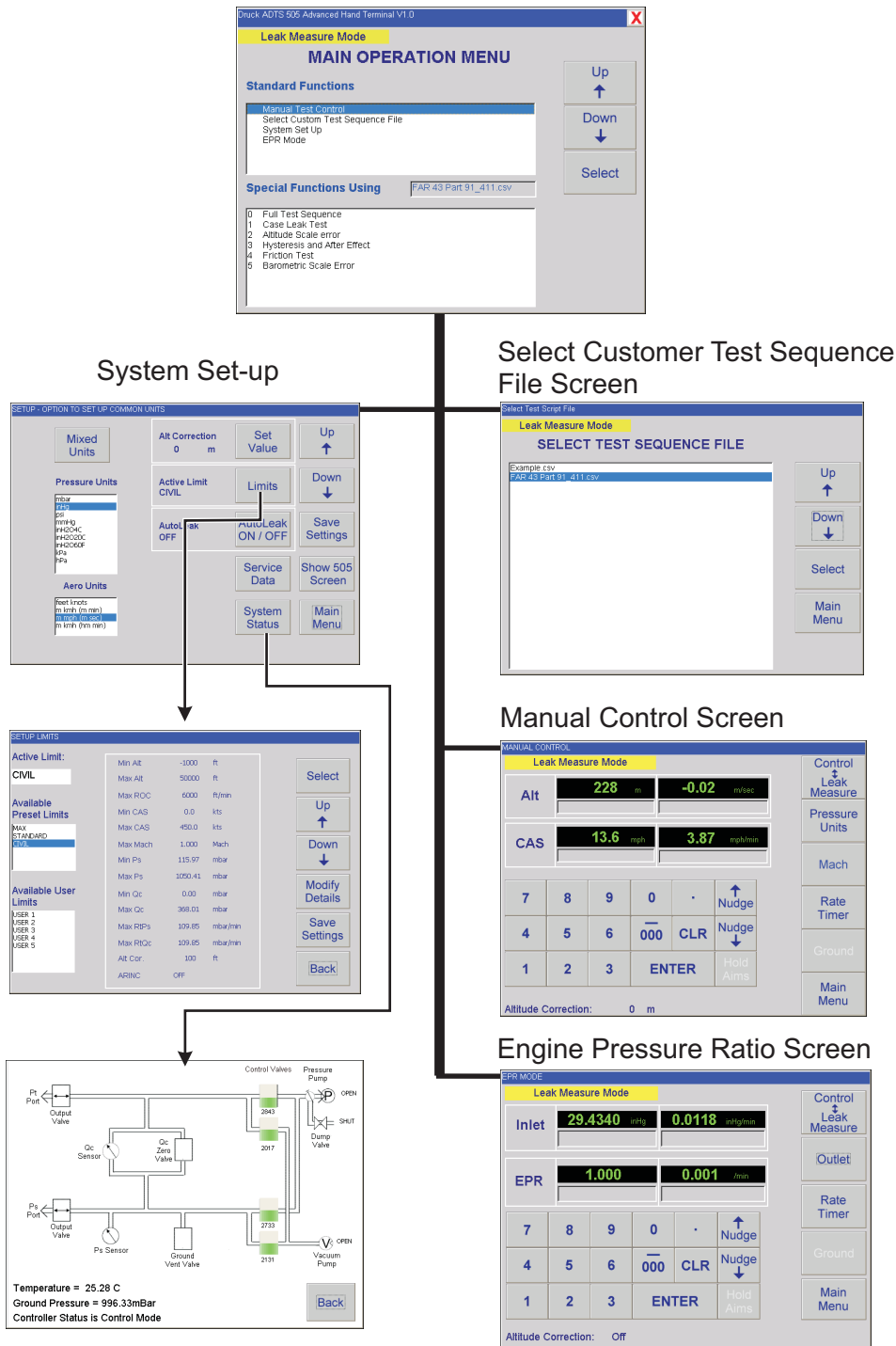

FIGURE 6-7 MAIN MENU STRUCTURE

Manual Mode

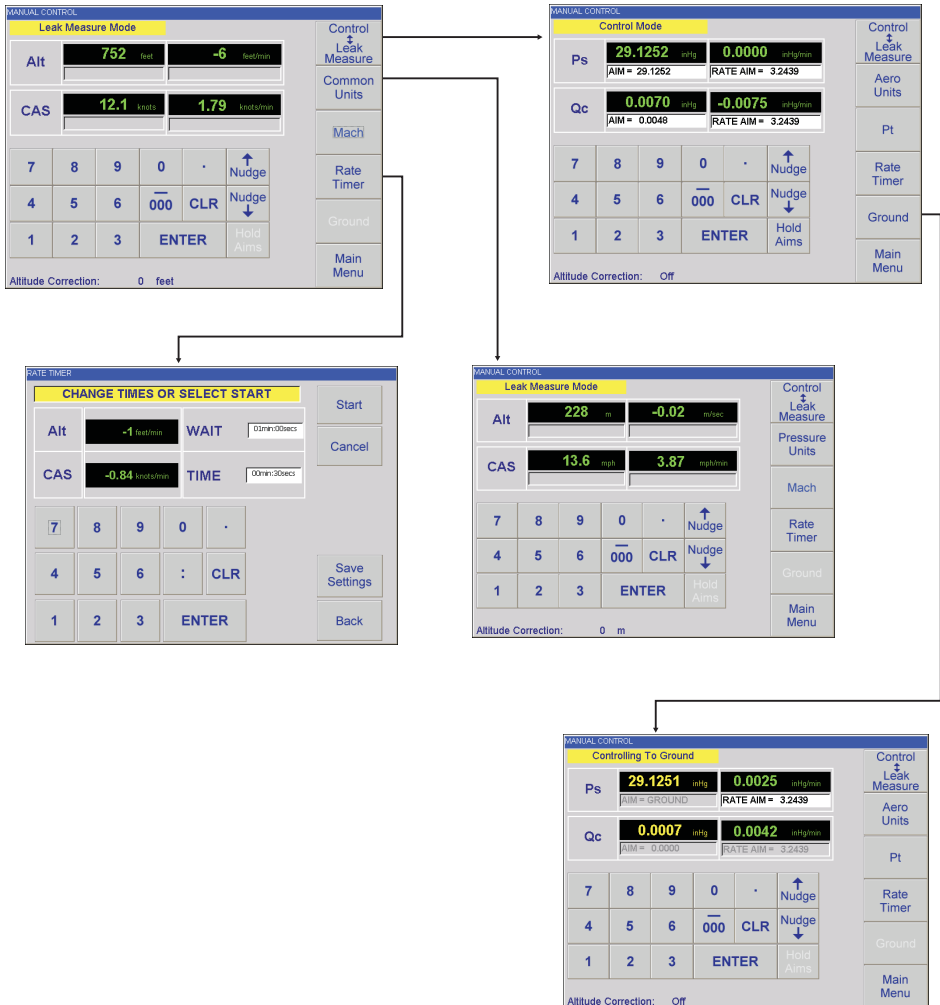
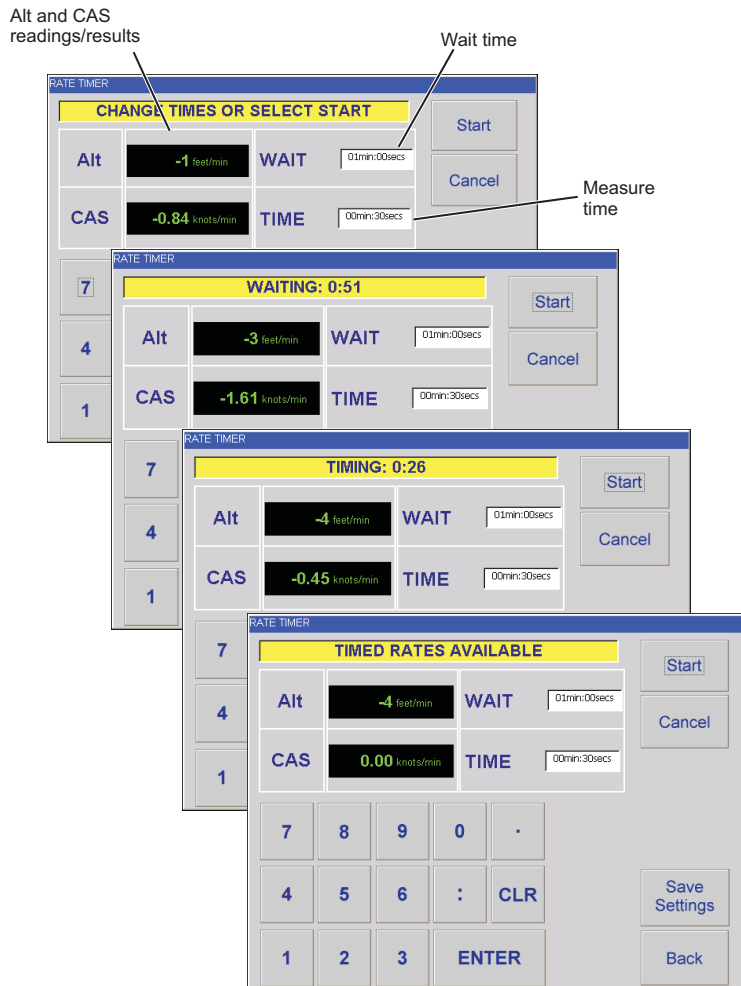

FIGURE 6-8 MANUAL CONTROL SELECTIONS

Selecting Control and Leak/Measure Modes

Manual test control always starts in leak measure mode displaying pressures in the last selected units of measurement. The system can be switched between aero units and pressure units, these units can only be changed in set-up mode.

Selecting control/leak measure switches between leak measure mode and control mode. In control mode the set of limits provide protection for the aircraft system and can only be changed in set-up mode.



EXAMPLE RATE TIMER SCREEN

Rate Timer

Selected in Leak/Measure Mode

1. Use the touch screen keys to select wait and measure times and use the numeric keys to enter the values.

Note: Times entered as whole numbers are interpreted as seconds. Numbers higher than 60 are interpreted and displayed as minutes and seconds (i.e. 90 = 1 minute 30 seconds = 1:30).

2. After selecting the timer values and with the required the Ps1, Ps2 and Pt readings, press the START key. The time counter shows the progress of the test: wait time, then test time. The results, at the end of the test, shows the timed rates for each channel indicated by "T" after the digits.
3. Press BACK to return to Leak Measure Mode.

The screenshot displays two main control panels. The top panel, titled 'MANUAL CONTROL', is in 'Controlling To Ground' mode. It shows two channels: Ps (29.1251 inHg, RATE AIM = 3.2439) and Qc (0.0007 inHg, RATE AIM = 3.2439). The bottom panel, titled 'Case Leak Test', is in 'At Ground' mode. It shows 'Alt 465 feet' and '-2 feet/min'. A large yellow dialog box titled 'At Ground Pressures' with an 'OK' button is overlaid on the screen. On the right side, a vertical menu contains buttons for 'Control Leak Measure', 'Aero Units', 'Pt', 'Rate Timer', 'Ground' (highlighted with an arrow), and 'Main Menu'. At the bottom of the 'At Ground' panel, there is a 'Requested Rate Per Minute' section with values 6000 and 300.0, and an 'Altitude Correction' of 0.0 feet.

Ground

Selected in Control Mode

1. Use the GROUND touch screen key to select go-to-ground. The displayed channel aims show GROUND, the controller takes all channels to ground pressures and Qc to zero as shown above.

Note: At any time during this operation, pressing Leak/Measure stops the operation.

2. The display shows At Ground Pressures (see above). Pressing "OK" cancels the yellow message box but leaves the system "At Ground". Pressing Leak/Measure returns the system to Leak/Measure mode.

Select Set-up

- From the main menu, select system set-up.

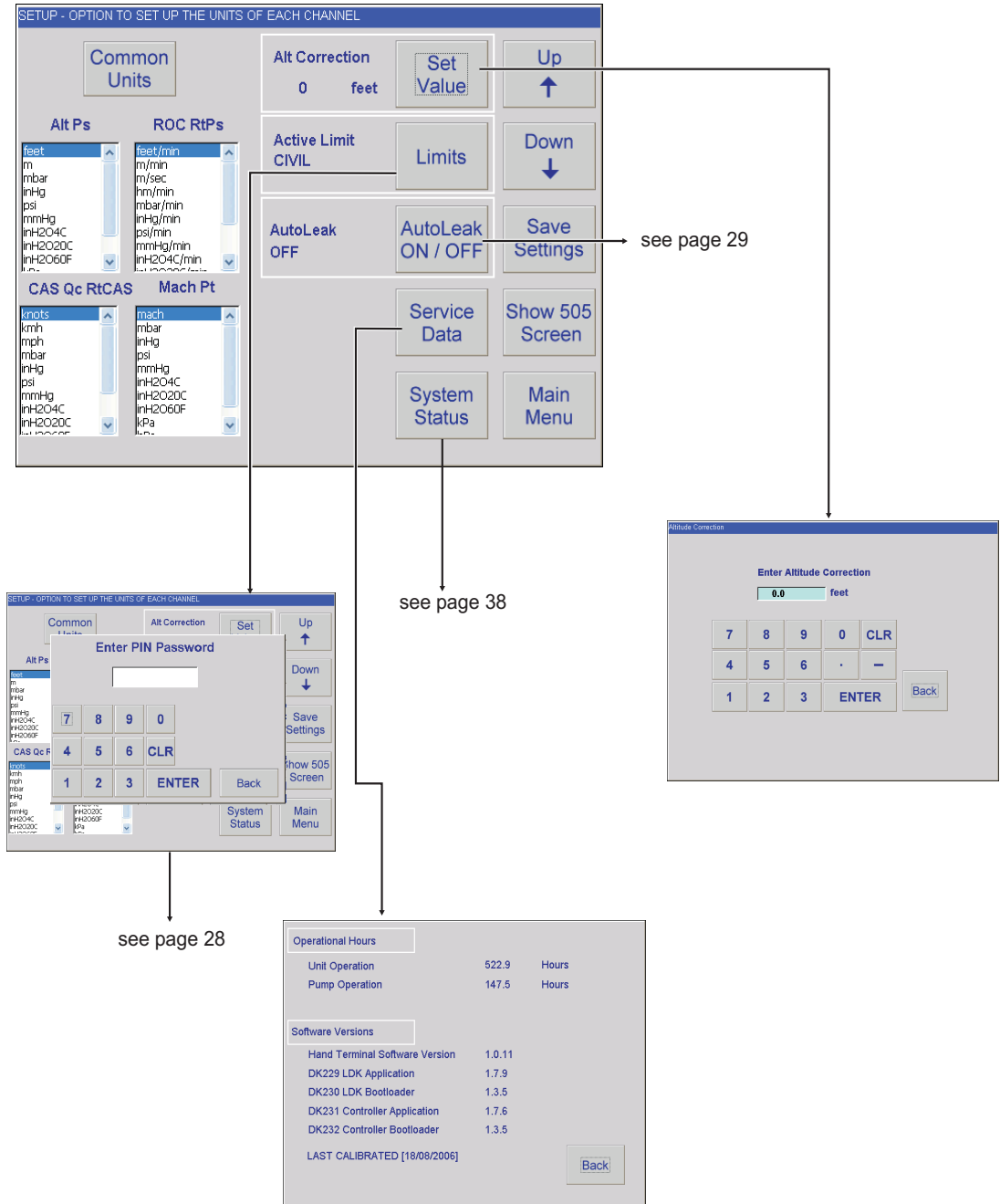

FIGURE 6-9 SET-UP MENU SELECTIONS

- Use the Up and Down keys to highlight the required aeronautical and pressure units.
- Press SAVE SETTINGS to store in non-volatile memory or press MAIN MENU to store in volatile memory and return to the Main Menu Screen. Press RESTORE DEFAULTS to restore the last set of stored values and unit selection saved as a default.

Select limits

Enter the PIN to access the SETUP LIMITS display. Select one of the preset limits of MAX, STANDARD and CIVIL or define and enable USER 1 limits. An eight character name/code can replace USER 1 title.

Default limits

This set of limits, identified as: CIVIL are enabled when the ADTS 505 is switched on:

MIN ALT	-1000 ft
MAX ALT	50,000 ft
MIN CAS	0.0 knots
MAX CAS	450 knots
MAX MACH	1.0 Mach
MAX ROC	6,000 ft/min
ARINC LIMITS	OFF
ALT CORRECTION	0 ft
MIN Ps	115.972 mbar (2.7 inHg)
MAX Ps	1050.406 mbar (38.1000 inHg)
MIN Qc	0.0 mbar
MAX Qc	368.01 mbar (10.8673 inHg)
MAX Rate Ps	109.85 mbar/min (10.8127 inHg/min)
MAX Rate Qc	109.85 mbar/min (10.8127 inHg/min)

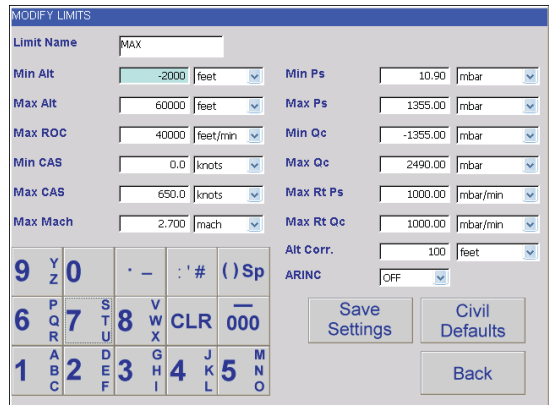
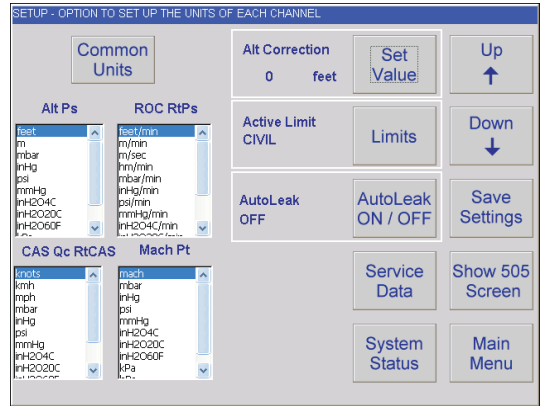

Altitude Correction

An altitude correction must be made to allow for the difference in height between the reference level of the ADTS 505 and the reference level of the aircraft's altitude sensors. Select the Instrument Altitude Correction and, using the numeric keys, enter the correction value (see Fig 2-2).

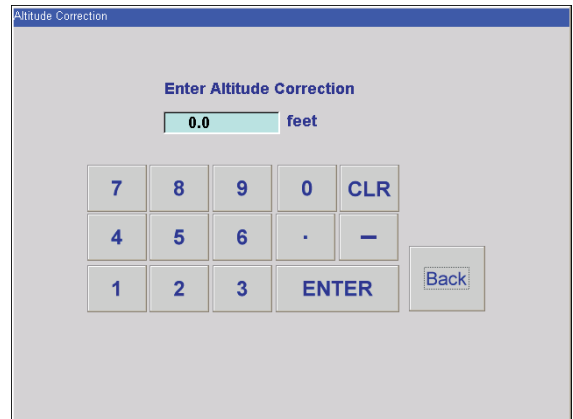

Altitude Correction

Enter Altitude Correction

0.0 feet

7 8 9 0 CLR

4 5 6 . -

1 2 3 ENTER Back

Auto leak

Auto leak automatically regains control if the leak rate becomes too high for any of the control channels. Auto leak operates at preset rates of 3000ft/min and 300knots/min. This facility can be switched off and on in set-up menu.

Select Test Sequence File

Files stored in the computer

1. From the main menu, select Custom Test Sequence File.
2. Use the Up and Down keys to highlight the test file.
3. Use the SELECT key to load the file.
4. Press MAIN MENU to return to the Main Menu Screen.

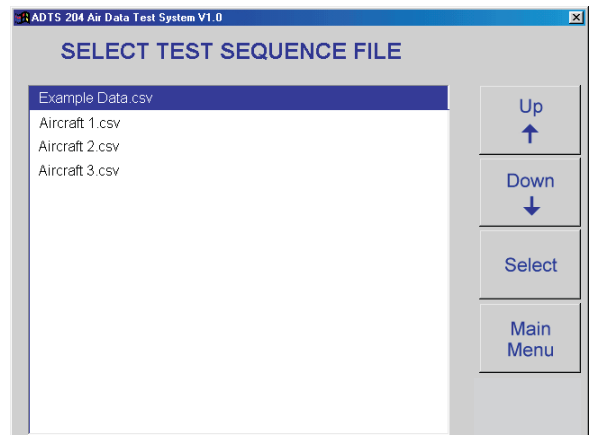

ADTS 204 Air Data Test System V1.0

SELECT TEST SEQUENCE FILE

Example Data.csv

Aircraft 1.csv

Aircraft 2.csv

Aircraft 3.csv

Up ↑

Down ↓

Select

Main Menu

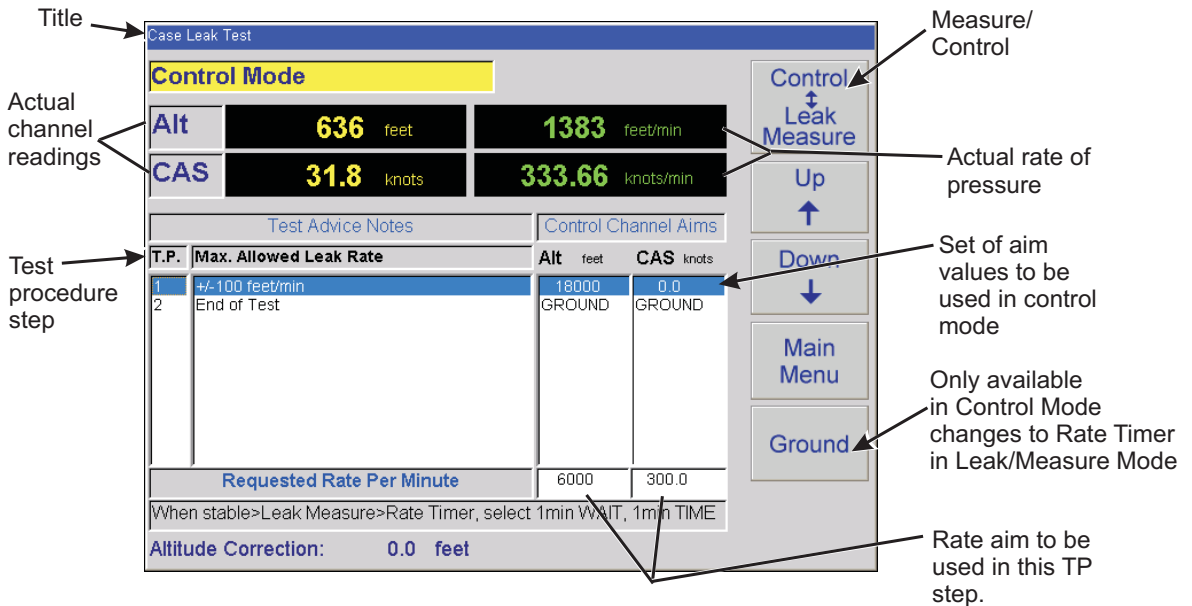

FIGURE 6-10 TEST SEQUENCE SELECTIONS

Selecting a Test Sequence

1. From the main menu, select the Custom Test Sequence File. The screen changes to the selected test screen with the data table from the file.
2. Use the touch screen keys to select each test procedure value.
3. After selecting the test procedure value use the **Control/Leak Measure** key to select CONTROL.
4. The screen changes to CONTROL MODE and shows the actual measurement and rate.

Creating Custom Test Sequences for the ADTS 505

Instructions for generating or editing source data for test table values

The data shown on each screen or table of the test sequence comes from a single data source file. This .CSV format file uses numeric data fields separated by commas. Files of this type may be viewed and edited using a spread sheet program such as Excel. Files would normally be saved with an applicable name for easy identification and selection.

A template file (TEMPLATE.CSV), provided on the software distribution with this product, may be used as the basis for creating new aircraft test sequences. An example, below, shows how the data fields of the file can be used in the test screens.

Annotations in the image:

- Test Table Title: Case Leak Test
- Header 2: Max. Allowed Leak Rate
- Header 1: T.P.
- Ref: 1, 2
- Test Descriptor: +/- 100 feet/min, End of Test
- Message: When stable>Leak Measure>Rate Timer, select 1min WAIT, 1min TIME
- Rate Units: feet, knots, feet/min, knots/min
- Aim Units: 18000, 0.0, GROUND, GROUND
- Ps, Pt Aims: 6000, 300.0
- Ps, Pt Rates: 0.0 feet

T.P.	Max. Allowed Leak Rate	Alt feet	CAS knots
1	+/- 100 feet/min	18000	0.0
2	End of Test	GROUND	GROUND

FIGURE 6-11 CUSTOMER TEST SEQUENCE FILE SELECTIONS

TEMPLATE FORMAT FOR CREATING TEST SEQUENCE FILES
 (files to be created using EXCEL and saved as <FILENAME.CSV> (comma separated variables))

Test Identifier	Parameter Label	Prompt Message	P s1 Aim	P s2 Aim	P t Aim	P s1 Rate	P s2 Rate	P t Rate
Begin Test Table								
<TEST TABLE TITLE 1>								
<HEADER 1>	<HEADER Z>		<AIM UNIT>	<AIM UNIT>	<AIM UNIT>	<RATE UNIT>	<RATE UNIT>	<RATE UNIT>
<REF (a)>	<TEST DESCRIPTOR (a)>	<MESSAGE (a)>	<P s1 Aim (a)>	<P s2 Aim (a)>	<P t Aim (a)>	<P s1 Rate (a)>	<P s2 Rate (a)>	<P t Rate (a)>
<REF (b)>	<TEST DESCRIPTOR (b)>	<MESSAGE (b)>	<P s1 Aim (b)>	<P s2 Aim (b)>	<P t Aim (b)>	<P s1 Rate (b)>	<P s2 Rate (b)>	<P t Rate (b)>
<REF (c)>	<TEST DESCRIPTOR (c)>	<MESSAGE (c)>	<P s1 Aim (c)>	<P s2 Aim (c)>	<P t Aim (c)>	<P s1 Rate (c)>	<P s2 Rate (c)>	<P t Rate (c)>
<REF (d)>	<TEST DESCRIPTOR (d)>	<MESSAGE (d)>	<P s1 Aim (d)>	<P s2 Aim (d)>	<P t Aim (d)>	<P s1 Rate (d)>	<P s2 Rate (d)>	<P t Rate (d)>
<REF (e)>	<TEST DESCRIPTOR (e)>	<MESSAGE (e)>	<P s1 Aim (e)>	<P s2 Aim (e)>	<P t Aim (e)>	<P s1 Rate (e)>	<P s2 Rate (e)>	<P t Rate (e)>
End Test Table								
Begin Test Table								
<TEST TABLE TITLE 2>	<HEADER Z>		<AIM UNIT>	<AIM UNIT>	<AIM UNIT>	<RATE UNIT>	<RATE UNIT>	<RATE UNIT>
<REF (a)>	<TEST DESCRIPTOR (a)>	<MESSAGE (a)>	<P s1 Aim (a)>	<P s2 Aim (a)>	<P t Aim (a)>	<P s1 Rate (a)>	<P s2 Rate (a)>	<P t Rate (a)>
<REF (b)>	<TEST DESCRIPTOR (b)>	<MESSAGE (b)>	<P s1 Aim (b)>	<P s2 Aim (b)>	<P t Aim (b)>	<P s1 Rate (b)>	<P s2 Rate (b)>	<P t Rate (b)>
<REF (c)>	<TEST DESCRIPTOR (c)>	<MESSAGE (c)>	<P s1 Aim (c)>	<P s2 Aim (c)>	<P t Aim (c)>	<P s1 Rate (c)>	<P s2 Rate (c)>	<P t Rate (c)>
<REF (d)>	<TEST DESCRIPTOR (d)>	<MESSAGE (d)>	<P s1 Aim (d)>	<P s2 Aim (d)>	<P t Aim (d)>	<P s1 Rate (d)>	<P s2 Rate (d)>	<P t Rate (d)>
<REF (e)>	<TEST DESCRIPTOR (e)>	<MESSAGE (e)>	<P s1 Aim (e)>	<P s2 Aim (e)>	<P t Aim (e)>	<P s1 Rate (e)>	<P s2 Rate (e)>	<P t Rate (e)>
End Test Table								

Field Descriptions

- **Begin Test Table**
- **End Test Table**
- <TEST TABLE TITLE n>
- <HEADER 1>
- <HEADER 2>
- <AIM UNIT>
- <RATE UNIT>
- <REF (a) to (e)>
- <TEST DESCRIPTOR (a)>
- <MESSAGE (a)>
- <P s1 Aim (a) to (e)>
- <P (s1)Rate(a) to (e)>
- <P (s2)Aim(a) to (e)>
- <P (s2)Rate(a) to (e)>
- Control keywords - delimits the start of a test table data set.
- Control keywords - delimits the end of a test table data set.
- Free text field (34 characters maximum) - title for a page of test aims.
- Free text field column title (3 characters maximum).
- Free text field (29 characters maximum) - describes test.
- Control field - sets the units for entry of channel pressure aims, pressure or aeronautical, as per the units screen.
- Control field - sets the units for entry of channel pressure rates, pressure or aeronautical, as per the units screen.
- Free text field per test row (3 characters maximum) - refers to a section of a test document etc.
- Free text field per test row (29 characters maximum) - describes test conditions at that point etc.
- Free text field per test row (70 characters maximum) - gives instructions to the user etc.
- Numeric entry fields (3 per test row) - must contain a pressure aim for each channel in units <AIM UNIT>.
- Numeric entry fields (3 per test row) - must contain a pressure rate for each channel in units <RATE UNIT>.
- Not used on the ADTS 505 - must contain a pressure aim of 0 (zero)* <AIM UNIT>.
- Not used on the ADTS 505 - must contain a pressure rate of 0 (zero)* <RATE UNIT>.

Notes: The example template file (.XLS, format, with coloured fields as above) may be used for creation, edit or archive of new test sequence files. A copy of the data sheet MUST be saved in .CSV file format for direct use by the ADTS 505 user interface program (.CSV files do not use the colour and column width of the .XLS). When necessary use ' and ' (single quotes) in free text fields. Do not use " " (double quotes) this causes program lock-up.
 * Alternatively, copy values entered for Ps1

Example Test Table

	Test Identifier	Parameter Label	Prompt Message
Begin Test Table			
<TEST TABLE TITLE >			
	<HEADER 1 >	<HEADER 2 >	
	REF (a)	<TEST DESCRIPTOR (a) >	<MESSAGE (a) >

	Test Identifier	Parameter Label	Prompt Message
Begin Test Table			
Case Leak Test			
	TP	Max. Allowed Leak Rate	
	1	+/- 100 feet/min	When stable> Leak Measure>
	2	End of Test	Go to ground

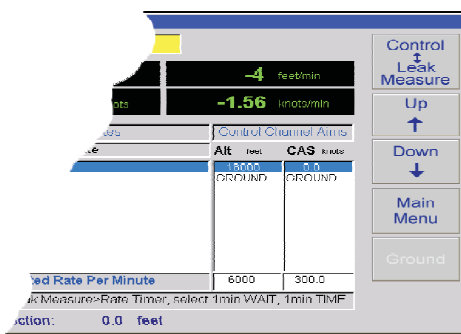
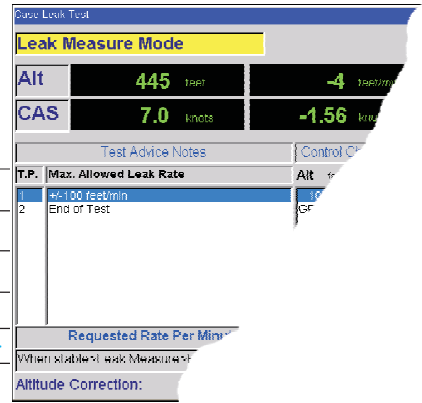

	Ps1 Aim	Ps2 Aim	Pt Aim	Ps1 Rate	Ps2 Rate	Pt Rate
	<AIM UNIT>	<AIM UNIT>	<AIM UNIT>	<RATE UNIT>	<RATE UNIT>	<RATE UNIT>
	<Ps1 Aim (a)>	<Ps2 Aim (a)>	<Pt Aim (a)>	<Ps1 Rate (a)>	<Ps2 Rate (a)>	<Pt Rate (a)>
	<Ps1 Aim (b)>	<Ps2 Aim (b)>	<Pt Aim (b)>	<Ps1 Rate (b)>	<Ps2 Rate (b)>	<Pt Rate (b)>
	<Ps1 Aim (c)>	<Ps2 Aim (c)>	<Pt Aim (c)>	<Ps1 Rate (c)>	<Ps2 Rate (c)>	<Pt Rate (c)>
	<Ps1 Aim (d)>	<Ps2 Aim (d)>	<Pt Aim (d)>	<Ps1 Rate (d)>	<Ps2 Rate (d)>	<Pt Rate (d)>
	<Ps1 Aim (e)>	<Ps2 Aim (e)>	<Pt Aim (e)>	<Ps1 Rate (e)>	<Ps2 Rate (e)>	<Pt Rate (e)>

	Ps1 Aim	Ps2 Aim	Pt Aim	Ps1 Rate	Ps2 Rate	Pt Rate
	feet	feet	knots	feet/min	feet/min	knots/min
	18000	0	0	6000	0	300
	0	0	0	6000	0	300

Pressure Units (for Ps, Pt, Qc)	Assumed Rates for Pressure Units
mbar	mbar/min
inHg	inHg/min
psi	psi/min
mmHg	mmHg/min
inH2O4C	inH2O4C/min
inH2O20C	inH2O20C/min
InH2O60F	inH2O60F/min
kPa	kPa/min
hPa	hPa/min

Aero Units (for Altitude and Speed)	Matching Rate of Aero Units
For Altitude:	
feet	feet/min
m	m/min
For Speed:	
knots	knots/min
kph	kph/min
mph	mph/min
Mach	knots/min

Aero Units for Altitude	Matching Speed Units
feet	knots
feet	mph
m	kph
Any of the above	Mach

Note: The pressure and aero units shown have been validated for these procedures. Using any other units in an up-loaded file may not be accepted by the advanced hand terminal.

*File Transfer Flowchart***File transfer**

**Transferring <NEW AIRCRAFT.CSV> files from a PC to:
the ADTS 505 Advanced Hand Terminal or ADTS 505**



New .csv file test scripts can be tested for general syntax and screen formatting using the desktop PC utility “ADTS 505 Remote” (DK250). This utility requires no external equipment connections to operate, available for installation from the distributor.

Transferring Files using GE FileTransfer Utility

CAUTION: DO NOT CONNECT THE POWER PACK (Table 2-1, item 6) TO THE PC COMMUNICATIONS CABLE (Table 2-1, item 5) WHEN IT IS CONNECTED BETWEEN THE ADTS 505 AND PC.

Connect the PC communications cable (Table 2-1, item 5) into an available 9-way ‘D’ COM port on the PC and the connector of the Advanced Hand Terminal.

Use the icon on the windows CE desk top to start the File Transfer Utility.

To start the File Transfer Utility on the PC, double click the  icon, set the File Transfer Utility, click the  to expand the Advanced Hand Terminal drive as shown:

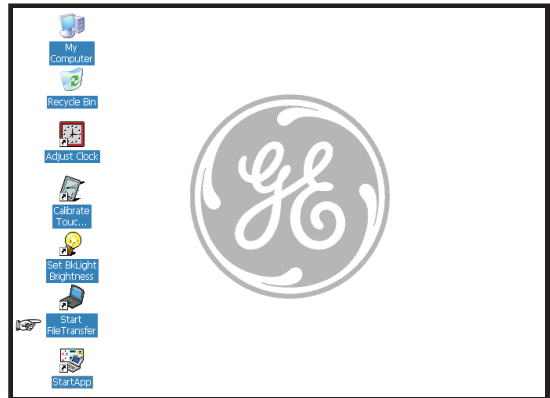

Name	Size	Type	Modified
Application Data		File Folder	03/24/2005 2:12 PM
My Documents		File Folder	03/24/2005 2:12 PM
profiles		File Folder	03/24/2005 2:12 PM
Program Files		File Folder	03/24/2005 2:12 PM
Temp		File Folder	03/24/2005 2:12 PM
Windows		File Folder	03/24/2005 2:12 PM
Control Panel.lnk	OKB	LNK File	03/24/2005 2:12 PM
FileTransfer.exe	OKB	EXE File	03/24/2005 2:12 PM
Network	OKB	File	03/24/2005 2:12 PM
Recycled	OKB	File	03/24/2005 2:12 PM
temp.dat	OKB	DAT File	03/24/2005 2:12 PM

Notes:

1. Check which serial communications has been connected, use the RS232 drop-down menu to set the PC communications port (COM1 to COM 4). The system stores this setting and automatically selects this port on the next power-up.
2. Only files directly loaded to the AHT will be accessible in the AHT menus. To be accessible from the ADTS 505 the files must be also loaded in the ADTS 505. This requires a different connection configuration see Figure 6-4.

To copy a new script file (.csv file) to the Advanced Hand Terminal click-on and highlight the required file and, using the File/Copy/Paste facility in Windows®, click on the Hand terminal/Hard Disk directory as the destination of the file. A progress bar appears and shows the transfer progress. Use the same procedure to transfer files from the Advanced Hand Terminal to the PC. After re-starting the main ADTS 505 application, the new test file can be selected and used.

File Transfer Utility NO Connection

An egg-timer icon ⌚ appears on the screen when the program detects a no connection condition. After approximately 20 seconds this file transfer error message appears.

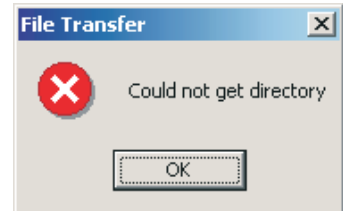

Software Settings

Refer to 2.7 for the list of software supplied with the ADTS 505ADTS 505. The following details the adjustments that can be made using this software

DK285 – RTC Adjuster

This program enables the adjustment of the system clock in Windows ® and the real-time clock on the control computer board. To execute this application, exit from the ADTS 505 program and double click on the icon Adjust Clock . The screen capture below shows the application running.

To adjust the date and time, use the window boxes provided on the left of the dialogue box. Click on the year number, the display shows up/down arrows to change the year shown below. When the date and time are correct, click the **Set Date And Time** button.

On completion, click the **Exit** button.

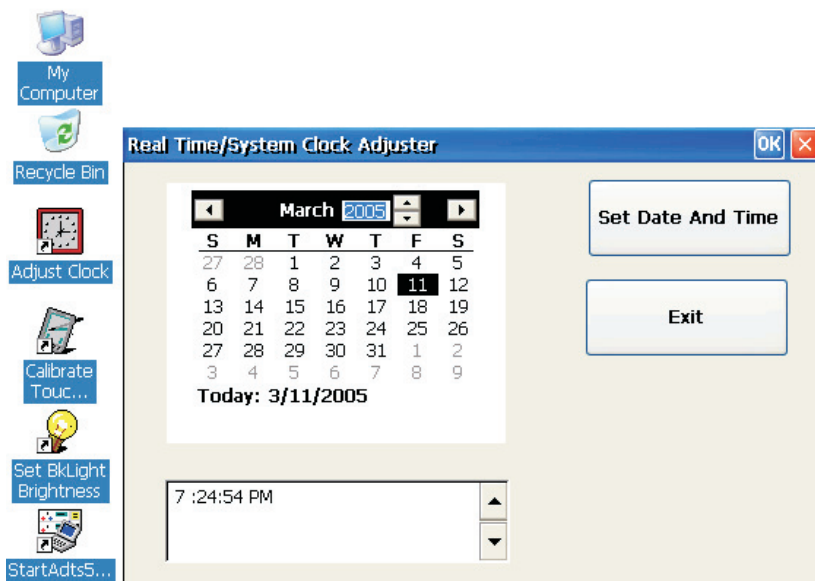

DK286 – Touch Screen Calibrator

This program enables the calibration of the touch screen. To execute this application, exit from the ADTS 505 program and double click on the Calibrate Touch icon . The Stylus application, stored as part of the system application, executes first. Select the calibration option and click the **Recalibrate** button. Follow the on-screen instructions, after obtaining all the calibration points, touch the screen once and the Stylus program returns to the previous screen. Close down the Stylus application, the screen shows the following:

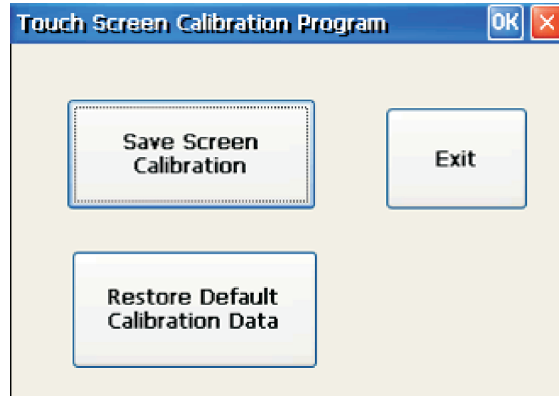

This screen gives the opportunity to save the calibration by clicking the **Save Screen Calibration** button, or restoring the default screen calibration stored by clicking the **Restore Default Calibration Data** button. The system stores the calibration data. On completion, click the **Exit** button.

DK287 – Display Backlight Brightness Setting Program

This program enables the user to adjust the brightness of the display back-light. To execute this program, exit the ADTS205 program and double click on the icon Set BkLight Brightness . The screen shows the following:

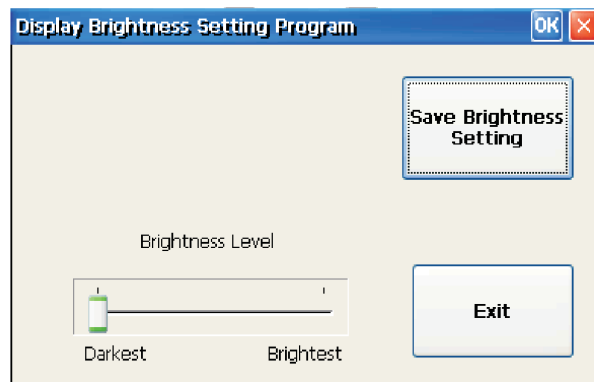

The slide bar Brightness Level starts in the position of the current back-light brightness. Adjust the brightness level by moving the slide bar left for darker and right for brighter. The back-light changes as the slide bar moves. To save the setting, click the **Save Brightness Setting** button, this stores the current brightness setting. On completion, click the **Exit** button.

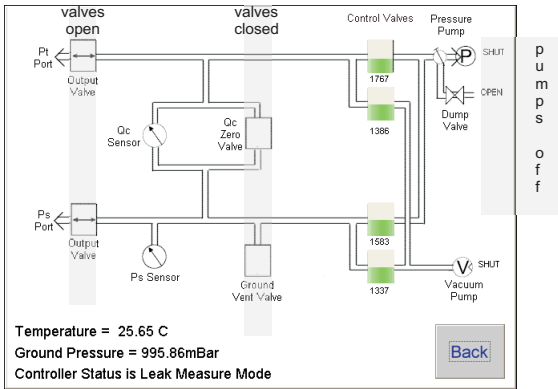
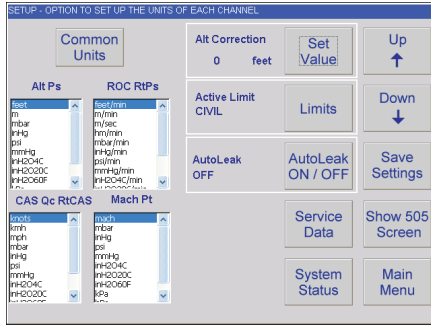

Leak Measure Mode

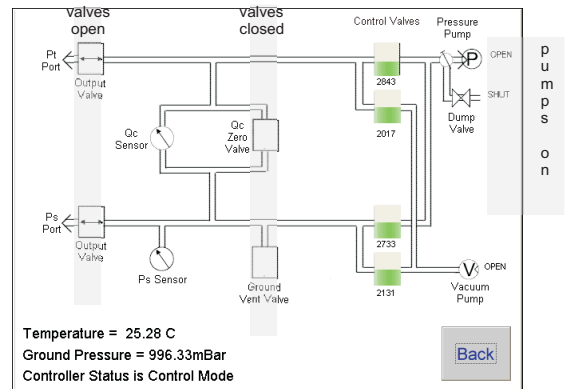

Control Mode

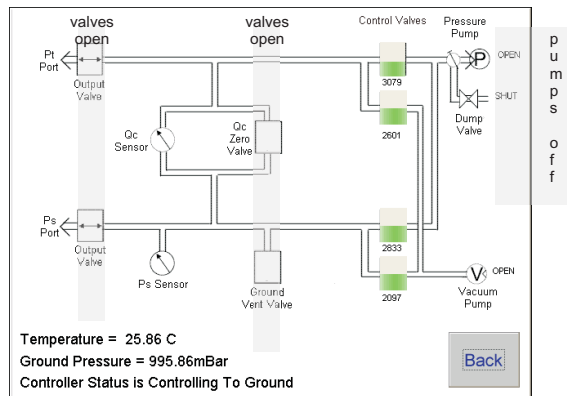

At ground

FIGURE 6-12 SYSTEM STATUS

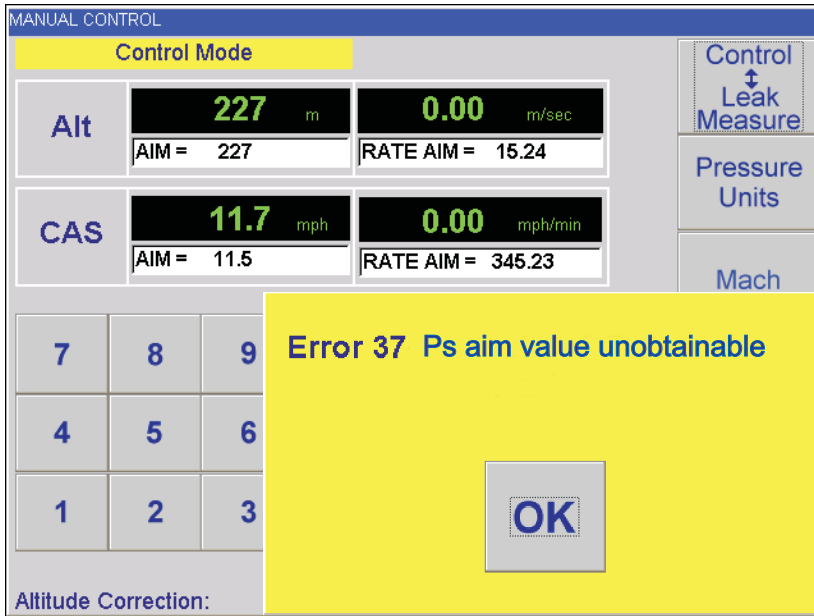

FIGURE 6-13 EXAMPLE ERROR SCREEN

Option B Advanced Hand Terminal Specification

Physical

Size	212 x 178 x 63 mm (8.35" x 7" x 2.48")
Weight	2.0 kg [4.4 lb.]

Conformity BSEN61010, BSEN61326-1, 97/23/EC

EMC	BS EN 61326 (Class A)
Electrical safety	BSEN61010
Pressure safety	Pressure Equipment Directive - class: sound engineering practice (SEP)
Vibration	MIL-T-28800 Class 2
Shock	Mechanical shock conforms to EN61010
CE marked	refer to page ii
ATEX approval	refer to page xii
Zone 2 definition	refer to page 6-40

Environmental conditions

For indoor and outdoor use	
Operating temperature	0°C to 50°C (32°F to 122°F)
Storage and shipping temperature	-25°C to 70°C (-13°F to 158°F)
Operating humidity	0 to 90% RH (non-condensing)
Vibration	MIL-PRF-28800 Type 2 class 5 style E/F
Power Supply	6.5 to 28V dc Power 16 VA
Installation	Class 2

6.5 Specification

Physical Specification

Size	265 mm x 520 mm x 355 mm (10.4" x 20.5" x 14")
Weight	15 kg [33 lb]

Conformity

EMC	EN 61326 (refer to the declaration of conformity for details)
Electrical safety	EN61010-1
Pressure safety	Pressure Equipment Directive - class: sound engineering practice (SEP)
Shock and vibration	MIL-T-28800 Class 2

Environmental conditions

For indoor and outdoor use	
Operating altitude	Up to 2,290 metres (7,500ft)
Operating temperature	0°C to 50°C (32° to 122°F)
Storage and shipping temperature	-20°C to 70°C (-4° to 158°F)
Calibrated temperature range	+5° to +35°C (+41° to +95°F)
Operating humidity	0 to 90% RH (non-condensing)
Vibration	MIL-PRF-28800 Type 2 class 5 style E/F
Power Supply	Auto-selection between: ➤ 100/120/230 Vac, 50/60 Hz Power - 200 VA ➤ 115 Vac, 400 Hz Power - 200 VA Transient over-voltages up to the levels of Overvoltage Category II
Pollution degree	2

Pressure/Vacuum Requirements

Pressure connections

Ps AN-4, 37° flare
 Pt..... AN-4, 37° flare

Performance

The ADTS 505 at a control set-point operating into a leak tight system, consumes no air. The integral pump is capable of the following:

Rate of climb6,000 ft/min into 4 litre (240 cu.in) to 30,000 ft
 Rate of speed300 knots/min into 2 litre (120 cu.in) to 650 knots

Note: These rates of change decrease for larger volumes.

Measurement and Control Range Specifications

Operating Range and Performance

Limits are set pre-defined tabular limits known as ARINC 565, CIVIL and EPR these can be selected through the SETUP menu. Operators may also configure the display to aeronautical or pressure units but should be aware that when units of pressure are selected, wider full-scale pressure limits will be enabled for some parameters.

Performance expressed in aeronautical units

	Altitude	Rate of Climb (ROC)	Calibrated Airspeed	Mach
Units	feet	ft/min	knots	-
Operating Range ⁽¹⁾	-2000 to 60,000 ⁽³⁾	0 to 40,000	20 to 650	0.16 to 2.8
Measurement	up to 105,000	0 to 40,000	0 to 1000	10
Accuracy ⁽²⁾	±3 at sea level ±7 at 30,000 ±29 at 60,000	±2% of value	±0.5kts at 50kts ±0.5kts at 550kts	Better than 0.005
Repeatability	±1 at sea level ±2 at 30,000 ±7 at 60,000	±0.5% (measurement)	±0.4kts at 50kts ±0.02kts at 550kts	0.001 rising to 0.005
Resolution	1	1	0.1	0.001

NOTES

- (1) Maximum operating range that can be achieved using the internal pump at airfield altitudes to a maximum of 7,500 ft above sea level.
- (2) Accuracy at ambient +5° to +35°C.
- (3) Not all combinations are available to prevent excessive Mach number. For the Mach number 2.8 limit to be maintained:

Altitude of 60,000 ft means a CAS limit of 590.2 knots.

Airspeed of 650 knots means a limit of 55,147 ft.

Performance expressed in pressure units

	Altitude Sensor (Ps)		Airspeed Sensor (Qc)		EPR
	mbar abs	inHg abs	mbar diff	inHg diff	
Units					-
Maximum Range ⁽¹⁾	71.7 ⁽³⁾ to 1355	2.1 to 40	-950 to +2490	1 to 73.53	0.1 to 10
Accuracy ⁽²⁾	±0.1	±0.003	±0.1% reading ±0.125 mbar	±0.1% reading ±0.0037 inHg	Better than 0.005
Repeatability	±0.05	±0.0015	±0.05 rising to 0.17	±0.0015 rising to 0.0051	-
Resolution	0.01	0.0003	0.01	0.0003	0.001

NOTES

- (1) Maximum operating range can be achieved using the internal pump at airfield altitudes to a maximum of 7,500 ft above sea level.*
- (2) The accuracy figures stated include 12 months stability.*
- (3) The system measures below this value but, because of pump capacity, controls to 71.7 mbar absolute. 35 mbar is the lowest calibration point.*

Max Pt 3000 mbar absolute (with Ps ≥500 mbar absolute)

Max Qc 2500 mbar differential (with Ps ≤500 mbar absolute)

Intentionally left blank