

Nokia E60 User Guide

DECLARATION OF CONFORMITY



We, NOKIA CORPORATION declare under our sole responsibility that the product RM-49 is in conformity with the provisions of the following Council Directive: 1999/5/EC. A copy of the Declaration of Conformity can be found from www.nokia.com/phones/declaration_of_conformity/.



The crossed-out wheeled bin means that within the European Union the product must be taken to separate collection at the product end-of-life. This applies to your device but also to any enhancements marked with this symbol. Do not dispose of these products as unsorted municipal waste.

Copyright © 2006 Nokia. All rights reserved.

Reproduction, transfer, distribution or storage of part or all of the contents in this document in any form without the prior written permission of Nokia is prohibited.

Nokia, Nokia Connecting People, Xpress-on and Pop-Port are trademarks or registered trademarks of Nokia Corporation. Other product and company names mentioned herein may be trademarks or tradenames of their respective owners.

Nokia tune is a sound mark of Nokia Corporation.



This product includes software licensed from Symbian Software Ltd (c) 1998-2004. Symbian and Symbian OS are trademarks of Symbian Ltd. US Patent No 5818437 and other pending patents. T9 text input software Copyright (C) 1997-2004. Tegic Communications, Inc. All rights reserved.



Includes RSA BSAFE cryptographic or security protocol software from RSA Security.



Java

POWERED Java and all Java-based marks are trademarks or registered trademarks of Sun Microsystems, Inc.

This product is licensed under the MPEG-4 Visual Patent Portfolio License (i) for personal and noncommercial use in connection with information which has been encoded in compliance with the MPEG-4 Visual Standard by a consumer engaged in a personal and noncommercial activity and (ii) for use in connection with MPEG-4 video provided by a licensed video provider. No license is granted or shall be implied for any other use. Additional information, including that related to promotional, internal, and commercial uses, may be obtained from MPEG LA, LLC. See <http://www.mpegla.com>.

Nokia operates a policy of ongoing development. Nokia reserves the right to make changes and improvements to any of the products described in this document without prior notice.

Under no circumstances shall Nokia be responsible for any loss of data or income or any special, incidental, consequential or indirect damages howsoever caused.

The contents of this document are provided "as is". Except as required by applicable law, no warranties of any kind, either express or implied, including, but not limited to, the implied warranties of merchantability and fitness for a particular purpose, are made in relation to the accuracy, reliability or contents of this document. Nokia reserves the right to revise this document or withdraw it at any time without prior notice

The availability of particular products may vary by region. Please check with the Nokia dealer nearest to you.

EXPORT CONTROLS

This device may contain commodities, technology, or software subject to export laws and regulations from the US and other countries. Diversion contrary to law is prohibited.

Issue 3.1

Contents

For your safety	7	Scroll and make selections.....	24
About your device.....	8	Common actions in several applications.....	24
NETWORK SERVICES.....	8	Make calls	26
Enhancements, batteries, and chargers.....	8	Speed dial.....	26
Get started	10	Answer a call.....	27
Insert the SIM card and battery.....	10	Divert calls.....	27
Insert a memory card.....	11	Call barring.....	27
Charge the battery.....	12	Video calls.....	28
Switch on your device.....	12	Log.....	28
Enter basic settings.....	12	Push to talk.....	29
Keys and parts.....	13	Net calls.....	32
Keypad lock (keyguard).....	14	Device security	33
Connectors.....	14	Contacts	35
Antennas.....	14	Manage contact groups.....	35
About the display.....	15	Manage default information.....	36
Standby modes.....	15	Copy contacts between SIM and device memory.....	36
Display indicators.....	16	Select ringing tones for contacts.....	36
Volume control.....	18	Business cards.....	36
Write text.....	18	Messages	38
Change writing language.....	19	Organize messages.....	38
Memory.....	19	Search for messages.....	39
CD-ROM.....	20	Messaging settings.....	39
Nokia support and contact information.....	20	Text messages.....	39
Transfer content between devices.....	20	Multimedia messages.....	41
Your device	23	E-mail messages.....	44
Settings.....	23	Instant messaging.....	50
Menu.....	23	Special messages.....	53
Help and tutorial.....	23		

Connectivity.....	54	Screen export.....	80
Internet access points.....	54	Print.....	81
Cable connection.....	56	Settings.....	82
Bluetooth.....	56	Phone settings.....	82
SIM access profile.....	59	Call settings.....	83
Infrared.....	60	Connection settings.....	84
Data connections.....	60	Date and time settings.....	89
Connection manager.....	62	Security settings.....	89
Modem.....	62	Enhancement settings.....	89
Mobile VPN.....	63	Organiser.....	90
Email data roaming.....	63	Calendar.....	90
Web.....	65	Notes.....	91
Access points.....	65	Calculator.....	91
Browse the Web.....	65	Converter.....	92
Bookmarks.....	66	Voice mailbox.....	92
Download items.....	66	Clock.....	92
End a connection.....	67	Tools.....	94
News feeds and blogs.....	67	Positioning.....	94
Web settings.....	67	Navigator.....	94
Services.....	68	Landmarks.....	95
Media applications.....	69	Voice commands.....	95
Gallery.....	69	Voice aid.....	96
RealPlayer.....	70	Sett. wizard.....	96
Music player.....	72	Application manager.....	96
Recorder.....	73	Nokia Catalogs.....	97
Flash player.....	73	Device management.....	98
Office applications.....	75	Remote configuration network service.....	98
File manager.....	75	Data synchronization.....	98
Documents.....	75	Personalization.....	100
Sheet.....	77		
Presentation.....	78		

Profiles.....	100
Themes.....	101
Battery information.....	102
Nokia battery authentication guidelines.....	102
Care and maintenance.....	104
Additional safety information.....	105
Operating environment.....	105
Medical devices.....	105
Vehicles.....	106
Potentially explosive environments.....	106
Emergency calls.....	106
CERTIFICATION INFORMATION (SAR).....	107
Index.....	108

For your safety

Read these simple guidelines. Not following them may be dangerous or illegal. Read the complete user guide for further information.



SWITCH ON SAFELY

Do not switch the device on when wireless phone use is prohibited or when it may cause interference or danger.



ROAD SAFETY COMES FIRST

Obey all local laws. Always keep your hands free to operate the vehicle while driving. Your first consideration while driving should be road safety.



INTERFERENCE

All wireless devices may be susceptible to interference, which could affect performance.



SWITCH OFF IN HOSPITALS

Follow any restrictions. Switch the device off near medical equipment.



SWITCH OFF IN AIRCRAFT

Follow any restrictions. Wireless devices can cause interference in aircraft.



SWITCH OFF WHEN REFUELLING

Do not use the device at a refueling point. Do not use near fuel or chemicals.



SWITCH OFF NEAR BLASTING

Follow any restrictions. Do not use the device where blasting is in progress.



USE SENSIBLY

Use only in the normal position as explained in the product documentation. Do not touch the antennas unnecessarily.



QUALIFIED SERVICE

Only qualified personnel may install or repair this product.



ENHANCEMENTS AND BATTERIES

Use only approved enhancements and batteries. Do not connect incompatible products.



WATER-RESISTANCE

Your device is not water-resistant. Keep it dry.



BACK-UP COPIES

Remember to make back-up copies or keep a written record of all important information.



CONNECTING TO OTHER DEVICES

When connecting to any other device, read its user guide for detailed safety instructions. Do not connect incompatible products.



EMERGENCY CALLS

Ensure the phone function of the device is switched on and in service. Press the end key as many times as needed to clear the display and return to the standby mode. Enter the emergency number, then press the call key. Give your location. Do not end the call until given permission to do so.

About your device

The wireless device described in this guide is approved for use on the EGSM900/1800/1900, WCDMA2100 networks. Contact your service provider for more information about networks.

When using the features in this device, obey all laws, and respect privacy and legitimate rights of others.



Warning: To use any features in this device, other than the alarm clock, the device must be switched on. Do not switch the device on when wireless device use may cause interference or danger.

NETWORK SERVICES

To use the phone you must have service from a wireless service provider. Many of the features in this device depend on features in the wireless network to function. These network services may not be available on all networks or you may have to make specific arrangements with your service provider before you can utilize network services. Your service provider may need to give you additional instructions for their use and explain what

charges will apply. Some networks may have limitations that affect how you can use network services. For instance, some networks may not support all language-dependent characters and services.

Your service provider may have requested that certain features be disabled or not activated in your device. If so, they will not appear on your device menu. Your device may also have been specially configured. This configuration may include changes in menu names, menu order and icons. Contact your service provider for more information.

This device supports WAP 2.0 protocols (HTTP and SSL) that run on TCP/IP protocols. Some features of this device, such as MMS, browsing, e-mail, and content downloading using the browser or over MMS, require network support for these technologies.

Enhancements, batteries, and chargers

Check the model number of any charger before use with this device. This device is intended for use when supplied with power from the LCH-12, ACP-12, and AC-1 chargers.



Warning: Use only batteries, chargers, and enhancements approved by Nokia for use with this particular model. The use of any other types may invalidate any approval or warranty, and may be dangerous.

For availability of approved enhancements, please check with your dealer. When you disconnect the power cord of any enhancement, grasp and pull the plug, not the cord.

Your device and its enhancements may contain small parts. Keep them out of reach of small children.

Get started



Note: Your service provider may have requested that certain features be disabled or not activated in your device. If so, they do not appear on your device menu. Your device may also have been specially configured for your network provider. This configuration may include changes in menu names, menu order and icons. Contact your service provider for more information.

Model number: Nokia E60-1

Hereinafter referred to as Nokia E60.

Insert the SIM card and battery

Keep all SIM cards out of the reach of small children. For availability and information on using SIM card services, contact your SIM card vendor. This may be the service provider, network operator, or other vendor.

1. Always switch the device off, and disconnect the charger before removing the battery.

With the back of the device facing you, press and slide the back cover in the direction of the arrow.

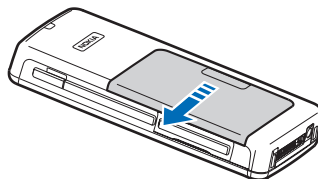

2. If the battery is installed, lift the battery from the battery compartment in the direction of the arrow to remove it.

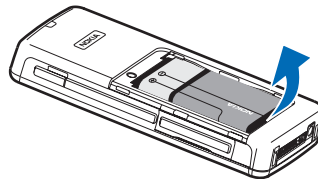

3. To release the SIM card holder, slide it in the direction of the arrow (1), and lift it (2). Insert the SIM card into the SIM card slot (3). Ensure that the beveled corner of the SIM card is pointing up and the contact area on the card is facing the device. Lower the SIM card holder (4), and slide it until it locks into place (5).

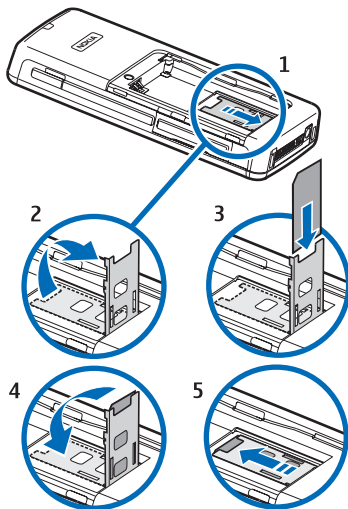

4. To insert the battery, align the contacts of the battery with the corresponding connectors on the battery compartment, insert in the direction of the arrow, and gently click the battery into place.

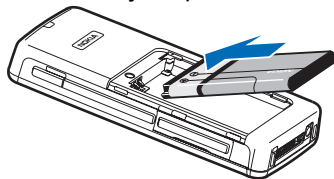

5. Insert the locking catches of the back cover into the corresponding slots, and slide the cover into place.

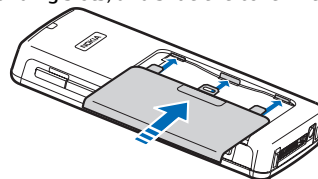

Instead of a SIM card, you may also have a USIM card, which is an enhanced version of the SIM card and is supported by UMTS (network service) mobile phones. Contact your service provider for more information and settings.

Insert a memory card

If you have a memory card, follow the instructions to insert it.

See "Memory," p. 19.

1. To open the memory card compartment, pull the door in the direction of the arrow (1).
2. Slide the memory card into the memory card slot (2). Ensure that the beveled corner of the memory card is pointing towards the device and the contact area is facing up.

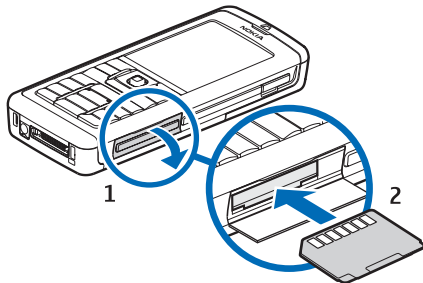

3. Close the memory card compartment door.

 **Important:** Do not remove the MMC card in the middle of an operation when the card is being accessed. Removing the card in the middle of an operation may damage the memory card as well as the device, and data stored on the card may be corrupted.

Charge the battery

1. Connect the charger to a wall outlet.
2. Connect the power cord to the bottom of the device. The battery indicator bar starts scrolling on the display. If the battery is completely discharged, it may take a few minutes before the charging indicator is shown. The device can be used while charging.
3. When the battery is fully charged, the bar stops scrolling. Disconnect the charger from the device, then from the outlet.

Switch on your device

1. To switch the device on, press the power key.
2. If the device asks for a PIN code (or UPIN code, if you have a USIM card), lock code or security code, enter the code, and select **OK**.
3. To switch the device off, press the power key.



Tip: When you switch the device on, it may recognize the SIM card provider and configure the correct text message, multimedia message, and GPRS settings automatically. If not, contact your service provider for the correct settings, or use the [Sett. wizard](#) application.

The device can be used without the network dependant phone functions when a SIM card is not inserted or when the [Offline](#) profile is selected.

The picture shows the location of the power key.

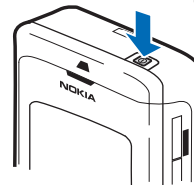

Enter basic settings

When you power on the device for the first time, and when you power on the device after the battery has been empty or removed for a longer period of time, your device

asks for the city in which you are located, time, and date. You can change the settings later.

1. Select the city in which you are located from the list and **OK**. To browse for a city, start to type the name of the city, or scroll to a city. It is important to select the correct city, because scheduled calendar entries that you create can change if the new city is located on a different time zone.
2. Set the time, and select **OK**.
3. Set the date, and select **OK**.

Keys and parts

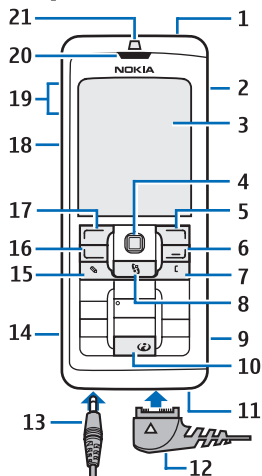

- 1 — Power key
- 2 — Integrated loudspeaker
- 3 — Display
- 4 — Joystick. Press the joystick to enter a selection. Use the joystick to scroll left, right, up, down, or to move around on the screen.
- 5 — Right selection key. Press either selection key to perform the function shown above it on the display.
- 6 — End key. Press the end key to reject a call, end active calls and held calls, close applications, and with a long keypress, end data connections (GPRS, data call).
- 7 — Clear key
- 8 — **Menu** key. Press the **Menu** key to access the applications installed in your device. With a long keypress, you can see a list of the active applications and switch between them. In this User Guide, "select **Menu**" refers to pressing this key.
- 9 — Memory card slot
- 10 — Internet key. Press and hold the key in the standby mode to browse the Web.
- 11 — Microphone. Do not cover the microphone with your hand during phone calls.
- 12 — Pop-Port™. Connector for the USB data cable, headset, and loopset.
- 13 — Charger connector
- 14 — Infrared port
- 15 — Edit key
- 16 — Call key

- 17 — Left selection key. Press either selection key to perform the function shown above it on the display.
- 18 — Voice key/Push to talk (PTT) key
- 19 — Volume keys
- 20 — Earpiece
- 21 — Light sensor

Keypad lock (keyguard)

When the keypad lock is on, calls may be possible to the official emergency number programmed into your device. Use the keypad lock to prevent the keys on the device from being accidentally pressed.

To lock the keypad in the standby mode, press the left selection key and *. To unlock, press the left selection key and * again.



Tip: To lock the keypad in the **Menu** or in an open application, press the power key briefly, and select **Lock keypad**. To unlock, press the left selection key and *.

You can also lock the device in the standby mode using your lock code. Press the power key, select **Lock phone**, and enter your lock code. To unlock, press the left selection key and *. Enter your lock code, and press the joystick.

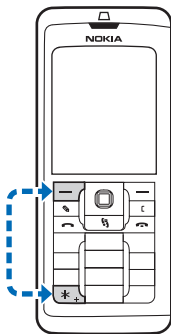

Connectors



Warning: When you use the headset, your ability to hear outside sounds may be affected. Do not use the headset where it can endanger your safety.

Pop-Port connector for headset and other enhancements

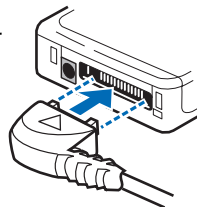

Battery charger connector

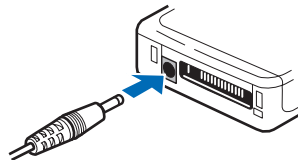

Antennas

Your device has two internal antennas.



Note: As with any other radio transmitting device, do not touch either of the antennas unnecessarily when the device is switched on. Contact with the antenna affects call quality and may cause the device to operate

at a higher power level than otherwise needed. Not touching the antenna area during a phone call optimises the antenna performance and the talktime of your device.

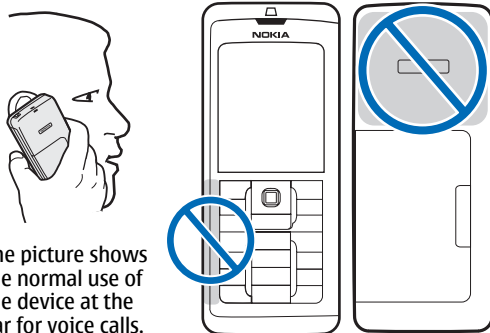

The picture shows the normal use of the device at the ear for voice calls.

About the display

A small number of missing, discolored, or bright dots may appear on the screen. This is a characteristic of this type of display. Some displays may contain pixels or dots that remain on or off. This is normal, not a fault.

Rotate the display

You can rotate the display screen on your device from portrait to landscape.

Select **Menu** > **Rotate**. You can also rotate the screen by pressing and holding the menu key and then selecting **Rotate** from the application switching window.

The display screen rotates 90 degrees clockwise from portrait to landscape and back to portrait each time you select **Rotate**.



Tip: The application switching window displays **Rotate** until you switch off the phone or use the clear key to turn off the option and close the application.

Standby modes

Your device has two different standby modes: standby mode and active standby mode.

Active standby mode

After you have switched on your device and it is ready for use, but you have not entered any characters or made other selections, the device is in the active standby mode. In the active standby mode, you can view your service provider and network, different indicators such as indicators for alarms, and applications you want to access fast.

To select applications that you want to access from active standby, select **Menu** > **Tools** > **Settings** > **Phone** > **Standby mode** > **Standby apps**. Scroll to the different shortcut settings, and press the joystick. Scroll to the desired application, and press the joystick.

To activate standby, select **Menu** > **Tools** > **Settings** > **Phone** > **Standby mode** > **Active standby** > **Off**.



Tip: You can also see the messages in a messaging folder such as inbox or mailbox in the

active standby mode. Select **Menu** > **Message**. > **Options** > **Settings** > **Other** and the folders in **Active standby mode**.

Standby mode

In the standby mode, you can see different information, such as your service provider, time, and different indicators, such as indicators for alarms.

The picture shows a the display in the standby mode.

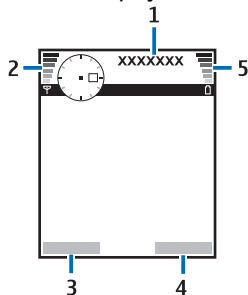

- 1 — Service provider
- 2 — Signal strength indicator
- 3 — Command for left selection key
- 4 — Command for right selection key
- 5 — Battery strength indicator

Shortcuts in standby mode

In the standby mode, you can use the following shortcuts. These shortcuts are usually not available in the active standby mode, where the joystick is used for normal scrolling.

To view the most recently dialed numbers, press the call key. Scroll to a number or name, and press the call key again to call the number.

To call your voice mailbox (network service), press and hold **1**.

To view calendar information, scroll right.

To write and send text messages, scroll left.

To open the contacts list, press the joystick.

To change the profile, press the power key briefly, scroll to the profile you want, and press the joystick to activate the profile.

To open **Services** and connect to the Web, press **0**.

To change these shortcuts, select **Menu** > **Tools** > **Settings** > **Phone** > **Standby mode**.

Display indicators

 The device is being used in a GSM network. The bar next to the icon indicates the signal strength of the network at your current location. The higher the bar, the stronger the signal.

3G The device is being used in a UMTS network (network service). The bar next to the icon indicates the signal

strength of the network at your current location. The higher the bar, the stronger the signal.

 The battery charge level. The higher the bar, the stronger the charge in the battery.

 You have one or more unread messages in the **Inbox** folder in **Messag..**

 You have received new e-mail in the remote mailbox.

 You have one or more missed phone calls.

 An alarm is active.

 You have selected the silent profile, and the device does not ring for an incoming call or message.

 Bluetooth is activated.

 An infrared connection is active. If the indicator blinks, your device is trying to connect to the other device, or the connection has been lost.

 A GPRS or EGPRS packet data connection is available.

 A GPRS or EGPRS packet data connection is active.

 A GPRS or EGPRS packet data connection is on hold.

 A UMTS packet data connection is available.

 A UMTS packet data connection is active.

 A UMTS packet data connection is on hold.

 You have set the device to scan for wireless LANs, and a wireless LAN is available.

 A wireless LAN connection is active in a network that does not have encryption.

 A wireless LAN connection is active in a network that has encryption.

 Your device is connected to a PC with a USB data cable.

 A data call is active.

 IP passthrough is active.

1 and **2** Indicate the phone line that you have selected, if you have subscribed to two phone lines (network service).

 All calls are forwarded to another number.

 A headset is connected to the device.

 The connection to a headset with Bluetooth connectivity has been lost.

 A hands-free car kit is connected to the device.

 A loopset is connected to the device.

 A **Text phone** is connected to the device.

 Your device is synchronizing.

 You have an ongoing push to talk connection.

Volume control



Warning: Do not hold the device near your ear when the loudspeaker is in use, because the volume may be extremely loud.

To adjust the volume during a call, press the volume keys.

To adjust the volume when using the loudspeaker, press the volume keys.

Write text

Traditional text input

Abc is shown on the top right of the display when you are writing text using traditional text input.

ABC and **abc** indicate the selected case. **Abc** indicates that the first letter of the word is written in uppercase and all the other letters will automatically be written in lowercase. **123** indicates number mode.

- Press a number key **1–9** repeatedly until the desired character appears. There are more characters available for a number key than are printed on the key.
- To insert a number, press and hold the number key.
- To switch between letter and number mode, press and hold **#**.
- If the next letter is located on the same key as the present one, wait until the cursor appears, and enter the letter.

- To erase a character, press the clear key. Press and hold the clear key to clear more than one character.
- To access the most common punctuation marks, press the **1** key. Press **1** repeatedly to reach the desired punctuation mark. Press ***** to open a list of special characters. Use the joystick to move through the list, and select a character.
- To insert a space, press **0**. To move the cursor to the next line, press **0** three times.
- To switch between the different character cases, press **#**.

Predictive text input

1. To activate predictive text input, press the edit key, and select **Predictive text on**. This activates predictive text input for all editors in the device. The indicator  is shown on the top right of the display when you are writing text using predictive text input.
2. To write the desired word, press **2–9**. Press each key only once for one letter.
3. When you have finished writing the word and it is correct, to confirm it, scroll right, or press **0** to add a space.

If the word is not correct, press ***** repeatedly to view the matching words the dictionary has found one by one.

If the **?** character is shown after the word, the word you intended to write is not in the dictionary. To add a word to the dictionary, select **Spell**, enter the word (up to 32 letters) using traditional text input, and select **OK**. The word is added to the dictionary. When

the dictionary is full, a new word replaces the oldest added word.

4. Start writing the next word.



Tip: To set predictive text input on or off, press # twice quickly.

Write the first half of a compound word; to confirm it, scroll right. Write the last part of the compound word. To complete the compound word, press **0** to add a space.

To turn predictive text input off for all editors in the device, press the edit key, and select **Predictive text > Off**.

Copy text to the clipboard

1. To select letters and words, press and hold the edit key. At the same time, scroll in the direction necessary to highlight the word, phrase, or line of text you want to copy. As the selection moves, the text is highlighted.
2. To copy the text to the clipboard, while still holding the edit key, select **Copy**. To insert the text into a document, press and hold the edit key, and select **Paste**.

Change writing language

If you are writing text, for example a note or a message, you can change the writing language. When you are writing and press a key several times to reach a specific character, changing the writing language gives you access to a different characters.

For example, if you are writing text using a non-Latin alphabet and want to write Latin characters for Web

addresses, select **Options > Writing language** and the writing language to have access to a language that uses Latin characters.

Memory

There are two types of memory into which you can save data or install applications: device memory and removable memory.

Select **Menu > Options > Memory details**.

You can see how much memory is currently in use, how much free memory remains, and how much memory is consumed by each data type. For example, you can see how much memory your e-mail messages, text documents, or calendar appointments consume.



Tip: To ensure that you have adequate memory, you should regularly delete or transfer data to a memory card or PC.

Memory card

Your Nokia device only supports the FAT16 file system for memory cards. If you use a memory card from another device or if you want to ensure compatibility of the memory card with your Nokia device, you may need to format the memory card with your Nokia device. However, all data in the memory card is permanently deleted if you format the memory card.

It is recommended to back up device memory regularly to the memory card. The information can be restored to your device later. To back up information from device

memory to a memory card, select **Menu > Tools > Memory card > Options > Backup phone mem.** To restore information from the memory card to the device memory, select **Menu > Tools > Memory card > Options > Restore from card.**

Do not remove a memory card when the card is being accessed. Removing the card in the middle of an operation may damage the memory card as well as the device, and data stored on the card may be corrupted.

If you cannot use a memory card in your device, you may have the wrong type of memory card, the card may not be formatted for your device, or the card has a corrupted file system.

RS-MMC

This device uses a reduced-size, dual-voltage (1.8/3.0V) MultiMediaCard (MMC).

To ensure interoperability, use only dual-voltage multimedia cards. Check the compatibility of a multimedia card with its manufacturer or provider. Use only compatible multimedia cards with this device. Other memory cards, such as full-size MMC or Secure Digital (SD) cards, do not fit in the MMC slot and are not compatible with this device. Using an incompatible memory card may damage the memory card as well as the device, and data stored on the incompatible card may be corrupted. Keep all memory cards out of the reach of small children.

CD-ROM

The sales package CD-ROM is compatible with Windows 98SE, Windows ME, Windows 2000, and Windows XP.

You can install Nokia PC Suite from the CD-ROM. Nokia PC Suite can be used only with Windows 2000 and Windows XP.

Nokia support and contact information

Check www.nokia.com/support or your local Nokia Web site for the latest version of this guide, additional information, downloads, and services related to your Nokia product.

On the Web site, you can get information on the use of Nokia products and services. If you need to contact customer service, check the list of local Nokia contact centers at www.nokia.com/customerservice.

For maintenance services, check your nearest Nokia service center at www.nokia.com/repair.

Transfer content between devices

You can transfer content, such as contacts, from a compatible Nokia device to your Nokia E60 using Bluetooth connectivity or infrared. The type of content that can be transferred depends on the phone model. If the other device supports synchronization, you can also synchronize data between the other device and your Nokia E60.

Transfer data with Bluetooth or infrared

To start transferring data from a compatible device, select **Menu > Tools > Transfer**.

Bluetooth connectivity

1. In the information view, select **Continue**.
2. Select **Via Bluetooth**. Both devices must support the selected connection type.
3. Activate Bluetooth in your other device, and select **Continue** in your Nokia E60 to start searching for devices with active Bluetooth connectivity.
4. Select **Stop** in your Nokia E60 after it has found your other device.
5. Select your other device from the list. You are asked to enter a passcode (1 to 16 digits) on your Nokia E60. The passcode is used only once to confirm this connection.
6. Enter the code on your Nokia E60, and select **OK**. Enter the passcode on your other device, and select **OK**. The devices are now paired. See "Pair devices," p. 58.

For some phone models, the **Transfer data** application is sent to your other device as a message. To install **Transfer data** on your other device, open the message, and follow the instructions on the display.

7. From your Nokia E60, select the content you want to transfer from your other device, and **OK**.

Infrared connectivity

1. In the information view, select **Continue**.

2. Select **Via infrared**. Both devices must support the selected connection type.
3. Connect the two devices. See "Infrared," p. 60.
4. From your Nokia E60, select the content you want to transfer from your other device, and **OK**.

Content is copied from the memory of the other device to the corresponding location in your device. Copying time depends on the amount of data to be transferred. You can also cancel and continue later.

The necessary steps for data transfer may vary depending on your device, and whether you have interrupted data transfer earlier. The items that you can transfer vary depending on the other device.

Synchronize data with another device

If you have previously transferred data to your Nokia E60, and your other device supports synchronization, you can use **Transfer** to keep the data of the two devices up to date.

1. Select **Phones**, and press the joystick.
2. Scroll to the device from which you transferred data, and press the joystick.
3. Select **Synchronise**, and press the joystick. The devices start synchronizing using the same connection type that you selected when you originally transferred data. Only the data that you originally selected for data transfer is synchronized.

To modify the data transfer and synchronization settings, select **Synchronise**, scroll to a device, press the joystick, and select **Edit**.

Your device

Settings

When you switch the device on, it may recognize the SIM card provider and configure the correct text message, multimedia message, and GPRS settings automatically. You may also receive the settings as a special text message from your service provider.

Menu

The **Menu** is a starting point from which you can open all applications in the device or on a memory card. The **Menu** contains applications and folders, which are groups of similar applications. Use the joystick to scroll up and down on the screen.

Applications that you install are saved in the **Installat.** folder by default.

To open an application, scroll to it, and press the joystick.

To view the applications in a list, select **Options > Change view > List**. To return back to the grid view, select **Options > Change view > Grid**.

To view the memory consumption of different applications and data stored on the device or memory card and to check the amount of free memory, select **Options > Memory details** and the memory.

To rearrange the folder, scroll to the application you want to move, and select **Options > Move**. A check mark is

placed beside the application. Scroll to a new location, and select **OK**.

To move an application to a different folder, scroll to the application you want to move to another folder, and select **Options > Move to folder**, the new folder, and **OK**.

To download applications from the Web, select **Options > App. downloads**.

To create a new folder, select **Options > New folder**. You cannot create folders inside folders.

To rename a new folder, select **Options > Rename**.



Tip: To switch between several open applications, press and hold the menu key. The application-switching window opens and displays the open applications. Scroll to an application, and press the joystick to switch to it.

Help and tutorial

You can find answers to your questions while using the device even with no user guide present, because your device includes both a task-specific help and a tutorial.



Tip: Task-specific means you can access instructions from **Options** lists.

Device help

You can access the device help from an open application or from the **Menu**. When you have an application open, select **Options** > **Help** to read instructions for the current view.

To open help from **Menu**, select **Help** > **Help**. In **Help**, you can select categories for which you want to see instructions. Scroll to a category, such as Messaging, and press the joystick to see what instructions (help topics) are available. While you are reading the topic, scroll left or right to see the other topics in that category.

When you are reading the instructions, press and hold the menu key to switch between help and the application that is open in the background.

Tutorial

The tutorial provides you information about your device and shows you how to use it.

To access the tutorial in the menu, select **Menu** > **Help**, open **Tutorial** and the section you want to view.

Scroll and make selections

Use the joystick to move and make selections. With the joystick, you can move up, down, left and right in the **Menu** or in different applications or lists. You can also press the joystick to open applications, files, or edit settings.

To select text, press and hold the edit key, and scroll left or right until you have selected the text.

To select different items, such as messages, files, or contacts, scroll up, down, left or right to highlight the item you want to select. Select **Options** > **Mark/Unmark** > **Mark** to select one item or **Options** > **Mark/Unmark** > **Mark all** to select all items.



Tip: To select almost all items, first select **Options** > **Mark/Unmark** > **Mark all**, then select the items you do not want, and **Options** > **Mark/Unmark** > **Unmark** > **Unmark**.

To select an object (for example, an attachment in a document) scroll to the object so that square markers appear on each side of the object.

Common actions in several applications

You can find the following actions in several applications:

To switch between open applications, press and hold the menu key to see a list of open applications. Select an application.

To change the profile or switch off or lock the device, press the power key briefly.

To save a file, select **Options** > **Save**. There are different save options depending on the application you use.

To send a file, select **Options** > **Send**. You can send a file in an e-mail or multimedia message, or using infrared or Bluetooth.

To print to a compatible printer, select **Options** > **Print**. You can preview items that you want to print, or edit the way printed pages look. Before you can print, you must

define a compatible printer to your device. See "Print," p. 81.

To copy, press the edit key, and select the text with the joystick. Press and hold the edit key, and select **Copy**. To paste, scroll to where you want to paste the text, press and hold the edit key, and select **Paste**. This method may not work in applications such as **Documents** that have their own copy and paste commands.

To delete a file, press the clear key, or select **Options** > **Delete**.

To insert characters such as question marks or parentheses to text, press *****.

Make calls

When the device is locked, calls still may be possible to the official emergency number programmed into your device.

In the offline profile, you may need to enter the lock code and change the device to a calling profile before making any call, including a call to an emergency number.

To make and receive calls, the device must be switched on, the device must have a valid SIM card installed, and you must be located in a service area of the cellular network. The GPRS connection is put on hold during voice calls unless the network supports dual transfer mode or you have a USIM card and are within the coverage of a UMTS network.

Enter the phone number, including the area code, and press the call key. If you enter an incorrect character, press the clear key.



Tip: For international calls, press the * key twice to add the + character that replaces the international access code, and enter the country code, area code (omit the leading 0, if necessary), and phone number.

To end the call or cancel the call attempt, press the end key.

To make a call using the saved contacts, press **Contacts** in standby mode. Enter the first letters of the name, scroll to the name, and press the call key. See "Contacts," p. 35.

Press the call key to view up to 20 numbers that you last called or attempted to call. Scroll to the desired number or name, and press the call key to dial the number. See "Log," p. 28.

Use the volume keys to adjust the volume of an active call.

To call your voice mailbox (network service) in standby mode, press and hold **1**, or press **1** then the call key.

Speed dial

Speed dialing allows you to make a call by pressing and holding a number key.

Before using speed dialing, select **Menu** > **Tools** > **Settings** > **Call** > **Speed dialing** > **On**.

To assign a number key to a phone number, select **Menu** > **Tools** > **Speed dial**. Scroll to the number key (2 - 9) on the screen, and select **Options** > **Assign**. Select the desired number from the **Contacts** directory.

To delete the phone number assigned to a number key, scroll to the speed dialing key, and select **Options** > **Remove**.

To modify a phone number assigned to a number key, scroll to the speed dialing key, and select **Options** > **Change**.

Answer a call



Note: The actual invoice for calls and services from your service provider may vary, depending on network features, rounding off for billing, taxes, and so forth.

To answer a call, press the call key.

To reject the call, press the end key.

To mute a ringing tone instead of answering a call, select **Silence**.

To answer a new call during a call when the **Call waiting** function is activated, press the call key. The first call is put on hold. To end the active call, press the end key.

Divert calls

Select **Menu** > **Tools** > **Settings** > **Call divert**.

Divert incoming calls to your voice mailbox or to another phone number. For details, contact your service provider.

1. Select a call type from the following:
 - **Voice calls** — Incoming voice calls.
 - **Data and video calls** — Incoming data and video calls.
 - **Fax calls** — Incoming fax calls.
2. Select one of the following call diverting options:
 - **All voice calls**, **All data and vid. calls**, or **All fax calls**. — Divert all incoming voice, data and video, or fax calls.
 - **If busy** — Divert incoming calls when you have an active call.

- **If not answered** — Divert incoming calls after your device rings for a specified period of time. Define the time you let the device ring before diverting the call in the **Delay time:** field.
- **If out of reach** — Divert calls when the device is switched off or out of network coverage.
- **If not available** — Activate the last three settings at the same time. This option diverts calls if your device is busy, not answered, or out of reach.

3. Select **Activate**.

To check the current diverting status, scroll to the diverting option, and select **Options** > **Check status**.

To stop diverting voice calls, scroll to the diverting option, and select **Options** > **Cancel**.

Call barring

Call barring and call diverting cannot be active at the same time.

When calls are barred, calls still may be possible to certain official emergency numbers.

Select **Menu** > **Tools** > **Settings** > **Call barring**.

You can bar the calls that can be made or received with the device (network service). To change the settings, you need the barring password from your service provider. Call barring affects all calls, including data calls.

To bar calls, select **Cellular call barring** and select from the following options:

- **Outgoing calls** — Prevent making voice calls with your device.
- **Incoming calls** — Bar incoming calls.

- **International calls** — Prevent calling to foreign countries or regions.
- **Incoming if abroad** — Bar incoming calls when outside your home country.
- **Intern. except home** — Prevent calls to foreign countries or regions, but to allow calls to your home country.

To check the status of voice call barrings, scroll to the barring option, and select **Options** > **Check status**.

To stop all voice call barrings, scroll to a barring option, and select **Options** > **Cancel all barrings**.

Net call barring

To bar net calls, select **Menu** > **Tools** > **Settings** > **Call barring** > **Internet call barring**.

To reject net calls from anonymous callers, select **Anonymous calls** > **On**.

Video calls

To be able to make a video call, you must be within the coverage of a UMTS network. For availability of and subscription to video call services, contact your network operator or service provider. While talking, you can send a still image to the recipient's compatible mobile phone and see a real-time video sent by the recipient, if the recipient has a compatible mobile phone with a video camera. A video call can only be made between two parties.



Warning: Do not hold the device near your ear when the loudspeaker is in use, because the volume may be extremely loud.

Select the still image to be sent in **Tools** > **Settings** > **Call settings** > **Image in video call**.

To make a video call, enter the phone number or select the recipient of the call from **Contacts**, and select **Options** > **Call** > **Video call**. You cannot convert the video call to a normal voice call.

During the call, select **Options** and from the following:

- **Audio** — Talk to the recipient of the call.
- **Use video** — See video without audio.
- **Loudsp.** — Select to use the loudspeaker for receiving audio.
- **Handset** — Mute the loudspeaker and use the handset.

Log

Select **Menu** > **Log**.

In the **Log**, you can view information about the communication history of the device.

To view the logs for recent voice calls, their approximate duration, and packed data connections, select **Recent calls**, **Call duration**, or **Packet data**; and press the joystick.

To sort the events by type or direction, scroll right to open the general log, and select **Options** > **Filter**. Scroll to a filter type, and press the joystick. Select the type or direction, and press the joystick.

To set the time how long all communication events are held in the log, select **Options** > **Settings** > **Log duration**, an option, and **OK**.

To clear missed and received calls and dialed numbers, select **Recent calls** > **Options** > **Clear recent calls**.

Push to talk

Select **Menu** > **Connect** > **PTT**.

Push to talk (PTT) (network service) provides direct voice communication connected with the push of a key. With push to talk, you can use your device as you would use a walkie-talkie.

You can use push to talk to have a conversation with one person or with a group of people, or to join a channel. A channel is like a chat room: you can call the channel to see if anyone is online. The channel call does not alert the other participants; the participants just join the channel and start speaking with each other.

In push to talk communication, one person talks while the other participants listen through the built-in loudspeaker. Participants take turns responding to each other. Because only one participant can talk at a time, the maximum duration of a speech turn is limited. For details of the speech turn duration for your network, contact your network operator or service provider.

Remember to hold the device in front of you during a push to talk call so you can see the display. Speak towards the microphone, and do not cover the loudspeaker with your hands.

Phone calls always take priority over push to talk.

Before you can use push to talk, you must define the push to talk access point and push to talk settings. You may receive the settings in a special text message from the service provider that offers the push to talk service.

User settings

Select **Options** > **Settings** > **User settings**.

Define the following:

- **Incoming PTT calls** — Select **Notify** if you want to see a notification of incoming calls. Select **Auto-accept** if you want push to talk calls to be answered automatically. Select **Not allowed** if you want push to talk calls to be rejected automatically.
- **PTT call alert tone** — Select **Set by profile** if you want the incoming call alert setting for push to talk to follow your profile settings. If your profile is silent, you are not available to others using push to talk, except for callback requests.
- **Callback request tone** — Define the ringing tone for callback requests.
- **Application start-up** — Select if you want to log in to the push to talk service when you switch on your device.
- **Default nickname** — Enter your default nickname (20 characters maximum) that is displayed to other users.
- **Show my PTT address** — Define if you want callers to see your push to talk address. You can let all callers see the address, show the address only to one-to-one callers or channel participants, or hide the address from all callers.
- **Show my login status** — Define whether your login to the push to talk server is shown or hidden from other users.

Connection settings

Select [Options](#) > [Settings](#) > [Connection settings](#).

Define the following:

- **Domain** — Enter the domain name obtained from your service provider.
- **Access point name** — Select the push to talk access point.
- **Server address** — Enter the IP address or domain name of the push to talk server obtained from your service provider.
- **User name** — Enter your user name obtained from your service provider.
- **PTT password** — Enter a password, if required, to log into the push to talk service. The password is provided by the service provider.

Log in to push to talk service

If you have set [Application start-up](#) on in [User settings](#), push to talk automatically logs in to the service when started. If not, you must log in manually.

To log in to a push to talk service, select [Options](#) > [Settings](#) > [Connection settings](#), and enter your [User name](#), [PTT password](#), [Domain](#), [Server address](#), and [Access point name](#). Select [Options](#) > [Switch PTT on](#).

When the [Ringing type](#) setting of your device is set to [Beep once](#) or [Silent](#), or there is an ongoing phone call, you cannot make or receive push to talk calls.

Push to talk calls



Warning: Do not hold the device near your ear when the loudspeaker is in use, because the volume may be extremely loud.

Select [Options](#) > [PTT contacts](#).

To make a push to talk call, select one or several contacts from the list, and press the voice key. Remember to hold the device in front of you during a push to talk call so you can see the display. The display informs you when it is your turn to speak. Speak towards the microphone, and do not cover the loudspeaker with your hands. Press and hold the voice key the entire time you are talking. When you have finished talking, release the key.

To end the push to talk call, press the end key.

Answer or reject a call

When you receive a push to talk call, press the call key to answer the call or the end key to dismiss the call.

Callback requests

To send a callback request, select [Options](#) > [PTT contacts](#), scroll to the desired contact, and select [Options](#) > [Send callback request](#).

To answer a callback request, select [Show](#) to open the callback request. To make a push to talk call to the sender, press the voice key.

Contacts view

To view, add, modify, delete, or call contacts, select **Options** > **PTT contacts**. A list of names from your device **Contacts** application is displayed with information about their login status.

To call a selected contact, select **Options** > **Talk 1 to 1**. To make a group call, select **Options** > **Make PTT group call**.

To send the contact a request to call you, select **Options** > **Send callback request**.

Create a channel

A channel is like a chat room: you can call the channel to see if anyone is online. The channel call does not alert the other participants; the participants just join the channel and start speaking with each other.

To create a channel, select **Options** > **New channel** > **Create new**.

Select **Options** and define the following:

- **Channel name** — Write the channel name.
- **Channel privacy** — Select **Private** or **Public**.
- **Nickname in channel** — Enter your nickname (20 characters maximum) that is displayed to other users.
- **Channel thumbnail** — Insert a picture that describes the channel.

To delete a channel, press the clear key.

When you log in to push to talk, push to talk automatically connects to the channels that were active when the application was last closed.

Register PTT channels

To register a channel to the push to talk service, select **Options** > **Register**.

To edit the channel details, select **Options** > **Edit**.

Join a channel

To join a channel, select **Options** > **PTT channels**. Select the channel you want to talk to, and press the voice key. Remember to hold the device in front of you during a push to talk call so you can see the display. The display informs you when it is your turn to speak. Speak towards the microphone, and do not cover the loudspeaker with your hands. Press and hold the voice key the entire time you are talking. When you have finished talking, release the key.

To switch between channels during multiple calls, select **Swap**. The active channel is highlighted.

To view the currently active participants in the channel, select **Options** > **Active members**.

To invite a participant to a channel, select **Options** > **Send invitation**.

Push to talk log

To open the push to talk log, select **Options** > **PTT log**. The log shows the date, time, duration, and other details of your push to talk calls.

Exit push to talk

Select **Options** > **Exit**. Select **Yes** to log out and close the service. Press **No** if you want to keep the application active on the background.

Net calls

Your device supports voice calls over the Internet (Internet calls). Your device attempts emergency calls primarily over cellular networks. If an emergency call using cellular networks is not successful, then your device attempts an emergency call through your Internet call provider. Due to the established nature of cellular telephony, you should use cellular networks for emergency calls, if possible. If you have cellular network coverage available, please make sure that your cellular phone is switched on and ready to make calls before you attempt an emergency call. The capability for an emergency call using Internet telephony depends on the availability of a WLAN network and your Internet call provider's implementation of emergency call capabilities. Contact your Internet call provider to check the Internet telephony emergency call capability

VoIP (voice over Internet protocol) technology is a set of protocols that facilitate phone calls over an IP network, such as the Internet. VoIP phone calls can be established between computers, between mobile phones, and between a VoIP device and a traditional telephone. To make or receive a VoIP call, your device must be within WLAN coverage, for example.

Before you can make net calls, you need to create a net telephone profile. When the profile is ready, you can make

a net call from all applications where you can create a regular voice call. To make a net call to an address that does not start with a digit, press any number key when the device is in standby mode, then press # for a few seconds to clear the display and to switch the device from number mode to letter mode. Write the address and press the call key.

You must define session initiation protocols (SIP) settings in **Menu** > **Tools** > **Settings** > **Connection** > **SIP settings** and VoIP settings in **Menu** > **Tools** > **Settings** > **Call** and **Menu** > **Tools** > **Settings** > **Call** > **Connection**. Contact your service provider for more information and correct settings.

Preferred profile

Select **Menu** > **Connect** > **Internet tel.** to change settings.

Before you can select the default profile, you must create profiles in **Menu** > **Tools** > **Settings** > **Connection** > **Internet tel. settings**.

To select the profile that is used by default when you make net calls, select **Preferred profile**, and press the joystick. Scroll to the desired profile, and press the joystick.

Register profiles

Only those profiles where you have selected **Registration** > **When needed** setting in **Menu** > **Tools** > **Settings** > **Connection** > **Internet tel. settings** are shown in the list.

To change the registration of your net telephone profiles, scroll to the profile that you want to register or unregister, and press the joystick. Press the joystick again to select **Registered** or **Not registered**.

To save your settings, select **Back**.

Device security

Select **Menu** > **Tools** > **Settings** > **Security** > **Phone and SIM**.

You can modify the security settings for the PIN code, automatic lock, and SIM card change, and change codes and passwords.

Avoid using codes that are similar to emergency numbers to prevent accidental dialing of the emergency number.

Codes are shown as asterisks. When you change a code, enter the current code, then the new code twice.

Define security settings

To define device and SIM card settings, select a setting and **Options** > **Change**.

When calls are limited to closed user groups, calls may be possible to the official emergency number programmed into your device.

Define the following settings:

- **PIN code request** — Select **On** to request that the PIN code is entered each time the device is switched on. This setting cannot be changed if the device is switched off. Some SIM cards do not allow turning off the PIN code request.
- **PIN code** — Change the PIN code. The PIN code must be 4 to 8 numbers long. The PIN code protects your SIM card against unauthorized use and is provided with the SIM card. After three consecutive incorrect PIN code entries, the PIN code is blocked, and you need to use the PUK code to unblock it before you can use the SIM card again.
- **PIN2 code** — Change the PIN2 code. The PIN2 code must be 4 to 8 numbers long. The PIN2 code is required to access some functions of the device and is provided with the SIM card. After three consecutive incorrect PIN2 code entries, the PIN2 code is blocked, and you need to use the PUK2 code to unblock it before you can use the SIM card again.
- **Autolock period** — Set a time-out after which the device is automatically locked and can be used only if the correct lock code is entered. Enter a number for the time-out in minutes, or select **None** to turn off the autolock period. When the device is locked, you can still answer incoming calls and calls may still be possible to the official emergency number programmed into your device.
- **Lock code** — The new code can be 4-256 characters long. Both alphabets and digits can be used, and both uppercase and lowercase alphabets are possible. The device notifies you if the lock code is not properly formatted. The device remembers the previously used lock codes and prevents you from using the same lock code several times.
- **Lock if SIM changed** — Set the device to ask for the lock code when an unknown, new SIM card is inserted into your device. The device maintains a list of SIM cards that are recognized as the owner's cards.
- **Allow remote lock** — If you set this option on, you can lock the device by sending a predefined text message

from another phone. When you set this option on, you need to enter the remote lock message and confirm the message. The message must be at least 5 characters long.

- **Closed user group** (network service) — Specify a group of people to whom you can call and who can call you.
- **Confirm SIM services** (network service) — Set the device to display confirmation messages when you are using a SIM card service.

Change the barring password

To change the password used for barring voice, fax, and data calls, select **Menu > Tools > Settings > Call barring > Cellular call barring > Options > Edit barring password**. Enter the current code, then the new code twice. The barring password must be four digits long. For details, contact your service provider.

Fixed dialing

When fixed dialing is activated, calls may be possible to the official emergency number programmed into your device.

Select **Menu > Contacts > Options > SIM contacts > Fixed dialing contacts**.

With the fixed dialing service, you can restrict calls from your device to only certain phone numbers. Not all SIM cards support the fixed dialing service. Contact your service provider for more information.

Select **Options**, and select from the following options:

- **Activ. fixed dialing** — Restrict calls from your device. To cancel the service, select **Deact. fixed dialing**. You need your PIN2 code to activate and deactivate fixed dialing or edit your fixed dialing contacts. Contact your service provider if you do not have the code.
- **New SIM contact** — Add a phone number to the list of numbers to which calls are allowed. Enter the contact name and phone number. To restrict calls by a country prefix, enter the country prefix in **New SIM contact**. All phone numbers to which calls are allowed must start with this country prefix.
- **Copy to Contacts** — Copy the fixed dialing contact to **Contacts**.
- **Add from Contacts** — Copy a contact from **Contacts** to your fixed dialing list.



Tip: To send text messages to the SIM contacts while the fixed dialing service is active, you need to add the text message center number to the fixed dialing list.

To view or edit a phone number to which calls from your device are allowed, select **Options > SIM contacts > Fixed dialing contacts**.

To call the contact, press the call key.

To edit the phone number, select **Options > Edit**. You may need your PIN2 code to edit your fixed dialing numbers.

To delete the contact, press the clear key.

Contacts

Select **Menu** > **Contacts**.

Manage all of your contact information, such as phone numbers and addresses. Add a personal ringing tone, voice tag, or a thumbnail image to a contact. Send contact information to compatible devices or receive contact information as business cards from compatible devices, and add them to your own list of contacts.

To add a contact, select **Options** > **New contact**. Enter the contact information, and select **Done**.

To edit information in a contact card, scroll to the contact, and select **Options** > **Edit**. Select from the following options:

- **Add thumbnail** — Add a thumbnail image that will display when a contact calls you. The image must be previously saved to your device or memory card.
- **Remove thumbnail** — Remove the image from the contact card.
- **Add detail** — Add fields of information to a contact card, such as **Job title**.
- **Delete detail** — Delete any details that you added to a contact card.
- **Edit label** — Edit the field names of the contact card.
- **Writing language** — Select the writing language for the contact card.

Manage contact groups

Create a contact group so that you can send text or e-mail messages to several recipients at the same time.

1. Scroll to the right, and select **Options** > **New group**.
2. Enter a name for the group or use the default name, and select **OK**.
3. Open the group, and select **Options** > **Add members**.
4. Scroll to each contact you want to add to the group, and press the joystick to mark it.
5. Select **OK** to add all marked contacts to the group.

The following options are available when you select **Options** in the contact groups view:

- **PTT options** — Make a push to talk call either to an individual or to a group, or send a callback request.
- **Open** — Open the contact group and view the group members.
- **Create message** — Send a message.
- **New group** — Create a new contact group.
- **Delete** — Delete a contact group.
- **Rename** — Rename the contact group.
- **Ringing tone** — Assign a ringing tone to a contact group.
- **Contacts info** — View the information for a contact group.
- **Settings** — Set the name display settings for contact group members.

Manage default information

Assign a default number or address to a contact so you can easily call or send a message to the default number or address, even if several numbers or addresses are saved to that contact.

To change default information for a contact, open the contact, and select **Options** > **Defaults**. Select the number or address you want to set as a default, and select **OK**.

The default number or address is underlined in the contact.

Copy contacts between SIM and device memory

For availability and information on using SIM card services, contact your SIM card vendor. This may be the service provider, network operator, or other vendor.

To copy contacts from a SIM card to device memory, select **Options** > **SIM contacts** > **SIM directory** to open the SIM directory. Mark the contacts you want to copy, or select **Mark all** to copy all contacts. Select **Options** > **Copy to Contacts**.

To copy contacts from the device memory to a SIM card, select **Options** > **Copy to SIM direct..** Mark the contacts you want to copy, or select **Mark all** to copy all contacts. Select **Options** > **Copy to SIM direct..**

Select **Options** > **SIM contacts** > **SIM directory** to see the names and numbers stored on the SIM card. In SIM directory you can add, edit, or copy numbers to **Contacts**, and you can make calls.

Select ringing tones for contacts

Select a ringing tone for a contact or contact group. If the caller's phone number is sent with the call and your device recognizes the number, the ringing tone plays when the contact calls you.

To select a ringing tone for a contact or contacts group, open the contact or contact group, and select **Options** > **Ringing tone**. A list of ringing tones opens. Select the ringing tone you want to use, and select **OK**.

To remove the ringing tone, select **Default tone** from the list of ringing tones.

Business cards

Select **Menu** > **Contacts**.

You can send, receive, view, and save contact cards as business cards in vCard or Nokia Compact Business Card format.

You can send business cards to compatible devices using SMS, MMS, or e-mail, or an infrared or Bluetooth connection.

To send a business card, select the contact card from the contacts list, and select **Options** > **Send**. Select **Via text message**, **Via multimedia**, **Via e-mail**, **Via Bluetooth**, or **Via infrared**. Enter the phone number or address, or add a recipient from the contacts list. Select **Options** > **Send**. If you select SMS as the sending method, contact cards are sent without images.

To view a received business card, select **Open** from the displayed notification, or open the message from the inbox folder in **Message**.

To save a business card, select **Options** > **Save business card** when the incoming message appears on the device.

To save a received business card, select **Options** > **Save business card**.

To delete a received business card, select **Options** > **Delete**.

Messages

Select **Menu** > **Message**.

Before sending or receiving messages, you may need to do the following:

- Insert a valid SIM card in the device and be located in a service area of the cellular network.
- Verify that the network supports the messaging features you want to use and that they are activated on your SIM card.
- Define Internet access point (IAP) settings on the device. See "Access points," p. 84.
- Define e-mail account settings on the device. See "E-mail account settings," p. 48.
- Define SMS settings on the device. See "Text message settings," p. 40.
- Define MMS settings on the device. See "Multimedia message settings," p. 44.

The device may recognize the SIM card provider and automatically configure some of the message settings. If not, you may need to define the settings manually, or contact your service provider, network operator, or Internet service provider to configure the settings.

The **Message** application displays each type of messaging folder in a list format with the newest message displayed first in each folder.

Select one of the following:

- **New message** — Create and send a new text, multimedia, or e-mail message.
- **Inbox** — View received messages, except e-mails and cell broadcast messages.
- **My folders** — Create your own folders to store messages and templates.
- **Mailbox** — View and reply to received e-mail.
- **Drafts** — Store messages that have not been sent.
- **Sent** — Store messages that have been sent.
- **Outbox** — View messages waiting to be sent.
- **Reports** — View information about the delivery of sent messages.

Organize messages

To create a new folder to organize your messages, select **My folders** > **Options** > **New folder**. Enter the folder name, and select **OK**.

To rename a folder, select the folder and **Options** > **Rename folder**. Enter the new folder name, and select **OK**. You can only rename folders that you have created.

To move a message to another folder, open the message, and select **Options** > **Move to folder**, the folder, and **OK**.

To sort messages in a specific order, select **Options** > **Sort by**. You can sort the messages by **Date**, **Sender**, **Subject**, or **Message type**.

Search for messages

To search for a message, open the folder in which you want to search, select **Options** > **Find**. Enter the search term, and select **OK**.

Messaging settings

Select **Options** > **Settings**.

To define or edit settings for different message types, select **Text message**, **Multimedia message**, **E-mail**, **Service message**, **Cell broadcast**, or **Other**.

See "Text message settings," p. 40.

See "Multimedia message settings," p. 44.

See "E-mail account settings," p. 48.

Other settings

Select **Menu** > **Msgag.** > **Options** > **Settings** > **Other**.

Select from the following:

- **Save sent messages** — Select whether to store sent messages in the **Sent** folder.
- **No. of saved msggs.** — Enter the number of sent messages that you want to save. When the limit is reached, the oldest message is deleted.
- **Memory in use** — Select where to save your received messages. You can save messages to memory card only if a memory card is inserted.
- **New e-mail alerts** — Select whether you want to be alerted when a new message arrives in your mailbox.

- **Active standby mode** — Select the messaging folder (for example, your inbox or an e-mail account) that you want to see in the active standby mode.
- **Folder view** — Define how you want the messages in the inbox to be shown.

The settings available for editing may vary.

Text messages

Your device supports the sending of text messages beyond the character limit for a single message. Longer messages are sent as a series of two or more messages. Your service provider may charge accordingly. Characters that use accents or other marks, and characters from some language options like Chinese, take up more space limiting the number of characters that can be sent in a single message.

Write and send text messages

Select **Menu** > **Msgag.** > **New message** > **Text message**.

1. In the **To** field, press the joystick to select recipients from **Contacts**, or enter the recipients' mobile phone numbers manually. If you enter more than one number, separate the numbers with a semicolon. To insert a semicolon, press *****.
2. Enter the text of the message. To use a template, select **Options** > **Insert** > **Template**.
3. Select **Options** > **Send** to send the message.



Note: When sending messages, your device may display Message Sent. This is an indication that the message has been sent by your device to the message center number programmed into your device. This is not an indication that the message has been received at the intended destination. For more details about messaging services, check with your service provider.

Reply to received text messages

To reply to a text message, open the message from the **Inbox**. Select **Options** > **Reply**. Enter the text of the message, and select **Options** > **Send**.

To call the sender of a text message, open the message from the **Inbox**, and select **Options** > **Call**.

Text messages on the SIM card

Text messages may be stored on your SIM card. Before you can view SIM messages, you must copy the messages to a folder in the device. After copying the messages to a folder, you can view them in the folder or delete them from the SIM card.

Select **Options** > **SIM messages**.

1. Select **Options** > **Mark/Unmark** > **Mark** or **Mark all** to mark every message.
2. Select **Options** > **Copy**.
3. Select a folder and **OK** to begin copying.

To view SIM card messages, open the folder where you copied the messages, and open a message.

To delete a text message from the SIM card, select the message, and press the clear key.

Text message settings

Select **Options** > **Settings** > **Text msg.**.

Define the following:

- **Message centres** — View the available message centers for your device.
- **Msg. centre in use** — Select a message center to send the message.
- **Character encoding** — Select **Reduced support** to use automatic character conversion to another encoding system when available.
- **Receive report** — Select **Yes** if you want that the network sends you delivery reports on your messages (network service).
- **Message validity** — Select how long the message center resends your message if the first attempt fails (network service). If the recipient cannot be reached within the validity period, the message is deleted from the message center.
- **Message sent as** — Convert the message to another format, such as **Text**, **Fax**, **Paging** or **E-mail**. Change this option only if you are sure that your message center is able to convert text messages into these other formats. Contact your network operator.
- **Preferred conn.** — Select the preferred method of connection when sending text messages from your device.

- **Reply via same ctr.** — Select whether you want the reply message to be sent using the same text message center number (network service).

Picture messages



Note: Picture message function can be used only if it is supported by your network operator or service provider. Only devices that offer picture message features can receive and display picture messages.

Select **Menu** > **Messag.**

To view a picture message, open the message from the **Inbox** folder.

Forward picture messages

Copyright protections may prevent some images, ringing tones, and other content from being copied, modified, transferred or forwarded.

1. In the **Inbox**, open a picture message and select **Options** > **Forward**.
2. In the **To** field, enter a recipient's number, or press the joystick to add a recipient from **Contacts**. If you enter more than one number, separate the numbers with a semicolon. To insert a semicolon, press *****.
3. Enter the text of your message. The text can have 120 characters. To use a template, select **Options** > **Insert** > **Template**.
4. To send the message, press the call key.



Tip: To remove the picture from the message, select **Options** > **Remove picture**.

Multimedia messages

A multimedia message (MMS) can contain text and objects such as images, sound clips, or video clips.



Note: Only devices that have compatible features can receive and display multimedia messages. The appearance of a message may vary depending on the receiving device.

Before you can send or receive multimedia messages on your device, you must define the multimedia message settings. Your device may have recognized the SIM card provider and automatically configured the multimedia message settings. If not, contact your service provider. See "Multimedia message settings," p. 44.

Create and send multimedia messages

The default setting of the multimedia message service is generally on.

Select **New message** > **Multimedia message**.

Copyright protections may prevent some images, ringing tones, and other content from being copied, modified, transferred or forwarded.

1. In the **To** field, press the joystick to select recipients from **Contacts**, or enter the recipients' mobile phone numbers or e-mail addresses manually.

- In the **Subject** field, enter a subject for the message. To change the fields that are visible, select **Options** > **Address fields**.
- Enter the text of the message, and select **Options** > **Insert object** to add media objects. You can add objects such as **Image**, **Sound clip**, or **Video clip**.
The wireless network may limit the size of MMS messages. If the inserted picture exceeds this limit, the device may make it smaller so that it can be sent by MMS.
- Each slide of your message can contain only one video or audio clip. To add more slides to your message, select **Options** > **Insert new** > **Slide**. To change the order of slides in your message, select **Options** > **Move**.
- To preview a multimedia message before sending it, select **Options** > **Preview**.
- Press the joystick to send the multimedia message.

Create presentations

Select **New message** > **Multimedia message**.

- In the **To** field, press the joystick to select recipients from **Contacts**, or enter the recipients' mobile phone numbers or e-mail addresses manually.
- Select **Options** > **Create presentation** and a presentation template.



Tip: A template may define which media objects you can include in the presentation, where they appear, and which effects are displayed between images and slides.

- Scroll to a text area and enter the text.
- To insert images, sound, video, or notes in your presentation, scroll to the corresponding object area, and select **Options** > **Insert**.



Tip: To move between object areas, scroll up and down.

- To add slides, select **Insert** > **New slide**.
- Select **Options** and from the following:
 - Preview** — See what your multimedia presentation looks like when it is opened. Multimedia presentations may only be viewed in compatible devices that support presentations. They may appear different in different devices.
 - Backgrnd. settings** — Select the background color for the presentation and background images for different slides.
 - Effect settings** — Select effects between images or slides.

Creating multimedia presentations is not possible if **MMS creation mode** is **Restricted**. To change **MMS creation mode**, select **Msgag.** > **Options** > **Settings** > **Multimedia message**.

The available options may vary.

To send your multimedia presentation, press the call key.



Tip: To save the message in **Drafts** without sending it, select **Done**.

Receive and reply to multimedia messages



Important: Multimedia message objects may contain viruses or otherwise be harmful to your device or PC. Do not open any attachment if you are not sure of the trustworthiness of the sender.

Before you can send or receive multimedia messages on your device, you must define the multimedia message settings. Your device may have recognized the SIM card provider and automatically configured the multimedia message settings. If not, contact your service provider. See "Multimedia message settings," p. 44.

If you receive multimedia messages containing objects unsupported by your device, you cannot open them.

1. To reply to a multimedia message, open the message from the **Inbox**, and select **Options** > **Reply**.
2. Select **Options** > **To sender** to reply to the sender with a multimedia message or **Options** > **Via text message** to reply to the sender with a text message.
3. Enter the text of the message, and press the joystick to send it.

View presentations

Open the **Inbox**, scroll to a multimedia message that contains a presentation, and press the joystick. Scroll to the presentation, and press the joystick.

To pause the presentation, press either selection key below the display.

After you pause the presentation or playing finishes, select **Options** and from the following:

- **Open link** — Open a Web link and browse the Web page.
- **Activate scrolling** — Scroll text or images too large to fit on the display.
- **Continue** — Resume playing the presentation.
- **Play** — Replay the presentation from the start.
- **Find** — Find phone numbers and e-mail or Web addresses the presentation may contain. You may use these numbers and addresses to make calls, send messages, or create bookmarks, for example.

The available options may vary.

View media objects

Open the **Inbox**, scroll to a received multimedia message and press the joystick. Select **Options** > **Objects**.

To view or play a media object, scroll to it, and press the joystick.

Media objects and message attachments may contain viruses or other harmful software. Do not open any objects or attachments unless you are sure of the trustworthiness of the sender.

To save a media object in its corresponding application, scroll to the object, select **Options** > **Save**.

To send a media object to compatible devices, scroll to it, and select **Options** > **Send**.



Tip: If you receive multimedia messages that contain media objects your device cannot open, you may be able to send these objects to another device such as a computer.

Multimedia message settings

Select **Options** > **Settings** > **Multimedia message**.

Define the following settings:

- **Image size** — Select **Small** or **Large** to scale images in multimedia messages. Select **Original** to maintain the original image size of multimedia messages.
- **MMS creation mode** — Select **Restricted** to have your device prevent you from including content in multimedia messages that may not be supported by the network or the receiving device. To receive warnings about including such content, select **Guided**. To create a multimedia message with no restrictions on attachment type, select **Free**. If you select **Restricted**, creating multimedia presentations is not possible.
- **Access point in use** — Select the default access point to connect to the multimedia message center. You may not be able to change the default access point if it is preset in your device by your service provider.
- **Multimedia retrieval** — Select **Always automatic** to always receive multimedia messages automatically, **Aut. in home network** to receive notification of a new multimedia message that you can retrieve from the message center (for example, when you are traveling abroad and are outside your home network), **Manual** to retrieve multimedia messages from the message center manually, or **Off** to prevent receipt of any multimedia messages.
- **Allow anon. msgs.** — Select whether you want to receive messages from unknown senders.
- **Receive adverts** — Select whether you want to receive messages defined as advertisements.

- **Receive report** — Select **Yes** to have the status of the sent message to be shown in the log (network service). Receiving a delivery report of a multimedia message that has been sent to an e-mail address may not be possible.
- **Deny report sending** — Select **Yes** to not send delivery reports from your device for received multimedia messages.
- **Message validity** — Select how long the messaging center tries to send the message (network service). If the recipient of a message cannot be reached within the validity period, the message is removed from the multimedia messaging center. **Maximum time** is the maximum amount of time allowed by the network.

E-mail messages

To receive and send mail, you must have a remote mailbox service. This service may be offered by an Internet service provider, a network service provider, or your company. Your device is compliant with Internet standards SMTP, IMAP4 (revision 1), and POP3, and with different push e-mail solutions. Other e-mail providers may offer services with different settings or features than those described in this user guide. Contact your e-mail provider or service provider for more details.

Before you can send, receive, retrieve, reply to, and forward mail on your device, you must also do the following:

- Configure an Internet access point (IAP). See "Access points," p. 84.

- Set up an e-mail account, and define the e-mail settings correctly. See "E-mail account settings," p. 48.

Follow the instructions from your remote mailbox and Internet service providers. Contact your network and Internet service providers or operator for the correct settings.

Set up your e-mail

If you select **Mailbox** and have not set up your e-mail account, you are prompted to do so. To start setting up the e-mail account with the mailbox guide, select **Yes**.

1. To start entering the e-mail settings, select **Start**.
2. In **Mailbox type**, select **IMAP4** or **POP3**, and select **Next**.



Tip: POP3 is a version of the post office protocol that is used to store and retrieve e-mail or Internet mail messages. IMAP4 is a version of the Internet message access protocol that lets you access and manage e-mail messages while the messages are still on the e-mail server. You can then choose which messages to download to your device.

3. In **My e-mail address**, enter your e-mail address. To insert @ or other special characters, press *. To insert a full stop, press 1. Select **Next**.
4. In **Incoming mail serv.**, enter the name of the remote server that receives your e-mail, and select **Next**.
5. In **Outgoing mail serv.**, enter the name of the remote server that sends your e-mail, and select **Next**. Depending on your mobile operator, you might have

to use your mobile operator's outgoing mail server instead of your e-mail provider's.

6. In **Access point**, select the Internet access point your device should use when it retrieves the e-mails. If you select **Always ask**, each time the device starts to retrieve e-mail, it asks which Internet access point it should use, but if you select an access point, the device makes the connection automatically. Select **Next**.



Tip: If you select **Select group**, the device makes the connection automatically using the best available Internet access point from the access point group. Select the access point group, and **Back** to save the selection.

7. Enter a name for your new mailbox, and select **Finish**.

When you create a new mailbox, the name you give to the mailbox replaces **Mailbox** in the **Message** main view. You can have up to six mailboxes.

Select your default mailbox

If you have defined several mailboxes, you can select one of them as your default mailbox. To define the default mailbox, select **Options** > **Settings** > **E-mail** > **Mailbox in use** and the mailbox.

If you have defined several mailboxes, you must select the mailbox that you want to use every time you start composing a new e-mail message.

Connect to mailbox

E-mail addressed to you is not automatically received by your device, but by your remote mailbox. To read your e-mail, you must first connect to the remote mailbox; then select the e-mails you wish to retrieve into your device.

To receive and send e-mail, you need to register for an e-mail service. To set up a mailbox in your device, select **Message** > **Options** > **Settings** > **E-mail** > **Options** > **New mailbox**. Contact your service provider for the correct settings.

To retrieve received e-mail messages to your device and view them offline, select your mailbox in the **Message** main view. When the device asks **Connect to mailbox?**, select **Yes**.

To view e-mail messages in a folder, scroll to the folder, and press the joystick. Scroll to a message, and press the joystick.

To retrieve e-mail messages to your device, select **Options** > **Retrieve e-mail** > **New** to retrieve new messages that you have neither read nor retrieved, **Selected** to retrieve only messages you select from the remote mailbox, or **All** to retrieve all messages not previously retrieved.

To disconnect from a remote mailbox, select **Options** > **Disconnect**.

View e-mail offline

Working offline means that your device is not connected to a remote mailbox. Managing your e-mail offline enables you to save in connection costs and work in conditions that do not allow a data connection. Any changes you make in the remote mailbox folders while offline take effect in your remote mailbox the next time you go online and synchronize. For example, if you delete an e-mail from your device when offline, the e-mail is deleted from the remote mailbox the next time you connect to the mailbox.

1. Select **Message** > **Options** > **Settings** > **E-mail**. Select the e-mail account, and press the joystick. Select **Retrieval settings** > **E-mail to retrieve** > **Msgs. & attachs.** to retrieve entire messages with their attachments to your device.
2. Open your mailbox, and select **Options** > **Retrieve e-mail**. Select **New** to retrieve new messages that you have neither read nor retrieved, **Selected** to retrieve only messages you select from the remote mailbox, or **All** to retrieve all messages not previously retrieved. The device goes online and connects to the mailbox to retrieve the mails.
3. After retrieving the e-mails, select **Options** > **Disconnect** to return to the offline mode.
4. To view an e-mail message, scroll to it, and press the joystick.

Some options require you to connect to your remote mailbox.



Tip: To subscribe to other folders in your remote mailbox, select **E-mail settings** > **Retrieval settings** > **Folder subscriptions**. E-mail in all subscribed folders is updated when you retrieve e-mail from your remote mailbox.

Read and reply to e-mail



Important: E-mail messages may contain viruses or otherwise be harmful to your device or PC. Do not open any attachment if you are not sure of the trustworthiness of the sender.

To read a received e-mail, scroll to the e-mail, and press the joystick.

To search for an e-mail in your mailbox, select **Options** > **Find**. Enter the search term, and select **OK**.

To open an attachment, select **Options** > **Attachments**. Scroll to the attachment, and press the joystick.

To reply only to the sender of an e-mail, open the e-mail, and select **Options** > **Reply** > **To sender**.

To reply to all recipients of an e-mail, open the e-mail, and select **Options** > **Reply** > **To all**.

To delete an attachment from an e-mail that you are sending, select the attachment and **Options** > **Attachments** > **Remove**.



Tip: If you reply to an e-mail that contains attached files, the attachments are not included in the reply. If you forward the received e-mail, attachments are included.

To set the message priority, select **Options** > **Sending options** > **Priority** and from the available options.

To call the sender of the e-mail, open the e-mail, and select **Options** > **Call**.

To reply to the sender of the e-mail with a text message or multimedia message, open the e-mail, and select **Options** > **Create message**.

To forward an e-mail, open the e-mail, and select **Options** > **Forward**.

Delete messages

To free up memory space on your device, regularly delete messages from the **Inbox** and **Sent** folders, and delete retrieved e-mail messages.

To delete a message, scroll to it, and press the clear key.

You can select to delete local e-mail messages on the device and keep the original on the server, or you can delete both the local e-mail messages on the device and the original messages on the server.

To delete e-mails from the device only, select **Options** > **Delete** > **Phone only**.

To delete e-mail both from the device and from the remote server, open an e-mail, and select **Options** > **Delete** > **Phone and server**.

E-mail folders

If you create subfolders in your IMAP4 mailboxes on a remote server, you can view and manage these folders with your device. You can only subscribe to folders in your IMAP4 mailboxes. Subscribing to folders in a remote mailbox allows you to view those folders on your device.

To view folders in your IMAP4 mailbox, establish a connection, and select **Options** > **E-mail sett.** > **Retrieval settings** > **Folder subscriptions**.

To view a remote folder, select a folder and **Options** > **Subscribe**. Every time you go online, the subscribed folders are updated. This may take some time if the folders are large.

To update the list of folders, select a folder and **Options** > **Update folder list**.

Write and send e-mail

To write an e-mail, select **Options** > **Add recipient** to select the recipients' e-mail addresses from the contacts list, or enter the e-mail addresses in the **To** field. Use a semicolon to separate entries. Scroll down, and use the **Cc** field to copy other recipients, or the **Bcc** field to blind copy recipients. In the **Subject** field, enter the subject of the e-mail. Enter your e-mail message in the text area, and select **Options** > **Send**.

To attach a file to an e-mail, select **Options** > **Insert**, and select the attachment you want to add. For example, you can insert images, sound clips, notes and other files such as office files.

To set the sending time for an e-mail message, select **Options** > **Sending options** > **Send message**. Select **Immediately** or **During next conn.** if you are working offline.

E-mail messages are stored in the **Outbox** before sending. Unless the e-mail is sent immediately, you can open the **Outbox** and suspend and resume sending or view the e-mail.

E-mail account settings

Select **Menu** > **Messag.** > **Mailbox**.

The settings available for editing may vary. Some settings may be preset by your service provider.

If you try to edit mailbox settings but have not set up an e-mail account, the mailbox guide opens and helps you set up your e-mail account.

Settings for the received e-mail

Select **Incoming e-mail** and from the following settings:

- **User name** — Enter the user name for the e-mail service.
- **Password** — Enter the password for the e-mail service.
- **Incoming mail serv.** — Enter the IP address or host name of the server that receives your e-mail.
- **Access point in use** — Select the Internet access point that the device uses for retrieving the e-mail messages that you receive.
- **Default mailbox** — Enter a name for the mailbox.
- **Mailbox type** — Select the mailbox protocol that your remote mailbox service provider recommends. The options are **POP3** and **IMAP4**. This setting can be selected only once and cannot be changed if you have saved or exited from the mailbox settings. If you use the POP3 protocol, e-mail messages are not updated automatically when you are online. To see the latest e-mail messages, you must disconnect and make a new connection to your mailbox.
- **Security (ports)** — Select the security option used to increase the security of the connection.
- **Port** — Define a port for connection.
- **APOP secure login** (for POP3 only) — Use with the POP3 protocol to encrypt the sending of passwords to the remote e-mail server while connecting to the mailbox.

Settings for sent e-mail

Select **Outgoing e-mail** and from the following settings:

- **My e-mail address** — Enter the e-mail address given to you by your service provider. Replies to your messages are sent to this address.
- **User name** — Enter the user name for the e-mail service.
- **Password** — Enter the password for the e-mail service.
- **Outgoing mail serv.** — Enter the IP address or host name of the mail server that sends your e-mail. You may only be able to use the outgoing server of your network operator. Contact your service provider for more information.
- **Access point in use** — Select the Internet access point that the device uses for sending the e-mail messages that you send.
- **Security (ports)** — Select the security option used to secure the connection to the remote mailbox.
- **Port** — Define a port for connection.

User settings

Select **User settings** and from the following settings:

- **My name** — Enter a name to appear before your e-mail address when you send e-mail.
- **Reply-to** — Select whether you want replies to be redirected to a different address. Select **On**, and enter the e-mail address to which you want to direct the replies. You can only enter one address to which replies are directed.
- **Delete e-mails from** — Select whether you want to delete the e-mails only from the device or from both the device and the server. Select **Always ask** if you want to confirm from where the e-mail should be deleted every time you delete an e-mail.
- **Send message** — Select to send the e-mail as soon as possible, to send it the next time you retrieve e-mail,

or to store the e-mail in the Outbox, from where you can send it later.

- **Send copy to self** — Select whether you want to save a copy of the e-mail to your remote mailbox and to the address defined in **My e-mail address** in the settings for **Outgoing e-mail**.
- **Include signature** — Select whether you want to attach a signature to your e-mail messages.
- **New e-mail alerts** — Select whether you want to receive the new e-mail indications, a tone and a note, when new mail is received to the mailbox.
- **Default encoding** — Select the preferred method for character encoding.

Retrieval settings

Select **Retrieval settings** and from the following settings:

- **E-mail to retrieve** (for POP3 mailboxes only) — Select whether you want to retrieve only the e-mail header information such as sender, subject and date, e-mail, or e-mail with attachments.
- **Retrieval amount** — Select the number of e-mails you want to retrieve from the remote server to your mailbox.
- **IMAP4 folder path** (for IMAP4 mailboxes only) — Define the folder path for folders to be subscribed.
- **Folder subscriptions** (for IMAP4 mailboxes only) — Subscribe to other folders in the remote mailbox and retrieve content from those folders.

Automatic retrieval settings

Select **Automatic retrieval** and from the following settings:

- **E-mail notifications** — Select whether you want to receive notifications when new e-mail is received in your remote mailbox. Select **Always enabled** to always automatically retrieve new e-mail messages from your remote mailbox, or **Only in home net.** to automatically retrieve new e-mail messages from your remote mailbox only when you are in your home network and not, for example, traveling.
- **Retrieval days** — Select the days on which e-mails are retrieved to your device.
- **Retrieval hours** — Define the hours between which the e-mails are retrieved.
- **Retrieval interval** — Select the time interval between retrieving new e-mails.

Instant messaging

Select **Menu** > **Connect.** > **IM.**

Instant messaging (IM) (network service) allows you to converse with other people using instant messages and join discussion forums (IM groups) with specific topics. Various service providers maintain IM servers that you can log in to after you register to an IM service. Service providers may differ in their support of features.

If IM is not available from your wireless service provider, it may not appear in the menu of your device. Contact your service provider for more information about signing up for IM services and costs for services. For more information on the availability of IM settings, contact your network operator, service provider, or dealer.

You may receive the settings in a special text message from the network operator or service provider that offers the IM service. You must save the settings to access the

service that you want to use. You can also enter the settings manually.

Connect to an IM server

To converse with an IM user or users, and to view and edit your IM contacts, you must log into the instant messaging server. Open **IM,** and select **Options** > **Login.** Enter your user ID and password, and press the joystick to log in. You can obtain the user name, password, and other settings to log in from your service provider when you register for the service.

Search IM users or IM groups

To search for IM users and user IDs, select **IM contacts** > **Options** > **New IM contact** > **Search.** You can search by **User's name, User ID, Phone number,** and **E-mail address.**

To search for IM groups and group IDs, select **IM groups** > **Options** > **Search.** You can search by **Group name, Topic,** and **Members** (user ID).

Conversations with a single IM user

The **Conversations** view shows a list of the individual conversation participants with whom you have an ongoing conversation. Ongoing conversations are automatically closed when you exit IM.

To view a conversation, scroll to a participant, and press the joystick.

To continue the conversation, enter your message, and press the joystick.

To return to the conversations list without closing the conversation, select **Back**. To close the conversation, select **Options** > **End conversation**.

To start a new conversation, select **Options** > **New conversation**. You can start a new conversation with a different contact while you are inside another active conversation. However, you cannot have two active conversations with the same contact.

To insert an image to an instant message, select **Options** > **Send image**, and select the image you want to send.

To save a conversation participant to your IM contacts, select **Options** > **Add to IM contacts**.

To save a conversation, while in the conversation view, select **Options** > **Record chat**. The conversation is saved as a text file that can be opened and viewed in the **Notes** application.

To send automatic replies to incoming messages, select **Options** > **Set auto reply on**. You can still receive messages.

IM groups

The **IM groups** view shows a list of the IM groups that you have saved or to which you are currently joined.

IM groups is available only if you logged into an IM server when you opened the IM application, and the server supports IM groups.

To create an IM group, select **Options** > **Create new group**.

To join an IM group or to continue a group conversation, scroll to the group, and press the joystick. Enter a message, and press the call key to send it.

To join an IM group that is not on the list, but for which you know the group ID, select **Options** > **Join new group**.

To leave the IM group, select **Options** > **Leave IM group**.

To remove an IM group, press the clear key.

Ban from groups

Scroll to the IM group, and select **Options** > **Group** > **Settings** > **Banned list**.

To prevent IM users from joining the group, select **Options** > **Add to banned list** and from the following:

- **From IM contacts** — Ban one or several of your IM contacts.
- **Enter user ID** — Enter the ID of the IM user.

To allow a banned user to join the group, select **Options** > **Remove**.

IM contacts

When login to an IM service is complete, your contact list for the service provider is retrieved automatically. If your contact list is not available, wait a few minutes and try to retrieve your contacts list manually.



Tip: The online status of your IM contacts is shown by an indicator next to the contact name.

To create an IM contact card, select **Options** > **New IM contact**. Enter the user ID and a nickname, and select **Done**. The user ID can be up to 50 characters, and the IM

service provider may require the user ID to be in the username@domain.com format. The nickname is optional.

To view a different list of your IM contacts, select **Options** > **Change contact list**.

Scroll to an IM contact, select **Options** and from the following:

- **Open conversation** — Start or continue instant messaging with the contact.
- **Contact details** — View the contact card.
- **Editing options** — Edit or delete the contact card, move it to another contact list, or receive a note when the contact's online status changes.
- **Belongs to groups** — See the IM groups the contact has joined.
- **New contact list** — Create a contact list for a specific group of IM contacts.
- **Reload users' availab.** — Update the online status of your IM contacts.
- **Blocking options** — Prevent or allow the reception of messages from the contact.
- **Login** — Connect to an instant messaging server if you did not log in when you opened the application.
- **Logout** — Disconnect from the IM server.
- **Settings** — Edit instant messaging application or server settings.

The available options may vary.

To delete an IM contact, press the clear key.

Blocked contacts

Select **IM contacts** > **Options** > **Blocking options** > **View blocked list**.

To find a blocked IM user, enter the first letters of the user's name. Matching names appear in a list.

To allow receiving messages from a blocked IM user, select **Options** > **Unblock**.

To prevent receiving messages from other IM users, select **Options** > **Block new contacts**. Select the IM user from your IM contacts, or enter the user ID.

Settings

Select **Options** > **Settings** > **IM settings**.

Select from the following settings:

- **Use screen name** — To change the name that identifies you in IM groups, select **Yes**.
- **Allow messages from** — Select to receive instant messages from all other IM users, your IM contacts only, or not to receive messages at all.
- **Allow invitations from** — Select to receive invitations to IM groups from all IM users, your IM contacts only, or not to receive invitations at all.
- **Msg. scrolling speed** — To decrease or increase the speed at which new messages are displayed, scroll left or right.
- **Sort IM contacts** — Select to list your IM contacts alphabetically or by their online status.
- **Availabil. reloading** — To update the online status of your IM contacts automatically, select **Automatic**.
- **Offline contacts** — Select if IM contacts with an offline status are shown in the IM contacts list.

The settings available for editing may vary. Contact your service provider for more information.

IM server settings

Select **Options** > **Settings** > **Server settings**.

Scroll to the following options, and press the joystick to configure your IM server:

- **Servers** — Add new, edit, or delete servers.
- **Default server** — Change the server to which your device automatically logs into, scroll to the desired server, and press the joystick.
- **IM login type** — To establish a connection between your device and the default server automatically, select **Automatic**. Select **Aut. in home net.** to automate the connection when in your home network. Select **On app. start-up** to connect to the server when you open the messaging application. Select **Manual** to connect to the server manually at any time.

Special messages

Your device can receive many kinds of messages that contain data:

- **Operator logo** — To save the logo, select **Options** > **Save**.
- **Ringing tone** — To save a ring tone, select **Options** > **Save**.
- **Configuration message** — You may receive settings from your network operator, service provider, or company information management department in a configuration message. To accept the settings, open the message, and select **Options** > **Save all**.
- **E-mail notification** — The note tells you how many new e-mails you have in your remote mailbox. An

extended notification may list more detailed information.

Send service commands

Send a service request message to your service provider and request activation for certain network services.

To send a service request to your service provider, select **Options** > **Service command**. Enter the service request as a text message, and select **Options** > **Send**.

Connectivity

Copyright protections may prevent some images, music (including ringing tones), and other content from being copied, modified, transferred or forwarded.

Your device offers several options to connect to the Internet, a corporate intranet, or to another device or PC. Wireless methods include wireless LAN, Bluetooth, and infrared. Your device supports a wired solution with a USB (Universal Serial Bus) cable connection for Nokia PC Suite or IP passthrough. Your device also allows you to communicate using net calls (Voice over IP), push to talk, instant messaging (chat), and modem-based connections.

Internet access points

An access point is where your device connects to a network. To use e-mail and multimedia services or to connect to the Internet and browse web pages, you must first define Internet access points for these services. You may need to set up several Internet access points, depending on the sites you want to access. For example, browsing the Web may require one access point, and accessing your company intranet may require another. To connect to the Internet over GPRS, your device may have predefined, default Internet access point settings.

When you switch on your device for the first time, the access points may be configured automatically based on the service provider information in your SIM card. You can also receive the access points settings in a message from

your service provider. This might reduce the number of settings you need to enter yourself.

The available options may vary. Some or all access points may be preset for your device by your service provider.

You may not be able to add, edit, or delete access points.

Contact your service provider and e-mail service provider for more information on access points and their settings.

See "Connection settings," p. 84.

Set up an Internet access point for packet data (GPRS)

1. Select **Menu > Tools > Settings > Connection > Access points**.
2. Select **Options > New access point**. To use an existing access point as a basis for the new one, select **Use existing settings**. To start with an empty access point, select **Use default settings**.
3. Define the following settings.
 - **Connection name** — Enter a descriptive name for the connection.
 - **Data bearer** — Select **Packet data**.
 - **Access point name** — Enter the name for the access point. The name is usually provided by your service provider or network operator.

- **User name** — Enter your user name if required by the service provider. User names are often case-sensitive and provided by your service provider.
 - **Prompt password** — Select **Yes** to enter your password each time you log into a server or **No** to save the password in your device memory and automate the login.
 - **Password** — Enter your password if required by the service provider. The password is often case-sensitive provided by the service provider.
 - **Authentication** — Select **Secure** to always send your password encrypted or **Normal** to send your password encrypted when possible.
 - **Homepage** — Enter the Web address of the page you want to display as a home page when you use this access point.
4. After defining the settings, select **Options** > **Advanced settings** to define the advanced settings or **Back** to save the settings and exit.

For information on the advanced settings, see the extended user guide on the Web.

Set up an Internet access point for wireless LAN

1. Select **Menu** > **Tools** > **Settings** > **Connection** > **Access points**.
2. Select **Options** > **New access point**. To use an existing access point as a basis for the new one, select **Use existing settings**. To start with an empty access point, select **Use default settings**.
3. Define the following settings.

- **Connection name** — Enter a descriptive name for the connection.
- **Data bearer** — Select **Wireless LAN**.
- **WLAN netw. name** — To enter the service set identifier (SSID), that is, the name that identifies the specific wireless LAN, select **Enter manually**. To select the network from the wireless LANs in range, select **Search for netw.**
- **Network status** — Select **Hidden** if the network you are connecting to is hidden, or **Public** if it is not hidden.
- **WLAN netw. mode** — If you select **Infrastructure**, devices can communicate with each other and with wired LAN devices through a wireless LAN access point. If you select **Ad-hoc**, devices can send and receive data directly with each other, and no wireless LAN access point is needed.
- **WLAN security mode** — You must select the same security mode that is used in the wireless LAN access point. If you select WEP (wired equivalent privacy), 802.1x, or WPA (Wi-Fi protected access), you must also configure the relevant additional settings. See the extended user guide on the Web or the device help for more information.
- **WLAN security sett.** — Edit the security settings for the selected **WLAN security mode**.
- **Homepage** — Enter the Web address of the page you want to display as a home page when you use this access point.

The settings available for editing may vary.

Cable connection

Install the USB data cable driver to your PC before you use a cable connection. You can use the [Data transfer](#) without installing the USB data cable drivers.

Select [Menu](#) > [Connect](#). > [Data cbl.](#)

Using a USB data cable, you can connect your device to a compatible PC. Connect the USB data cable to the bottom of the device. To change the device type you normally connect to your device with the data cable, press the joystick.

Select from the following:

- [Ask on connection](#) — Select whether you want to be asked for the device type every time you connect the data cable to your device.
- [PC Suite](#) — Connect the PC Suite to your device with the data cable, and use your device as a modem.
- [Data transfer](#) — Access and transfer data such as music or image files from your computer using the data cable connection. To use the [Data transfer](#) mode, make sure that you have not selected USB as a connection type in the Manage connections settings in Nokia PC Suite. Insert a memory card to your device, connect the device to a compatible computer with the USB data cable, and select [Data transfer](#) when the device asks which mode is used. In this mode, your device acts as a mass storage device and you can see it as a removable hard drive in your computer. The device will switch into the [Offline](#) profile if this is selected. End the connection from the PC (for example, from an Unplug or Eject Hardware wizard in Windows) to avoid damaging the memory card. After you end the

connection, the device returns to the profile in which it was before using the data transfer mode.

- [IP passthrough](#) — Select an access point through which to transfer data using the Internet protocol.

To save your selection, select [Back](#).

Bluetooth

There may be restrictions on using Bluetooth technology in some locations. Check with your local authorities or service provider.

Features using Bluetooth technology, or allowing such features to run in the background while using other features, increase the demand on battery power and reduces the battery life.

This device is compliant with Bluetooth Specification 1.2 supporting the following profiles: Generic Access Profile, Serial Port Profile, Dial-up Networking Profile, Headset Profile, Handsfree Profile, Generic Object Exchange Profile, Object Push Profile, File Transfer Profile, SIM Access Profile, and Basic Imaging Profile. To ensure interoperability between other devices supporting Bluetooth technology, use Nokia approved enhancements for this model. Check with the manufacturers of other devices to determine their compatibility with this device.

Bluetooth technology enables wireless connections between electronic devices within a range of 10 meters (33 feet). A Bluetooth connection can be used to send images, videos, texts, business cards, calendar notes, or to connect wirelessly to devices using Bluetooth technology, such as computers.

Since devices using Bluetooth technology communicate using radio waves, your device and the other devices do not need to be in direct line-of-sight. The two devices only need to be within a maximum of 10 meters of each other, although the connection can be subject to interference from obstructions such as walls or from other electronic devices.

Start using Bluetooth

Select **Menu** > **Connect** > **Bluetooth**.

1. When you activate Bluetooth for the first time, you are asked to give a name to your device. Give your device a unique name to make it easy to recognize if there are several Bluetooth devices in the vicinity.
2. Select **Bluetooth** > **On**.
3. Select **My phone's visibility** > **Shown to all**.

Your device and the name you entered can now be seen by other users with devices using Bluetooth technology.

Settings

Define the following settings:

- **Bluetooth** — Select **On** to be able to connect to another compatible device using Bluetooth connectivity.
- **My phone's visibility** — Select **Shown to all** to allow other devices using Bluetooth technology to find your device when you have set **Bluetooth** > **On**. To prevent other devices from finding your device, select **Hidden**. Even if you select **Hidden**, paired devices can still detect your device.

- **My phone's name** — Enter a name for your device. The name is visible to other devices that search for devices using Bluetooth technology. The maximum length of the name is 30 characters.
- **Remote SIM mode** — Select **On** to enable another device, such as a compatible car kit enhancement, to use the SIM card in your device to connect to the network. See "SIM access profile," p. 59.

If Bluetooth was turned off as a result of entering **Offline** profile, you must re-enable Bluetooth manually.

Security tips

When you are not using Bluetooth connectivity, select **Bluetooth** > **Off** or **My phone's visibility** > **Hidden**.

Do not pair with an unknown device.

Send data

Several Bluetooth connections can be active at a time. For example, if you are connected to a headset, you can also transfer files to another compatible device at the same time.

1. Open the application where the item you want to send is stored.
2. Select the item, and select **Options** > **Send** > **Via Bluetooth**. The device searches for other devices using Bluetooth technology within range and lists them.





Tip: If you have sent data using Bluetooth before, a list of the previous search results is displayed. To search for more Bluetooth devices, select **More devices**.

3. Select the device with which you want to connect, and press the joystick to set up the connection. If the other device requires pairing before data can be transmitted, you are asked to enter a passcode.
4. When the connection has been established, **Sending data** is shown.

The **Sent** folder in **Message** does not store messages sent using Bluetooth connectivity.

Bluetooth connectivity indicators

 Bluetooth is active.

 When the icon is blinking, your device is trying to connect to the other device. When the icon is shown continuously, the Bluetooth connection is active.

Pair devices

Select **Menu** > **Connect** > **Bluetooth**, and scroll right to open the **Paired devices** page.

Before pairing, create your own passcode (1-16 digits), and agree with the user of the other device to use the same code. Devices that do not have a user interface have a fixed passcode. You need the passcode only when you connect the devices for the first time. After pairing, it is possible to authorize the connection. See "Authorize a device," p. 58. Pairing and authorizing the connection makes connecting quicker and easier, as you do not have to accept a connection between paired devices every time you establish the connection.

The passcode for remote SIM access must have 16 digits.

1. Select **Options** > **New paired device**. The device starts to search for Bluetooth devices within range.



Tip: If you have sent data using Bluetooth before, a list of the previous search results is displayed. To search for more Bluetooth devices, select **More devices**.

2. Select the device with which you want to pair, and enter the passcode. The same passcode must be entered to the other device as well.
3. Select **Yes** to make the connection between your device and the other device automatic or **No** to confirm the connection manually every time a connection attempt is made. After pairing, the device is saved to the paired devices page.

To give a nickname to a paired device that is only displayed in your device, scroll to the device with which you have paired, and select **Options** > **Assign short name**.

To delete a pairing, select the device whose pairing you want to delete and **Options** > **Delete**. To delete all pairings, select **Options** > **Delete all**.



Tip: If you are currently connected to a device and cancel the pairing with that device, pairing is removed immediately, and the connection is switched off.

Authorize a device

If you trust a paired device, you can allow it to connect automatically to your device. You can select from the following options:

- **Set as authorised** — Connections between your device and the other device can be made without your

knowledge. No separate acceptance or authorization is needed. Use this status for your own devices, such as your compatible headset or PC, or devices that belong to someone you trust.

- **Set as unauthorised** — Connection requests from the other device must be accepted separately every time.

Receive data

If you want to receive data using Bluetooth, select **Bluetooth > On** and **My phone's visibility > Shown to all**. When you receive data through Bluetooth connectivity, a tone sounds, and you are asked if you want to accept the message. If you accept, the message is placed in the **Inbox** folder in **Messag**.



Tip: You can access the files in the device or on the memory card using a compatible accessory that supports the File Transfer Profile Client service (for example, a laptop computer).

SIM access profile

When the wireless device is in the remote SIM mode, you can only use a compatible connected enhancement, such as a car kit, to make or receive calls. Your wireless device will not make any calls, except to the emergency numbers programmed into your device, while in this mode. To make calls from your device, you must first leave the remote SIM mode. If the device has been locked, enter the code to unlock it first.

With the SIM access profile, you can access the SIM card of your device from a compatible car kit device. This way,

you do not need a separate SIM card to access SIM card data and connect to the GSM network.

To use the SIM access profile, you need the following:

- Compatible car kit device that supports Bluetooth wireless technology
- Valid SIM card in your device

For more information about car kit devices and compatibility with your device, see www.nokia.com and your car kit user guide.

Manage the SIM access profile

1. Select **Menu > Connect. > Bluetooth** to activate Bluetooth connectivity in your device.
2. To enable remote SIM access, scroll to **Remote SIM mode**, and press the joystick.
3. Activate Bluetooth in the car kit device.
4. Use your car kit device to start a search for compatible devices. For instructions, see the user guide of your car kit device.
5. Select your device from the list of compatible devices.
6. To pair the devices, enter the Bluetooth passcode shown on the display of the car kit device to your device.
7. Authorize the car kit device. Select **Menu > Connect. > Bluetooth**, and scroll to the **Paired devices** page. Scroll to the car kit device, and enter the Bluetooth passcode. When the device asks to make the connection automatic, select **Yes**. Connections between your device and the car kit device can be made without separate acceptance or authorization. If you select **No**, connection requests from this device must be accepted separately every time.



Tip: If you have already accessed the SIM card from the car kit with the active user profile, the car kit searches automatically for a device with the SIM card. If it finds your device, and automatic authorization is activated, the car device automatically connects to the GSM network when you switch on the car ignition.

When you activate the remote SIM access profile, you can use applications on your device that do not need network or SIM services.

To end the remote SIM access connection from your device, select **Menu > Connect. > Bluetooth > Remote SIM mode > Off.**

Infrared

Do not point the IR (infrared) beam at anyone's eye or allow it to interfere with other IR devices. This device is a Class 1 laser product.

Use infrared to connect two devices and transfer data between them. With infrared, you can transfer data such as business cards, calendar notes, and media files with a compatible device.

Send and receive data

1. Ensure that the infrared ports of the devices face each other. The positioning of the devices is more important than angle or distance.
2. Select **Menu > Connect. > Infrared**, and press the joystick to turn on infrared on your device. Turn on infrared on the other device.

3. Wait a few seconds until an infrared connection is established.
4. To send, locate the desired file in an application or the file manager, and select **Options > Send > Via infrared.**

If data transfer is not started within 1 minute after the activation of the infrared port, the connection is cancelled and must be started again.

All items received through infrared are placed in the Inbox folder in **Message.**

Positioning devices away from each other breaks a connection, but the infrared light beam remains active on your device until it is deactivated.

Data connections

Packet data

GPRS (general packet radio service) enables wireless access for mobile phones to data networks (network service). GPRS uses packet data technology where information is sent in short bursts of data over the mobile network. The benefit of sending data in packets is that the network is occupied only when sending or receiving data. As GPRS uses the network efficiently, it allows for quick data connection set-up and fast data transmission speeds.

You must subscribe to the GPRS service. For availability and subscription to GPRS, contact your network operator or service provider.

Enhanced GPRS (EGPRS) is similar to GPRS, but it enables faster connection. For more information on the availability of EGPRS and data transfer speed, contact your network operator or service provider. Note that when you have selected GPRS as a data bearer, the device uses EGPRS instead of GPRS if this is available in the network.

During a voice call, you cannot establish a GPRS connection, and any existing GPRS connection is put on hold unless the network supports dual transfer mode.

UMTS

UMTS (universal mobile telecommunications system) is 3G mobile communication system. Besides voice and data, UMTS enables audio and video delivery to wireless devices.

Your device can automatically switch between the GSM and UMTS networks.

To select which network to use, select **Menu > Tools > Settings > Network** and the network in **Network mode**. If you want the device to switch between the networks automatically, select **Dual mode**.

The GSM network is indicated with , the UMTS network with **3G**.

When you use your device in GSM and UMTS networks, multiple data connections can be active at the same time, and access points can share a data connection. In the UMTS network, data connections remain active during voice calls. You can, for example, surf the Web faster than previously possible while simultaneously speaking on the phone.

Wireless local area network (WLAN)

Some places, like France, have restrictions on the use of wireless LAN. Check with your local authorities for more information.

Features using wireless LAN, or allowing such features to run in the background while using other features, increase the demand on battery power and reduce the battery life.

This device can detect and connect to a wireless local area network.

If you move the device to another location within the wireless LAN and out of range of a wireless LAN access point, the roaming functionality can automatically connect your device to another access point that belongs to the same network. As long as you remain within range of access points that belong to the same network, your device can stay connected to the network.



Tip: A wireless LAN connection is established when you create a data connection using a wireless LAN Internet access point. The active wireless LAN connection is ended when you end the data connection.

Your device enables different types of communication in a wireless LAN. The two operating modes are infrastructure and ad hoc.

- The infrastructure operating mode allows two kinds of communication: wireless devices communicate with each other through a wireless LAN access point or wireless devices communicate with a wired LAN device through a wireless LAN access point. The advantage of the infrastructure operating mode is that you can have

more control over network connections because they pass through an access point. A wireless device can access the services that are available in a regular wired LAN: company database, e-mail, the Internet, and other network resources, for example.

- In the ad hoc operating mode you can send data to and receive it from other devices with compatible wireless LAN support, for example, to be printed. These functions may require an additional third party application to work. No wireless LAN access point is required. Simply make the necessary configurations and start communicating. Ad hoc networking is easy to set up, but communication is limited to devices that are within range and support compatible wireless LAN technology.

Connection manager

Select **Menu** > **Connect.** > **Conn mgr.**

To view the status of data connections or end connections, select **Act. data conn.**

To search for wireless LANs available within range, select **Availab. WLAN.**

View and end active connections



Note: The actual time invoiced for calls by your service provider may vary, depending on network features, rounding off for billing, and so forth.

In the active connections view, you can see the open data connections: data calls, packet data connections, and wireless LAN connections.

To view detailed information about network connections, select the connection from the list and **Options** > **Details.** The type of information shown depends on the connection type.

To end a network connection, select the connection from the list and **Options** > **Disconnect.**

To end all active network connections simultaneously, select **Options** > **Disconnect all.**

To view the details of a network, press the joystick.

Search for wireless LAN

To search for wireless LANs available within range, select **Menu** > **Connect.** > **Conn mgr** > **Availab. WLAN.** A list of found networks is displayed.

The available wireless LAN view shows a list of wireless LANs within range, their network mode (infrastructure or ad-hoc), signal strength indicator and network encryption indicators, and if your device has an active connection with the network.

To view the details of a network, press the joystick.

To create an Internet access point in a network, select **Options** > **Define access point.**

Modem

Select **Menu** > **Connect.** > **Modem.**

Together with a compatible computer, you can use your device as a modem to connect to the Web.

Before you can use your device as a modem

- You need the appropriate data communications software on your computer.
- You must subscribe to the appropriate network services from your service provider or Internet service provider.
- You must have the appropriate drivers installed on your computer. You must install drivers for your cable connection, and you may need to install or update Bluetooth or infrared drivers.

To connect the device to a compatible computer using infrared, press the joystick. Make sure the infrared ports of the device and computer are directly facing each other with no obstacles between them.

To connect your device to a computer using Bluetooth wireless technology, initiate the connection from the computer. To activate Bluetooth in your device, select **Menu** > **Connect** > **Bluetooth** and select **Bluetooth** > **On**.

If you use a cable to connect your device to a computer, initiate the connection from the computer.

Note that you may not be able to use some of the other communication features when the device is used as a modem.

Mobile VPN

Select **Menu** > **Tools** > **Settings** > **Connection** > **VPN**.

The Nokia mobile virtual private network (VPN) client creates a secure connection to compatible corporate Intranet and services, such as e-mail. Your device connects from a mobile network, through the Internet, to a corporate VPN gateway that acts as a front door to the compatible corporate network. VPN client uses IP Security (IPSec) technology. IPSec is a framework of open standards for supporting secure exchange of data over IP networks.

VPN policies define the method used by VPN client and a VPN gateway to authenticate each other, and the encryption algorithms that they use to help protect the confidentiality of data. Contact your corporation for a VPN policy.

To use VPN with an application, the application must be associated with a VPN access point. A VPN access point is made up of an Internet access point and a VPN policy.

To manage VPN, select **VPN management** > **Options** > **Open** and from the following options:

- **VPN policy** — Install, view, and update VPN policies.
- **VPN policy servers** — Edit the connection settings of VPN policy servers from which you can install and update VPN policies.
- **VPN log** — View the log for your VPN policy installations, updates and synchronizations, and other VPN connections.

Email data roaming

Select **Menu** > **Tools** > **Settings** > **Connection** > **Access point groups**.

Your device allows roaming between wireless access technologies, such as WLAN and GPRS, for e-mail. For example, you can start an e-mail session at home and continue the session on your way to work. While your session continues uninterrupted, your handheld device switches from WLAN to GPRS and back to WLAN when you arrive at your workplace.

Access point groups

To create an access point group, select [Access point groups](#) > [Options](#) > [New group](#). In the [Group name](#) field, enter a name for the group. Define in the [Conn. switching](#) field whether to show the connection switching process on the display of your device. Choose and edit the access points that belong to this group in the [Access points](#) section.

To remove an access point in an access point group, select the access point and [Options](#) > [Remove](#).

Web

Select **Menu** > **Web** (network service).

Web is one of the two browsers in your device. With **Web**, you can browse regular Web sites. These pages use the extensible hypertext markup language (XHTML) or hypertext markup language (HTML). If you want to browse WAP pages, use **Menu** > **Media** > **Services**. Both of the browsers use the same bookmarks. The links in your received messages open in the **Services** browser.

Check the availability of services, pricing, and fees with your network operator or service provider. Service providers will also give you instructions on how to use their services.

Access points

To browse the Web, you need to configure Internet access point settings. If you are using a data call or a GPRS connection, your wireless network must support data calls or GPRS, and the data service must be activated for your SIM card. Your device might have configured the Internet access point settings automatically based on your SIM card. If not, contact your service provider for the correct settings.



Tip: You may receive the Internet access point settings from your service provider as a special text message or from the network operator's or service provider's Web pages.

You can also enter the Internet access point settings manually. See "Internet access points," p. 54.

Browse the Web

Use the joystick for browsing. The joystick is shown as a pointer on a Web page, and you can scroll the pages up, down, left and right with it. When you move the pointer over a link, the pointer changes into a hand. Press the joystick to open the link.

To browse the Web, select a bookmark, and press the joystick. You can also enter the Web address, and press the joystick. Use only services that you trust and that offer adequate security and protection against harmful software.



Tip: When you start to enter the address, addresses of pages you have previously visited that match your input are displayed. To open a page, scroll to the address, and press the joystick.

To open a Web link, scroll to it and press the joystick. On a Web page, new links appear underlined in blue and previously visited links in purple. Images that act as links have a blue border around them.

Addresses of the pages you visit are saved in the **Auto. bookmarks** folder.

Keyboard shortcuts:

- Press **1** to open your **Bookmarks**.

- press **2** to find text.
- Press **3** to return to the previous page.
- Press **6** to switch between your open browser windows.
- Press **7** to enable or disable page overview.
- Press **8** to open page overview.
- Press **9** to go to a different Web page.

Bookmarks

Your device may have some bookmarks loaded for sites not affiliated with Nokia. Nokia does not warrant or endorse these sites. If you choose to access them, you should take the same precautions, for security or content, as you would with any Internet site.

To view a bookmarked Web page, scroll to the bookmark, and press the joystick.

To browse another Web pages, select **Options** > **Navigation options** > **Go to web address**, enter the page address, and select **Go to**.

To delete a bookmark, scroll to it, and press the clear key.

To add a bookmark, select **Menu** > **Web** > **Options** > **Bookmark manager** > **Add bookmark**. Scroll to **Name** to enter a descriptive name for the bookmark, **Address** to enter the Web page address, **Access point** to change the access point to connect to the Web page, and **User name** or **Password** to enter your user name and password, if required by the service provider. To save the bookmark, select **Back**.



Tip: You can also add bookmarks while browsing. Select **Options** > **Save to bookmarks**.

Download items



Important: Only install and use applications and other software from sources that offer adequate security and protection against harmful software.

You can download different items such as ringing tones, images, operator logos, themes, and video clips. To download an item, scroll to it, and press the joystick. These items can be provided free, or you can purchase them. Downloaded items are handled by the respective applications in your device.

When you start a download, a list of ongoing, paused, and completed downloads from the current browsing session is displayed. To view the list, you can also select **Options** > **Tools** > **Downloads**. In the list, scroll to an item, and select **Options** to pause, resume, or cancel ongoing downloads; or open, save, or delete completed downloads.

To purchase items:

1. To download the item, scroll to the link, and press the joystick.
2. Select the appropriate option to purchase the item.
3. Carefully read all the information provided. To continue the download, select **Accept**. To cancel the download, select **Cancel**.

End a connection

To end the connection and view the browser page offline, select **Options** > **Advanced options** > **Disconnect**; or to end the connection and close the browser, select **Options** > **Exit**.

Clear the cache

A cache is a memory location that is used to store data temporarily. If you have tried to access or have accessed confidential information requiring passwords, empty the cache after each use. The information or services you have accessed are stored in the cache.

To clear the cache, select **Options** > **Advanced options** > **Clear cache**.

News feeds and blogs

Select **Menu** > **Web** > **Web feeds**.

Feeds usually contain headlines and articles, often about recent news or other topics.



Tip: Blog is a shortening of Weblog, which is a continuously updated Web diary. Often the author's personality is an important factor in the blog.

To download a feed or blog, scroll to it, and press the joystick.

To add a feed or blog, select **Options** > **Manage feed** > **New feed**, and enter the information.

To edit a feed or blog, scroll to a feed, select **Options** > **Manage feed** > **Edit**, and modify the information.

Web settings

Select **Menu** > **Web** > **Options** > **Settings**.

Define the following settings:

- **Access point** — Scroll to the access point to connect to Web pages, and press the joystick.
- **Load imgs. & sounds** — Select **No** to load pages faster when browsing by not loading the images on them. You can still choose to load images when browsing individual pages. Select **Options** > **Show images**.
- **Font size** — Select the font size that you want to use when viewing the Web pages.
- **Default encoding** — Select the correct character encoding for your language.
- **Auto. bookmarks** — Select **On** to save Web page addresses that you visit automatically in the **Auto. bookmarks** folder. To hide the folder, select **Hide folder**.
- **Screen size** — Select **Full screen** to use the whole display area for viewing Web pages. You can press the left selection key to open **Options** and use the available options while browsing in full screen mode.
- **Homepage** — Select the page that you want to appear as your homepage. Select **Default** to use the access point homepage, **User defined** to enter the homepage address, or **Use current page** to use the currently open Web page.
- **Mini map** — Select whether you want to see an overview of the page as a miniature on top of the page you are viewing.

- **History list** — Select whether you want to see miniatures of the pages you have visited when you want to go back in your browsing history.
- **Cookies** — Select to allow or reject the sending and receiving of cookies. Cookies are info the network server collects about your visits to various Web pages. They are necessary if you shop on the Web (for example, to retain the items you buy until you reach the cashier page). However, the information may be misused (for example, you may receive unwanted advertisements in your device).
- **Java/ECMA script** — Some Web pages may include program commands that affect the appearance of the page or interaction between the page and its browsers. To deny the use of such scripts, select **Disabled** (for example, if you have trouble downloading).
- **Security warnings** — Select **Show** or **Hide** to see or hide the security warnings you may receive during browsing.
- **Block pop-ups** — Select whether you want to allow pop-ups. Some pop-ups may be necessary (for example, smaller windows where you write e-mails in Web-based mail systems), but they may also contain unwanted advertising.

Services

Select **Menu** > **Media** > **Services** (network service).

Services is one of the two browsers in your device. With **Services**, you can browse WAP pages that have been designed specially for mobile devices. For example, operators may have WAP pages for mobile devices. To

browse regular Web pages, use the other browser in **Menu** > **Web**.

Check the availability of services, pricing, and fees with your network operator or service provider. Service providers will also give you instructions on how to use their services.



Tip: To start a connection, press and hold **0** in the standby mode.

Media applications

Copyright protections may prevent some images, music (including ringing tones), and other content from being copied, modified, transferred or forwarded.

Select **Menu** > **Media**.

Media contains different media applications that allow you to save and view images, record sounds, and play sound clips.

Gallery

Select **Menu** > **Media** > **Gallery**.

Use **Gallery** to access and use different types of media, including images, videos, music, and sounds. All viewed images and videos and all received music and sounds are automatically saved to **Gallery**. You can browse, open, and create folders; and mark, copy, and move items to folders. Sound clips are opened in the Music Player, and video clips and streaming links in the RealPlayer application.

To open a file or a folder, press the joystick. Images are opened in the image viewer.

To create a new folder, select **Options** > **Organise** > **New folder**.

To copy or move files, select a file and **Options** > **Organise** > **Move to folder**, **New folder**, **Move to memory card**, **Copy to memory card**, **Copy to phone mem.**, or **Move to phone mem.**

To download files into the **Gallery** in one of the main folders using the browser, select **Graphic downl.**, **Video downl.**, **Track downl.**, or **Sound downl.**. The browser opens, and you can choose a bookmark or enter the address for the site to download from.

To search for a file, select **Options** > **Find**. Start to enter a search string (for example, the name or date of the file you are searching for). Files that match the search are shown.

Images

Select **Menu** > **Media** > **Gallery** > **Images**.

Images consists of two views:

- In the image browser view you can send, organize, delete, and rename images stored in your device or memory card. You can set images as wallpaper for your display.
- In the image viewer, which opens when you select an image in the image browser view, you can view, and send individual images.

The following file formats are supported: JPEG, BMP, PNG, and GIF 87a/89a. The device does not necessarily support all variations of the file formats.

To open an image for viewing, select an image in the image browser view, and select **Options** > **Open**. The image opens in the image viewer.

To open the next or previous image for viewing, scroll right or left in the image viewer.

To enlarge the viewed image on the display, select **Options** > **Zoom in**, or press **5** or **7**. To reduce the viewed image on the display, select **Zoom out** or press **0**.

To view the image in full screen size, select **Options** > **Full screen** or press **7** twice. To return to normal view, select **Options** > **Normal screen**.

To rotate an image, select an image, and **Options** > **Rotate**. Select **Right** to rotate the image clockwise by 90 degrees, or select **Left** to rotate the image counterclockwise by 90 degrees.

Manage image files

Copyright protections may prevent some images, ringing tones, and other content from being copied, modified, transferred or forwarded.

To view detailed information about an image, select an image and **Options** > **View details**. Size and format of the file, the time and date the file was last modified and the resolution of the image in pixels are displayed.

To send an image, select the image, **Options** > **Send**, and the method for sending.

To rename an image, select an image and **Options** > **Rename**. Enter a new name, and select **OK**.

To set an image as wallpaper, select the image and **Options** > **Set as wallpaper**.

To add an image to a contact card, select an image and **Options** > **Assign to contact**. The contacts view opens, and you can select the contact for the image.

RealPlayer

Copyright protections may prevent some images, ringing tones, and other content from being copied, modified, transferred or forwarded.

Select **Menu** > **Media** > **RealPlayer**.

RealPlayer can play video clips and audio files that are stored in the device memory or on a memory card, transferred to your device from e-mail or compatible PC, or streamed to your device over the Web.

Formats supported by **RealPlayer** include MPEG-4, MP4 (not streaming), 3GP, RV, RA, AAC, AMR, and Midi. **RealPlayer** does not necessarily support all variations of a media file format.



Tip: Streaming audio and video files means playing them directly from the Web without downloading them first to your device.

Play video clips and stream links

To select audio and video files to play with **RealPlayer**, select **Options** > **Open**, and scroll to a media clip in your device or on a memory card.

To play streaming media, select a Web link that points to a media clip, and select **Play**; or connect to the Web, browse to a video clip or audio file, and select **Play**. **RealPlayer** recognizes two kinds of links: an `rtsp://` URL and an `http://` URL that points to a RAM file. Before the content begins streaming, your device must connect to a Web site and buffer the content. If a network connection

problem causes a playback error, **RealPlayer** attempts automatically to reconnect to the Internet access point.

To save a media clip, select **Options** > **Save**, scroll to a folder in device memory or on a memory card, and select **Save**. To save a link to a media file on the Web, select **Save link**.

To fast-forward or rewind the clip during playback, scroll up or down.

To increase or decrease the volume during playback, scroll right or left.

Settings

Select **Menu** > **Media** > **RealPlayer** > **Options** > **Settings**.

Video settings

Select **Video** > **Loop** > **On**, if you want to replay video clips automatically after they finish playing.

Connection settings

Select **Connection**, scroll to the following settings, and press the joystick to edit:

- **Proxy** — Select whether to use a proxy server and to key in the proxy server's IP address and port number.
- **Network** — Change the access point to connect to the Internet and to set the port range used when connecting.

Proxy settings

Proxy servers are intermediate servers between media servers and their users. Some service providers use them

for additional security or to speed up access to Web pages that contain media files.

Contact your service provider for the correct settings.

Select **Connection** > **Proxy**, scroll to the following settings, and press the joystick to edit:

- **Use proxy** — Select **Enable** to use a proxy server.
- **Proxy serv. address** — Enter the IP address of the proxy server. This setting is only available if you select to use a proxy server.
- **Proxy port number** — Enter the port number of the proxy server. This setting is only available if you select to use a proxy server.

Network settings

Contact your service provider for the correct settings.

Select **Connection** > **Network**, scroll to the following settings, and press the joystick to edit:

- **Default access point** — Scroll to the access point to connect to the Internet, and press the joystick.
- **Online time** — Set the time when **RealPlayer** disconnects from the network when you pause a media clip that plays using a network link. Select **User defined**, and press the joystick. Enter the time, and select **OK**.
- **Lowest UDP port** — Enter the lowest port number of the server port range. The minimum value is 1024.
- **Highest UDP port** — Enter the highest port number of the server port range. The maximum value is 65535.

Music player



Warning: Do not hold the device near your ear when the loudspeaker is in use, because the volume may be extremely loud.

Select **Menu** > **Media** > **Music player**.

With the music player, you can play music files and create and listen to track lists. The music player supports files with extensions such as MP3 and AAC.

Listen to music



Warning: Listen to music at a moderate level. Continuous exposure to high volume may damage your hearing.

To select a music track, select **Options** > **Music library**. **All tracks** lists all music on your device. To view sorted songs, select **Albums**, **Artists**, **Genres**, or **Composers**. To play a track, scroll to the track, and select **Options** > **Play**. When a track is playing, to change between play and pause, press **▶** and **⏸**. To stop a track, press **■**.

After you add or remove music files in the device, update your **Music library**. Select **Options** > **Update Music library**. The player searches the device memory for music files and updates them to the **Music library**.

To select the previous or next track, scroll the joystick up or down.

To play the music tracks repeatedly, select **Options** > **Loop**. Select **All** to repeat all the tracks in the current

folder, **One** to repeat the selected track, or **Off** to set off the repeating.

To play music in random order, select a folder and **Options** > **Random play**.

To view music track information, scroll to the desired track and select **Options** > **Track details**.

Adjust music volume

To control the music volume, press the volume keys. To mute the volume, press the lower volume key until the volume is muted.

Track lists

You can create a new track list and add tracks to it, or select a saved track list.

To create a new track list, select **Options** > **Music library** > **Track lists** > **Options** > **New track list**. Write the name of the new track list, and select **OK**.

To add a track to a track list, open the track list, and select **Options** > **Add tracks**.

Equalizer

Select **Menu** > **Media** > **Music player** > **Options** > **Equaliser**.

You can personalize the sound of your music files with **Equaliser**. You can use preset frequency settings based on styles of music, like classical or rock. You can also create

customized settings based on your own listening preferences.

You cannot use other functions of **Music player** while **Equaliser** is open.

With **Equaliser**, you can enhance or diminish frequencies during music playback and modify how your music sounds. There are preset frequency settings in your device, for example, **Classical** and **Rock**.

To use a preset frequency setting when playing music, scroll to the frequency setting you want to use, and select **Options** > **Activate**.

Create your own frequency setting

1. To create your own frequency setting, select **Options** > **New preset**.
2. Enter a name for the preset frequency setting, and select **OK**.
3. Scroll up or down to move between the frequency bands and set the frequency on each band. To move between bands, scroll left or right.
4. Select **Back** to save the new frequency setting or select **Options** > **Reset to defaults** to set the bands at a neutral frequency and start over.

Recorder

Select **Menu** > **Media** > **Recorder**.

With **Recorder**, you can record up to 60 seconds of a voice memo, save the voice recording as a sound clip, and play the sound clip. **Recorder** supports the AMR format.

Press the voice key to activate **Recorder**. If you have logged in to push to talk, the voice key works as a push to talk key and does not activate **Recorder**.

To record a voice memo, select **Options** > **Record sound clip**. Select **Pause** to pause the recording and **Record** to resume recording. When you finish recording, select **Stop**. The sound clip is automatically saved.

The maximum length of a voice recording is 60 seconds, but it also depends on the storage space available in device memory or on a memory card.

Play a voice recording

To listen to a voice recording that you just recorder, select the play icon. (▶). Select **Stop** to cancel playback. The progress bar displays the playing time, position, and length of a voice recording.

To pause playback of a voice recording, select **Pause**. Playback resumes when you select **Play**.

Voice recordings that you receive or record are temporary files. You must save the files that you want to keep.

Flash player

Select **Menu** > **Media** > **Flash Player**.

With **Flash Player**, you can view, play, and interact with flash files made for mobile devices.

To open a folder or play a flash file, scroll to the folder or file, and press the joystick.

To send a flash file to compatible devices, scroll to it, and press the call key. Copyright protection may prevent the sending of some flash files.

To switch between flash files saved on your device memory or memory card, scroll left or right.

The available options may vary.

Office applications

Select **Menu** > **Office**.

Some office applications are not available in all languages.

Opening a large file may not be possible or it may take a while.

File manager

With **File mgr.**, you can manage the contents and properties of files and folders. You can open, create, move, copy, rename, and search for files and folders. Copyright protection may prevent sending some files.

Documents

You can open, edit, and save documents created with Microsoft Word for Windows versions 97 or later. Note that not all features and formatting of the original files are supported.

Select **Menu** > **Office** > **Docum..**

To open an existing document, browse for the folder and document, and press the joystick. To read the document, select the middle view.



Tip: To open a recently used document, select **Options** > **Most recent files**, select the document, and press the joystick.

To create a new document, select **Options** > **New file**. Select **Blank** to create a new document without using a template or **Use template** to create a document based on an existing template.

To read a document, select the middle view and **Options**. You can browse for different types of objects in the document, zoom in or out, switch between full and normal screen views, or view objects, such as images. You can also search for text and edit application settings such as zooming, scrolling, and handling of invisible characters.



Tip: To switch between full and normal screen views in an open document, press *****. To zoom in, press **5**, and to zoom out, press **0**.

View objects in a document

To view all objects, such as tables, comments, workbooks, and video clips in their place in the document, select the middle view and **Options** > **Browse** > **Pages and objects**.

To open a table or comment, scroll to the object or its icon, and press the joystick twice.

To open an image or go to a hyperlink or reference, scroll to the object, and press the joystick three times.

Edit documents

To be able to edit a document, you must activate the edit mode: select the middle view and **Options > Edit document**. Select **Options > Format**, and the appropriate formatting option. For example, you can add bold, italic, and underline formatting, change the font size and color, and add bullets. You can also modify the paragraph settings such as text alignment and line spacing.



Tip: To cancel an action in the editing mode, select **Options > Undo**.

To insert a new object to the document, select **Options > Insert object**. Scroll to the desired object type, and select **Options > Insert**. If you want to insert a new document, workbook, or presentation, select **Insert new**. To insert an existing document, workbook, presentation, select **Insert existing**.

To format the style settings of a paragraph, select **Options > Format > Style**. Select the style you want to format and **Options > Edit**. Select **New style** to add a new style. In the style editing view, select **Options > Format**, and the style you want. You can modify the font, formatting, paragraph, bullet, and border styles.

View document structure

To view the document outline, select the left view. Select **Options > Expand** or **Collapse** to show only main chapters or all subchapters. If there are objects in the document, select **Options > Display objects** or **Display headings** to switch between object list and chapter heading views.



Tip: To open a selected chapter in the normal view, scroll to the chapter, and press the joystick.

Preview the page layout

To preview the page layout, select the view on the right and **Options**.

Define the following options:

- **Normal view** — Show the current open page in normal view.
- **Pan and zoom** — Zoom the page layout view.
- **View** — Select **Full screen** or **Normal screen** to switch between full screen and normal views.

To zoom the page layout, select the view on the right, scroll to the desired page, and select **Options > Pan and zoom**. A black selection frame appears above the page layout, showing the area to zoom. Select the area and **Options > Zoom**.

Select from the following options:

- **In** or **Out** — Select **In** to zoom in one step in the selected area, or **Out** to zoom out one step in the selected area.
- **Fit to screen** — Adjust the zoom level to fit the page to the screen width.
- **Ratio** — Edit the zoom level, enter the zoom ratio between 10 and 999, and select **OK**.

Find text

To find a piece of text from the document, select **Options** > **Find**, enter the text in the **Find:** field, and press the joystick.

To change search options such as case sensitivity and search direction, select **Options** > **Search options**.

Table editor

You can view tables created in applications, like documents and MS Word.

To view a table in a file, scroll to the file so that a dotted line appears around it, and press the joystick.

To change the selected cell, scroll up, down, left or right. If the selected cell does not fit into visible area, pressing the joystick pans the whole content first before the cell changes.

To edit the text in a cell, select the cell, and press the joystick. To end editing, press the joystick again.

Select **Options** and from the following options:

- **Zoom** — Zoom the table view in, out and to edit a zoom ratio.
- **Format** — Modify the font style and formatting, paragraphs, bullets, and borders.
- **Cell size** — Change the size of the cells, rows and columns.
- **Cells** — Select option to insert, delete, merge or separate cells.
- **Copy table** — Copy the text of the whole table to the clipboard.

Sheet

Select **Menu** > **Office** > **Sheet**.

To open an existing workbook, browse for the folder where the file is saved, and press the joystick.

To create a new workbook, select **Options** > **New file**. Select **Blank** to create a new file without using any template or **Use template** to create a file based on an existing template. Select the worksheet in the outline view, and press the joystick to open the file.

Work with worksheets

To insert data into cells, open the worksheet view. Use the joystick to move to the cell, and select **Options** > **Show cell field** > **Edit cell field**. An upper part editing field opens. Enter the data, and select **Done** to finish editing.

To select a range of cells, press and hold the edit key while you scroll right.

To modify the worksheet view, select **Options** > **View**.

Select from the following options:

- **Pan worksheet** — Define the size of the visible area of the whole worksheet.
- **Full screen** — Switch to the full screen view.
- **Hide headers** — Hide header field and release more space for the worksheet grid.
- **Hide gridlines** — Hide gridlines.

To change the font and number formatting, borders, and alignments, select **Options** > **Format** and the appropriate option.

Work with cells

To insert cells, select the area where you want to insert new cells and **Options > Cells > Insert**. You can insert cells above (**Shift cells down**) or to the left (**Shift cells right**) of the selected range. If you select only one cell, only one new cell is inserted. If you select a range of cells, a corresponding range of blank cells is inserted. You can also insert a new row or column.

To delete cells, rows, or columns, select the items you want to delete and **Options > Cells > Delete**. You can delete an entire row or column. If you select **Shift cells left**, the selected cells are deleted, and the cells right of the selected cells are shifted left. If you select **Shift cells up**, the cells below the deleted cells are shifted up.

To insert a function into a cell, select a cell. Select **Options > Insert > Function** and a function from the list. For example, **#MIN** finds the lowest value in the numeric contents of a selected range of cells, **#AVERAGE** calculates the average of the values, and **#SUM** adds the values together. Once you have selected a function, press the joystick. The function is inserted into the selected cell. On the worksheet, enter the cells you want to include in the function inside the brackets, and press the joystick.



Tip: Before inserting a function, verify that **Options > Show cell field > Edit grid** is active and that the selected cell is empty or starts with =.

Create and modify charts

When you change the information on a worksheet, the chart is updated simultaneously.

To open a chart, open the outline view, select the worksheet and chart, and press the joystick. If charts are not visible, select **Options > Expand**.

To create a new chart, select the worksheet cells that contain the information you want to include in the chart and **Options > Insert > Chart**. To change the general appearance of an existing chart, open a chart view. Select **Options > View > Chart**. You can change the name of the chart and define the cell area. You can change the type of the chart, and make the chart two or three-dimensional or change the color of the background and axis. Scroll right to add a title to the chart and axis.

To format a chart in more detail, open a chart view. Select **Options > View** and the object you want to edit. You can change the series, X-axis, and Y-axis settings (such as the tick marks of either axis).

Presentation

You can open, view, edit, and save presentations created with Microsoft PowerPoint 97 or later. You can also create new presentations. Note that not all features and formatting of the original files are supported.

Select **Menu > Office > Presentat.**

To open an existing presentation, browse for the folder and file, and press the joystick.

To create a new presentation, select **Options > New file**. Select **Blank** to create a new presentation without using a template or **Use template** to create a presentation based on an existing template.

View slide shows

To start a slide show, select **Options > Presentation**.

Select from the following options:

- **Manual** — Move from one slide to another manually.
- **Slide show** — Move from one slide to another manually, or use the automatic slide switching. You must specify the duration for a slide.
- **Manual looped** — The slide show continues from the beginning when the last slide of a presentation has been shown.
- **Looped slide show** — The slide show continues automatically from the beginning when the last slide of a presentation has been shown.

To move between slides in a slide show, scroll up to display a previous slide and down to display the next slide.

To end the slide show, press the right selection key.

Work with different views

The presentation application consists of different views that help you when reading and creating presentations.

To switch between the different views, scroll right and left with the joystick.

Layout view

To open the layout view, select the view in the middle. To enable or disable the visibility of charts, comments, tables, images, and shapes, select **Options > Settings**, scroll to the settings item, and press the joystick.

Outline view

The outline view is used to navigate through long presentation documents. The view enables fast vertical scrolling, rearranging of slides, and editing of objects.

To open the outline view, scroll to the view on the left. In the outline view, each slide has its own main level entry. Under the main level there is a sublevel for each text field and object.

To view the slide content, select **Options > Expand**. To hide the content, select **Options > Collapse**. To collapse or expand all entries, select **Options > View > Collapse all** or **Expand all**.

To change the order of slides, scroll to the slide you want to move, and select **Options > Slide > Move**. Scroll up and down to select a new location, and select **OK**.

Notes view

In the notes view, you can read notes that are attached to slides in the presentation. You can also add your own notes.

To open the notes view, scroll to the view on the right. Each slide has its own main level entry. Under the main level there is a sublevel for notes. If notes are not visible, select **Options > View > Expand all**. To edit a note, scroll to the note, and press the joystick.

Edit presentations

To edit a presentation, open the layout view, and select **Options > Editslide**. Scroll right or down with the joystick

to move forward and left or up to move backward. Select **Options**.

Define the following options:

- **Add title, Add subtitle, Add text, Insert table, Insert image** — Add a new text or object inside the selected area.
- **Edit text, Edit table, Edit document, Edit workbook** — Edit the selected object.
- **Edit object** — Select **Move** to move the object, scroll to the item, and press the joystick. Select **Resize** to change the size of the object. Scroll right and left to change the horizontal size of the object and up and down to change the vertical size. To accept the changes, press the joystick. Select **Rotate** to rotate the object. Scroll right to rotate the object clockwise and left to rotate counterclockwise. To accept the changes, press the joystick. Select **Properties** to edit text, line, border, or background properties of the object.
- **Object** — Delete, copy, paste, or add a link to the selected object.
- **Object position** — Change the layered position of the selected object in the presentation: up, down, front, or back.
- **Insert** — Add a new text box, image, shape, table, or comment to the presentation.
- **Undo, Redo** — Withdraw the latest modifications.

Find text in a presentation

To find a piece of text from in the presentation, select any of the views. Select **Options** > **Find**, enter the text in the **Find**: field, and press the joystick.

To change the search option for case and whole words, select **Options** > **Search options**.

Screen export

You can show the screen of the device to an audience with a compatible data projector, or other compatible projection system. The screen content is transferred to the data projector using, for example, a Bluetooth connection.

Select **Menu** > **Office** > **Screen export**.

To be able to show screen content with a compatible data projector, you must install the drivers of the data projector. For more information, check with the data projector manufacturer or its representative.

Not all applications support this feature. You can start the external viewer in two ways: from the **Office** folder or inside an application that supports it.

Show screen content

To show screen content with a data projector, open the screen export application, and select **Options** > **Select device**. In the list of available devices, scroll to the device you want to use, and select **OK**. Select **Options** > **Enable** to show screen content.

To hide the screen content, select **Options** > **Hide**. The screen exporter application is moved to the background.

To stop showing screen content, select **Options** > **Disable**.

Print

Print a message or file from the device. Preview a print job, define page layout options, select a printer, or print to a file.

Before you print, make sure that your device is properly connected to the printer.

To print a message or file, open the message or file, and select **Options** > **Printing options**.

Define the following options:

- **Printer** — Select an available printer from the list.
- **Print** — Select **All pages**, **Even pages**, or **Odd pages** as the print range.
- **Print range** — Select **All pages in range**, **Current page**, or **Defined pages** as the page range.
- **Number of copies** — Select the number of copies to print.
- **Print to file** — Select to print to a file and determine the location for the file.

You may not be able to print all messages, such as multimedia messages or other special message types.

To preview a file or message before you print, select **Options** > **Printing options** > **Preview**.

To change the page layout before printing, select **Options** > **Printing options** > **Page setup** and from the following tabs:

- **Paper size** — Change the paper size or orientation and customize the height and width.
- **Margins** — Change the size of the left, right, top, or bottom margins.
- **Header** — The maximum length of the header is 128 characters. You can set the distance from the header

to the text and choose to include the header on the first page of the document.

- **Footer** — The maximum length of the footer is 128 characters. You can set the distance from the footer to the text.

To add or delete a printer, select **Menu** > **Office** > **Printers** > **Options** > **Add** or **Delete**.

Settings

Select **Menu** > **Tools** > **Settings**.

You can define and modify various settings of your device. Modifying these settings affects the operation of your device across several applications.

Some settings may be preset for the device or sent to you in a configuration message by your network operator or service provider. You may not be able to change such settings.

Scroll to the setting that you want to edit, and press the joystick to do the following:

- Switch between two values, such as on or off.
- Select a value from a list.
- Open a text editor to enter a value.
- Open a slider to decrease or increase the value by scrolling left or right.

Phone settings

Select **Phone** to change the language settings, standby mode settings, and display settings of your device.

General settings

Select **General** and from the following:

- **Phone language** — Select a language from the list. Changing the device language affects every

application in your device. When you change the language, the device restarts.

- **Writing language** — Select a language from the list. Changing the writing language also affects the characters that are available when writing text and the predictive text dictionary that is used.
- **Predictive text** — Select **On** to use predictive text input. The predictive text dictionary is not available for all languages.
- **Welcome note / logo** — Select **Default** to use the default image, **Text** to enter a welcome note of your own, or **Image** to select an image from the Gallery. The welcome note or image is displayed briefly each time you switch on the device.
- **Orig. phone settings** — Restore the original device settings. To do this, you need your device lock code. After resetting, the device may take a longer time to power on. Documents, contact information, calendar entries, and files are unaffected.

Standby mode settings

Select **Standby mode** and from the following:

- **Active standby** — Select **On** to have shortcuts to different applications available in the active standby mode.
- **Left selection key, Right selection key** — Change the shortcuts that open from the left and right selection keys in the standby screen. Press joystick, select a function from the list, and **OK**.

- **Navigation key right, Navigation key left, Navigat. key down, Navigation key up, Selection key** — Change the shortcuts that open when you scroll to different directions. These settings are not available if you select **Active standby** > **On**.

Display settings

Select **Display** and from the following:

- **Light sensor** — Adjust the amount of light required to illuminate the device display.
- **Power saver time-out** — Select the amount of time before the screen saver is activated. Activating the screen saver lengthens the device operating time.
- **Light time-out** — Set how quickly after last keypress the display dims.

Call settings

Select **Call** and from the following:

- **Send my caller ID** — Select **Yes** to display your phone number to the person you are calling or **Set by network** to let the network to determine whether your caller ID is sent.
- **Send my net call ID** — Set this feature on if you want to display your net caller ID to the person you are calling.
- **Call waiting** — Select **Activate** to be notified of a new incoming call while you have a call in progress or **Check status** to check if the function is active on the network.
- **Internet call waiting** — Activate this feature to be notified of a new incoming call while you have a net call in progress.

- **Internet call alert** — Set this on if you want the device to respond to the caller that it is busy. If you set this off, the device emits a busy tone to the caller and you receive a notification about the missed call.
- **Default call type** — Select **Cellular** to make normal calls to the phone number or **Internet** to use VoIP to call the number or address.
- **Reject call with SMS** — Select **Yes** to send a text message automatically to the person who is calling you informing why you cannot answer their incoming call.
- **Message text** — Enter the text that is sent when you cannot answer an incoming call and want to automatically send a text message as a reply.
- **Image in video call** — Select **Use selected** to select a still image to be displayed instead of a video during a video call or **None** to not send any image during a video call.
- **Automatic redial** — Select **On** to redial a number if it was busy at the first call attempt. Your device makes a maximum of 10 attempts to connect the call.
- **Summary after call** — Select **On** to briefly display the approximate duration of the last call.
- **Speed dialling** — Select **On** to activate speed dialing on your device. To dial a phone number assigned to the speed dialing keys (2-9), press and hold the key. See "Speed dial," p. 26.
- **Anykey answer** — Select **On** to answer an incoming call by briefly pressing any key, except the end key.
- **Line in use** — Select **Line 1** or **Line 2** to change the phone line for outgoing calls and text messages (network service). This setting is displayed only if the SIM card supports the alternate line service and a subscription to two phone lines.

- **Line change** — Select **Disable** to prevent line selection (network service). To change this setting, you need the PIN2 code.
- **Internet call alert** — Select **Off** to notify incoming net calls that your device is busy or **On** to accept incoming net calls.

Connection settings

Select **Menu** > **Tools** > **Settings** > **Connection** and from the following:

- **Access points** — Set up new or edit existing access points. Some or all access points may be preset for your device by your service provider, and you may not be able to create, edit, or remove them.
- **Access point groups** — Set up new or edit existing access point groups that are used in automatic connection establishment and e-mail roaming.
- **Packet data** — Determine when packet data connections are used, and enter the access point if you use your device as a modem for a computer.
- **Internet tel. settings** — Define settings for net calls.
- **SIP settings** — View or create session initiation protocol (SIP) profiles.
- **Data call** — Set the time-out period after which data call connections automatically end.
- **VPN** — Install and manage VPN policies, manage VPN policy servers, see the VPN log, and create and manage VPN access points.
- **Wireless LAN** — Determine if the device displays an indicator when a wireless LAN is available, and how often the device searches for networks.
- **Configs.** — View and delete trusted servers from which your device may receive configuration settings.

To obtain information about wireless LAN or subscribing to a packet data service and the appropriate connection and configuration settings, contact your network operator or service provider.

The settings available for editing may vary.

Access points

Select **Menu** > **Tools** > **Settings** > **Connection** > **Access points**.

An access point is where your device connects to the network by way of a data connection. To use e-mail and multimedia services or to browse web pages, you must first define access points for these services.

An access point group is used for grouping and prioritizing access points. An application can use a group as a connection method instead of a single access point. In that case, the best available access point inside a group is used for making the connection, and in case of e-mail, also for roaming.

Some or all access points may be preset for your device by your service provider, and you may not be able to create, edit, or remove them.

See "Internet access points," p. 54.

Access point groups

Select **Menu** > **Tools** > **Settings** > **Connection** > **Access point groups**.

An access point group is used for grouping and prioritizing access points. An application can use a group as a connection method instead of a single access point.

In that case the best available access point inside a group is used for making connection and in case of e-mail, also for roaming. See "Access point groups," p. 64.

Packet data

Select **Menu** > **Tools** > **Settings** > **Connection** > **Packet data**.

Your device supports packet data connections, such as GPRS in the GSM network. When you are using your device in GSM and UMTS networks, it is possible to have multiple data connections active at the same time; access points can share a data connection, and data connections remain active (for example, during voice calls). See "Connection manager," p. 62.

Packet data settings

The packet data settings affect all access points using a packet data connection.

Select from the following:

- **Packet data conn.** — Select **When available** to register the device to the packet data network when you switch the device on in a supported network. Select **When needed** to establish a packet data connection only when an application or action requires it.
- **Access point** — Enter the access point name provided by your service provider to use the device as a packet data modem to your computer.

These settings affect all access points for packet data connections.

Net call settings

Select **Menu** > **Tools** > **Settings** > **Connection** > **Internet tel. settings**. Select **Options** > **New profile** or **Options** > **Edit**.

Scroll to **Name**, press the joystick, enter a name for the profile, and select **OK**.

Scroll to **SIP profiles**, press the joystick, select a profile and **OK**. SIP protocols are used for creating, modifying, and terminating communications sessions such as net calls with one or more participants. SIP profiles include settings for these sessions.

To save your settings, press **Back**.

Data call settings

Select **Menu** > **Tools** > **Settings** > **Connection** > **Data call**.

To set the time-out period after which data calls automatically end if no data has been transferred, select **Online time**, and press the joystick. Select **User defined** to enter the time yourself or **Unlimited** to keep the connection active until you select **Options** > **Disconnect**.

VPN

VPN access points

To manage VPN access points, select **VPN** > **VPN access points** > **Options**, and from the following:

- **Edit** — Edit the selected access point. If the access point is in use or its settings are protected, you cannot edit it.
- **New access point** — Create a new VPN access point.
- **Delete** — Delete the selected access point.

VPN access point settings

Contact your service provider for the correct access point settings.

To edit VPN access point settings, select the access point and **Options**.

Select from the following:

- **Connection name** — Enter a name for the VPN connection. The maximum length of the name is 30 characters.
- **VPN policy** — Select a VPN policy to be used with this access point.
- **Internet access pt.** — Select the Internet access point to be used with this VPN access point.
- **Proxy serv. address** — Enter the proxy server address of this VPN access point.
- **Proxy port number** — Enter the number of the proxy port.

Wireless LAN

Select **Menu** > **Tools** > **Settings** > **Connection** > **Wireless LAN**.

To have an indicator displayed when there is a wireless LAN available in your current location, select **Show availability** > **Yes**.

To select the time interval for your device to scan for available wireless LANs and update the indicator, select **Scan for networks**. This setting is not visible unless you select **Show availability** > **Yes**.

Advanced WLAN settings

Select **Menu** > **Tools** > **Settings** > **Connection** > **Wireless LAN** > **Options** > **Advanced settings**. The wireless LAN advanced settings are normally defined automatically, and changing them is not recommended.

To edit the settings manually, select **Automatic config.** > **Disabled**, and define the following:

- **Long retry limit** — Enter the maximum number of transmission attempts if the device does not receive a receiving acknowledgement signal from the network.
- **Short retry limit** — Enter the maximum number of transmission attempts if the device does not receive a clear-to-send signal from the network.
- **RTS threshold** — Select the data packet size at which the wireless LAN access point device issues a request to send before sending the packet.
- **TX power level** — Select the power level of your device when sending data.
- **Radio measurements** — Enable or disable the radio measurements.

To restore all settings to their original values, select **Options** > **Restore defaults**.

Security settings for wireless LAN access points

WEP security settings

Select **Menu** > **Tools** > **Settings** > **Connection** > **Access points**. Select **Options** > **New access point**, or select an access point and **Options** > **Edit**.

In the access point settings, select **WLAN security mode** > **WEP**.

Wired equivalent privacy (WEP) encryption method encrypts data before it is transmitted. Access to the network is denied to users who do not have the required WEP keys. When WEP security mode is in use, if your device receives a data packet not encrypted with the WEP keys, the data is discarded.

In an **Ad-hoc** network, all devices must use the same WEP key.

Select from the following:

- **WEP key in use** — Select the desired WEP key.
- **Authentication type** — Select **Open** or **Shared**.
- **WEP key settings** — Edit the settings for the WEP key.

WEP key settings

Select **Menu** > **Tools** > **Settings** > **Connection** > **Access points**. Select **Options** > **New access point**, or select an access point and **Options** > **Edit**.

In the access point settings, select **WLAN security mode** > **WEP**.

In an **Ad-hoc** network, all devices must use the same WEP key.

Select **WLAN security sett.** > **WEP key settings** and from the following:

- **WEP encryption** — Select the desired WEP encryption key length.
- **WEP key format** — Select whether you want to enter the WEP key data in **ASCII** or **Hexadecimal** format.
- **WEP key** — Enter the WEP key data.

802.1x security settings

Select **Menu** > **Tools** > **Settings** > **Connection** > **Access points**. Select **Options** > **New access point**, or select an access point and **Options** > **Edit**.

In the access point settings, select **WLAN security mode** > **802.1x**.

802.1x authenticates and authorizes devices to access a wireless network, and prevents access if the authorization process fails.

Select **WLAN security sett.** and from the following:

- **WPA mode** — Select **EAP** (Extensible Authentication Protocol) or **Pre-shared key** (a secret key used for device identification).
- **EAP plug-in settings** — If you selected **WPA mode** > **EAP**, select which EAP plug-ins defined in your device to use with the access point.
- **Pre-shared key** — If you selected **WPA mode** > **Pre-shared key**, enter the shared private key that identifies your device to the wireless LAN to which you connect.

The settings available for editing may vary.

WPA security settings

Select **Menu** > **Tools** > **Settings** > **Connection** > **Access points**. Select **Options** > **New access point**, or select an access point and **Options** > **Edit**.

In the access point settings, select **WLAN security mode** > **WPA/WPA2**.

Select **WLAN security sett.**, and from the following:

- **WPA mode** — Select **EAP** (Extensible Authentication Protocol) or **Pre-shared key** (a secret key used for device identification).
- **EAP plug-in settings** — If you select **WPA mode** > **EAP**, select which EAP plug-ins defined in your device to use with the access point.
- **Pre-shared key** — If you select **WPA mode** > **Pre-shared key**, enter the shared private key that identifies your device to the wireless LAN to which you connect.
- **TKIP encryption** — To enable TKIP encryption, based on transient keys changed often enough to prevent misuse, select **Allowed**. All devices in the wireless LAN must either allow or prevent the use of TKIP encryption.

The settings available for editing may vary.

EAP

To view the EAP (extensible authentication protocol) plug-ins currently installed in your device (network service), select **Menu** > **Tools** > **Settings** > **Connection** > **Access points**. Select **Options** > **New access point** and define an access point that uses wireless LAN as a data bearer and **802.1x** or **WPA/WPA2** as their security mode. Select **WLAN security sett.** > **WPA mode** > **EAP**, scroll to **EAP plug-in settings**, and press the joystick. EAP settings

Select **Menu** > **Tools** > **Settings** > **Connection** > **Access points**. Select **Options** > **New access point**, or select an access point and **Options** > **Edit**.

Select **WLAN security mode** > **802.1x** or **WPA/WPA2**.

Select **WLAN security sett.** > **WPA mode** > **EAP**, scroll to **EAP plug-in settings**, and press the joystick.

The extensible authentication protocol (EAP) plug-ins are used in wireless networks to authenticate wireless devices and authentication servers, and the different EAP plug-ins make possible the use of various EAP methods (network service).

To use an EAP plug-in when you connect to a WLAN using the access point, select the desired plug-in and **Options** > **Enable**. The EAP plug-ins enabled for use with this access point have a check mark next to them. To not use a plug-in, select **Options** > **Disable**.

To edit the EAP plug-in settings, select **Options** > **Configure**.

To change the priority of the EAP plug-in settings, select **Options** > **Raise priority** to attempt to use the plug-in before other plug-ins when connecting to the network with the access point, or **Options** > **Lower priority** to use this plug-in for network authentication after attempting to use other plug-ins.

The available options may vary.

See the device help for more information on EAP plug-ins.

Configurations

To view and delete configurations for trusted servers, select **Menu** > **Tools** > **Settings** > **Connection** > **Configs.**

You can receive messages from your network operator, service provider, or company information management that contain configuration settings for trusted servers. These settings are automatically saved in **Configs.** You may receive configuration settings for access points,

multimedia or e-mail services, and IM or synchronization settings from trusted servers.

To delete configurations for a trusted server, scroll to the server, and press the clear key. The configuration settings for other applications provided by this server are also deleted.

Date and time settings

See "Clock settings," p. 92.

Security settings

See "Define security settings," p. 33.

Enhancement settings

Select **Menu** > **Tools** > **Settings** > **Enhancement**.



Warning: When you use the headset, your ability to hear outside sounds may be affected. Do not use the headset where it can endanger your safety.

With most enhancements, you can select from the following settings:

- **Default profile** — Select the profile that is activated when you attach an enhancement to your device.
- **Automatic answer** — Let the device answer phone calls automatically when an enhancement is attached. Select **On** to have the device answer an incoming call automatically after 5 seconds. If the ringing type is set to **Beep once** or **Silent** in the Profiles menu, automatic answer is disabled.

- **Lights** — Select **On** to illuminate the device while it is attached to an enhancement.

Organiser

Select **Menu** > **Organiser**.

Organiser includes tools that help you organize and manage the details of different events in your personal and business life.

Calendar

Select **Menu** > **Organiser** > **Calendar**.

In **Calendar**, you can create and view scheduled events and appointments. You can also set alarms for calendar entries.

You can synchronize your calendar data with a compatible computer using Nokia PC Suite. For information on synchronization, see the PC Suite guide.

Create calendar entries

You can create four types of calendar entries:

- **Meeting** entries have a specific date and time.
- **Memo** entries are related to the whole day but not to a specific time of the day. Memo entries do not appear in the weekly time schedule view.
- **Anniversary** entries remind you of birthdays and special dates. They refer to a certain day but not a specific time of the day. Anniversary entries are repeated every year.

- **To-do note** entries remind you of a task that has a due date but not a specific time of the day.

To create a calendar entry, scroll to a date, and select **Options** > **New entry**. Select an entry type. Available settings for meeting, memo, anniversary, and to-do entries vary.

To open and edit an existing entry, scroll to the entry, and select **Options** > **Open**. Edit the details in the various fields.



Tip: When you edit or delete a repeated entry, choose how you want the change to take effect. If you select **All calendar entries deleted**, all repeated entries are deleted. If you select **Delete entry**, only the current entry is deleted.

To-do

You can create and maintain a task or list of tasks that must be done by a certain day. Each task can be assigned a due date, but not a specific time of the day.

To open the list of to-do notes, select **Options** > **To-do list**.

To add a to-do note, select **Options** > **New entry** > **To-do**. Start to write the task in the **Subject** field. You can set a due date for the task, and specify a priority. The priority icons are (!) **High** and (-) **Low**. There is no icon for **Normal**.

To mark a task as completed, scroll to the task in the to-do list, and select **Options** > **Mark as done**.

To restore a task, scroll to it in the todo list, and select **Options** > **Mark as not done**.

Calendar views

To switch between the different calendar views, select **Options** in any calendar view. Select a type of view from the list.

To set the default calendar view, select **Options** > **Settings** > **Default view** > **Month view**, **Week view**, **Day view**, or **To-do view**.

To view a specific date in the calendar view, select **Options** > **Go to date**. Enter the date, and select **OK**.

Add a received calendar entry to your calendar

You can receive a calendar entry as an attachment to a multimedia or e-mail message.

To add a received calendar entry to your calendar, open the calendar entry attachment in the message, and select **Options** > **Save to Calendar**. The entry is added to your default calendar.

Notes

Select **Menu** > **Organiser** > **Notes**.

You can create and send notes to other compatible devices, and save plain text files (.txt format) that you receive to **Notes**.

To write a new note, select **Options** > **New note**, write the text and press **Done**.

Calculator



Note: This calculator has limited accuracy and is designed for simple calculations.

Select **Menu** > **Organiser** > **Calculator**.

To make a calculation, enter the first number of the calculation. Scroll to and select a function such as add or subtract from the function map. Enter the second number of the calculation, and select =. To add a decimal point, press #.

The calculator performs operations in the order they are entered. The result of the calculation remains in the editor field and can be used as the first number of a new calculation.

To save the results of a calculation, select **Options** > **Memory** > **Save**. The saved result replaces the previously stored number in memory.

To retrieve the results of a calculation from memory and use them in a calculation, select **Options** > **Memory** > **Recall**.

To view the last saved result, select **Options** > **Last result**.

Exiting the calculator application or turning off the device does not clear the memory. You can recall the last saved result the next time you open the calculator application.

Converter

Select **Menu** > **Organiser** > **Converter**.

The converter has limited accuracy, and rounding errors may occur.

Convert measurements

1. Scroll to the **Type** field, and select **Options** > **Conversion type** to open a list of measures. Scroll to the measure you want to use, and select **OK**.
2. Scroll to the first **Unit** field, and select **Options** > **Select unit**. Select the unit from which you want to convert, and select **OK**. Scroll to the next **Unit** field, and select the unit to which you want to convert.
3. Scroll to the first **Amount** field, and enter the value you want to convert. The other **Amount** field changes automatically to show the converted value.
Press **#** to add a decimal and ***** for + and - (for temperature), and **E** (exponent) symbols.

Set base currency and exchange rate



Note: When you change base currency, you must enter new exchange rates because all previously set exchange rates are cleared.

Before you can make currency conversions, you must choose a base currency and add exchange rates. The rate of the base currency is always 1. The base currency determines the conversion rates of the other currencies.

1. To set the rate of exchange for the unit of currency, scroll to the **Type** field, and select **Options** > **Currency rates**.
2. A list of currencies opens, and you can see the current base currency at the top. Scroll to the currency type and enter the exchange rate you would like to set per single unit of currency.
3. To change the base currency, scroll to the currency, and select **Options** > **Set as base curr.**
4. Select **Done** > **Yes** to save the changes.

After you have inserted all the necessary exchange rates, you can make currency conversions.

Voice mailbox

Select **Menu** > **Organiser** > **Voic. mail**.

When you open the voice mailbox application for the first time, you are asked to enter the number of your voice mailbox. To change the number, select **Options** > **Change number**. To call the number, select **Options** > **Call voice mailbox**.

Clock

Select **Menu** > **Clock**.

Clock settings

If the alarm time is reached while the device is switched off, the device switches itself on and starts sounding the alarm tone. If you select **Stop**, the device asks whether you want to activate the device for calls. Select **No** to switch

off the device or **Yes** to make and receive calls. Do not select **Yes** when wireless phone use may cause interference or danger.

To change the clock type, select **Options** > **Settings** > **Clock type** > **Analogue** or **Digital**.

To set an alarm, select **Options** > **Set alarm**. Enter the alarm time, and select **OK**.

To view and change alarms, select **Reset alarm**.

To remove an alarm, select **Remove alarm**.

Date and time settings

To change the date and time, their display formats, alarm tone, and to define whether you want to use automatic time update and daylight savings time, select **Options** > **Settings** and from the following:

- **Time** — Enter the time, and select **OK**.
- **Time zone** — Enter the time zone, and select **OK**.
- **Date** — Enter the date, and select **OK**.
- **Date format** — Change how the date is displayed. Scroll to the desired format, and select **OK**.
- **Date separator** — Change the symbol that separates days, months, and years. Scroll to the symbol you want, and select **OK**.
- **Time format** — Select **24-hour** or **12-hour**.
- **Time separator** — Select the symbol that separates hours and minutes.
- **Clock type** — Select **Analogue** or **Digital**.
- **Clock alarm tone** — Select the tone that you want to use for the alarm clock.
- **Network operator time** — Update time, date, and time zone information automatically (network service). Select **Auto-update** to activate. This service may not be available in all networks.

- **Daylight-saving** — Set the clock to automatically adjust for daylight savings time. Select **Auto-update**. This setting is only available if **Network operator time** is set to **Off**.

Add and delete cities

To add a city, scroll right, and select **Options** > **Add city**. Scroll to a city, and select **Options** > **Select**.



Tip: To search for a city in the **Cities** list, select **Options** > **Add city** > **Options** > **Find**. Enter the city name in the search field.

To delete a city, scroll right, scroll to the city, and select **Options** > **Remove**.

Changing the home city may change the general system time of your device.

Tools

Select **Menu** > **Tools**.

The **Tools** folder contains applications used to configure your device and to configure other applications.

Memory card—See "Memory card," p. 19.

Transfer—See "Transfer content between devices," p. 20.

Profiles—See "Profiles," p. 100.

Settings—See "Settings," p. 82.

Positioning

With the positioning service you can receive information from service providers about local issues such as weather or traffic conditions, based on the location of your device (network service).

Select **Menu** > **Tools** > **Positioning**.

To select a positioning method, scroll to the positioning method, and select **Options** > **Enable**. To stop using it, select **Options** > **Disable**. The **Bluetooth** positioning method enables you to use Bluetooth GPS enhancements for positioning. The **Network based** positioning method is provided by your network operator or service provider. Both positioning methods can be used simultaneously.

Navigator

This feature is not designed to support positioning requests for related calls. Contact your service provider for

more information about how your phone complies with government regulations on location based emergency calling services.

GPS should not be used for precise location measurement, and you should never rely solely on location data from the GPS receiver.

Select **Menu** > **Tools** > **Navigator**.

Navigator is a GPS application that enables you to view your current location, find your way to a desired location, and track distance. The application requires a Bluetooth GPS accessory to operate. You must also have Bluetooth GPS positioning method enabled in **Menu** > **Tools** > **Positioning**.

The application must receive positioning info from at least three satellites to use it as a traveling aid. Changes to this application may affect your privacy, so you must control how it is used.

Select from the following:

- **Navigator** — View navigating information to your trip destination.
- **Position** — View positioning information about your current location.
- **Trip dist.** — View your traveling information such as the distance and duration you have traveled and your average and maximum speeds.

Landmarks

Select [Menu](#) > [Tools](#) > [Landmarks](#).

Landmarks are coordinates to geographic locations that you can save to your device for later use in different location-based services. You can create landmarks using a Bluetooth GPS enhancement or network (network service). See "Navigator," p. 94.

To create a landmark, select [Options](#) > [New landmark](#). Select [Current position](#) to make a network request for the latitude and longitude coordinates of your current location or [Enter manually](#) to fill in the necessary location information such as a name, category, address, latitude, longitude and altitude.

To delete a landmark, scroll to it, and press the clear key. For more information, see the extended User's Guide on the Web.

Voice commands

Before using voice tags, note that:

- Voice tags are not language-dependent. They are dependent on the speaker's voice.
- You must say the name exactly as you said it when you recorded it.
- Voice tags are sensitive to background noise. Record voice tags and use them in a quiet environment.
- Very short names are not accepted. Use long names, and avoid similar names for different numbers.



Note: Using voice tags may be difficult in a noisy environment or during an emergency, so you should not rely solely upon voice dialing in all circumstances.

Select [Menu](#) > [Tools](#) > [Voice commands](#).

Use voice commands to make phone calls and to launch applications, profiles, or other functions on the device.

The device creates a voice tag for the entries in the contacts list and for the functions designated in the [Voice commands](#) application. When a voice command is spoken, the device compares the spoken words to the voice tag in the device.

Use a voice command to make a call

The voice tag for a contact is the name or nickname that is saved on the contact card in [Contacts](#). To listen to the voice tag, open a contact card, and select [Options](#) > [Playback](#).

1. To make a call using a voice command, press and hold the voice key.
2. When you hear the tone or see the visual display, clearly speak the name saved on the contact card.
3. The device plays a synthesized voice tag for the recognized contact in the selected device language, and displays the name and number. After a timeout of 1.5 seconds, the device dials the number. If the recognized contact was not correct, select [Next](#) to view a list of other matches or [Quit](#) to cancel dialing.

Use a voice command to launch an application

The device creates voice tags for the applications listed in the **Voice commands** application.

To launch an application using a voice command, press and hold the voice key, and clearly speak the voice command. If the recognized application was not correct, select **Next** to view a list of other matches or **Quit** to cancel.

To add more applications to the list, select **Options** > **New application**.

To change the voice command of an application, scroll to the application, and select **Options** > **Change command**. Type the new voice command, and select **OK**.

Use voice commands for profiles

The device creates a voice tag for each profile. To set on a profile using a voice command, press and hold the voice key, and say the name of the profile.

To change the voice command, scroll to the desired profile, and select **Profiles** > **Options** > **Change command**.

Voice command settings

To switch off the synthesizer that plays recognized voice commands in the selected device language, select **Settings** > **Synthesiser** > **Off**.

To reset voice recognition learning when the main user of the device has changed, select **Reset voice adapts..**

Voice aid

Select **Menu** > **Tools** > **Voice aid**.

The voice aid application allows you to operate the basic functions of your device without watching the display.

Select from the following:

- **Contacts** — View the entries in your contacts list.
- **Recent calls** — View your missed and received calls, dialed numbers, and frequent calls.
- **Voice mailbox** — Retrieve your voice messages.
- **Dialler** — Dial a telephone number.
- **Clock** — Hear the current time and date.

To hear more options, select **Options**.

Sett. wizard

Sett. wizard configures your device for operator (MMS, GPRS, and Internet), e-mail, push-to-talk (network service), and video sharing (network service) settings based on your network operator information.

To use these services, you may have to contact your network operator or service provider to activate a data connection or other services.

To edit settings, select **Menu** > **Tools** > **Sett. wizard** and the item you want to configure.

If you are not able to use **Sett. wizard**, visit the Nokia phone settings Web site at www.nokia.com.

Application manager

Select **Menu** > **Tools** > **Application manager**.

When you open the application manager, you see all the software packages that have been installed, with their name, version number, type, and size. You can view the details of installed applications, remove them from your device, and specify installation settings.

Certificate manager



Important: Note that even if the use of certificates makes the risks involved in remote connections and software installation considerably smaller, they must be used correctly in order to benefit from increased security. The existence of a certificate does not offer any protection by itself; the certificate manager must contain correct, authentic, or trusted certificates for increased security to be available. Certificates have a restricted lifetime. If Expired certificate or Certificate not valid yet is shown even if the certificate should be valid, check that the current date and time in your device are correct.

Before changing any certificate settings, you must make sure that you really trust the owner of the certificate and that the certificate really belongs to the listed owner.

Digital certificates are used to verify the origins of software but do not guarantee safety. There are three different types of certificates: authority certificates, personal certificates, and server certificates. During a secure connection, a server may send a server certificate to your device. Upon receipt, it is checked through an authority certificate stored on your device. You receive notification if the identity of the server is not authentic or if you do not have the correct certificate in your device.

Download a certificate from a web site, or receive a certificate as an e-mail attachment, or as a message sent through a Bluetooth or infrared connection. Certificates should be used when you connect to an online bank or a remote server to transfer confidential information. They should also be used if you want to reduce the risk of viruses or other malicious software, and to check the authenticity of software when you download and install software to your device.



Tip: When you add a new certificate, check its authenticity.

Nokia Catalogs

Select **Menu** > **Tools** > **Catalogs**. Select **OK** if you accept the disclaimer.

Nokia Catalogs (network service) is a mobile content shop available on your device. With Nokia Catalogs you can discover, preview, buy, download, and upgrade content, such as games, ringing tones, wallpapers, services, and applications, for your device. The available content depends on your network operator and service provider.

Nokia Catalogs uses your network services to access the most updated catalog content. For information on additional items available through Nokia Catalogs, contact your network operator or service provider.

Nokia Catalogs receives ongoing updates, bringing you the latest content your network operator or service provider offers for your device. To update the catalogs manually, select **Options** > **Refresh list**.

Device management

Manage data and software on your device.

Remote configuration network service

Select **Menu** > **Connectivity** > **Device mgr.**.

You can connect to a server and receive configuration settings for your device. You may receive server profiles and different configuration settings from your network operator, service providers, and company information management department. Configuration settings may include connection and other settings used by different applications in your device. Available options may vary.

The remote configuration connection is usually started by the server when the device settings need to be updated.

Remote configuration settings

In the **Device mgr.** main view, select **Options** and select from the following:

- **Start configuration** — Connect to the server and receive configuration settings for your device.
- **New server profile** — Create a new server profile.
- **Edit profile** — Change the profile settings.
- **Delete** — Remove the selected profile.
- **Enable config.** — Select to receive configuration settings from those servers for which you have a server profile and have allowed configuration.

- **Disable config.** — Select to stop receiving configuration settings from all servers for which you have a server profile.
- **View log** — View the configuration log of the selected profile.

Data synchronization

Menu > **Connectivity** > **Sync.**

Use **Sync** to synchronize your contacts, calendar, or notes with corresponding applications on a compatible computer or remote Internet server. Your synchronization settings are saved in a synchronization profile. The application uses SyncML technology for remote synchronization. For information on SyncML compatibility, contact the supplier of the applications with which you want to synchronize your device.

The available applications you can synchronize may vary. Contact your service provider for more information.



Tip: You may receive the synchronization settings as a message from your service provider.

Create a synchronization profile

To create a profile, select **Options** > **New sync profile** and select from the following options:

- **Sync profile name** — Enter a name for the profile.

- **Applications** — Select the applications to synchronize with the profile.
- **Connection settings** — Specify the needed connection settings. Contact your service provider for information.

Personalization

Profiles



Warning: In the offline profile you cannot make or receive any calls, including emergency calls, or use other features that require network coverage. To make calls, you must first activate the phone function by changing profiles. If the device has been locked, enter the lock code.

Select **Menu** > **Tools** > **Profiles**.

You can adjust and customize the ringing tones, alert tones, and other device tones for different events, environments, or caller groups.

To customize a profile, scroll to the desired profile in the list, and select **Options** > **Personalise**.

Define the following settings:

- **Ringing tone** — Select a ringing tone from the list, or select **Tone downloads** to open a bookmark folder containing a list of bookmarks for downloading tones using the browser. To listen to the selected tone, select **Play**. If you have two alternate phone lines in use, you can specify a ringing tone for each line.
- **Video call tone** — Select a ringing tone for video calls.
- **Say caller's name** — Activate the text-to-speech ringing tone feature. When someone from your contacts list calls you, the device sounds a ringing tone that is a combination of the spoken name of the contact and the selected ringing tone.
- **Ringing type** — Select how you want the ringing tone to alert.

- **Ringing volume** — Select the volume level of the ringing tone.
- **Message alert tone** — Select a tone for received text messages.
- **E-mail alert tone** — Select a tone for received e-mail messages.
- **IM alert tone** — Select a tone for received instant messages.
- **Vibrating alert** — Select whether you want the device to vibrate when you receive a call.
- **Keypad tones** — Set the volume level of the device keypad tones.
- **Warning tones** — Set the warning tones on or off.
- **Alert for** — You can set the device to ring only upon calls from phone numbers that belong to a selected contact group. Phone calls coming from outside that group have a silent alert.
- **Profile name** — You can give a name to a new profile or rename an existing profile. The **General** and **Offline** profiles cannot be renamed.

The **Offline** profile prevents your device from accidentally switching on, sending or receiving messages, or using Bluetooth; it also closes any Internet connection that may be in operation when the profile is selected. The **Offline** profile does not prevent you from establishing a wireless LAN connection at a later time, so comply with any applicable safety requirements when establishing and using wireless LAN connections.

To change a profile, scroll to the desired profile in the list, and select **Options** > **Activate**. If you select the **Offline** profile, you cannot send or receive messages or use WLAN to read your e-mails.

To create a new profile, select **Options** > **Create new**, and define the settings.

Themes

Select **Menu** > **Tools** > **Themes**.

You can change the look of the display of your device.

To change the look of the display, highlight the theme you want to use, and select **Options** > **Apply**.

To edit a theme, highlight the theme you want to edit, and select **Options** > **Edit**. Select **Wallpaper** to change the background image in the standby modes, or **Power saver** to use a text or the date and time as a power saver that appears on the display when no key presses have been made for a some time.

To download themes, you need to establish a network connection that allows you to download themes from Internet sources that are compatible with your device.

To download a theme, select **Theme downloads**. Enter the link from which you want to download your theme. Once the theme is downloaded you can preview, activate, or edit it.

To preview a theme, highlight the theme you want to preview, and select **Options** > **Preview**. Select **Apply** to start using the new theme.

Battery information

Your device is powered by a rechargeable battery. The full performance of a new battery is achieved only after two or three complete charge and discharge cycles. The battery can be charged and discharged hundreds of times, but it will eventually wear out. When the talk and standby times are noticeably shorter than normal, buy a new battery. Use only Nokia approved batteries, and recharge your battery only with Nokia approved chargers designated for this device.

Unplug the charger from the electrical plug and the device when not in use. Do not leave fully charged battery connected to a charger, since overcharging may shorten its lifetime. If left unused, a fully charged battery will lose its charge over time.

If the battery is completely discharged, it may take a few minutes before the charging indicator appears on the display or before any calls can be made.

Use the battery only for its intended purpose. Never use any charger or battery that is damaged.

Do not short-circuit the battery. Accidental short-circuiting can occur when a metallic object such as a coin, clip, or pen causes direct connection of the positive (+) and negative (-) terminals of the battery. (These look like metal strips on the battery.) This might happen, for example, when you carry a spare battery in your pocket or purse. Short-circuiting the terminals may damage the battery or the connecting object.

Leaving the battery in hot or cold places, such as in a closed car in summer or winter conditions, will reduce the

capacity and lifetime of the battery. Always try to keep the battery between 15°C and 25°C (59°F and 77°F). A device with a hot or cold battery may not work temporarily, even when the battery is fully charged. Battery performance is particularly limited in temperatures well below freezing.

Do not dispose of batteries in a fire as they may explode. Batteries may also explode if damaged. Dispose of batteries according to local regulations. Please recycle when possible. Do not dispose as household waste.

Nokia battery authentication guidelines

Always use original Nokia batteries for your safety. To check that you are getting an original Nokia battery, purchase it from an authorised Nokia dealer, and inspect the hologram label using the following steps:

Successful completion of the steps is not a total assurance of the authenticity of the battery. If you have any reason to believe that your battery is not an authentic, original Nokia battery, you should refrain from using it. If authenticity cannot be verified, return the battery to the place of purchase.

Authenticate hologram

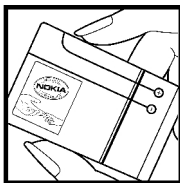

1. When looking at the hologram on the label, you should see the Nokia connecting hands symbol from one angle and the Nokia Original Enhancements logo when looking from another angle.



2. When you angle the hologram left, right, down, and up, you should see 1, 2, 3, and 4 dots on each side respectively.

What if your battery is not authentic?

If you cannot confirm that your Nokia battery with the hologram on the label is an authentic Nokia battery, please do not use the battery. The use of a battery that is not approved by the manufacturer may be dangerous and may result in poor performance and damage to your device and its enhancements. It may also invalidate any approval or warranty applying to the device.

To find out more about original Nokia batteries, visit www.nokia-asia.com/batterycheck.

Care and maintenance

Your device is a product of superior design and craftsmanship and should be treated with care. The suggestions below will help you protect your warranty coverage.

- Keep the device dry. Precipitation, humidity, and all types of liquids or moisture can contain minerals that will corrode electronic circuits. If your device does get wet, remove the battery, and allow the device to dry completely before replacing it.
- Do not use or store the device in dusty, dirty areas. Its moving parts and electronic components can be damaged.
- Do not store the device in hot areas. High temperatures can shorten the life of electronic devices, damage batteries, and warp or melt certain plastics.
- Do not store the device in cold areas. When the device returns to its normal temperature, moisture can form inside the device and damage electronic circuit boards.
- Do not attempt to open the device other than as instructed in this guide.
- Do not drop, knock, or shake the device. Rough handling can break internal circuit boards and fine mechanics.
- Do not use harsh chemicals, cleaning solvents, or strong detergents to clean the device.
- Do not paint the device. Paint can clog the moving parts and prevent proper operation.

- Use a soft, clean, dry cloth to clean any lenses, such as camera, proximity sensor, and light sensor lenses.
- Use only the supplied or an approved replacement antenna. Unauthorized antennas, modifications, or attachments could damage the device and may violate regulations governing radio devices.
- Use chargers indoors.
- Always create a backup of data you want to keep, such as contacts and calendar notes, before sending your device to a service facility.

All of the above suggestions apply equally to your device, battery, charger, or any enhancement. If any device is not working properly, take it to the nearest authorized service facility for service.

Additional safety information

Operating environment

Remember to follow any special regulations in force in any area, and always switch off your device when its use is prohibited or when it may cause interference or danger. Use the device only in its normal operating positions. This device meets RF exposure guidelines when used either in the normal use position against the ear or when positioned at least 1.5 centimeters (5/8 inches) away from the body. When a carry case, belt clip or holder is used for body-worn operation, it should not contain metal and should position the device the above-stated distance from your body.

To transmit data files or messages, this device requires a quality connection to the network. In some cases, transmission of data files or messages may be delayed until such a connection is available. Ensure that the above separation distance instructions are followed until the transmission is completed.

Parts of the device are magnetic. Metallic materials may be attracted to the device. Do not place credit cards or other magnetic storage media near the device, because information stored on them may be erased.

Medical devices

Operation of any radio transmitting equipment, including wireless phones, may interfere with the functionality of inadequately protected medical devices. Consult a

physician or the manufacturer of the medical device to determine if they are adequately shielded from external RF energy or if you have any questions. Switch off your device in health care facilities when any regulations posted in these areas instruct you to do so. Hospitals or health care facilities may be using equipment that could be sensitive to external RF energy.

Pacemakers

Pacemaker manufacturers recommend that a minimum separation of 15.3 centimeters (6 inches) be maintained between a wireless phone and a pacemaker to avoid potential interference with the pacemaker. These recommendations are consistent with the independent research by and recommendations of Wireless Technology Research. Persons with pacemakers should do the following:

- Always keep the device more than 15.3 centimeters (6 inches) from the pacemaker
- Not carry the device in a breast pocket
- Hold the device to the ear opposite the pacemaker to minimize the potential for interference.
- If you suspect interference, switch off your device, and move the device away.

Hearing aids

Some digital wireless devices may interfere with some hearing aids. If interference occurs, consult your service provider.

Vehicles

RF signals may affect improperly installed or inadequately shielded electronic systems in motor vehicles such as electronic fuel injection systems, electronic antiskid (antilock) braking systems, electronic speed control systems, and air bag systems. For more information, check with the manufacturer, or its representative, of your vehicle or any equipment that has been added.

Only qualified personnel should service the device, or install the device in a vehicle. Faulty installation or service may be dangerous and may invalidate any warranty that may apply to the device. Check regularly that all wireless device equipment in your vehicle is mounted and operating properly. Do not store or carry flammable liquids, gases, or explosive materials in the same compartment as the device, its parts, or enhancements. For vehicles equipped with an air bag, remember that air bags inflate with great force. Do not place objects, including installed or portable wireless equipment in the area over the air bag or in the air bag deployment area. If in-vehicle wireless equipment is improperly installed, and the air bag inflates, serious injury could result.

Using your device while flying in aircraft is prohibited. Switch off your device before boarding an aircraft. The use of wireless teledevices in an aircraft may be dangerous to the operation of the aircraft, disrupt the wireless telephone network, and may be illegal.

Potentially explosive environments

Switch off your device when in any area with a potentially explosive atmosphere, and obey all signs and instructions. Potentially explosive atmospheres include areas where you would normally be advised to turn off your vehicle engine. Sparks in such areas could cause an explosion or fire resulting in bodily injury or even death. Switch off the device at refueling points such as near gas pumps at service stations. Observe restrictions on the use of radio equipment in fuel depots, storage, and distribution areas; chemical plants; or where blasting operations are in progress. Areas with a potentially explosive atmosphere are often, but not always, clearly marked. They include below deck on boats, chemical transfer or storage facilities, vehicles using liquefied petroleum gas (such as propane or butane), and areas where the air contains chemicals or particles such as grain, dust, or metal powders.

Emergency calls



Important: Wireless phones, including this device, operate using radio signals, wireless networks, landline networks, and user-programmed functions. Because of this, connections in all conditions cannot be guaranteed. You should never rely solely on any wireless device for essential communications like medical emergencies.

To make an emergency call:

1. If the device is not on, switch it on. Check for adequate signal strength.

Some networks may require that a valid SIM card is properly inserted in the device.

2. Press the end key as many times as needed to clear the display and ready the device for calls.
3. Enter the official emergency number for your present location. Emergency numbers vary by location.
4. Press the call key.

If certain features are in use, you may first need to turn those features off before you can make an emergency call. Consult this guide or your service provider for more information.

When making an emergency call, give all the necessary information as accurately as possible. Your wireless device may be the only means of communication at the scene of an accident. Do not end the call until given permission to do so.

CERTIFICATION INFORMATION (SAR)

THIS MOBILE DEVICE MEETS GUIDELINES FOR EXPOSURE TO RADIO WAVES.

Your mobile device is a radio transmitter and receiver. It is designed not to exceed the limits for exposure to radio waves recommended by international guidelines. These guidelines were developed by the independent scientific organization ICNIRP and include safety margins designed

to assure the protection of all persons, regardless of age and health.

The exposure guidelines for mobile devices employ a unit of measurement known as the Specific Absorption Rate or SAR. The SAR limit stated in the ICNIRP guidelines is 2.0 watts/kilogram (W/kg) averaged over 10 grams of tissue. Tests for SAR are conducted using standard operating positions with the device transmitting at its highest certified power level in all tested frequency bands. The actual SAR level of an operating device can be below the maximum value because the device is designed to use only the power required to reach the network. That amount changes depending on a number of factors such as how close you are to a network base station. The highest SAR value under the ICNIRP guidelines for use of the device at the ear is 0.68 W/kg.

Use of device accessories and enhancements may result in different SAR values. SAR values may vary depending on national reporting and testing requirements and the network band. Additional SAR information may be provided under product information at www.nokia.com.

Index

- A**
- access points 54, 84
 - ad hoc network 61
 - answering calls 27
 - application manager 96
 - applications
 - common actions 24
 - attachments 46
 - audio files 70
 - authority certificates 97
 - automatic answer 89
- B**
- barring calls 27
 - barring password 34
 - battery
 - charge level 16
 - charging 12
 - installing 10
 - blogs 67
 - Bluetooth
 - connections 56
 - pairing 58
 - settings 57
 - bookmarks 66
 - browsing Web pages 65, 68
 - business cards 36
- C**
- cable 56
 - calculator 91
 - calendar 90
 - calling 26
 - calls
 - barring 27
 - diverting 27
 - settings 83
 - CD-ROM 20
 - cells 78
 - certificates 97
 - charging the battery 12
 - chart sheets 78
 - chat 50
 - clock 92
 - connecting to the Internet 54
 - connection manager 62
 - connection methods
 - Bluetooth 56
 - cable 56
 - infrared 60
 - modem 62
 - WLAN 61
 - connections
 - GPRS settings 54
 - WLAN settings 55, 86
 - connectors 13
 - contact groups 35
 - contact information 36
 - contacts
 - adding 35
 - copying information 36
 - default information 36
 - groups 35
 - ringing tones 36
 - copying text 19
- D**
- data
 - connections 60
 - declining calls 27
 - display
 - indicators 16
 - rotating 15
 - settings 83
 - diverting calls 27
 - documents 75
- E**
- e-mail
 - accounts 48
 - messages 44
 - replying 46
 - writing 48
 - email data roaming 63
 - ending network connections 62
 - enhancement settings 89
 - equalizer 72
- F**
- feeds 67
 - file manager 75

flash player 73

G

gallery 69

general packet radio service
See *GPRS*

GPRS

- access point settings 54
- general 60
- settings 85

H

help 23

I

IM 50

images

- add to contacts 70
- set as wallpaper 70
- zooming in or out 69

indicators 16

infrared 60

installing

- battery 10
- SIM card 10

instant messaging 50

Internet 65

- access points 54
- net call settings 84
- settings 54

J

joystick 82

K

keyguard 14

keypad lock 14

keys 13

L

landmarks 95

language 82

listening to music 72

locking

- device 14
- keypad 14

logs 28

M

mail

- See *e-mail*

media applications 69

memory 19

- monitoring 19

memory card 19, 20

menu 23

messages

- deleting 47
- e-mail 44
- folders 38
- multimedia messages 41
- picture messages 41
- special messages 53
- text messages 39

MMC 20

mobile VPN

- See *VPN*

modem 62

multimedia messages

- creating 41
- receiving 43
- replying to 43
- sending 41
- settings 44

music player 72

N

navigation 94

net calls 32

notes 91

O

outline view 76

P

packet data

- access point settings 54
- general 60
- settings 85

pairing 58

personal certificates 97

personalization 100, 101

phone

- calls 26
- language 82
- settings 82
- video calls 28

picture messages 41

playing

- music 72
- video and audio 70
- voice recordings 73

- Pop-Port connector 14
- predictive text input 18, 82
- presentations 78
- printing 81
- profiles 100

R

- RealPlayer
 - playing media clips 70
 - settings 71
- recording
 - calls 73
 - voice 73
- reduced-size MMC 20
- rejecting calls 27
- remote configuration
 - settings 98
- remote synchronization 98
- ringing tones 36
- rotating the display 15

S

- screen export 80
- security
 - device 33
- selecting text and objects 24
- selection key settings 82
- service commands 53
- settings
 - Bluetooth 57
 - calendar 91
 - calls 83
 - connection 84
 - display 83
 - general 82

- Internet 54
- message centers 39
- multimedia messages 44
- profiles 100
- remote configuration 98
- security 33
- standby 82
- text messages 40
- Web 67
- WLAN 86

SettingWizard 96

- shortcuts 16
- signal strength 16
- SIM access profile 59
- SIM card
 - installing 10
 - text messages 40
- slide shows 79
- SMS messages 39
- special messages 53
- speed dialing 26
- standby
 - mode 15
 - settings 82
- storage 19, 20
- switching device on and off 12

T

- text
 - copying 19
 - predictive input 18
 - selecting 24
 - traditional input 18
 - writing 18

- text messages
 - editing message centers 39
 - managing messages in the SIM card 40
 - replying 40
 - sending 39
 - writing 39
- themes 101
- to-do list 90
- tools folder 94
- track lists 72
- traditional text input 18
- tutorial 23

U

- USB data cable 56

V

- video calls 28
- video clips 70
- virtual private network 63
- voice commands 95
- voice dialing 95
- voice mailbox 26
- voice memos 73
- voice over IP 32
- voice recorder 73
- volume 18, 72
- VPN 63

W

- Web 65
- welcome note 82

WLAN

- access point settings 55
 - general 61
 - security settings 87
 - settings 86
- worksheets 77
- writing language 82

Nokia Care Online

The Nokia Care web support provides you with more information on our online services.

INTERACTIVE
DEMONSTRATIONS



INTERACTIVE DEMONSTRATIONS

Learn how to set up your phone for the first time, and find out more about its features. Interactive Demonstrations give step-by-step instructions on using your phone.

SOFTWARE



USER'S GUIDE

The online User's Guide contains detailed information on your phone. Remember to check regularly for updates.



SOFTWARE

Make the most of your phone with software for your phone and PC. Nokia PC Suite connects your phone and PC so you can manage your calendar, contacts, music and images, while other applications complement its use.



USER'S GUIDE

SETTINGS

Certain phone functions, such as multimedia messaging, mobile browsing and email*, may require settings before you can use them. Have them sent to your phone free of charge.



SETTINGS

*Not available on all phones.

HOW DO I USE MY PHONE?

The Set Up section, at www.nokia-asia.com/setup, helps you prepare your phone for use. Familiarise yourself with phone functions and features by referring to the Guides and Demos section at www.nokia-asia.com/guides.

HOW DO I SYNCHRONISE MY PHONE AND PC?

Connecting your phone to a compatible PC with the requisite Nokia PC Suite version from www.nokia-asia.com/pcsuite lets you synchronise your calendar and contacts.

WHERE CAN I GET SOFTWARE FOR MY PHONE?

Get more out of your phone with downloads from the Software section at www.nokia-asia.com/software.

WHERE CAN I FIND ANSWERS TO COMMON QUESTIONS?

Look up the FAQ section at www.nokia-asia.com/faq for answers to your questions on your phone and other Nokia products and services.

HOW DO I KEEP UP WITH NOKIA NEWS?

Subscribe online at www.nokia-asia.com/signup and be the first to know about the latest products and promotions. Sign up for "Nokia Connections" to receive monthly updates on latest phones and technology. Sign up for "Be The First To Know" to get exclusive previews of new phone announcements or subscribe to "Promotional Communications" for upcoming events.

Should you still require further assistance, please refer to www.nokia-asia.com/contactus.

For additional information on repair services, please visit www.nokia-asia.com/repair.

Please visit your own country site for more details:

Australia and New Zealand www.nokia.com.au/support

India www.nokia.co.in/support

Indonesia www.nokia.co.id/support

Japan www.nokia.co.jp/support

Malaysia www.nokia.com.my/support

Philippines www.nokia.com.ph/support

Singapore www.nokia.com.sg/support

Thailand www.nokia.co.th/support

If your country is not listed above, please visit www.nokia-asia.com/support.

NOKIA

Care