



INSTRUCTIONS

IMPORTANT: Read these instructions for use carefully so as to familiarize yourself with the appliance before connecting it to its gas cartridge. Keep these instructions for future reference.

Name	Model	Approval Number	Consumption	Heat Input	Injector
Compact U BBQ	SG-930	0359 359BU1030	155g/h	2.056kW/h	0.6mm

This appliance should only be used with butane gas cartridge (container) approved by EN 521.

Warning
 It may be hazardous to attempt to fit other types of gas cartridges (containers). Use outdoors only. Not for commercial use.
 Carbon monoxide caution - this appliance can produce carbon monoxide which has no odor. Using in an enclosed space (eg caravan, tent, car or mobile home) may cause suffocation or death.

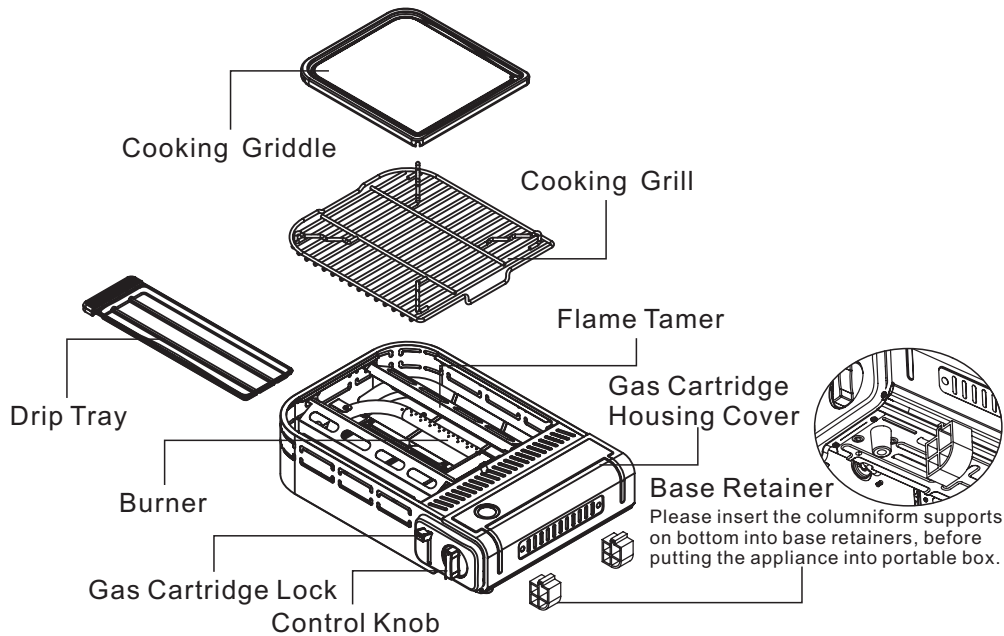

Warning
 Before connecting the gas cartridge, make sure that the cooking grill and cooking griddle have been turned and placed upright and in position.

Do not move the appliance during operation! (i.e. when the burner is alight)

WARNINGS AND IMPORTANT INFORMATIONS

- ▲ Remove transit packing before use.
- ▲ Check that seals (between the appliance and the gas cartridge) are in place and in good condition before connecting to the gas cartridge.
- ▲ Do not use this appliance if it is has damaged or worn seals.
- ▲ Do not use this appliance which is leaking, damaged or which does not operate properly.
- ▲ This appliance must be operated on a horizontal surface, unless it is not intended to operate resting on a surface.
- ▲ This appliance must be used away from flammable materials and least 400mm from adjacent surface (walls of ceilings).
- ▲ Gas cartridge shall be changed in a well-ventilated location, preferably outside, away from any sources of ignition, such as naked flames, pilots, electric fires and away from other people.
- ▲ If there is a leak (smell of gas), take it outside immediately into a well ventilated flame free location where leak may be detected and stopped.
- ▲ If you wish to check for leaks on your appliance, do it outside. Do not try to detect leaks using a flame, use soapy water.
- ▲ Caution: accessible parts may become very hot. Keep young children away from the appliance.
- ▲ Always use oven gloves when cooking or carrying out some adjustments to the barbecue.
- ▲ Once lit, do not move the barbecue until it has completely cooled, after use.
- ▲ When not in use, store the appliance in a dust free area in its box or in a plastic bag.
- ▲ If you have any queries regarding these instructions, contact your local dealer.



CARE AND MAINTENANCE



Warning

Do not attempt to tamper with this appliance, this may cause serious injury or death.
It is recommended to service every year, if the connections get block, please replace them by an authorised person.

Caution

1. Make sure that the gas cartridge is empty before cleaning.
2. Never remove safety devices and gas components.

Cleaning and Maintenance

1. Body: Wipe off with a clean cloth. If necessary, use a kitchen cleanser and finish with a dry cloth.
2. Dray Tray: After cleaning, wipe with a dry cloth.
3. Burner: Clean the burner with a hard brush, ensure that all food residue are removed from the burner

SAFETY CHARACTERISTICS

<p>Pressure-sensitive Safety Device</p> <p>The gas cartridge will be ejected automatically, when the pressure in gas cartridge become unusually high.</p>	<p>Burner</p> <p>The stainless steel burner is ideal for maximizing heat efficiency resulting in the economic use gas.</p>
<p>Cooking Griddle</p> <p>The porcelain enameled cooking griddle is especially durable and scratch resistant.</p>	<p>Gas Leak Prevention System</p> <p>If the control knob is not on vertical (OFF) position, the gas cartridge lock could not be operated.</p>
<p>Prevention System for Incorrect Placement of Gas Cartridge</p> <p>If the gas cartridge is not aligned with the keyway in position, the appliance could not be operated.</p>	<p>Dray Tray</p> <p>Spread a layer of normal sand 3-5mm in depth evenly across the tray, this will absorb grease for easy cleaning and reduce flare-up during cooking.</p>



SAFETY PRECAUTION

Do not use for purposes other than cooking. It may cause a fire hazard to use the appliance for drying clothes, burning waste, etc.

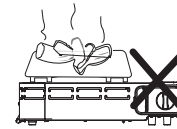

Do not allow the food to boil over. If boil over occur when cooking, turn off the grill and clean with kitchen cleanser and dry close.

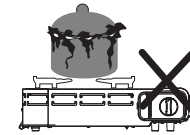

Do not use two grills side by side or oversize cooking utensils (pots, pans, griddles, etc). This may cause overheating or exploding.

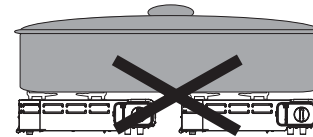

This appliance should be used in a well-ventilated place, and protected from gusty wind. Otherwise, flames may be scattered or extinguished.

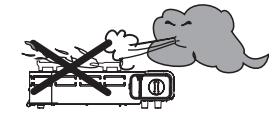

Select a well safe place before Lighting the appliance. Keep it safely away from any flammable items, and at least 400mm from walls/1000mm from ceilings.

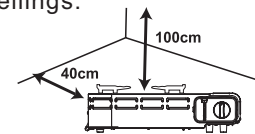

Be sure to fit the gas cartridge correctly by aligning the slot with keyway. This will avoid a gas leak.

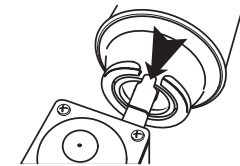

Caution Ensure that the grill and griddle are in position before use **Inspection**

1. When use the cooking grill

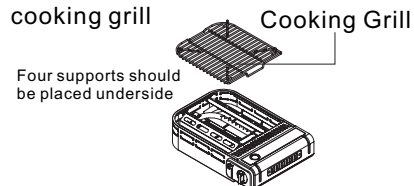

2. When use the cooking griddle

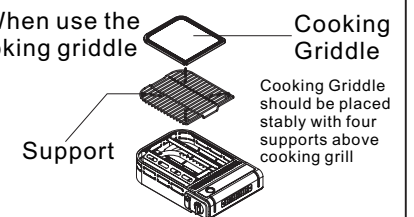

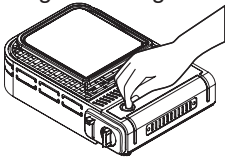
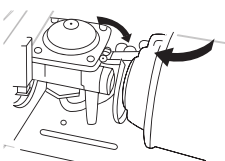
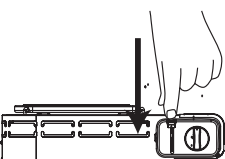
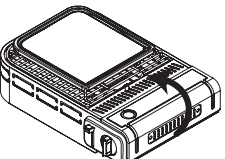
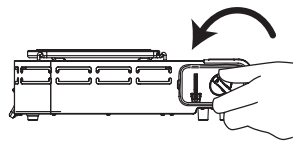
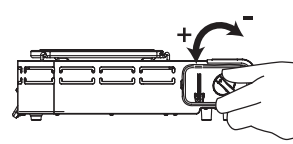
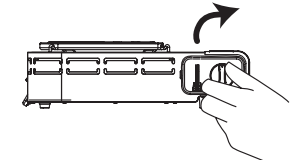
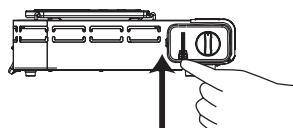

CORRECT USE-METHOD

<p>1. Ensure the cooking grill and cooking griddle are in position, and open the gas cartridge housing cover.</p> 	<p>2. Install the gas cartridge by aligning the slot and keyway.</p> 
<p>3. Push the gas cartridge lock down.</p> 	<p>4. Close the gas cartridge housing cover.</p> 
<p>5. Turn the control knob anti-clockwise until a click is heard and burner is lit.</p> 	<p>6. Place the cooking grill and cooking griddle in position, and turn the control knob to adjust flame, turn left to increase heat, turn right to decrease heat.</p> 
<p>7. When finish cooking, turn the control knob clockwise to OFF position to extinguish the flame.</p> 	<p>8. Pull up the gas cartridge lock until the gas cartridge is not locked. Take out the gas cartridge and store in a safe and suitable place.</p> 



OPERATION INSTRUCTIONS

Installing Gas Cartridge

1. Turn the control knob to OFF position. Make sure that the gas cartridge lock is on RELEASE position. The gas cartridge can not be put in position with the control knob on IGNITE position.

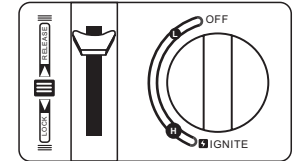

2. Check that seals are in place before connecting to the gas cartridge. Open the gas cartridge housing cover, put the gas cartridge in position. Make sure the gas outlet of cartridge fits into the gas inlet of valve inside the barbecue.

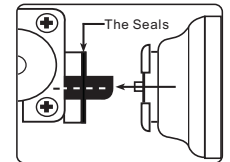

3. Push down the gas cartridge lock to Lock position before lighting the barbecue. If a hissing is heard or a gas odor is smelled, please check that if the gas cartridge is fitted correctly. Repeat the step 2 to stop gas leak.

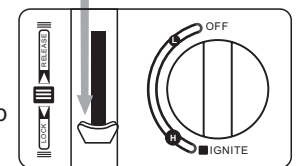

Lighting the Barbecue

1. Turn the control knob anti-clockwise to IGNITE position until a click is heard.

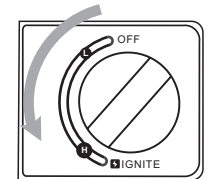

2. If the burner fails to ignite, turn the control knob back to OFF position, and repeat the above step.

Heat Control

1. The control knob can be positioned anywhere between H and L, as desire. Adjust it to suitable position for best cooking result.

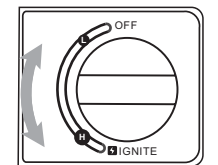

2. Always turn the control knob slowly from H to L, this can avoid flame extinguishing.

Extinguishing

1. Turn the control knob to OFF position. Make sure that the flame is completely extinguished.

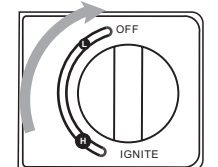



OPERATION INSTRUCTIONS

2. Turn the gas cartridge lock to RELEASE position, take out the gas cartridge.

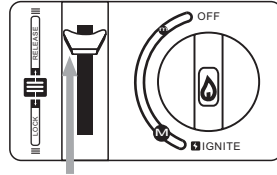

Warning

When the appliance is not in use. Turn the gas cartridge lock to RELEASE position, take out the gas cartridge and store in a safe and suitable place.

Pressure-sensitive Safety Device

If the appliance is used in a hot area such as outdoors in direct sunlight or near some source of heat, the internal gas pressure of the cartridge will increase. If it becomes more than 5-6 kg/cm² (normal pressure is 2-3 kg/cm²), the built-in safety device (pressure sensor) activates and cuts off the gas flow to extinguish the flame.

Re-lighting after the pressure sensitive safety device has been activated

1. Remove the gas cartridge from barbecue. Push in the nozzle of cartridge for a second to release pressure. Place the cartridge in a cool area for a while to lower the pressure to normal.
2. Turn the control knob to the IGNITE position to release excess gas from the valve.
3. Relight according to the OPERATION section in this manual.

CAUTION

Gas Cartridge

1. The gas cartridge should be placed safely away from any source of heat or ignition, and never under direct sunlight. Store cartridge in a cool and dry place where the temperature is less than 40 C.
2. Store cartridge in a secure place.
3. Do not subject the cartridge to impact or rough shake.
4. Do not puncture or incinerate empty cartridge.
5. Do not place cartridge in boot of a car or any unventilated location.

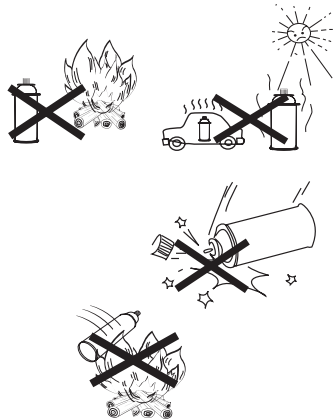

OPERATION INSTRUCTIONS

Notice for Use

1. Use only for cooking or barbecue. There is risk of fire in case of overheating or incomplete combustion, due to operate unsuitably.

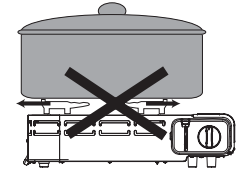

2. DO NOT use to dry clothes or use as a room heater.

3. DO NOT use items such as charcoal or briquettes for this appliance. Always keep vapour away.

Notice for Placement

1. DO NOT use the appliance in very windy conditions.

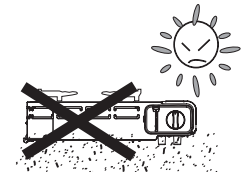

2. DO NOT use the appliance on any unstable place or beach.

3. DO NOT use the appliance close to combustible materials such as curtains. Keep at least 400mm distance away from combustible materials.

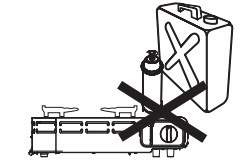

4. DO NOT use the appliance under direct sunlight, always use in shadow or cool place.

5. DO NOT use the appliance in enclosed spaces. Adequate ventilation should be supplied.



Warning

Before lighting the appliance, make sure that the cooking grill and cooking griddle have been turned and placed upright and in position.



LEAK TESTING

LEAK TESTING

Always perform a leak test in a well-ventilated area. Always wipe the mixed solution (½ water and ½ liquid detergent / soap) from all connection after leak test.

Step 1 - Confirm control knob is in the OFF position.

Step 2 - Install the gas cartridge in position.

Step 3 - Push the gas cartridge lock down.

Step 4 - Check for leaks by brushing a solution of ½ water and ½ liquid detergent / soap over all the gas system joints, including all valve connections, hose connections.

Step 5 - NEVER USE AN OPEN FLAME to test for leaks at any time.

Step 6 - If bubbles form over any of the joints there is a leak.

Turn off the gas supply at the gas bottle

Re-tighten all joints

Repeat test

If bubbles form again do not use the barbecue and contact your local Outback distributor for assistance.

The following linedrawing is for easier test for your reference.

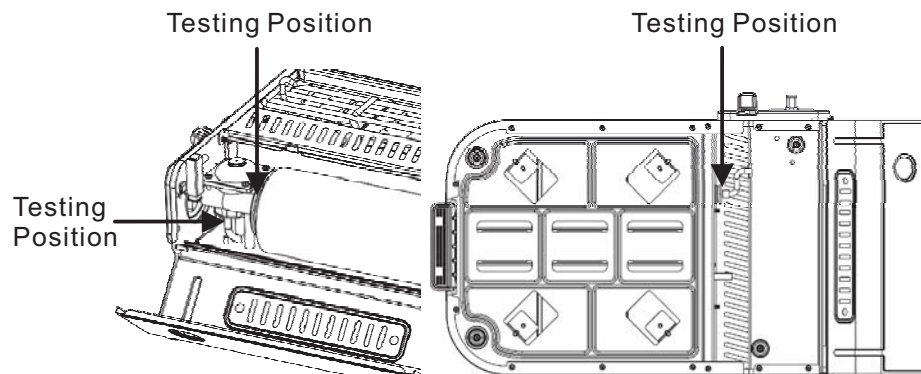

TROUBLESHOOTING

PROBLEM	Can not ignite	Can not burn	Unstable flame	Uneven flame	Low flame	Gas leak	Flame extinguish automatically	Continued burning after turning off	SOLUTION
Lack of fuel	●	●			●		●		Replace gas cartridge
Spark point dirty	●								Wipe off dirt
Obstruction in burner	●	●	●	●					Clean the burner
imperfect gas cartridge alignment	●	●	●		●	●			Reset correctly
Use of unsuitable fuel	●	●	●	●	●				Use of correct fuel
Faulty ignition system	●					●		●	Request for inspection or service
High pressure in gas cartridge							●		Cool down gas cartridge
Functioning of safety stop mechanism	●						●		Check and reset gas cartridge
Spark point not in position	●								Reset spark point, keep 2mm from burner

In the unlikely event that you experience problems with this barbecue, please contact:
 Customer Service Outback UK Unit 2 Farleigh Hill Tovil Maidstone Kent ME15 6RG
 Tel: 01622 671771 Fax: 01622 673101
 e-mail: customerservice@outbackuk.com
 website: www.outbackuk.com