

# First Alert® User's Manual

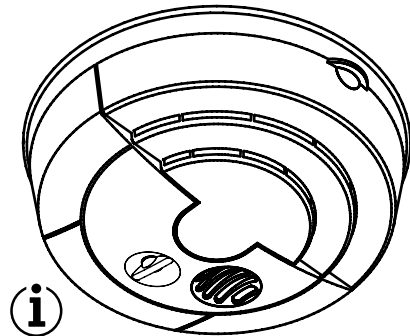

**i** Smoke Alarm With Silence Feature  
Cat. SA87B, SA87C

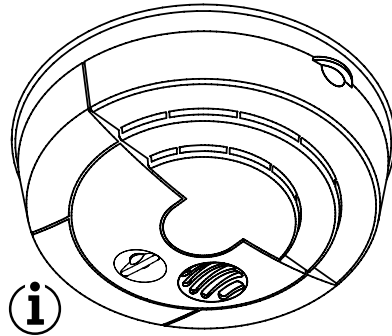

**i** Smoke Alarm With Silence Feature  
and Long-Life Lithium Power  
Cat. SA97B, SA97C

**i** Ionization smoke alarms are generally more effective at detecting flaming fires which consume combustible materials rapidly and spread quickly. Sources of these fires may include paper burning in a wastebasket, or a grease fire in the kitchen.

**P** Photoelectric smoke alarms are generally more effective at detecting smoldering fires which smolder for hours before bursting into flame. Sources of these fires may include cigarettes burning in couches or bedding.

**For maximum protection, use both types of smoke alarms on each level of your home.**

M06-2008-005 8/99



Model  
SA87B  
SA97B

## INSIDE THIS MANUAL

### IMPORTANT! PLEASE READ CAREFULLY AND SAVE.

This user's manual contains important information about your smoke alarm's operation. If you are installing this smoke alarm for use by others, you must leave this manual—or a copy of it—with the end user.

THIS USER'S MANUAL HAS BEEN RESIZED TO PRINT OUT ON 8-1/2 x 11" PAGES.  
BLACK page numbers reference the original printed document.

RED page numbers reference this web version.

Other Features Of Smoke Alarms	1
Special Compliance Considerations	1
Limitations Of Smoke Alarms	1
Where To Install Smoke Alarms	2
Where Not To Install Smoke Alarms	2
Protecting Your Family From Fire	2/3
What To Do In Case Of Fire	3
Important! Read Before Installing This Smoke Alarm	3
How To Install This Smoke Alarm	3
Weekly Testing	3/4
Regular Maintenance	4
If This Smoke Alarm Goes Into Alarm	4
If This Smoke Alarm Is Not Working Properly	4/5
10-Year Limited Warranty	4/5

All Rights Reserved. ©1999 BRK Brands, Inc.  
BRK Brands, Inc., 3901 Liberty Street Road, Aurora, IL 60504-8122  
Consumer Affairs: Monday-Friday, 7:30am-5pm (Central Time): (800) 323-9005 • Internet: www.firstalert.com

## OTHER FEATURES OF SMOKE ALARMS

**Battery (DC) operated smoke alarms:** Provide protection even when electricity fails, provided the batteries are fresh and correctly installed. Units are easy to install, and do not require professional installation.

**AC powered smoke alarms:** Can be interconnected so if one unit senses smoke, all units alarm. They do not operate if electricity fails. Units must be installed by a qualified electrician.

**AC/DC powered smoke alarms (AC with battery back-up):** Can be interconnected so if one unit senses smoke, all units alarm. They will operate if electricity fails, provided the batteries are fresh and correctly installed. Units must be installed by a qualified electrician.

**Smoke alarms for the hearing impaired: *Special purpose smoke alarms should be installed for the hearing impaired.*** They include a visual alarm and an audible alarm horn, and meet the requirements of the Americans With Disabilities Act. These units can be interconnected so if one unit senses smoke, all units alarm. They do not operate if electricity fails. Units must be installed by a qualified electrician. **First Alert®** smoke alarm model SA100B is an AC powered unit that has an 85 decibel alarm and a 177 candela strobe light, which flashes rapidly when the unit is in alarm.

All these smoke alarms are designed to provide early warning of fires if located, installed and cared for as described in the user's manual, and if smoke reaches them. If you are unsure which type of smoke alarm to install, refer to Chapter 2 of the National Fire Protection Association (NFPA) Standard 72 (National Fire Alarm Code) and NFPA 101 (Life Safety Code). National Fire Protection Association, One Batterymarch Park, Quincy, MA 02269-9101. Local building codes may also require specific units in new construction or in different areas of the home.

## SPECIAL COMPLIANCE CONSIDERATIONS

This smoke alarm alone is not a suitable substitute for complete fire detection systems in places housing many people—like apartment buildings, condominiums, hotels, motels, dormitories, hospitals, long-term health care facilities, nursing homes, day care facilities, or group homes of any kind—even if they were once single-family homes. It is not a suitable substitute for complete fire detection systems in warehouses, industrial facilities, commercial buildings, and special-purpose non-residential buildings which require special fire detection and alarm systems. Depending on the building codes in your area, this smoke alarm may be used to provide additional protection in these facilities.

**The following information applies to all four types of buildings listed below:** In new construction, most building codes require the use of AC or AC/DC powered smoke alarms only. In existing construction, AC, AC/DC, or DC powered smoke alarms can be used as specified by local building codes. Refer to NFPA 101 (Life Safety Code) or NFPA 72 (National Fire Alarm Code), local building codes, or consult your Fire Department for detailed fire protection requirements in buildings not defined as "households."

**1. Single-Family Residence:** Single family home, townhouse. It is recommended smoke alarms be installed on every level of the home, in every bedroom, and in each bedroom hallway.

**2. Multi-Family or Mixed Occupant Residence:** Apartment building, condominium. This smoke alarm is suitable for use in individual apartments or condos, provided a primary fire detection system already exists to meet fire detection requirements in common areas like lobbies, hallways, or porches. Using this smoke alarm in common areas may not provide sufficient warning to all residents or meet local fire protection ordinances/regulations.

**3. Institutions:** Hospitals, day care facilities, long-term health care facilities. This smoke alarm is suitable for use in individual patient sleeping/resident rooms, provided a primary fire detection system already exists to meet fire detection requirements in common areas like lobbies, hallways, or porches. Using this smoke alarm in common areas may not provide sufficient warning to all residents or meet local fire protection ordinances/regulations.

**4. Hotels and Motels:** Also boarding houses and dormitories. This smoke alarm is suitable for use inside individual sleeping/resident rooms, provided a primary fire detection system already exists to meet fire detection requirements in common areas like lobbies, hallways, or porches. Using this smoke alarm in common areas may not provide sufficient warning to all residents or meet local fire protection ordinances/regulations.

## LIMITATIONS OF SMOKE ALARMS

Smoke alarms have played a key role in reducing deaths resulting from home fires worldwide. However, like any warning device, smoke alarms can only work if they are properly located, installed, and maintained, and if smoke reaches them. They are not foolproof.

**Smoke alarms cannot work without power.** Battery operated units cannot work if the batteries are missing, disconnected or dead, if the wrong type of batteries are used, or if the batteries are not installed correctly. AC units cannot work if the AC power is cut off for any reason (open fuse or circuit breaker, failure along a power line or at a power station, electrical fire that burns the electrical wires, etc.). If you are concerned about the limitations of battery or AC power, install both types of units.

**Smoke alarms cannot detect fires if the smoke does not reach them.** Smoke from fires in chimneys or walls, on roofs, or on the other side of closed doors may not reach the sensing chamber and set off the alarm. That is why one unit should be installed inside each bedroom or sleeping area—especially if bedroom or sleeping area doors are closed at night—and in the hallway between them.

**Smoke alarms may not detect fire on another floor or area of the home.** For example, a stand-alone unit on the second floor may not detect smoke from a basement fire until the fire spreads. This may not give you enough time to escape safely. That is why recommended minimum protection is at least one unit in every sleeping area, and every bedroom on every level of your home. Even with a unit on every floor, stand-alone units may not provide as much protection as interconnected units, especially if the fire starts in a remote area. Some safety experts recommend installing interconnected AC powered units with battery back-up (see "Other Features Of Smoke Alarms") or professional fire detection systems, so if one unit senses smoke, all units alarm. Interconnected units may provide earlier warning than stand-alone units since all units alarm when one detects smoke.

**Smoke alarms may not be heard.** Though the alarm horn in this unit meets or exceeds current standards,

it may not be heard if: 1) the unit is located outside a closed or partially closed door, 2) residents recently consumed alcohol or drugs, 3) the alarm is drowned out by noise from stereo, TV, traffic, air conditioner or other appliances, 4) residents are hearing impaired or sound sleepers. Special purpose units, like those with visual and audible alarms, should be installed for hearing impaired residents.

**Smoke alarms may not have time to alarm before the fire itself causes damage,** injury, or death, since smoke from some fires may not reach the unit immediately. Examples of this include persons smoking in bed, children playing with matches, or fires caused by violent explosions resulting from escaping gas.

**Smoke alarms are not foolproof.** Like any electronic device, smoke alarms are made of components that can wear out or fail at any time. You must test the unit weekly to ensure your continued protection. Smoke alarms cannot prevent or extinguish fires. They are not a substitute for property or life insurance.

**Smoke alarms have a limited life.** The unit should be replaced immediately if it is not operating properly. It is recommended you replace a smoke alarm after 10 years from date of manufacture. See back of smoke alarm for manufacture date.

## WHERE TO INSTALL SMOKE ALARMS

### INSTALLING SMOKE ALARMS IN SINGLE-FAMILY RESIDENCES

The National Fire Protection Association (NFPA), requires one smoke alarm on every floor, in every sleeping area, and in every bedroom. In new construction, the smoke alarms must be AC powered and interconnected. See "Agency Placement Recommendations" for details. For additional coverage, it is recommended that you install a smoke alarm in all rooms, halls, storage areas, finished attics, and basements, where temperatures normally remain between 40°F (4°C) and 100°F (38°C). Make sure no door or other obstruction could keep smoke from reaching the smoke alarms.

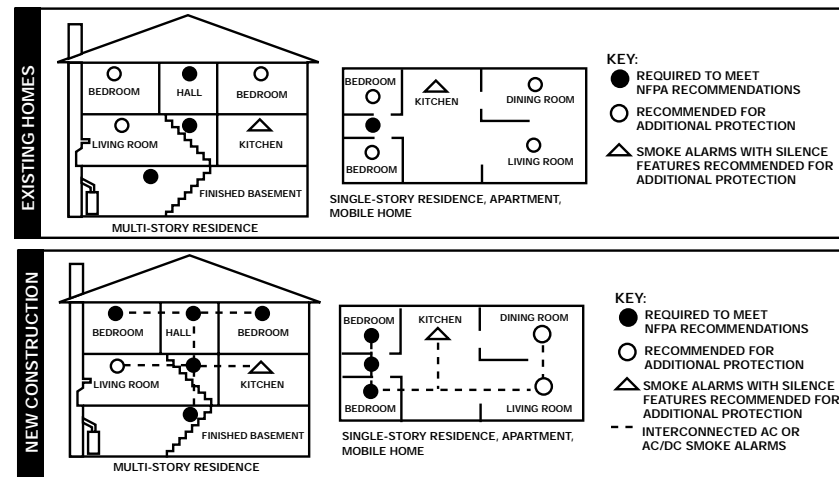

#### More specifically, install smoke alarms:

- On every level of your home, including finished attics and basements.
- Inside every bedroom, especially if people sleep with the door partly or completely closed.
- In the hall near every sleeping area. If your home has multiple sleeping areas, install a unit in each. If a hall is more than 40 feet (12 meters), install a unit at each end.
- At the top of the first-to-second floor stairway, and at the bottom of the basement stairway.

### IMPORTANT!

Specific requirements for smoke alarm installation vary from state to state and from region to region. Check with your local Fire Department for current requirements in your area. If you install AC or AC/DC units, it is recommended they be interconnected for added protection.

### INSTALLING SMOKE ALARMS IN MOBILE HOMES AND RVs

#### ⚠ WARNING!

Test units used in RVs after the vehicle has been in storage, before every trip, and once a week while in use. Failure to test units used in RVs as described may remove your protection.

For minimum security install one smoke alarm as close to each sleeping area as possible. For more security, put one unit in each room. Many older mobile homes (especially those built before 1978) have little or no insulation. If your mobile home is not well insulated, or if you are unsure of the amount of insulation, it is important to install units on inside walls only. Smoke alarms should be installed where temperatures normally remain between 40°F (4°C) and 100°F (38°C).

### AGENCY PLACEMENT RECOMMENDATIONS

#### IMPORTANT!

This equipment should be installed in accordance with the National Fire Protection Association's Standard 72. National Fire Protection Association, One Batterymarch Park, Quincy, MA 02269-9101. **Additional local building and regulatory codes may apply in your area. Always check compliance requirements before beginning any installation.**

#### NFPA Standard 72 Section 2-2.1.1.1

2-2.1.1.1 Smoke alarms shall be installed outside of each separate sleeping area in the immediate vicinity of the bedrooms and on each additional story of the family living unit, including basements and excluding crawl spaces and unfinished attics. In new construction a smoke alarm shall also be installed in each sleeping room. Chapter 2 also reads as follows: 2-2.2.1: In new construction, where more than one smoke alarm is required by 2-2.1, alarms shall be so arranged that operation of any one alarm shall cause the operation of all alarms within the dwelling.

A-2.5.2.1 Smoke Detection-Are More Smoke Alarms Desirable? The required number of smoke alarms might not provide reliable early warning protection for those areas separated by a door from the areas protected by the required smoke alarms. For this reason, it is recommended that the householder consider the use of additional smoke alarms for those areas for increased protection. The additional areas include the basement, bedrooms, dining room, furnace room, utility room, and hallways not protected by the required smoke alarms. The installation of smoke alarms in kitchens, attics (finished or unfinished), or garages is not normally recommended, as these locations occasionally experience conditions that can result in improper operation.

#### California State Fire Marshall

Early warning detection is best achieved by the installation of fire detection equipment in all rooms and areas of the household as follows: A smoke alarm installed in each separate sleeping area (in the vicinity, but outside bedrooms), and heat or smoke alarms in the living rooms, dining rooms, bedrooms, kitchens, hallways, finished attics, furnace rooms, closets, utility and storage rooms, basements, and attached garages.

### WHERE NOT TO INSTALL SMOKE ALARMS

#### For best performance, do not install the unit:

- Where combustion particles are produced. Combustion particles form when something burns. Areas to avoid include poorly ventilated kitchens, garages, and furnace rooms. Keep units at least 20 feet (6 meters) from the sources of combustion particles (stove, furnace, water heater, space heater) if possible. Ventilate these areas as much as possible.
- In air streams near kitchens. Air currents can draw cooking smoke into the sensing chamber of a smoke alarm near the kitchen.
- In very damp, humid or steamy areas, or directly near bathrooms with showers. Keep units at least 10 feet (3 meters) away from showers, saunas, dishwashers, etc.
- Where the temperatures are regularly below 40°F (4°C) and over 100°F (38°C), including unheated buildings, outdoor rooms, porches, or unfinished attics or basements.
- In very dusty, dirty, or greasy areas. Do not install a smoke alarm directly over the stove or range. Clean a laundry room unit frequently to keep it free of dust or lint.
- Near fresh air vents, ceiling fans, or in very drafty areas. Drafts can blow smoke away from the unit, preventing it from reaching the sensing chamber.
- In insect infested areas. Insects can clog openings to the sensing chamber and cause unwanted alarms.
- Less than 12 inches (305mm) away from fluorescent lights. Electrical "noise" can interfere with the sensor.
- In "dead air" spaces (see "Avoiding Dead Air Spaces" below).

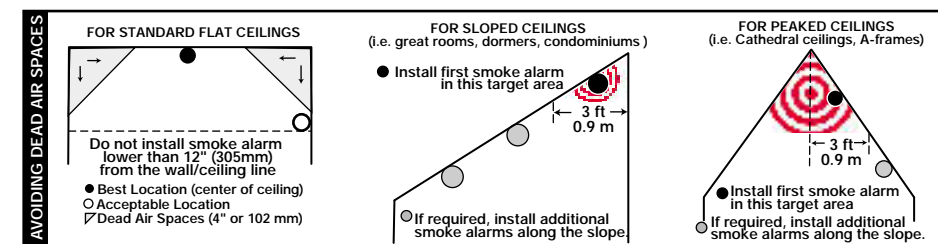

"Dead air" spaces may prevent smoke from reaching the smoke alarm. To avoid dead air spaces, follow the installation recommendations below.

**On ceilings,** install smoke alarms as close to the center of the ceiling as possible. If this is not possible, install the smoke alarm at least 4 inches (102mm) from the wall or corner.

**For wall mounting** (if allowed by building codes), the top edge of smoke alarms should be placed between 4 inches (102mm) and 12 inches (305mm) from the wall/ceiling line, below typical "dead air" spaces.

**On a peaked, gabled, or cathedral ceiling,** install the first smoke alarm within three feet (0.9m) of the peak of the ceiling, measured horizontally. Additional smoke alarms may be required depending on the length, angle, etc. of the ceiling's slope. Refer to NFPA 72 for details on requirements for sloped or peaked ceilings.

## PROTECTING YOUR FAMILY FROM FIRE

Putting up smoke alarms is one step in protecting your family from fires. You must also reduce the chance a fire will start in your home, and have a plan for escaping safely if one does. To have a good fire safety program, you must:

Develop a family escape plan and practice it with everyone in your family, including small children. 1) Draw a floor plan of your home and identify at least two exits from each room and one way to get out of each bedroom without opening the door; 2) Decide on a meeting place a safe distance from home, and make sure everyone knows to wait there; 3) Know where to go to call the Fire Department from outside the home; 4) Make sure everyone—including all children—know what the alarm signal means and how to react to it. Teach them they must be prepared to leave the home by themselves if needed; 5) Hold fire drills every 6 months and practice how to escape safely. Show children how to check if doors are hot before opening them. Show them how to use an alternate exit if a door is hot and shouldn't be opened. Teach them to stay close to the floor and crawl if necessary.

Install at least one smoke alarm on every level of your home, in every bedroom, and in every sleeping area. Keep alarms clean, and test them weekly. Replace smoke alarms immediately if they are not working properly. Smoke alarms that do not work cannot alert you to a fire.

Keep at least one working fire extinguisher on every floor, and an additional one in the kitchen. Have fire escape ladders or other reliable means of escape from an upper floor in case stairs are blocked.

Follow safety rules, and prevent hazardous situations: 1) Use smoking materials properly. Never smoke in bed. 2) Keep matches or lighters away from children; 3) Store flammable materials in proper containers; 4) Keep electrical appliances in good condition and don't overload electrical circuits; 5) Keep stoves, barbecue grills, fireplaces and chimneys grease- and debris-free; 6) Never leave anything cooking on the stove unattended; 7) Keep portable heaters and open flames, like candles, away from flammable materials; 8) Don't let rubbish accumulate.

## WHAT TO DO IN CASE OF FIRE

- Don't panic; stay calm. Follow your family escape plan. Your safe escape may depend on thinking clearly and remembering what you have practiced.
- Get out of the house as quickly as possible. Don't stop to get dressed or collect anything.
- Feel doors with the back of your hand before opening them to see if they are hot. If a door is cool, open it slowly. Don't open a hot door—use an alternate escape route.
- Cover your nose and mouth with a cloth (preferably wet). Take short, shallow breaths.
- Keep doors and windows closed, unless you need to escape through them.
- Meet at your planned meeting place outside your home, and do a head count to make sure everybody got out safely.
- Call the Fire Department as soon as possible from outside. Give your address, then your name.
- Never go back inside a burning building for any reason.

Contact your Fire Department for ideas on making your home safer and on creating your own family escape plan.

## IMPORTANT! READ BEFORE INSTALLING SMOKE ALARM

Read "Where To Install Smoke Alarms" and "Where Not To Install Smoke Alarms" before beginning. This unit monitors the air, and when smoke reaches its sensing chamber, it alarms. It can give you more time to escape before fire spreads. This unit can ONLY give an early warning of developing fires if it is installed, maintained and located where smoke can reach it, and where all residents can hear it, as described in this manual. This unit will not sense gas, heat, or flame. It cannot prevent or extinguish fires.

### ⚠ WARNING!

- This unit will not alert hearing impaired residents. It is recommended that you install special units which use devices like flashing strobe lights to alert hearing impaired residents.
- Do not connect this unit to any other alarm or auxiliary device. It is a single-station unit that cannot be linked to other devices. Connecting anything else to this unit may prevent it from working properly.

### ⚠ CAUTION!

- Do not install this unit over an electrical junction box. Air currents around junction boxes can prevent smoke from reaching the sensing chamber and prevent the unit from alarming. Only AC powered units are intended for installation over junction boxes.
- Do not stand too close to the unit when the alarm is sounding. It is loud to wake you in an emergency. Exposure to the horn at close range may harm your hearing. When testing the unit, step back when the horn starts sounding.
- Do not paint over the unit. Paint may clog the openings to the sensing chamber and prevent the unit from operating properly.

## HOW TO INSTALL THIS SMOKE ALARM

### ⚠ CAUTION!

- The battery was shipped "backwards" in the smoke alarm to keep it fresh. The smoke alarm cannot work until you remove the battery and reinstall it in the correct position (Follow polarity markings in the battery compartment).
- This smoke alarm has a battery guard which prevents it from closing unless a battery is installed. This warns you the unit will not operate without a battery.

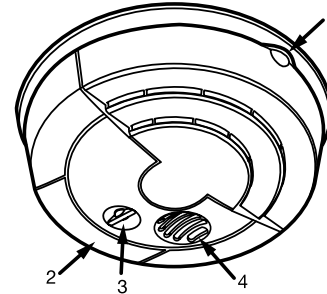

Cover of Smoke Alarm

1	"Open Here" tab	3	Test button and power/alarm indicator
2	Cover hinge	4	Silence button

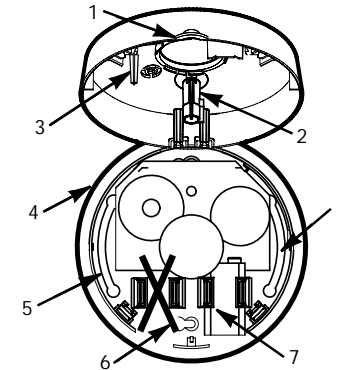

Parts of Smoke Alarm (Cover Open)

1	"Open Here" tab
2	Test button and power/alarm indicator
3	Silence button
4	Smoke alarm base
5	Mounting slots
6	<b>DO NOT install any battery here!</b>
7	Install 9V battery here



### To install this smoke alarm, follow these steps:

This unit is designed to be mounted on the ceiling, or on the wall if necessary.

#### Tools you will need:

- Pencil
- Drill with 3/16" (5 mm) drill bit
- Standard/Flathead screwdriver
- Hammer

1. Hold base firmly and pull up on cover tab marked "OPEN HERE." This will open the hinged cover. The cover may unsnap from the base if it's opened too far. This will not damage the unit—the cover hinge snaps back into place easily.
2. Hold the smoke alarm base against the ceiling (or wall) and make a mark at the center of each of the mounting slots with a pencil.
3. Put the unit where it won't get covered with dust when you drill the mounting holes.
4. Using a 3/16" (5 mm) drill bit, drill a hole through each pencil mark.
5. Insert the plastic screw anchors (in the plastic bag with screws) into the holes. Tap the screw anchors gently with a hammer, if necessary, until they are flush with the ceiling or wall.
6. Tighten the screws (provided) into the screw anchors, then loosen them two turns.
7. Fit the smoke alarm over the screw heads as shown. Close cover.
8. If the smoke alarm cover does not line up the way you want it, rotate the base and re-tighten the screws.
9. Activate the battery. With the cover open, remove and reinstall the battery so the terminals on the battery match the terminals on the smoke alarm. Match "+" to "+" and "-" to "-." Push the battery in until it snaps in securely and cannot be shaken loose. If the battery is not snapped in completely, the unit cannot receive battery power. The smoke alarm may beep briefly when you install the battery—this is normal. Once the battery is installed, the red power indicator light (behind the test button) will flash once a minute to show you the smoke alarm is working.
10. Close the cover all the way.
11. Test the smoke alarm. See "Weekly Testing."

### WEEKLY TESTING

**⚠ WARNING!**  
NEVER use an open flame of any kind to test this unit. You might accidentally damage or set fire to the unit or to your home. The built-in test switch accurately tests the unit's operation as required by Underwriters Laboratories, Inc. (UL). If you choose to use an aerosol smoke product to test the smoke alarm, be certain to use one that has been Listed to Underwriters Laboratories, Inc. Safety Standards, and use it only as directed. Use of non-UL Listed products or improper use of UL Listed products may affect the smoke alarm's sensitivity.

It is important to test this unit every week to make sure it is working properly. Using the test button is the recommended way to test this smoke alarm. Press and hold the test button on the cover of the unit for 5-20 seconds, or until the alarm sounds (the unit may continue to alarm for a few seconds after you release the button). If it does not alarm, make sure the unit is receiving power and test it again. If it still does not alarm, replace it immediately. During testing you will hear a loud, repeating horn pattern: 3 beeps, pause, 3 beeps, pause.

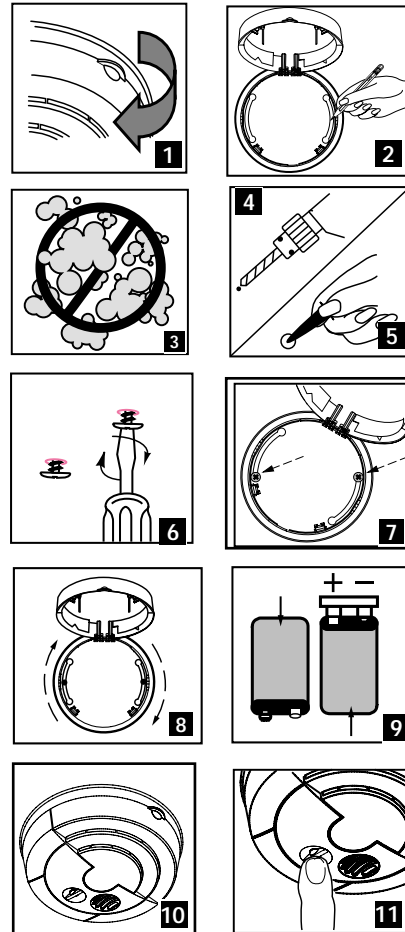

### REGULAR MAINTENANCE

This unit has been designed to be as maintenance free as possible, but there are a few simple things you must do to keep it working properly.

- Test it at least once a week.
- Test units used in RVs after the vehicle has been in storage, before every trip, and once a week while in use. Failure to test units used in RVs as described may remove your protection.
- Clean the smoke alarm at least once a month: gently vacuum off any dust using your household vacuum's soft brush attachment. 1. Open the cover and disconnect the battery. 2. GENTLY vacuum the inside of the cover and the sensor chamber. 3. Reconnect the battery. 4. Close the smoke alarm, and vacuum the outside of the cover. 5. Test the smoke alarm. **Never use water, cleaners or solvents since they may damage the unit.**
- Relocate the unit if it sounds frequent unwanted alarms. See "Where Not To Install Smoke Alarms."
- When the battery becomes weak, the smoke alarm unit will "chirp" about once a minute (the low battery warning). This low battery warning should last for 30 days, but you should replace the battery immediately to continue your protection.

### Choosing a replacement battery:

**⚠ WARNING!**  
Use only the replacement batteries listed. The unit may not operate properly with other batteries. Never use rechargeable batteries since they may not provide a constant charge.

Your smoke alarm requires one standard 9V battery. The following batteries are acceptable as replacements: Eveready (Energizer) #522, #1222, #216; Duracell #MN1604; Gold Peak #1604P, #1604S; Rayovac 1604, D1604. You may also use a Lithium battery like the Ultralife U9VL-J for longer service life between battery changes. These batteries are available at many local retail stores.

### IMPORTANT!

Most carbon zinc batteries have an average service life of 1 year; most alkaline batteries have an average service life of 1-2 years; most Lithium batteries have an average service life of 6-10 years. Actual service life depends on the smoke alarm and the environment in which it is installed. All the batteries specified above are acceptable replacement batteries for this unit. Regardless of the manufacturer's suggested battery life, you MUST replace the battery immediately once the unit starts "chirping" (the "low battery warning").

### Cat. Nos. SA97B and SA97C ONLY:

These models were shipped with a 10-Year Extended Life Lithium battery. When you replace the original battery, you must replace it with a 10-Year Extended Life Lithium battery for continued long-life power between battery changes.

### IF THIS SMOKE ALARM GOES INTO ALARM

- ⚠ WARNING!**
- If the unit alarms and you are not testing the unit, it is warning you of a potentially dangerous situation that requires your immediate attention. NEVER ignore any alarm. Ignoring the alarm may result in injury or death. If the unit alarms and you are not absolutely certain of the source of the smoke, get everyone out of the house immediately.
- ⚠ WARNING!**
- Never remove the batteries from a battery operated smoke alarm to stop an unwanted alarm (caused by cooking smoke, etc.). Removing the batteries disables the alarm so it cannot sense smoke, and removes your protection. Instead use the silence feature, then open a window or fan the smoke away from the unit. The alarm will reset automatically.

### Responding To An Alarm

During an alarm, you will hear a loud, repeating horn pattern: 3 beeps, pause, 3 beeps, pause.

If the unit alarms and you are not absolutely certain of the source of the smoke, get everyone out of the house immediately. Stay calm and follow your family escape plan. Stay as low to the ground as possible, and cover your mouth with a damp cloth. Never open a door before testing to see if it is hot. Call the Fire Department from outside, and give them your address, then name. Read "What To Do In Case Of Fire" for more information.

If the unit alarms and you are certain that the source of smoke is not a fire—cooking smoke or an extremely dusty furnace, for example—use the silence feature to quiet the alarm, then open a nearby window or door and fan the smoke away from the unit. This will silence the alarm, and once the smoke clears the unit will reset automatically. If the unit will not silence and no heavy smoke is present, or if it stays in the silence mode continuously ("chirps" for longer than 30 minutes), the unit should be replaced immediately.

### Using the Silence Feature

The silence feature can temporarily quiet an unwanted alarm for several minutes. To use this feature, press the "Push to Silence" button on the cover. The alarm will "chirp" about once a minute (for up to 15 minutes) to remind you the alarm has been silenced. The "chirping" will stop when the unit returns to normal operation.

**⚠ WARNING!**

**The silence feature does not disable the unit—it makes it temporarily less sensitive to smoke. For your safety, if smoke around the unit is dense enough to suggest a potentially dangerous situation, it will stay in alarm, or may re-alarm quickly. If you do not know the source of the smoke, do not assume it is an unwanted alarm. Not responding to an alarm can result in property loss, injury or death.**

### IF YOUR SMOKE ALARM IS NOT WORKING PROPERLY

**IMPORTANT!**

Smoke alarms may not operate properly because of dead, missing or weak batteries, a build-up of dirt, dust or grease on the smoke alarm cover, or installation in an improper location. Clean the smoke alarm as described in "Regular Maintenance," and install a fresh battery, then test the smoke alarm again. If it fails to test properly when you use the test button, or if the problem persists, replace the smoke alarm immediately.

Problem...	You should...
Smoke alarm alarms when no smoke is visible.	<ul style="list-style-type: none"> <li>• Clean the smoke alarm. (See "Regular Maintenance.")</li> <li>• Check the location of the smoke alarm. (See "Where To Install Smoke Alarms.")</li> </ul>
You experience frequent unwanted alarms (like in response to cooking smoke).	<ul style="list-style-type: none"> <li>• Check the location of the smoke alarm. (See "Where To Install Smoke Alarms.")</li> </ul>
Smoke alarm "chirps" intermittently.	<ul style="list-style-type: none"> <li>• Check that the battery is installed correctly and is working properly. (See "How to Install This Smoke Alarm" and "Weekly Testing.")</li> <li>• Check the location of the smoke alarm. (See "Where To Install Smoke Alarms.")</li> <li>• Clean the smoke alarm. (See "Regular Maintenance.")</li> </ul>
Smoke alarm "chirps" about once a minute.	<ul style="list-style-type: none"> <li>• Replace the battery. (See "Regular Maintenance.")</li> </ul>
Alarm horn doesn't sound during testing.	<ul style="list-style-type: none"> <li>• Check that the battery is installed correctly and is working properly. (See "How to Install This Smoke Alarm" and "Weekly Testing.")</li> </ul>
Alarm horn will not silence when you push the Silence button	<ul style="list-style-type: none"> <li>• <b>Do not ignore the alarm!</b> Smoke present may be too dense, indicating an emergency situation</li> </ul>

If the smoke alarm is still not operating properly, and it is still under warranty, send it, shipping prepaid, along with original purchase receipt (or write down date purchased), to: BRK Brands, Inc., Attn.: Consumer Affairs, 3920 Enterprise Court, Aurora, IL 60504-8132. Enclose a note in the package describing what is wrong with the unit.

**⚠ WARNING!**

**Do not try to fix the unit yourself—this will void your warranty!**

### 10-YEAR LIMITED WARRANTY

**Coverage:** BRK Brands, Inc. warrants its enclosed smoke alarm to be free from defects in materials and workmanship under normal use for a period of ten years from the date of purchase. During the first year after the date of purchase, BRK Brands, Inc. will replace any defective smoke alarm without charge. During the next nine years, BRK Brands, Inc. will replace any defective smoke alarm at a charge to you not to exceed BRK Brands, Inc.'s cost. This is your exclusive warranty.

This warranty is valid for the original retail purchaser from the date of initial retail purchase and is not transferable. Keep the original sales receipt. Proof of purchase is required to obtain warranty performance. Dealers, service centers, or retail stores selling this product do not have the right to alter, modify or any way change the terms and conditions of this warranty. In new construction, if your smoke alarms were installed by a contractor, this warranty is valid for the homeowner at the time of installation from the date of original installation and is not transferable.

This warranty does not cover normal wear of parts or damage resulting from any of the following: negligent use or misuse of the product, use on improper voltage, current or battery, use contrary to the operating instructions, disassembly, repair or alteration by anyone other than BRK Brands, Inc. Further, the warranty does not cover acts of God, such as fire, flood, hurricanes and tornadoes.

BRK Brands, Inc. shall not be liable for any incidental or consequential damages caused by the breach of any express or implied warranty. Except to the extent prohibited by applicable law, any implied warranty of merchantability or fitness for a particular purpose is limited in duration for 10 years. Some states, provinces, or jurisdictions do not allow the exclusion or limitation of incidental or consequential damages or limitations on how long an implied warranty lasts, so the above limitations or exclusions may not apply to you. This warranty gives you specific legal rights, and you may also have other rights that vary from state to state, or province to province.

**Service:** Units under warranty and in need of repair should be returned, shipping prepaid, to BRK Brands, Inc., Attn.: Consumer Affairs, 3920 Enterprise Court, Aurora, IL 60504-8132.

**Warranty:** BRK Brands, Inc. makes no warranty, express or implied, written or oral, including that of merchantability or fitness for any particular purpose, with respect to the battery.