

Product Manual



ICC2-ATSC4

HDTV Tuner/Controller
September 27, 2015

S12 Control Version 5.6
HD Processor Version 6.04



Table of Contents

Overview	3
Specifications	4
Physical.....	4
Front Panel.....	4
Rear Panel.....	4
Tuning	5
Includes.....	5
Options	5
Trademarks	5
Troubleshooting.....	6
RF Wiring Options.....	8
Setup Guide.....	9
IR Remote Operation.....	9
Front Panel Setup	10
On-Screen Menus (IC Mode)	11
RS-232 Control Codes.....	12
Input Selects	12
Input Command.....	12
On-Screen Menus (HD2 Mode)	14
Main Menu	14
Channel Menus	14
Caption Menus.....	16
V-Chip Settings Menus.....	16
Setup Menus	17
Pop-Up Menus	18
IC-Net Control Protocol	20
Overview.....	20
Command String Structure.....	20
IC-Net Commands.....	21
Control.....	21
Tuning	22
Tuning	23
Text.....	23
HD2-RC Remote Emulation	24
Rack Mounting	26
iC-Net Zones, Units and Device Addresses.....	27
System Map.....	28
Safety Instructions	29
Limited Warranty	30

Overview

The ICC2-ATSC 4 HDTV Tuner includes all the proven performance of the previous ICC2-ATSC+, plus added features from the 232-ATSC 4 tuner.

- Receives MPEG4 and MPEG2 programs
- Outputs up to 1080p video

The ICC2-ATSC 4 HDTV Tuner is an integrated HDTV tuner/controller that networks HD display monitors and projectors in a Display Express control system. As a universal TV tuner, the ICC2-ATSC 4 can receive ATSC, NTSC, and clear QAM cable channels from an MATV antenna or CATV cable RF system.

The tuner displays broadcasts through simultaneous HDMI and NTSC composite ports and switched HD RGBHV or Component outputs. Full-time audio is available from digital Dolby 5.1/PCM/Variable PCM HDMI, optical, and coax ports, as well as variable-level analog stereo audio outputs.

- **Integrated Display Control** - Employs RS-232 control port for integrated display or video projector control, includes onboard database of display control command
- **Through-the-RF Coax Networking** - Communicates with Display Express Web software, and custom control systems via iC-Net RF protocol
- **Universal Tuning** - Handles a mix of ATSC, clear QAM (MPEG and MPEG4) and NTSC channels, cable or off-air tuning
- **Pro Integration** - Features 2-way RS-232 control and feedback with simple ASCII commands, as well as discrete IR and wired IR - AMX and Crestron modules available
- **Fast Tuning** - Changes analog and digital channels instantly with improved RF reception
- **Total Video** - Simultaneous HDMI and composite video, switchable RGBHV or Component HD video
- **Total Audio** - Simultaneous digital Dolby 5.1/PCM/Variable PCM HDMI, coax, and optical outputs, as well as variable-level analog stereo
- **HD Scaling** - Upscales HD output up to 1080p
- **Easy Set-up** - Front-panel programming supported by LCD display, on-screen menus using HD2-RC IR remote (included), and RS-232 control commands
- **Closed Captioning** - Displays analog and digital captioning text
- **On-Screen Menus** - Setup, Electronic Program Guide, Channel, Favorites, and Program Information menus
- **Compact Rack Mounting** - Mounts in 2RU single RK1-HD or dual RK2-HD 19" rack kits
- **Includes** - 12 VDC switching power supply
- **Options** - HD2-RC wireless remote, RK1-HD and RK2-HD rack kits, CC-232 or CC-COM RS-232 control cables, IR-RXC External IR Receiver
- **Green Machine** - Meets RoHS safety and California energy standards
- **Field Updatable** - download new control and HD processor firmware from CR website

Specifications

Physical

Size (HWD): 8.5" [216mm] wide x 2.0" [51mm] height (1.5 RU) x 8.0" [203mm] deep

Weight: 1.94 lbs [890 g]

Enclosure: Steel with black powder coat paint

Mounting: 2/1.5RU Rack mounting for one or two units side-by-side optional (RK1/2-HD+, RK1S/RK2S-HD+)

Front Panel

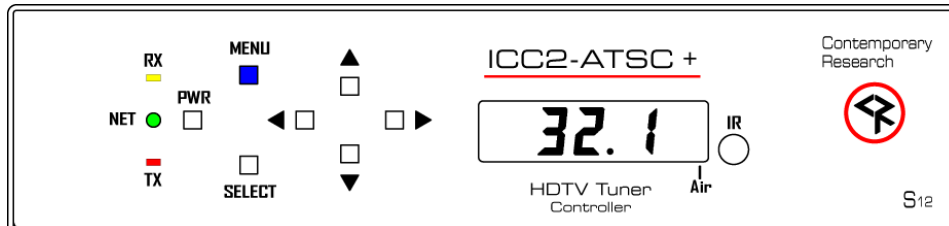

Display: Red LED Channel Display, dot separated major and minor channel numbers, dot at end indicates Off-Air tuning

IR: IR sensor

Control: Power, Menu, and Select buttons, navigation using Up and Down (Channel Up and Down) buttons Left and Right (Volume Down and Up) buttons

LEDs: RS-232 RX (Yellow), RS-232 TX (Red), Net (Green – flashes every second to confirm iC-Net control signal)

Rear Panel

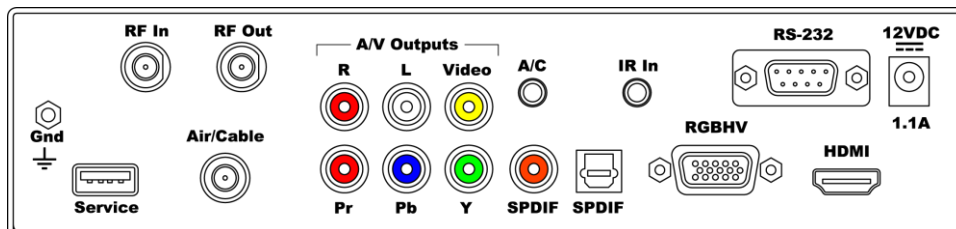

Service: USB port (not active presently)

RF In: Air/Cable, 'F', female, 75 ohm impedance, -10 to 15 dBmV typical, receives RF control channel

RF Out: 'F', female, Passes RF channels to Air/Cable input, cable included

Air/Cable: 'F', female, 75 ohm impedance, -10 to 15 dBmV typical

A/C Jack: 3.5mm jack for RF-AB Air/Cable Switch

Video Output: Simultaneous HDM and NTSC video, switch between RGB and Component

Video Out: RCA composite video output, 1V p-p at 75 ohm impedance, 480i

Component Out: 3 RCA Y, Pr, Pb outputs (1080p/1080i/720p/480p/480i)

RGB Out: RGBHV DB-15 female (1080p/1080i/720p/480p, 59.95 Hz)

HDMI: HDMI receptacle, Type A, HD video and digital audio, version 1.3 (1080p/1080i/720p/480p)

Use PCM mode if HDMI audio connection is used to most displays (not all have Dolby)

Audio Output: Simultaneous HDMI, Coax, Optical, and Stereo

Digital Audio SPDIF: Coax and Toslink optical output, Dolby 5.1 AC3/PCM/Variable PCM

Analog Audio Out: Stereo RCA audio, Mono, Stereo, or SAP, variable level

RS-232 Control: DB-9 male, RS-232 data link to control system or PC, up to 9 tuners, 300-19,200 baud

IR In: 3.5mm stereo jack for optional IR-RXC IR Receiver

Sleeve= DC power+ from power jack input, limited to less than 100mA

Ring=DC power- (GND)

Tip= IR data signal

Power In: 2.1mm coaxial jack (inside center conductor positive)

1.1 A maximum, 11.5 to 15 VDC, 12 VDC typical

Tuning

Frequency Range: ATSC and Clear QAM (cable) television 55.25 to 801.25 MHz

TV System: ATSC, NTSC, Cable, and Clear QAM (1080i/720p/480p/480i)

Tuning: Off-air 14-69 (NTSC and 8-VSB) and CATV 1-135 (Analog, 64QAM, 256QAM, 8-VSB)

Aspect Ratio: 4:3, 16:9 (Digital), 4:3, 16:9, Zoom (Analog channels)

Captioning: DTV and analog, set by program or customized for size, font and display attributes

Captioning Data: HDMI, RGB, and Component ports don't have the ability to carry captioning data.

The composite video port will carry Line 21 data, but only when tuned to an analog channel

Lock: Parental option for channels and/or rating

Includes

Compact Power Supply, 1.5A maximum, 12 VDC

RF Loop Cable for connection of RF Out to Air/Cable input

Options

RK1-HD+ Single Rack Kit, 2RU

RK2-HD+ Dual Rack Kit, 2RU

RK1S-HD+ Single Space-Saver Rack, 1.5RU (reverse mount to stack)

RK2S-HD+ Dual Space-Saver Rack, 1.5RU (reverse mount to stack)

PMT-2+ Pole Mount Bracket

RF-AB RF A-B Switch, self-terminating, closure controlled (if system has dual Air and Cable feeds)

IR-RXC External IR Receiver

CC-COM or CC-232 RS-232 Control Cable

Firmware

HD V3.05 Provides Line captioning data on Composite video from analog and digital channels, tuner stays on sub-channel with program data is lost, does not change to default N.1 channel.

SF V5.1 This adapts commands to operate with a new series tuner board.

Trademarks

- VGA and XGA are trademarks of International Business Machines
- SVGA is a trademark of the Video Electronics Standard Association
- HDMI, the HDMI logo and High-Definition Multimedia Interface are trademarks or registered trademarks of HDMI Licensing LLC.



Manufactured under license from Dolby Laboratories, Dolby and the double-D symbol are trademarks of Laboratories

Troubleshooting

TUNING CABLE CHANNELS

Tip: The 232-ATSC+ will skip encrypted channels automatically when you activate a channel scan

Tip: You can skip scanning analog channels by pressing **Select** after you start the scan.

Symptom: Channel ID is in XX-XX form, not cable box Guide form

- Cable boxes translate the actual channel #s into a virtual Channel Guide, using channels 2 – 900, or more.
- The actual (physical) channels have IDs in XXX-XX form, just like off-air channels. Non-cable HDTV tuners like the ATSC or LCD TVs don't provide Guide features, so the channels will be displayed in their native, physical major-minor channel form.
- Some cable franchisees have a listing by physical channel, many do not. You can press the INFO button on the HD2-RC remote to view the channel name.

POWER/VIDEO OUTPUT

Symptom: Tuner appears to be on, channel display is lit, but unresponsive, no video/audio out

- This often occurs when a 232-ATSC+ is used to replace an old 232-series analog tuner.
- The solution is to not use the old 500 Ma power supply, and use the 1.5 Amp power supply that comes with the ATSC. The old supply has enough juice to light up the front panel LEDs, but nothing else.

Symptom: No video on Component Out

- The RGB and Component outputs are switchable, and the tuner ships set to RGB. Use Front Panel Mode, next section to switch the HD analog video to Component.

HDMI

Symptom: No Video or Signal

- Most monitors accept HDMI in the RGB and Component color space, but there are exceptions. Try switching from RGB to Component (Front panel mode 48).
- Switch between 720p and 1080i, or down to 480P or 480i for old DVI sets. (Front panel mode 49)
- If you're connecting via a Cat5 interface, HDMI receiver, or switcher, some delay the HDCP signal slightly out of range. Call CR Support on how to extend the delay on HDMI.

Symptom: No audio or fluttering sound in display speakers connected via HDMI

Change ATSC digital audio to PCM or PCM variable (most displays do not use Dolby 5.1)

RGB/Component

Symptom: No RGB or Component Video output

Check the RGB or Component output setting in Front Panel mode 48 (48.0 is RGB, 48.2 is Component).

Symptom: No output display on VGA input

Some monitors or projectors do not support 1080i or 720P operation on the RGB port. Set resolution in Front Panel mode 49 (49.2 for 480P).

Composite Video

Symptom: Composite video out has small image in 16:9 setting, analog channels

- For a 4:3 set, tune to an analog channel and press RATIO on the remote to set to 16:9. Image will fill left to right, you'll always have a black band top and bottom.
- Set to 4:3 if you're only feeding video to 4:3 TVs.
- Set output ratio on a digital channel as well - this a different setting than for analog channels.
- If the tuner is used for 16:9 displays and analog TVs, choose the best setting for the widescreen, and the NTSC will have to be a compromise. Most of the time, setting the RATIO while tuned to an analog channel and again for a digital channel will provide the best result.

IR Control

Symptom: IR remote won't control tuner

Hold down IR remote **Select**, press **9**, and release both. Front-panel setting should be **15.9**. In addition, check if the remote works when the lights are off. Some energy-saving fluorescent lights produce interference at our IR frequency (57 Hz). Try to cover the IR sensor so the lights don't affect operation, or add the IR-RXC External IR Sensor. It's easier to hide and tilt the sensor to help with reception, and you can try Select and 4 to use the lower IR frequency (the RXC has both types of sensors).

Line 21 (analog) Captioning on Video Output

Symptom: Video out does not include captioning

The 232-ATSC+ does not carry forward closed captioning codes when tuned to an analog channel. However, all captioning from digital TV channels is converted to analog captioning on the video output.

RF Wiring Options

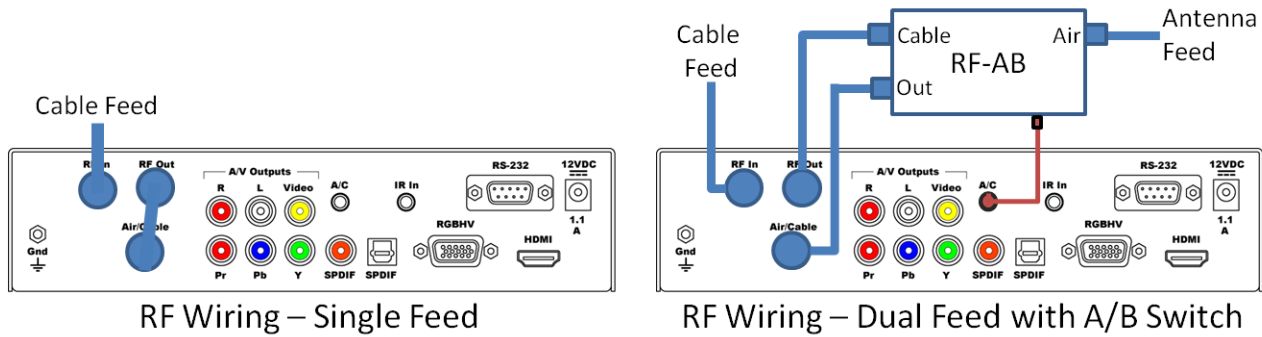

There are two ways to wire RF feeds to the ICC2-ATSC+.

Single RF Feed

Most applications will use a single RF feed, either Cable or Air (Antenna).

- Connect the RF feed to RF In on the top of the tuner. This allows the tuner to receive the iC-Net control signal.
- Connect the included short RF cable from RF Out to the Air/Cable RF input. A low-loss tap feeds the RF feed the ATSC+ tuner.

Dual RF Feed

Other applications will use both Cable and Air (Antenna) feeds. The ICC2-ATSC 4 can switch between both, maintaining separate channels lists for each. You'll need the optional RF-AB switch, which has a mini 3.5mm cable that connects to the A/C control output on the back of the tuner. The placement of RF connections on the RF-AB is different than shown – the RF ports above are arranged for clarity.

- Wire the Cable feed to the RF input of the ATSC+. Note that the Cable feed needs to go through the RF In on the ATSC+ first, so the tuner can receive the iC-Net control channel.
- Connect the ATSC+ RF Out to the Cable input of the RF-AB.
- Connect the Air/Antenna feed to the Air input of the RF-AB.
- Connect the included short RF cable to the RF-AB switch RF Out, then to the Air/Cable RF input on the ATSC+.
- Connect the 3.5mm mini plug to the ATSC+ A/C control output.

Setup Guide

The ICC2-ATSC 4 supports a mix of setup tools, including:

- HD2-RC Remote Mode (accesses On-Screen Graphic Menus and special HD functions)
- IC-RC Remote Mode (accesses Text Menus and special media functions)
- Front-Panel Setup
- IC-Net commands from system or iC Send

The reason for the options is that the ICC2-ATSC 4 is designed to offer advanced analog/digital tuning, yet be compatible with existing iC-Net systems.

IR Remote Operation

The IC-RC Remote is used with analog tuners as well as media and text menu control functions when used in iC-Net control systems. The HD2-RC IR Remote is designed for control and setup of ATSC-series HDTV tuners. Both remotes send the same IR codes, the difference is in how the tuner responds.

In most cases, IC-Net systems, especially for schools and other applications that access on-screen text menus and interactive media control, will continue to use the traditional IC-RC remote and mode.

System integrators can switch the ICC2-ATSC 4 to the HD2-RC mode to access HD features, such as channel scans and set up of 16:9 or 4:3 display modes. Then switch to IC mode to test iC-net operation and IC-Net device number.

Front-Panel Setup

The Front Panel modes are useful for setting tune mode, HD output and resolution, and switching between IC and HD2 remote modes.

IC Send Control

You'll find the free IC Send program to be a great tool for system setup and testing, especially if the site is using the ICE-HE Head End and your laptop is configured for the site's network. You can also use a PC or laptop via RS-232 with the ICC-HE Head End. Key functions include:

- **On, Off and Tune** commands to test operation to one or all ICC2-ATSC 4 units.
- **IR Mode.** Switch all tuners to IC or HD2 modes.
- **Channel Setup.** Use the T^ Command to force all units to scan channels, then use the XA and XD commands to add and remove channels from the list. If you're using RS-232 control at the head end, have an ICC2-ATSC 4 at that location to check your setup.
- **Tuner Setup.** Use LM and TM commands to configure general tuner operation.
- **Default Input.** Use the ER command to set the default input.

Device Address Settings

Use the front-panel setting 2 and 3 to set the address. Menu 3 sets the Zone address, and Menu 2 sets the individual number in the zone. For example the system address for a controller is 257, set Menu 2 to 2.1 (1), and Menu 3 to 3.1 (Zone 1, which is address 256), $1 + 256 = 257$ system address. The controller will act by itself when you send the unique 257 code, as a zone group when you send 256, or with all with address 4095.

Zone	1	2	3	4	5	6	7	8
	256	512	768	1024	1280	1536	1792	2048
Zone	9	10	11	12	13	14	15	
	2304	2560	2816	3072	3328	3584	3840	

Front Panel Setup

To Enter a Front Panel Programming Mode:

1. Press **and hold** the Power button, then press the Volume Up button
2. Release all buttons, the ICC2-ATSC 4 will now be in the front-panel programming mode. The Air LED will flash, indicating programming mode.
3. The first two digits show the mode, the second show the option.
4. Changes are saved in non-volatile memory as they are entered.
5. The Volume up/down buttons scroll through programming modes, forward and reverse.
6. The Channel up/down buttons scroll through possible options for each mode.

To Exit the Front Panel Mode

Push and release the Power button.

Mode	0-9	Parameters
RF Tune	0.0	0=CATV (Default) 1=Off-Air 2=IRC 3=HRC 4=Cable Auto
Baud Rate	1.1 1.2 1.3 1.4 1.5 1.6 1.7	300 600 1200 2400 4800 9600 19200
Unit Number	2.1	1-99 (The LCD can't show a higher number. It's easier to use the Menu 999 function on the next page. Set IR Mode 18.1 to 18.0 to see the onscreen character generator. Once you're at the device # menu, you can enter the unit's address using the number keys on the IR remote.)
Zone Number	3.0	1-15 System device number is (Unit + (Zone * 256))
Panel Lockout	4.0	Reserved (performed by LM command)
Power-up Volume	5.0 5.X	Restore previous level (default) 1 – 63 sets volume level
Firmware Version	6.20	Ex: Version 2.0 - Press and hold Channel Up, then Power to restore tuner to default settings Press and hold Channel Up and Down, then Power to scan channels
Captions	10.0 10.1	Captioning off (default) Captioning on
Caption Mode	11.1 11.2 11.3 11.4 11.X	1=Caption 1 (default) 2=Caption 2 3=Caption 3 4=Caption 4 5-8= Text 1-4 (rarely used)
Video Detect	12.3	No AV mute (fixed)
AV Status	13.0	No AV status (default)
Label Mode	14.2	Numeric (fixed)
IR Receive	15.9	0= Off, 9=Receive IR
Digital Captions	17.1	1-6, Default is 1
IR Remote	18.1	0=IC-RC 1=HD2-RC
Tune Control	19.0	0=Tune all channels 1= Only tune channels in List
Digital Audio	47.0 47.1 47.2	0=AC-3- Dolby 5.1 1=PCM (set to this for audio through HDMI) 2=PCM Variable (default)
HD Output	48.0 48.2	RGB (Default) Component
HD Format	49.0 49.1 49.2 49.3 49.4	0=1080i (Default) 1=720p 2=480p 3=480i 4=1080p

On-Screen Menus (IC Mode)

The remaining installation steps use the IR remote and the built-in character generator of the ICC2-ATSC+.

1. Change the IR Remote mode in front-panel menu 18 to **IC-RC (18.0)**. This will enable the character generator to display the menus below.
2. Touch **Menu**, then **999**, then **Enter**.
3. The text **CR MENU>** should appear on the screen.
4. Key in one of the commands shown below, then press **Enter** to activate.
5. Note that, in Menu mode, the **Channel Down** key acts as a backspace/delete key.

Command	Function
45678	Display firmware version
45679	Display the unit's device #. At this point, you can use the Channel Down key as a Delete key, enter a new device # with the remote's numeric keypad, then hit Enter to save the new number.
45700	Display current projector/monitor control commands. The code is installed by CR when the unit ships, codes can be changed over the RF. See RS-232 Control Codes on the next page.
45718	IR Remote Type 0=IC-RC 1=HD2-RC
45719	Tuning Control 0=Tune all channels 1= Only tune channels in List
45720	Set Display/Projector Input Enter code 1-19. See page 23 in the ER section for input codes
65478	Reset controller, similar to disconnecting power then restarting.
65487	Initialize to factory default settings: Power on, unlocked, display channel 11, channel ring set to 4, 5, and 11, Group 0. Note that this command works even if TV power is off or control is locked out.
65480	Enable constant Net transmit to the Head-End. This is used for measuring the signal strength of the unit's RF output. Press Enter to stop transmit or the unit will automatically stop after 50 seconds.
65481	Display DA transmitter frequency control voltage – should be 2000 - 3150.
65482	Display iCC-Net RF receive signal strength. Shows Net RX if receiving the iC-HE's "heartbeat" pulse once per second, !NET RX if not.
65483	Display DF transmitter frequency deviation – should be 245 - 300

RS-232 Control Codes

The following chart includes the current control codes for TVs and projectors. We can add new command sets as needed.

The ICC2-ATSC 4 is shipped pre-loaded with the specific RS-232 code. Units can be updated to different control code sets via the RF.

MFG	Type	Notes
Full Operation		Responds to 0-NNN TV command for inputs
LG	LCD	
Mitsubishi	VP	
NEC 2	LCD	Older M-series monitors
NEC 3	LCD	New M, P, S, V, X series
Projection Design	VP	
Library		Responds to Input command, will be upgraded to full operation when needed
Eiki	VP	
Epson	VP	
Christie	VP	
InFocus	VP	
Hitachi	VP	
NEC 1	Plasma	
Optoma	VP	
Panasonic	LCD	
Pioneer	LCD	
Samsung	LCD	
Sanyo	VP	
Sharp	VP	
Sony	VP	
Sony	LCD	
Specialty		
Extron	WP	Emulates Wall Panel buttons

Input Selects

The code sets listed in **Full Operation** above the list have the ability to select inputs from a special channel command, 0-NNN. For example, a 0-211 command would send the TV to the HDMI 1 input. For some makes, such as LG, you need to send a TV/Tuner command (0-200) to restore the TV to the current channel. For other sets, sending a channel command automatically selects the tuner if it's at a different input. The command list covers all the possibilities, not all sets have every option.

115=Captions
 200=TV/Tuner
 201=Video1
 202=Video2
 203=Video3
 204=S-Video1
 205=S-Video2

206=Component1
 207=Component2
 208=RGB1
 209=RGB2
 210=RGB3

211=HDMI1
 212=HDMI2
 213=HDMI3
 214=HDMI4
 215=HDMI5

Input Command

You will need to specify the default input for the ICC1-ATSC+, so that the unit will return to the correct input. You can use the 45700 menu command on page 11 to set the input, or use IC-Send or Display Express to send the ER command on page 23 to the tuner once it's on the IC-Net RF network.

HD2-RC IR Remote

The HD2-RC IR Remote can be used to setup the tuner and for daily operation. The IC-RC remote will work as well, the image below shows the function of the keys when the tuner is in the HD2-RC mode.

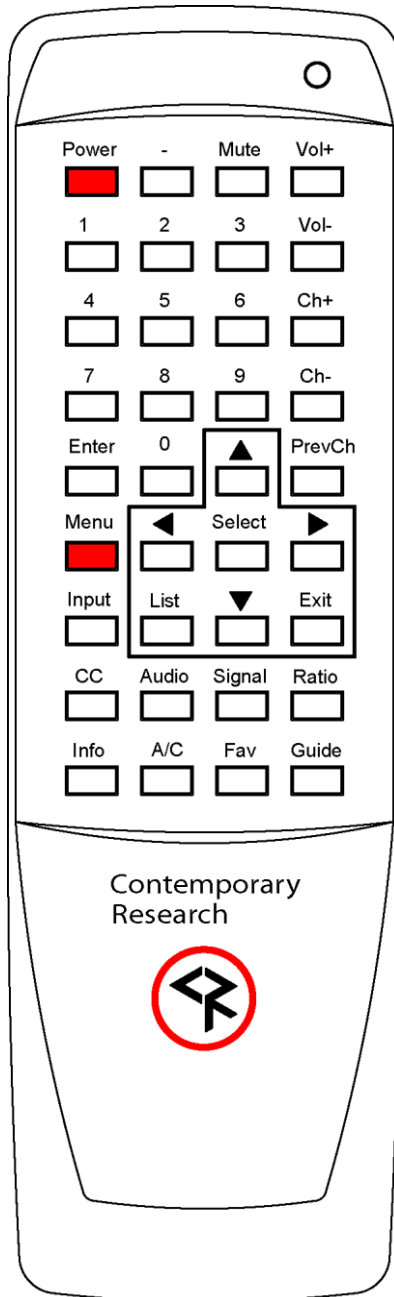

Power

Turns tuner on and off. Discrete on and off IR commands are available as well.

Volume Control

Use the **Vol+**, **Vol-** and **Mute** buttons.

Channel Selection

The key change in digital tuning is the need to add a dash (-) and number after the traditional channel number. Analog channels are accessed using XX-0, digital channels using XX-1 (or -2, -3, etc).

Ch+, **Ch-** and **PrevCh** can be used to access and recall channels.

Menu Operation

Press Menu to access the on-screen menus.



- Use the directional **Arrows**, **Select** and **Exit** to navigate the menus.
- **List** displays the list of all channels, arrow keys add/remove channels, set Favorite Channel list
- **Exit** steps backwards out of menus
- **Enter** selects menu choice

Special Functions

- **CC** steps through available closed-captioning options
- **Audio** selects audio and SAP modes
- **Signal** displays channel signal level
- **Ratio** steps through aspect ratios, options depend on channel and output types
- **Info** launches on-screen information window
- **A/C** selects Air or Cable tuning
- **Fav** Displays list of favorite channels
- **Guide** displays on-screen Guide

Features of many of the Special Function commands depend on whether the current channel is analog or digital.

On-Screen Menus (HD2 Mode)

<p>Main Menu</p> 	<p>Selects sub-menus.</p> <ul style="list-style-type: none"> • Arrow keys highlight option • Select (or Enter) chooses option • Menu steps back or exits menu • Exit exits all menus • Some options are only available if you are currently tuned to an analog or digital channel
<p>Channel Menus</p> 	<p>Sub-Menu for Channels offers options for:</p> <ul style="list-style-type: none"> • Channel Auto-Scan • Favorite Channel Selection • Add/Delete Channels • Fine Tune (If tuned to an analog channel) • Signal Strength Meter
<p>Auto-Scan</p> 	<p>Starts scan of analog and digital channels for:</p> <ul style="list-style-type: none"> • Air – looks for NTSC and ATSC channels • Cable Auto – looks for analog and digital QAM cable channels, as well as all frequency plans • Cable STD - standard cable spacing • Cable HRC – HRC cable spacing • Cable IRC – IRC cable spacing • <p>Tip: Normally, use Auto. Most cable channels will be in standard frequencies. If all the channels tune in STD but channels 5 and 6, scan for IRC. If few channels can be found, scan for HRC.</p>

Favorite Channels



Menu is also displayed from the List command, selects channels advanced by the FAV favorite channel command.

Use the Up, Down arrows to move through the list, press Select to add a channel to Favorites.

Channel Add/Delete



This menu can add or delete a channel accessed from Channel Up and Down.

You can tune to a channel you want to delete, then press Menu/Channel/Add-Delete. Press Select to delete the channel. You can also keep the page on screen as you step through channels, adding and deleting as desired. If the channel has a good signal, it will be displayed in the background.



Note that HDTV channels are broadcast on UHF frequencies. The Add/Delete will show the name of the digital channel, as well as the actual UHF channel used for broadcasting.

You can delete one of a digital channel's sub-channels without affecting the others.

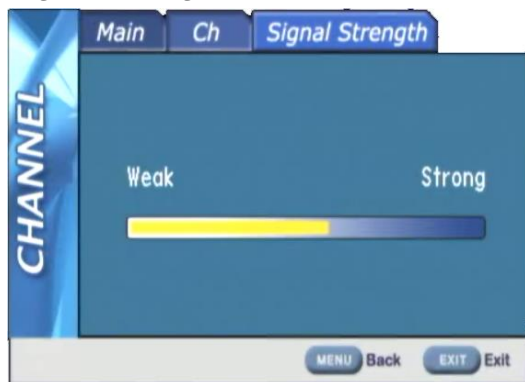
Signal Strength

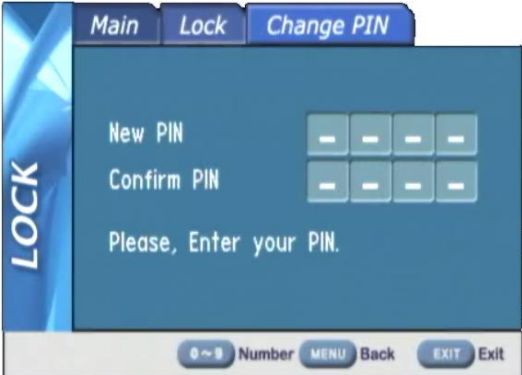

This page also displays from the Signal remote command. The graphic shows the current signal strength, and changes in real time. This allows you to monitor the strength of a channel as you adjust the antenna for best reception.

<p>Caption Menus</p> 	<p>This menu accesses captioning features:</p> <ul style="list-style-type: none"> • On/Off – turn captions on/off – <i>other options are not available if captions are off.</i> • Analog Mode - CC 1-4 and Text 1-4 • Digital Mode – Service 1-6 • Digital Font Options <ul style="list-style-type: none"> • Size – Standard (15 pixels), Large (21 pixels), or Small (11 pixels) • Style – 1-6 • Color – 8 shade of background, foreground and edge colors • Opacity – foreground and background • Edge – 6 style options <p>Version displays current version of tuner firmware</p>
<p>V-Chip Settings Menus</p> 	<p>Manages access to programming for US and Canadian standards.</p> <p>The default PIN number for access is 0000 (four zeros).</p>
<p>Change PIN</p> 	<p>Enter and confirm new PIN for access.</p>

US Rating



Use arrows and Select functions to select level of Movie and TV rating allowed.

Canada Rating







Use arrows and Select functions to select level of Movie and TV rating allowed.

Setup Menus



This series of menus select the options for tuner operation:

- **Screen Format** – 16:9 or 4:3
- **Time**
- **Sound Settings**
- **Video Noise Reduction** - On/Off (if tuned to analog)
Set to On – helps to clean up analog channels
- **Menu Language** – English, Spanish, French

<p>Screen Format</p> 	<p>Selects between 4:3 and 16:9 aspect ratios. The Ratio command can also adjust the settings.</p> <ul style="list-style-type: none"> • 4:3 Display offers three options for 16:9 video: 16:9, 4:3 (stretched vertically), and Zoom (cropped sides) • 16:9 Display offers three options for 4:3 video: 4:3 (small centered), 16:9 (stretched horizontally), and Zoom (stretched vertically and horizontally) – or 4:3 and 16:9 if the video is 16:9
<p>Time</p> 	<p>Sets time settings for:</p> <ul style="list-style-type: none"> • Daylight Saving – Select and choose on or off Note – The DST trigger comes from the broadcast stations, and may not be in sync with the new US standards. Use On/Off or time zone to offset time • Time Zone – Select local time Zone
<p>Time Zone</p> 	<p>Use left-right cursors to select the time zone, Select enters the current zone.</p>
<p>Sound</p> 	<p>Selects a variety of options, each is only active when you are currently tuned into an analog or digital channel:</p> <ul style="list-style-type: none"> • Analog MTS – Mono, Stereo, SAP (same as Audio) • Multi-Track – English, French, Spanish • Digital Out – AC-3 (Dolby 5.1), PCM, or variable-level PCM. Set to PCM when using audio through the HDMI connection – most displays cannot decode AC-3 (Dolby 5.1). • Auto Volume – On or off
<p>Pop-Up Menus</p>	

Info



Activated from Info command.

- **Channel** – Analog or digital, Mode, Name
- **Time** – current time and date
- **Program** – Times and name (if digital)
- **Details** – Resolution, Audio Mode, Captions, Rating

Guide

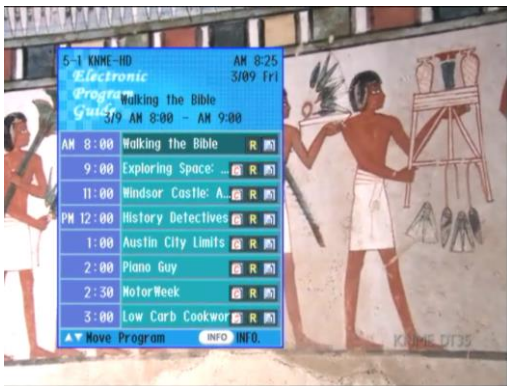

Shows the day's programming guide for current station. Use Up or Down arrows to move through Guide.

IC-Net Control Protocol

Overview

RS-232 control for up to 4000 TV Controllers is provided through an iC-series Head-End Network Controller. The ICE-HE Ethernet Head End and ICC-HE Head End manage iC-Net communication over RF Coax to ICC1 (1-way) and ICC2 (2-Way) TV Controllers.

Each TV Controller is assigned a unique device number from 1 to 4000 to which control commands are addressed. The devices are organized into 16 zones of 255 devices. All the devices in each zone will respond to a single "virtual device number" — one device number that represents all devices in each zone. There is also a global device number, 4095, that will command all devices in the system. This feature dramatically speeds up system operation and programming, because one command can affect an entire group of devices—or all. To take advantages of this feature, review the section **iC-Net SmartZones** in this manual.

In ABC-Net, we reserve the first group of devices, 1-255, for components operating on a connected control system. Zones 1-16 are used for CR TV Controllers, Video Display Controllers and Tuners. As it's unlikely any system will use all 4000 devices, this may be a good device standard for your system as well.

The Remote RS-232 port on the Head-End Network Controller can communicate from 1200 to 38.4K baud. The factory default setting is 19.2K baud, 8 data bits, No parity, and 1 stop bit.

Command String Structure

Characters in command strings are expressed in a combination of hex and ASCII characters. For clarity, the following protocol examples use the following conventions:

- Single-byte hex numbers are preceded by the '\$' symbol
- ASCII characters or strings are enclosed in single quotes
- Numbers not marked as hex or ASCII are a single decimal byte
- Parameters shown in < > brackets are single byte
- A series of multiple commands or parameters are set apart by [] brackets
- Commas separate the bytes, but are not part of the protocol
- Double quotes enclose the command string, but are not part of the protocol

Command format:

"\$A5,<dh>,<dl>,<ncb>,<cmd1>,<parameter> [<cmdN>]"

\$A5	Starts the command
<dh>	The zone or high order byte of the device*
<dl>	The unit or low order byte of the device (0 for global zone)
<ncb>	The number of command bytes to follow
<cmd1>	The first command byte
<parameter>	Command parameters (not used by all commands)
[<cmdN>]	Multiple commands can be concatenated, with byte count added to <ncb>

* *iC-Net devices are arranged with a zone mindset. For example, a command sent to Device 256, which triggers all the units in Zone 1, would be expressed as \$A5, 1, 0 (first zone, device zero). A command sent to 257 would be \$A5, 1, 1 (first zone, device 1 in the zone). See iC-Net SmartZones toward the end of this manual.*

IC-Net Commands

Command	Description	
Control		
Power Off	P0	"\$A5,<dh>,<dl>,2,'P0' " (6 bytes)
Power On	P1	"\$A5,<dh>,<dl>,2,'P1' " (6 bytes)
Power Toggle	PT	"\$A5,<dh>,<dl>,2,'PT' " (6 bytes)
Volume	VL	"\$A5,<dh>,<dl>,3,'VL',<vol level>" (7 bytes) Sets TV volume level 0 = Mute 1 - 63 = Minimum level (1) to maximum volume (63)
RS-232 Control	T0	"\$A5,<dh>,<dl>,3,'T0'<type> " (7 bytes) - Sets RS-232 control codes V 2.0 - Code is fixed by firmware
IR Remote	Q8=	"\$A5,<dh>,<dl>,3,'Q8',<IR Remote>" (7 bytes) 0=IC-RC 1=HD2-RC
Control Lock	LM	"\$A5,<dh>,<dl>,3,'LM',<control>" (7 bytes) Locks out front panel and IR remote control functions. Bit 7 Selects IR remote control operation (0=enabled, 1=disabled) Bit 6 Selects volume control operation (0=enabled, 1=disabled) Bit 5 - 1 Always 0 Bit 0 Selects front panel buttons operation (0=enabled, 1=disabled)
Operating Parameters	TM	"\$A5,<dh>,<dl>,3,'TM',<setting>" (7 bytes) Sets up key functions in the unit Bit 0 - Alpha channel labels 0=alpha labels off 1=alpha labels on Bit 1 - Numeric channel labels, 0=num labels off 1=num labels on Bit 2 - Channel up/down operation, 0=Tune Ring, 1=Send IR Keypad response Bit 3-7 = 0
Control String	UX	"\$A5,<dh>,<dl>,2+string length>,'UX'<string>" (variable bytes) Sends an RS-232 string (ASCII, decimal, or hex) directly to the TV display. Ex: "\$A5,1,2,6,'UX', 'PON', 13" Sends PON, followed by carriage return (device 258)

Command	Description	
Tuning		
Tuning Format	S0=	"\$A5,<dh>,<dl>,3,'S0',<format>" (7 bytes) 0=CATV 1=Off-Air 2=IRC 3=HRC 4=Cable Auto
Tuning Style	H1=	NA
TC Response	H2=	NA - When the ICC2-ATSC 4 receives an analog channel command, it will attempt to tune the digital equivalent first. If there is not a matching virtual channel, the unit will tune the analog channel.
Channel Up	TU	"\$A5,<dh>,<dl>,2,'TU' " (6 bytes) - Tunes to next channel up
Channel Dwn	TD	"\$A5,<dh>,<dl>,2,'TD' " (6 bytes) - Tunes to next channel down
Prev Channel	TP	"\$A5,<dh>,<dl>,2,'TP' " (6 bytes) - Tunes to previous channel
Tune Analog Channel	TC	"\$A5,<dh>,<dl>,3,'TC', <channel>" (7 bytes) - Tunes to a specific channel 2-127
Scan Mode	D0=	"\$A5,<dh>,<dl>,3,'D0',<mode>" (7 bytes) - Scan Mode Sets scan mode for digital and analog channels from the T^ or front panel scan command. 0= Scans for analog and digital channels scan (default) 1= Scans for digital only, deletes analog channels 2= Scans for digital only, keeps analog channels 3= Scans for analog only, deletes digital channels 4= Scans for analog only, keeps digital channels
Channel Scan	T^	"\$A5,<dh>,<dl>,2,'T^' " (6 bytes) - Initiates channel scan
Tune HD Channel	TH=	"\$A5,<dh>,<dl>,5,'TH',<H1>,<Major>,<Minor>" (9 bytes) The tuner will ignore the first bit (H1), and tune the major (virtual) and minor channels. Values may be in hex or decimal. Ex: "\$A5,1,4,5,'TH',0,2,3" Device 260, virtual channel 2-3 See page 12 on how to use TH to select inputs
Add Channel	XA=	"\$A5,<dh>,<dl>,5,'XA',<chan Major>,<chan Minor>,<RF physical channel>" (9 bytes) - adds channel to tune ring/list
Delete Channel	XD=	"\$A5,<dh>,<dl>,4,'XD',<chan Major>,<chan Minor>" (8 bytes) - Deletes channel from tune ring/list
Tune Control	Q9=	"\$A5,<dh>,<dl>,3,'Q9',<control>" (7 bytes) 0= Tune any channel 1= Only tune channels from the tune ring/list
Captions	Q0=	"\$A5,<dh>,<dl>,3,'Q0',<on-off>" (7 bytes) 0=Captioning off (default) 1=Captioning on
Caption Mode	Q1=	"\$A5,<dh>,<dl>,3,'Q1',<mode>" (7 bytes) 1=Caption 1 (normal setting for most captioning) 2=Caption 2 3=Caption 3 4=Caption 4 5-8= Text 1-4 (rarely used)

Command	Description																					
Tuning																						
Input	EI	"\$A5,<dh>,<dl>,3,'EI',<Input>" (7 bytes) Sets the input for controlled projector or display. See Input list in ER.																				
Input Ring	ER	"\$A5,<dh>,<dl>,<ncb>,'ER', [<input 1>, <input N>]" (variable bytes) Sets a list of inputs that are cycled by the Input command on the IC-IR remote or KK command. Follow the standard list of inputs below, check with CR Support on which are available for your make and model of video display. <table border="0"> <tr><td>1 Video1</td><td>11 DVI/HDMI1</td></tr> <tr><td>2 Video2</td><td>12 DVI/HDMI2</td></tr> <tr><td>3 Video3</td><td>13 DVI/HDMI3</td></tr> <tr><td>4 S-Video1</td><td>14 DVI/HDMI4</td></tr> <tr><td>5 S-Video2</td><td>15 DVI/HDMI5</td></tr> <tr><td>6 Component1</td><td>16 TV</td></tr> <tr><td>7 Component2</td><td>17 TV2</td></tr> <tr><td>8 RGB1</td><td>18 1394</td></tr> <tr><td>9 RGB2</td><td>19 Memory stick</td></tr> <tr><td>10 RGB3/DTV</td><td></td></tr> </table> Ex: "\$A5,<dh>,<dl>,6,'ER', 1,4,8,11" sets ring to Inputs 1, 4, 8 and 11.	1 Video1	11 DVI/HDMI1	2 Video2	12 DVI/HDMI2	3 Video3	13 DVI/HDMI3	4 S-Video1	14 DVI/HDMI4	5 S-Video2	15 DVI/HDMI5	6 Component1	16 TV	7 Component2	17 TV2	8 RGB1	18 1394	9 RGB2	19 Memory stick	10 RGB3/DTV	
1 Video1	11 DVI/HDMI1																					
2 Video2	12 DVI/HDMI2																					
3 Video3	13 DVI/HDMI3																					
4 S-Video1	14 DVI/HDMI4																					
5 S-Video2	15 DVI/HDMI5																					
6 Component1	16 TV																					
7 Component2	17 TV2																					
8 RGB1	18 1394																					
9 RGB2	19 Memory stick																					
10 RGB3/DTV																						
Text																						
Write Text	DM	"\$A5,<dh>,<dl>,<ncb>,'DM', <start line>,<text color>,<text background color>,<screen background>,<size and shadow>,<timeout>,<message bytes>" (variable bytes) Clears current text, displays text message over video (default) or blank background. The built-in character generator can accept up to 40 characters of text (including carriage returns), 28 characters per line. Use a hex \$0D or decimal 13 in the text as a carriage return, which will advance CG to the next line, first space on the right. Start Line - 1-9 Text Color - 1-7= White Text Background Color - 0-7=Transparent (no background) Full screen background - 0=normal insert over video Size and Shadow - 0-3=small text with drop shadow Time-Out - 0=15-second display, 1=persistent Persistent text stays on screen until the next DM, or new Menu or channel. Ex1: "\$A5,<dh>,<dl>,10,'DM', 2,7,0,0,1,0,'TEST' " displays the word TEST on the second line, white text, inserted over video, small size with drop shadow, and timing out after 15 seconds. Ex2: "\$A5,<dh>,<dl>,2,'DM' " clears on-screen display, also clears persistent text The ATSC uses white text and clear backgrounds when it receives a Text or Background Color parameter between 1 and 7, and accepts values 0-3 for text size and shadow. This allows compatibility with Smart TVs mixed in the same system that can display other colors and fonts.																				
Return	EB	"\$A5,<dh>,<dl>,2,'EB' " (6 bytes) Moves cursor down to the first column of the next row.																				
Text Timeout	DQ	"\$A5,<dh>,<dl>,3,'DQ', <time>" (7 bytes) Sets screen timeout to specified time in seconds (1-254). If time is 0 or 255, any text on the screen will persist indefinitely, or until cleared.																				

HD2-RC Remote Emulation

You can also emulate IR commands sent from the CR HD2-RC Wireless Remote. If you are using the numeric keys to select a channel, the user or program will need to follow the numeric command with an Enter.

KK=<key>	"\$A5,<dh>,<dl>,3,'KK',<control>" (7 bytes)	
	* = Reserved for future products/applications	
0=*		88=Favorite
1=*		95=List
2=*		96=Add/Delete Channel
3=*		98=Air/Cable
4=*		99=Dash -
5=*		100=Info
6=*		101=Prev Chan
7=*		105=Menu
8=*		106=Cur Rt
9=Power (tog)		107=Cur Lt
10=0		108=Cur Up
11=1		109=Cur Dn
12=2		110=Select
13=3		111=Exit
14=4		115=CC
15=5		141=Format 1080i
16=6		142=Format 720p
17=7		143=Format 480p
18=8		144=Format 480i
19=9		145=Format 1080p
20=		149=Output RGB
21=Enter		151=Output YPbPr
22=Ch Up		153=Air
23=Ch Dn		154=Cable
24=Vol Up		155=Aspect ratio pillar/letter box
25=Vol Dn		156=Aspect ratio full/wide
26=Vol Mute (tog)		157=Aspect ratio zoom
27=Power On		158=AC-3(Dolby 5.1)
28=Power Off		159=PCM
29=Menu		160=PCM Variable
63=Guide		161=16:9
80=Freeze		162=4:3
81=Signal		
82=Ratio		
85=Audio		

IC-Net Response

Response	Description															
New Channel	T	<p>"`<,<dh>,<dl>,2,'T',<new channel>" (6 bytes)</p> <p>Sent in response to T? command.</p>														
IR Function	R	<p>"`<,<dh>,<dl>,2,'F',<IR Function>" (6 bytes)</p> <p>Sent when unit receives a new function command is pressed (1-8) or released (0) from the IR remote.</p> <p>0 = Release 1 = Play 2 = Stop 3 = Pause 4 = Fast Forward 5 = Rewind 8 = Record</p>														
IR Key	K	<p>"`<,<dh>,<dl>,2,'K',<IR Key>" (6 bytes)</p> <p>Sent when unit receives a new key command is pressed (10-23) or released (0) from the IR remote.</p> <table border="0"> <tr> <td>0 = Release</td> <td>102 = Timer</td> </tr> <tr> <td>10 - 19 = Numeric keypad entry 0 - 9</td> <td>105 = Media Menu</td> </tr> <tr> <td>21 = Enter</td> <td>106 = Cursor Right</td> </tr> <tr> <td>22 = Channel Up</td> <td>107 = Cursor Left</td> </tr> <tr> <td>23 = Channel Down</td> <td>108 = Cursor Up</td> </tr> <tr> <td>29 = Menu</td> <td>109 = Cursor Down</td> </tr> <tr> <td>101 = Previous Channel</td> <td>110 = Media Select</td> </tr> </table> <p>The 0 - 9, Channel Up/Down functions are sent only if enabled in the TM command (Bit 2 = 1). The Channel Up/Down responses will be sent if the Tune Ring contains no channels - see Ex2 in the Tune Ring command section.</p>	0 = Release	102 = Timer	10 - 19 = Numeric keypad entry 0 - 9	105 = Media Menu	21 = Enter	106 = Cursor Right	22 = Channel Up	107 = Cursor Left	23 = Channel Down	108 = Cursor Up	29 = Menu	109 = Cursor Down	101 = Previous Channel	110 = Media Select
0 = Release	102 = Timer															
10 - 19 = Numeric keypad entry 0 - 9	105 = Media Menu															
21 = Enter	106 = Cursor Right															
22 = Channel Up	107 = Cursor Left															
23 = Channel Down	108 = Cursor Up															
29 = Menu	109 = Cursor Down															
101 = Previous Channel	110 = Media Select															
IR Menu	M	<p>"`<,<dh>,<dl>,5,'M',<msh>, <msl>, <mph>, <mpl>" (9 bytes)</p> <p>Sent when unit receives a new Menu command is pressed or released (0) from the IR remote. Menu Selection high and low bytes are in <msh> and <msl>. Menu Parameter high and low bytes are in <mph> and <mpl>.</p> <p>A Menu command is initiated by pressing the Menu key, followed by a numeric entry, then the Enter or Channel Up key. During the Menu process, the Channel Down key acts as a backspace or delete key.</p> <p>Some selections that need only a single numeric entry and will have a parameter value of zero (0). Those keys are 0, 8, 9, 18, 20, 30, 900, 911, and 912.</p> <p>Menu selections that will prompt the user to enter a second parameter entry are:</p> <p>1 = Select Media 2 = Password 3 = Chapter Search 4 = Frame Search 11 = Channel 21 = Page Zone 22 = Page Room 25 = Go 21 = Attach Zone 32 = Attach Room</p> <p>Tip: The Menu entries are active even if the TV power is off.</p>														

Rack Mounting

Three options are available for rack-mounting tuners.

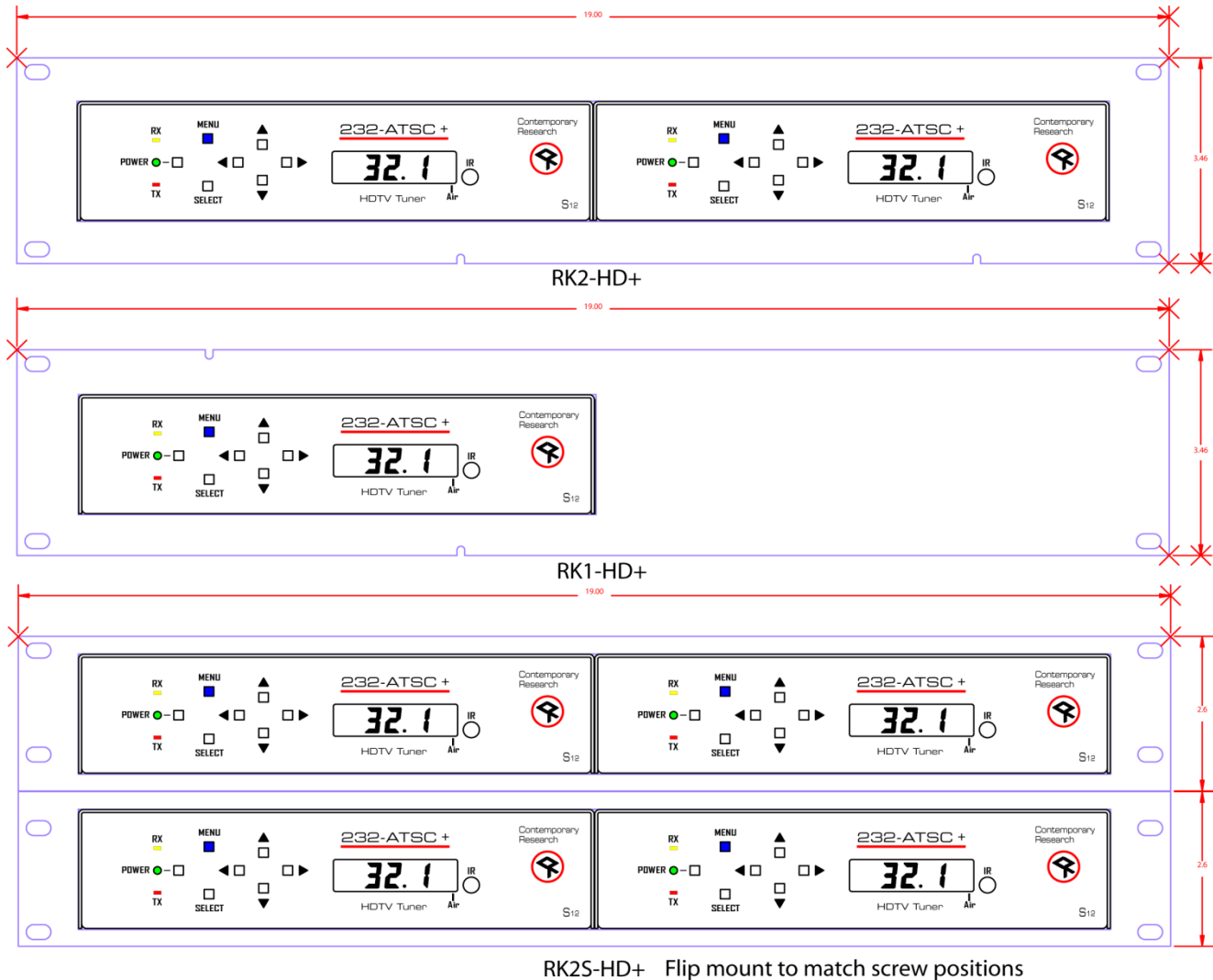

RK1-HD+

- Insert 232-ATSC+ into RK1-HD frame.
- Use screws included with kit to attach tuner to the side flanges.

RK2-HD+

- Use supplied screws to attach left tuner to left and top flanges
- Use supplied screws to attach right tuner to right and top flanges

RK2S-HD+ Space-Saver Rack Kit

- Use supplied screws to attach left tuner to left and top flanges
- Use supplied screws to attach right tuner to right and top flanges
- Mount the first rack, then flip the next rack kit upside down, add tuners and mount
- With this method, you can mount 4 tuners in 3 rack spaces

iC-Net Zones, Units and Device Addresses

In the front-panel setup instructions, you set the Unit # (1-255), then the Zone # (1-15). This refers to the iC-Net address structure that includes device number 256 – 4095 that is divided up into 15 Zones.

To simplify controlling groups of devices, iC-Net is divided into 15 zones of 255 devices, called SmartZones. All the devices within each zone can be controlled simultaneously by sending a command to a single virtual device number.

For example, noting the zone chart below, if we send a Power On command to device #256, all iC-Net controllers in Zone 1 will turn off at the same time.

This is an immensely powerful feature, because most systems can only address one device at time. If you need to turn off all 50 TV in a zone, you would need to send 50 commands. In addition to the hassles of creating multiple commands, there would be a long delay between the first and last command. One command, instant response is easier.

The Zone number plus the Unit number equals the actual device address.

Zone	Device #	Unit	Total Device #
1	256	1-255	257-511
2	512	1-255	512-767
3	768	1-255	769-1023
4	1024	1-255	1025-1279
5	1280	1-255	1281-1535
6	1536	1-255	1537-1791
7	1792	1-255	1793-2047
8	2048	1-255	2049-2303
9	2304	1-255	2305-2559
10	2560	1-255	2561-2815
11	2816	1-255	2817-3071
12	3072	1-255	3073-3327
13	3328	1-255	3329-3583
14	3584	1-255	3585-3839
15	3840	1-255	3841-4000
All Zones	4095		

Tip: While many applications can use just the Zone number, it's a good practice to assign a unique Unit number to each controller in the zone. This allows the system software to address individual controllers if necessary.

System Map

One of the key tasks for iC-Net integrators is to create a logical **System Map**, assigning device numbers to TV controllers so they fall into physical zones useful to the client. The device mapping could be sorted by type or location; whichever suits the application.

iC-Net Zone	Zone	Room	Unit	Device
1	W 1 st Floor			256
		W151	1	257
		W152	2	258
		W153	3	259
		W154	4	260
2	W 2 nd Floor			512
		W251	1	513
		W252	2	514
		W253	3	515
		W254	4	516
3	E 1 st Floor			768
		E151	1	769
		E152	2	770
		E153	3	771
		E154	4	772
4	E 2 nd Floor			1024
		E251	1	1025
		E252	2	1024
		E253	3	1025
		E254	4	1026
5	Cafes			1280
		G100	1	1281
		G150	2	1282
		G151	3	1283
6	Entrance			1536
		TV 1	1	1537
		TV 2	2	1538
7	Hallways			1792
		W1	1	1793
		W2	2	1794
		E1	3	1795
		E2	4	1796
8	Concession			2048
		Lower	1	2049
		Upper	2	2050
All Zones	All			4095

Safety Instructions

Read before operating equipment.

1. **Cleaning** - Unplug this product from the wall outlet before cleaning. Do not use liquid cleaners or aerosol cleaners. Use a damp cloth for cleaning.
2. **Power Sources** - Use supplied or equivalent UL/CSA approved low voltage DC plug-in transformer.
3. **Outdoor Antenna Grounding** - If you connect an outside antenna or cable system to the product, be sure the antenna or cable system is grounded so as to provide some protection against voltage surges and built-up static charges. Section 810 of the National Electrical Code, ANSI/NFPA No. 70, provides information with respect to proper grounding of the mast and supporting structure, grounding of the lead-in wire to an antenna discharge unit, size of grounding conductors, location of antenna discharge unit, connection to grounding electrodes, and requirements for the grounding electrode.
4. **Lightning** - Avoid installation or reconfiguration of wiring during lightning activity.

Power Lines - Do not locate an outside antenna system near overhead power lines or other electric light or power circuits or where it can fall into such power lines or circuits. When installing an outside antenna system, refrain from touching such power lines or circuits, as contact with them might be fatal.

5. **Overloading** - Do not overload wall outlets and extension cords as this can result in a risk of fire or electric shock.
6. **Object and Liquid Entry** - Never push objects of any kind into this product through openings as they may touch dangerous voltage points or short out parts, resulting in a fire or electric shock. Never spill liquid of any kind on the product.
7. **Servicing** - Do not attempt to service this product yourself as opening or removing covers may expose you to dangerous voltage or other hazards. Refer all servicing to qualified service personnel.
8. **Damage Requiring Service** - Unplug this product from the wall outlet and refer servicing to qualified service personnel under the following conditions:
 - When the power supply cord or plug is damaged.
 - If liquid spills or objects fall into the product.
 - If the product is exposed to rain or water.
 - If the product does not operate normally by following the operating instructions. Adjust only those controls that are covered by the operating instructions. An improper adjustment of other controls may result in damage and will often require extensive work by a qualified technician to restore the product to its normal operation.
 - If the video product is dropped or the cabinet is damaged.
 - When the video product exhibits a distinct change in performance, this indicates a need for service.

* Note to CATV system installer: This reminder is provided to call CATV system installer's attention to Article 820-40 of the National Electrical Code (Section 54 of Canadian Electrical Code, Part I), that provides guidelines for proper grounding and, in particular, specifies that the cable ground shall be connected to the grounding system of the building as close to the point of cable entry as possible.

Limited Warranty

Contemporary Research Corporation (CR) warrants this product to be free from defects in material and workmanship under normal use for a period of two years from the date of purchase from CR. Should such a defect occur CR will repair or replace, at their option, the defective product at no cost for parts or labor.

This warranty extends to product purchased directly from CR or an Authorized CR Dealer. Consumers should inquire from selling dealer as to the nature and extent of the dealer's warranty, if any.

All warranty claims must be shipped pre-paid to the factory. Call or fax to obtain a Return Material Authorization (RMA) number.

CR is not liable for any damages caused by any of its products or for the failure of any products to perform, including any lost profits, lost savings, incidental damages, or consequential damages. CR is not responsible for any claim made by a third party or made for you by a third party. This limitation of liability applies whether damages are sought, or a claim is made, under this warranty or as a tort claim (including negligence and strict product liability), a contract claim, or any other claim. This limitation of liability cannot be waived or amended by any person. This limitation of liability will be effective even if CR or an authorized representative of CR has been advised of the possibility of any such damages.

Some states do not allow a limitation of how long an implied warranty lasts. Some states do not allow the limitation or exclusion of incidental or consequential damages for consumer products. In such states, the limitation or exclusion of the Limited Warranty may not apply to you. This Limited Warranty gives you specific legal rights. You may also have other rights that may vary from state to state. You are advised to consult applicable state laws for a full determination of your rights.

Except as expressly set forth in this Limited Warranty, CR makes no other warranties, expressed or implied, including any implied warranties of merchantability or fitness for a particular purpose. CR expressly disclaims all warranties not stated in this Limited Warranty. Any implied warranties that may be imposed by law are limited to the terms of this Limited Warranty.