

MAGICFX® POWER SHOT



PRODUCTCODE : MFX0301
VERSION : 1.0
DATE : 03.06.2012



1. CONGRATULATIONS!

You have purchased a Power Shot, a great and innovative product from MAGICFX®.

MAGIC FX is a Dutch manufacturer of professional special effects machinery and equipment. We have specialized in special effects since we established our business in 1995. All products are manufactured under the brand name MAGICFX®, which has acquired an excellent reputation for quality and reliability. All products are manufactured in accordance with the European Machinery Directive. MAGIC FX handles the entire production in-house from concept to finished product. We take care of the design, prototyping and manufacturing process.



MAGICFX® products are used by special effects professionals around the world and distributed by a dealer network across more than 80 countries.

You can rely on MAGICFX® for excellent effects!
We work hard to keep you, our customer, satisfied.

Congratulations and a lot of success and amazing shows with your new MAGICFX® Power Shot!

MAGICFX®

2. CE MARKING

	<p>NOTE: We must assume that you, your employees and others who use or come into contact with the machine are familiar with how the machine should be utilized. This specifically pertains to the proper use, maintenance and repair of the machine as described in this user manual. This also means that employees should be qualified to use machinery through training or experience. It is required that the user of this product has followed a training for the correct use of this product. Trainings are provided by MAGIC FX.</p>
	<p>DANGER WARNING: The Power Shot must only be used according to the prescriptions and instructions in this manual. Consult MAGIC FX if there are any doubts about usage.</p>

Disclaimers:

MAGIC FX B. V. specifically disclaims liability for unsafe situations, accidents and damages caused by:

- Ignoring warnings or prescriptions displayed on the Power Shot or in this documentation.
- Using the equipment for other purposes or situations than specified in this documentation.
- Modifications to the Power Shot. This includes the use of non-original spare parts.
- Improper maintenance.
- Unauthorized removal of safety covers and/or safety devices.
- Improper use of the machine.

MAGIC FX B.V. is not liable for any damages due to failures of the Power Shot.

© Copyright 2012

All rights reserved. No part of this manual may be reproduced, stored in a retrieval system or transmitted in any form or by any means, electronic, mechanical, photocopied, recorded or otherwise without the prior written permission of MAGIC FX B.V.

MAGIC FX reserves the right to make modifications at any time without having to notify the customer beforehand. The content of this manual may also be modified.

For additional information about maintenance, repair, and so on, please contact your supplier's technical department. This manual was written with the utmost care. MAGIC FX cannot be held liable for errors contained in this document or consequences thereof.

3. DECLARATION OF CONFORMITY

DECLARATION OF CONFORMITY

(according to Annex IIA of the Machinery Directive)



With respect to the Machinery Directive.
MAGIC FX B.V.
Industrieweg 16
5281 RW Boxtel
The Netherlands

Hereby declares under our sole responsibility:
We are the manufacturer of the product:

MFX0301 - MAGICFX® Power Shot

to which this declaration pertains and it is in conformity with the provisions of the following guidelines:

- Machinery Directive 2006/42/EG
- Low Voltage Directive 2006/95/EG
- EMC Directive 2004/108/EG

The following harmonized standards are applicable:

- NEN-EN-ISO 12100-1
- NEN-EN-ISO 12100-2

City: Boxtel
Date : 08-06-2010

Name: MAGIC FX

A handwritten signature in black ink, appearing to be 'B. Veroude', is written over a horizontal line. The signature is stylized and includes a large circular flourish on the left side.

Director: B. Veroude

4. FOREWORD

This manual provides pertinent information about the MAGICFX® Power Shot. The information in this manual is important with respect to the proper and safe operation of the Power Shot. If you are not familiar with the installation, operation, preventive maintenance, etc., of the Power Shot then read this manual in its entirety. MAGIC FX also urges all new users (operators, installers, maintenance staff and possibly cleaning staff) to receive training on the equipment using this manual as the basis for the training.

MAGIC FX recommends you keep the original of this manual and its attachments in a secure central location, and, keep another copy of this manual close to the workplace where the Power Shot will be used.

If you are well acquainted with the proper handling of the equipment then keep this manual handy for reference.

The following conventions are used in this manual to draw your attention to specific information or actions.





	<p>TIP: This provides you with suggestions and advice on how to perform tasks in an easier or more convenient way.</p>
	<p>NOTE: This is a note providing supplemental information that alerts you to possible problems.</p>
	<p>CAUTION: This indicates that the equipment may be damaged if procedures are not carried out in the proper manner.</p>
	<p>DANGER WARNING: This indicates that you may cause yourself injury, possibly serious, if procedures are not carried out in the proper manner.</p>

TABLE OF CONTENTS

1.	CONGRATULATIONS!	1
2.	CE MARKING.....	2
3.	DECLARATION OF CONFORMITY.....	3
4.	FOREWORD	4
5.	INTRODUCTION	6
5.1	DESCRIPTION OF THE POWER SHOT AND ITS USAGE.....	6
5.2	NECESSARY ACCESSORIES.....	6
5.3	CANNONS.....	6
6.	SAFETY	8
6.1	INTRODUCTION	8
6.2	GENERAL SAFETY RULES.....	8
6.3	WARNINGS.....	8
7.	PARTS	9
8.	ACCESSORIES.....	10
9.	PREPARATION FOR USE.....	10
10.	INSTALLING	11
11.	USAGE.....	13
12.	TURNING OFF	15
13.	TROUBLESHOOTING	16
14.	TECHNICAL SPECIFICATIONS.....	16
15.	MAINTENANCE	16
16.	GUARANTEE	16

5. INTRODUCTION

5.1 DESCRIPTION OF THE POWER SHOT AND ITS USAGE

The Power Shot is a special developed confetti and streamer shot system for electric cannons on a stage or in a truss system. The Power Shot is build to easily and safely shoot confetti and streamer cannons.

Should you use the equipment in any way other than just described then you release your supplier from all liability.

5.2 NECESSARY ACCESSORIES

The following parts are required with the Power Shot:

		
Manual	MFX0308 – POWER CABLE	Electric Cannons

Table 5.1

5.3 CANNONS

The Power Shot offers as possibility to be used with multiple electric cannons. Following table explains the possible cannons.

		
40CM ELECTRIC CANNON	80CM ELECTRIC CANNON	OTHER CONFETTI CANNONS

Table 5.2

The output of the different types is described in the following table:







TYPE CANNON	CONTENT	CANNON LENGTH	OUTPUT
	CONFETTI	40CM	5M
	STREAMERS	40CM	12M
	CONFETTI	80CM	12M
	STREAMERS	80CM	20M

Table 5.3

	<p>DANGER WARNING: Metallic products weigh more than paper product, this results in a higher output.</p>
	<p>DANGER WARNING: The electric cannons contain pressure vessels used to propel the confetti/streamers. Make sure nothing is blocking the output!</p>

6. SAFETY

6.1 INTRODUCTION

The MAGICFX[®] Power Shot is designed to shoot electric cannons remotely. These cannons are prefilled with confetti or streamers and are available in two formats 40 and 80 centimeters. The length of the cannons not only differ in the volume of content but also in the output distance.

The Power Shot should be located and used in an environment that preferably:

- Has a fairly constant temperature between 0 and 30°C.
- Has a relative humidity not exceeding a maximum of 75%.
- Is reasonably free of dust, corrosive gases, and high concentrations of organic vapors.
- Does not contain any source of vibrations in the environment.

The Power Shot is designed and constructed so that it can be used in a safe manner. Specifically, this refers to the usage, situations, and prescriptions for the device as described in this documentation. It is the responsibility of all persons authorized to use the Power Shot to read and follow the instructions in this manual.

6.2 GENERAL SAFETY RULES

- Ensure that the Power Shot is not accessible to children, unauthorized persons, or animals!
- Never shoot directly at children, persons or animals.
- Never block the output.
- Do not touch the Power Shot when it is operational or turned on. Even if the device is not in operation it might be ready to activate.
- Safety devices must not be removed or rendered inoperative.
- All required safety devices should be in good working order and functioning properly.
- Ensure that there is adequate lighting in the environment.
- Keep the workplace clean.
- Only authorized persons may work with the Power Shot.

6.3 WARNINGS

There are several warnings displayed on the Power Shot to which the following restrictions apply:

- The text must not be removed or otherwise spoiled. The operator should regularly check that the warnings are in good condition.
- The operator must ensure that the text is always visible and legible and that it remains so.



DANGER WARNING:
Any missing, damaged, or illegible text or icons must be replaced.

7. PARTS

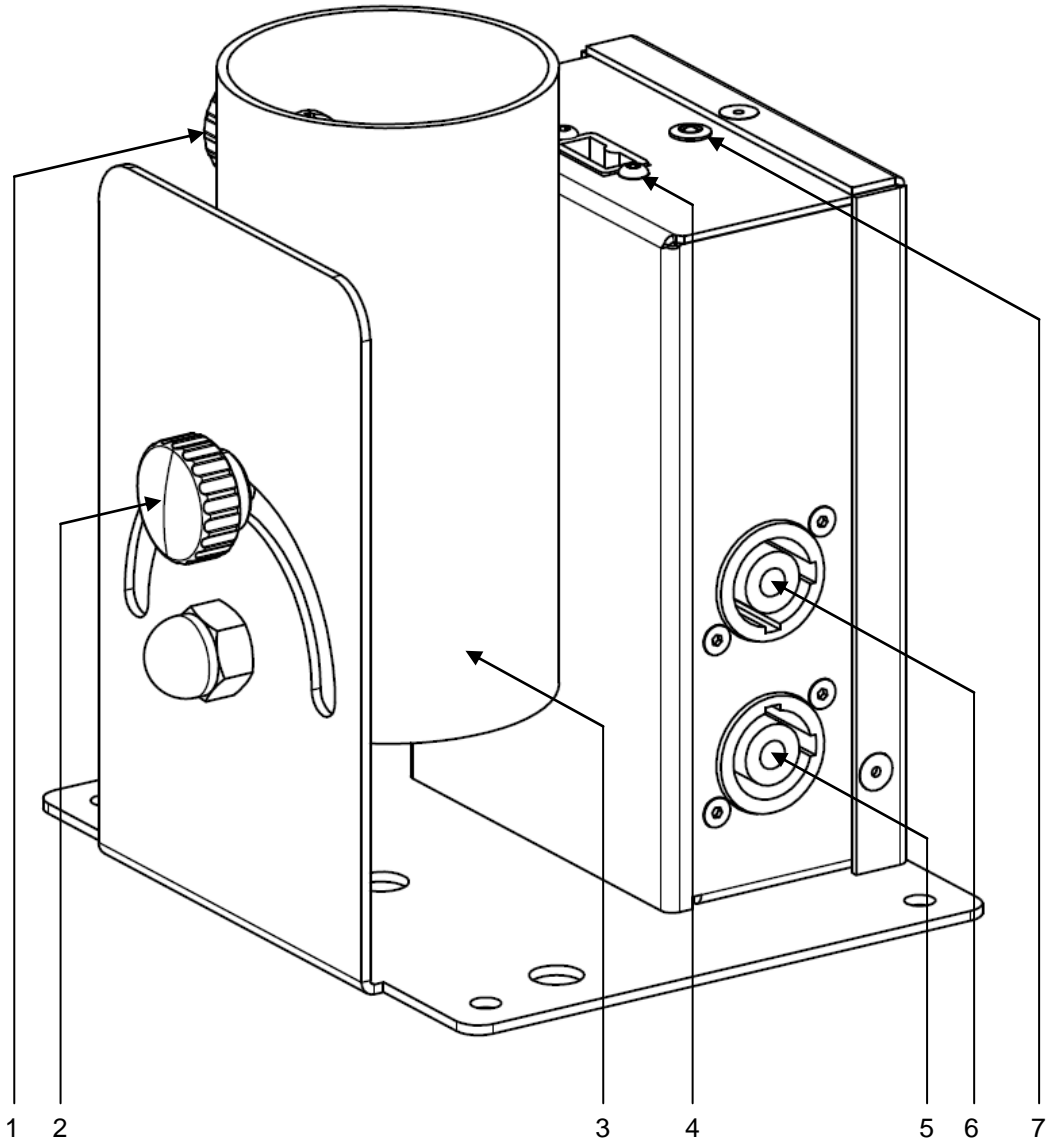

1. Cannon nut
2. Aim nut
3. Cannon holder
4. Cannon connector
5. powerCON input
6. powerCON output
7. LED indicator

8. ACCESSORIES



Table 8.1

You can order the above parts from:



MAGIC FX B.V.
Industrieweg 16
NL-5281 RW BOXTEL
The Netherlands
T. +31(0)411 63 50 13
F. +31(0)411 63 50 12
W. <http://www.magicfx.eu>
E. info@magicfx.eu



9. PREPARATION FOR USE

Unpack the Power Shot. Dispose of packaging material without causing harm to the environment. Check the device for any possible damage. You must report any damage to the device to MAGIX FX.

10. INSTALLING

	<p>CAUTION: This indicates that the equipment may be damaged if procedures are not carried out in the proper manner.</p>
	<p>DANGER WARNING: The MAGICFX® Power Shot may only be installed by authorized adults.</p>

Prepare the Power Shot for use as follows:

1a



Place the Power Shot to a flat and stable surface and lock it in place with the specially placed holes.

Continue to step 2.



Use an Base Plate for extra support. The Base Plate is designed to accommodate 1, 2 or 4 Power Shots

1b

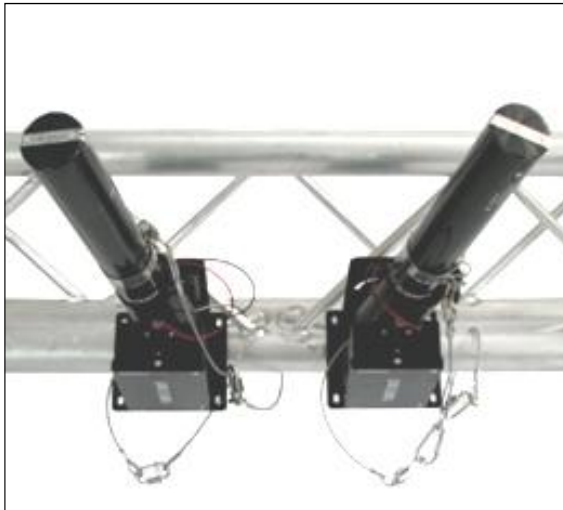

If u want to use the Power Shot in a truss construction screw on two certified truss clamps on the bottom of the Power Shot and tighten the clamp.

Continue to step 2.



Always use an safety cable to ensure the Power Shot in its place.

2.

Connect a powerCON cable to the Power Shot

Its possible to place multiple Power Shots in series by using an powerCON to powerCON cable.



3.

Check the Power Shot by connecting the other end to a power source which will light up the LED indicator. After testing disconnect the Power Shot from the power source.



Make sure there is no electric cannon connected while testing!

11. USAGE

	<p>TIP: This provides you with suggestions and advice on how to perform tasks in an easier or more convenient way.</p>
	<p>CAUTION: This indicates that the equipment may be damaged if procedures are not carried out in the proper manner.</p>
	<p>DANGER WARNING: The MAGICFX® Power Shot may only be operated by authorized adults. The Power Shot may only be operated if all parts are entire and in good working order and properly connected/installed.</p>

Operate the Power Shot as follows:

1.



Place electric cannon in the cannon holder.



In rare cases the electric cannon can be released by the Power Shot. Use an cannon clamp to secure the cannon in the Power Shot.

2.



Lock in the electric cannon by tightening the clamp on the cannon holder.



Do not tighten the clamp to hard, this can damage the electric cannon.

3.



When the electric cannon is locked in the cannon holder u can rotate the cannon holder to an desired angle. Lock it in its place by tightening the lock nut



Never aim directly at children, persons or animals.

4.



Plug in the connector from the electric cannon into the Power Shot this connector can only be inserted in one way.



Always check if the LED indicator is not lighting up before plugging in the connector.

5.



When the Power Shot is connected to a power source the electric cannon will shoot



Never shoot directly at children, persons or animals.

12. TURNING OFF

Turn off the Power Shot as follows:

1.



Make sure the Power Shot is not connected to a power source.

Remove the powerCON cable.

2.



Remove the electric cannon from the Power Shot.

13. TROUBLESHOOTING

- **The Power Shot will not turn on**

Check if the powerCON cable is connected in the right way and check if the powerCON is connected to a power source

- **The electric cannon does not shoot**

Check if the connector from the electric cannon is fully inserted, if so replace the cannon to check if the Power Shot is working.

- **The Power Shot still does not work after troubleshooting**

Always contact your dealer or the MAGIC FX technical department if you have any doubts or questions about the operation of or other issues related to the Power Shot.

14. TECHNICAL SPECIFICATIONS

Dimensions and weight	Length:	150mm (5,9")
	Width:	145mm (5,5")
	Height:	166mm (6,5")
	Weight:	1,7 (3,75lbs.) without cannon
Power	Input:	AC 230V~50-60Hz
	Output:	AC 12V~50-60Hz
	Consumption:	100W
	Fuse:	Short circuit protection

15. MAINTENANCE

To prolong the life of the Power Shot for as long as possible, you must regularly clean it and test that it functions properly.

Regardless of the reason, contact MAGIC FX if the Power Shot does not work properly

	<p>DANGER WARNING: Never replace parts yourself. Always consult MAGIC FX when needed.</p>
---	--

16. GUARANTEE

The MAGIC FX Power Shot has a 3 year factory guarantee.

- The guarantee is annulled should the Power Shot be used for purposes other than intended or for applications that are not listed in the manual.
- The guarantee is annulled should the device be used incorrectly or in a manner contrary to its instructions.
- The guarantee is annulled if the device is altered without the permission of its supplier.