

Use and Care & Installation Guide

Refrigerator

Réfrigérateur

Frigorífico



English Version	2
Version française	21
Versión en español	43



Safety Instructions	2, 3
----------------------------------	------



Operating Instructions, Tips

Automatic Icemaker	7
Icemaker Accessory Kit	7
Shelves	4, 5
Storage Drawers.....	6
Temperature Controls	3
Water Filter Accessory.....	7



Care and Cleaning

Behind Refrigerator	8
Cleaning, Outside and Inside	8
Drawer and Cover Removal.....	9
Light Bulb Replacement	9
Under Refrigerator	8



Problem Solver	19, 20
Normal Operating Sounds.....	19



Preparation

Clearances.....	10
Dimensions.....	10
Rollers and Leveling Legs.....	10
Vacation and Moving.....	10
Water Supply to Icemaker.....	10



Installation

Earthing.....	11-18
Electrical Requirements	11
Fitting a Different Plug.....	12
Great Britain and Ireland.....	12
Mains Lead Replacement	3, 12
Reversing the Door Swing	13-16
Water Line Installation	17, 18



Model and Serial Numbers	2
--------------------------------	---

Small Top-Mount No-Frost

*Sans givre à compartiment supérieur,
petit format*

Montaje superior compacto sin escarcha

Export

HELP US HELP YOU...

Read this guide carefully.

It is intended to help you operate and maintain your new refrigerator properly. Keep it handy for answers to your questions.

If you received a damaged refrigerator...

Immediately contact the dealer (or builder) that sold you the refrigerator.

Save time and money. Before you request service...

Check the Problem Solver. It lists minor operating problems that you can correct yourself.

Write down the model and serial numbers.

You'll see them on a label on the left side of the fresh food compartment.

Model Number

Serial Number

Use these model and serial numbers in any correspondence or service calls concerning your refrigerator.



IMPORTANT SAFETY INSTRUCTIONS

Read all instructions before using this appliance.



WARNING—When using this appliance, always exercise basic safety precautions, including the following:

- Use this appliance only for its intended purpose as described in this Use and Care Guide.
- This refrigerator must be properly installed in accordance with the Installation Instructions before it is used. See the grounding instructions in the Installation section.
- Never unplug your refrigerator by pulling on the power cord. Always grip plug firmly and pull straight out from the outlet.
- Repair or replace immediately all electric service cords that have become frayed or otherwise damaged. Do not use a cord that shows cracks or abrasion damage along its length or at either the plug or appliance end.
- When moving your refrigerator away from the wall, be careful not to roll over or damage the power cord.
- Do not allow children to climb, stand or hang on the shelves in the refrigerator. They could damage the refrigerator and seriously injure themselves.
- If your old refrigerator is still around the house but not in use, be sure to remove the doors. This will reduce the possibility of danger to children.

- After your refrigerator is in operation, do not touch the cold surfaces in the frozen food storage compartment, particularly when hands are damp or wet. Skin may adhere to these extremely cold surfaces.
- If your refrigerator has an automatic icemaker, avoid contact with the moving parts of the ejector mechanism, or with the heating element that releases the cubes. Do not place fingers or hands on the automatic icemaking mechanism while the refrigerator is plugged in.
- Don't refreeze frozen foods which have thawed completely. Food safety experts say:
"... You may safely refreeze frozen foods that have thawed if they still contain ice crystals or if they are still cold—below 40°F (4°C)."
"... Thawed ground meats, poultry or fish that have any off-odor or off-color should not be refrozen and should not be eaten. Thawed ice cream should be discarded. If the odor or color of any food is poor or questionable, get rid of it. The food may be dangerous to eat."
"... Even partial thawing and refreezing reduces the eating quality of foods, particularly fruits, vegetables and prepared foods. The eating quality of red meats is affected less than that of many other foods. Use refrozen foods as soon as possible to save as much of their eating quality as you can."



- **Unplug your refrigerator before cleaning and making repairs.** NOTE: We strongly recommend that any servicing be performed by a qualified individual.
- **Before replacing a burned-out light bulb, the refrigerator should be unplugged** in order to avoid contact with a live wire filament. (A burned-out light bulb may break when being replaced.) NOTE: Turning control to "0" position does not remove power to the light circuit.
- **Do not store or use gasoline or other flammable vapors and liquids in the vicinity of this or any other appliance.**

Mains lead replacement

If the mains lead on your refrigerator needs replacing at any time, it must be replaced by a special lead which is obtainable from your local dealer. A charge will be made for the replacement of the mains lead if you have damaged the lead.

SAVE THESE INSTRUCTIONS

TEMPERATURE CONTROLS

After changing the controls, allow 24 hours for the refrigerator to reach the temperature you set.



Fresh Food

The fresh food control dial has nine settings plus "0." "1" is the warmest. "9" is the coldest. **At first, set the dial at "5."** After using the refrigerator, adjust the dial if necessary.

Insert a coin into the slot in the middle of the dial to turn the dial. Allow 24 hours for the refrigerator to get cold.

NOTE: Turning the dial to "0" stops cooling in both compartments—fresh food and frozen food storage—but does not shut off power to the refrigerator.

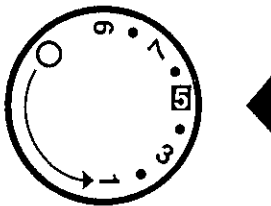

Frozen Food

At first, set the dial at "3." The frozen food control moves a damper to change the amount of cold air that moves from the frozen food compartment to the fresh food compartment.

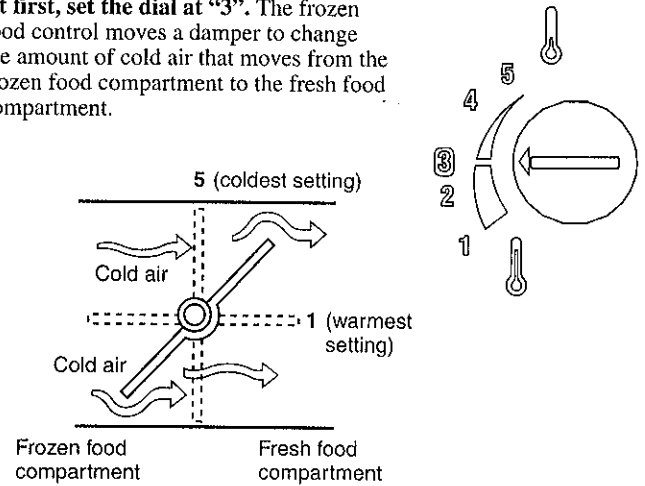

Anti-Condensation Switch

If moisture develops on the ceiling of the fresh food compartment, turn the anti-condensation switch to the ON position. Moisture is likely to appear when the air is humid—in the summer, in the early morning hours or in non-air conditioned rooms. Move to the OFF position in less humid conditions.

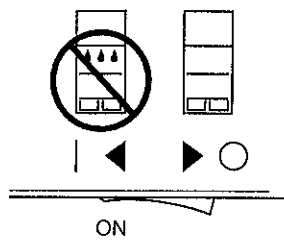

Ambient Room Temperature Limits

This refrigerator is designed to operate in ambient temperatures specified by its Temperature Class which is marked on the rating plate.

Temperature Class	Symbol	Ambient Temperature	
		Maximum	Minimum
Extended-Temperate	SN	32°C	10°C
Temperate	N	32°C	16°C
Subtropical	ST	38°C	18°C
Tropical	T	43°C	18°C

NOTE: Internal temperature may be affected by such factors as the location of the refrigerator, ambient temperature and frequency of door openings. Adjust temperature controls as required to compensate for these factors.

No Defrosting

It is not necessary to defrost the frozen food or fresh food compartment. Although your refrigerator is designed and equipped to defrost itself automatically, some frost on packages is normal.



FRESH FOOD COMPARTMENT SHELVES

Shelf supports at various levels allow you to custom-space shelves

Half-Width Shelves (on some models)

One end of the shelf rests on a molded side-wall support; a bracket on the other end hooks into a track on the rear cabinet wall.

To remove, lift the shelf up at front, then off the support and out of the track.

To replace, select desired shelf height. With shelf front raised slightly, hook the bracket's top lug into the track, then lower the shelf onto the support.

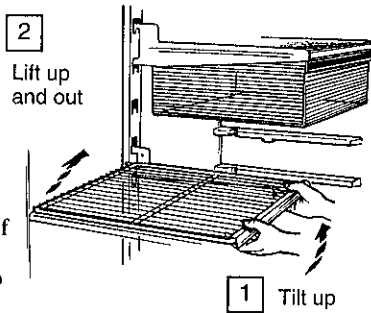

NOTE: The shelf to the right of the track is designed to hook into the right-hand slot; the shelf to the left is designed to hook into the left-hand slot.

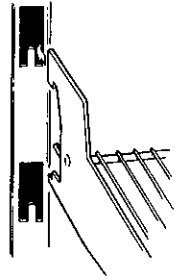

Full-Width Shelves (on some models)

Some models have a steel wire sliding shelf, a stationary tempered glass shelf or two steel wire stationary shelves. These shelves can be moved to another place in the fresh food compartment.

The full-width sliding shelf has stop-locks. When placed correctly on the shelf supports, the shelf will stop before coming completely out of the refrigerator and will not tilt when you place food on it or remove food from it.

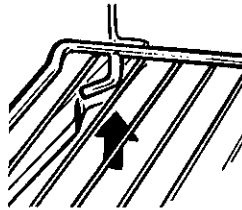

To remove a full-width shelf.

Lift the rear of the shelf and pull forward.

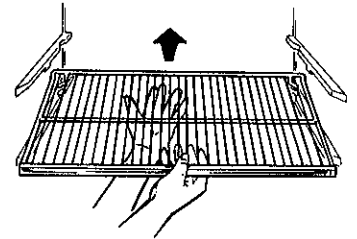

To remove a full-width shelf when the fresh food compartment door cannot be opened fully... lift the rear of the shelf, pull forward and down, tilt the shelf and take it out.

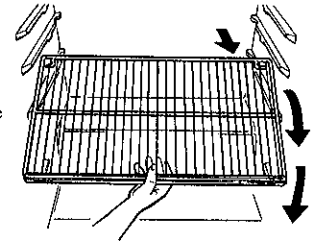

FROZEN FOOD STORAGE COMPARTMENT SHELVES

(on some models)



Some models have an ice-tray shelf and some have a full-width step shelf.

Ice Tray Shelf

To remove the ice tray shelf: Lift the left side of the shelf off its supports, then pull the shelf to the left to free it of the plug supports. Pull the shelf to the right to free the pins from the holes in the cabinet wall.

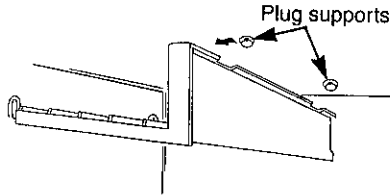

Step Shelf

To remove the step shelf:

To replace the step shelf:

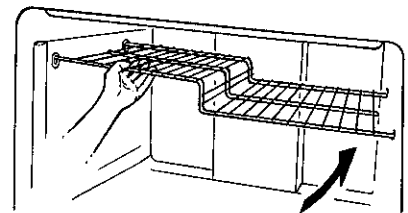
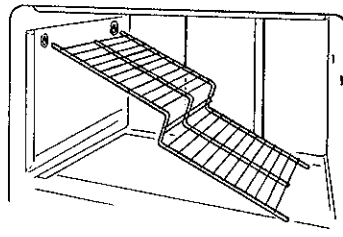
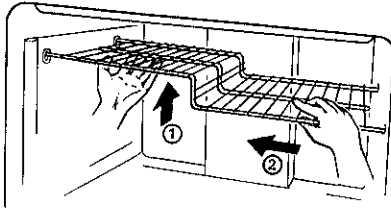

1. Lift left side of shelf slightly.
2. Move shelf to the left to free its right ends from holes in the cabinet wall.
3. Lower right side of shelf, move shelf to the right and take it out.

1. With shelf tilted as shown, fit left ends of shelf into holes in cabinet wall.

2. Lift left side of shelf slightly, swing shelf up, fit right ends of shelf into holes in cabinet wall, and lower shelf into place.

Ice Trays (on some models)

Ice trays are designed to release ice cubes easily. Hold tray upside-down over a container and twist both ends to release cubes.

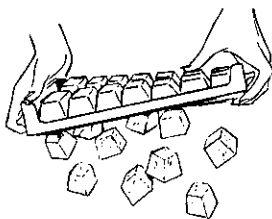

For only one or two ice cubes, leave the tray right-side up, twist both ends slightly and remove desired number of cubes. Wash ice trays and storage bin in lukewarm water only. Do not put them in an automatic dishwasher.

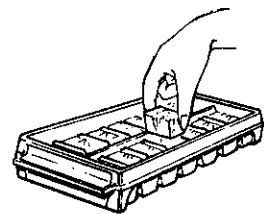



STORAGE DRAWERS

Fruit & Vegetable Drawers

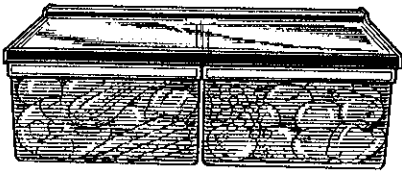

The storage drawers at the bottom of the fresh food compartment are designed to provide high humidity levels required by most vegetables and lower humidity levels required for most fruits.

When replacing the drawers, always push them all the way in.

Storage time will depend upon the type of food and its condition when placed in the drawers.

Excess water which may accumulate in the bottom of the drawers should be emptied and the drawers wiped dry.

High Humidity Drawer

(on some models)

This refrigerated drawer is designed to keep **unwrapped foods** fresh by retaining the natural moisture content of foods such as:

- Artichokes
- Asparagus
- Beets, topped
- Blueberries
- Carrots
- Celery
- Cherries
- Corn
- Currants
- Greens, leafy
- Lettuce
- Parsley
- Peas, green
- Plums
- Radishes
- Rhubarb
- Spinach
- Tomatoes, ripe

As in any refrigerated storage area, it is **recommended that foods with strong odors be stored wrapped**—foods such as:

- Broccoli
- Brussels Sprouts
- Cabbage
- Cauliflower
- Green Onions
- Parsnips
- Turnips

Low Humidity Drawer

(on some models)

This refrigerated drawer is designed to provide lower humidity storage for items such as:

- Apples
- Apricots
- Grapes
- Mushrooms
- Nectarines
- Oranges
- Peaches
- Pears
- Raspberries
- Squash, summer
- Strawberries
- Tangerines

Snacks Drawer (on some models)

The slide-out Snacks Drawer can be removed and taken to the sink or food preparation area. You may also relocate it and the shelf to which it attaches within the fresh food compartment to suit your storage needs.

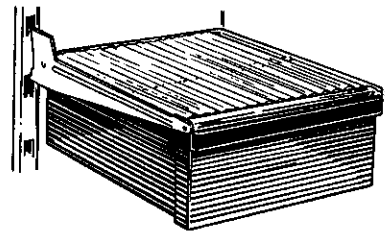

AUTOMATIC ICEMAKER

(on some models)



Your icemaker will produce eight cubes per cycle—approximately 100 cubes in a 24-hour period, depending on frozen food storage compartment temperature, room temperature, number of door openings and other use conditions.

If your refrigerator is operated before the water connection is made to the icemaker, keep the feeler arm in the STOP (up) position.

When the refrigerator is first installed, allow about 24 hours for the frozen food storage compartment to cool down to icemaking temperatures.

Throw away the first few batches of ice. This flushes away impurities in the water line.

When the refrigerator has been connected to the water supply, move the feeler arm to the ON (down) position.

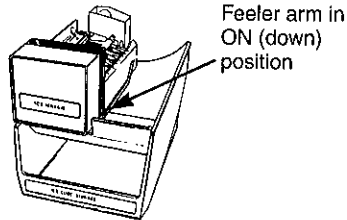
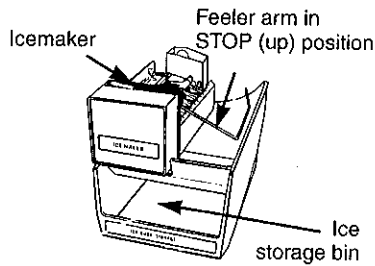

Icemaking will continue until the feeler arm is pushed up to the STOP (up) position by the ice cubes in the storage bin. For maximum ice storage, level the stored cubes with your hand occasionally. Be sure nothing interferes with the swing of the feeler arm.

The icemaker ejects cubes in groups of eight and it is normal for several cubes to be joined together.

Move the icemaker feeler arm to the STOP (up) position when:

- Home water supply is to be off for several hours.
- Ice storage bin is to be removed for a period of time.
- Going away on vacation, at which time you should also turn off the valve in the water supply line to your refrigerator.
- Turning the temperature control dial to the "O" position.

If ice is not used frequently, old ice cubes will become cloudy and taste stale. Empty the ice storage bin periodically and wash it in lukewarm water. Be sure to allow the storage bin to dry before replacing it—otherwise ice cubes may stick to other parts of the icemaker.

If this is your first icemaker, you'll hear occasional sounds that may be unfamiliar. They are normal icemaking sounds and are not a cause for concern.

Water Filter Accessory

Your ice cubes can only be as fresh-tasting as the water that produces them. That's why it's a good idea to purify your water with a water filter.

REMOVES SEDIMENT

Rigid, porous graded density depth cellulose fiber cartridge catches dirt, rust particles, sand and silt.

REMOVES ODORS

Activated charcoal granules remove musty, stale odors.

IMPROVES TASTE

Activated charcoal granules remove oily, medicinal, plastic and metallic tastes.

REDUCES SCALE

Special crystals reduce hard scale deposit formation.

The water filter is an option at extra cost and is available from your local distributor. It has complete installation instructions and installs in minutes on 1/4" O.D. copper water line.

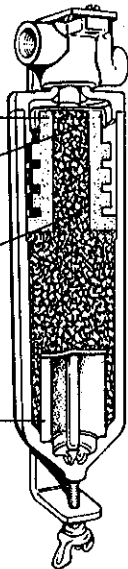

Water Supply Kit

A kit containing copper tubing, shutoff valve, fittings and instructions needed to connect the icemaker to your cold water line is available at extra cost. Contact your local distributor and order the appropriate kit depending on how much copper tubing you need.

Icemaker Accessory Kit

If your refrigerator did not come already equipped with an automatic icemaker, an Icemaker Accessory Kit is available at extra cost from your local distributor. Check the back of the refrigerator for the specific icemaker kit needed for your model.



CARE AND CLEANING

Cleaning—Outside

The door handles and trim (on some models) can be cleaned with a cloth dampened with a solution of mild liquid dishwashing detergent and water. Dry with a soft cloth. Don't use wax on the door handles or trim.

Keep the finish clean. Wipe with a clean cloth lightly dampened with kitchen appliance wax or mild liquid dishwashing detergent. Dry and polish with a clean, soft cloth.

Do not wipe the refrigerator with a soiled dishwashing cloth or wet towel. These may leave a residue that can erode the paint. Do not use scouring pads, powdered cleaners, bleach or cleaners containing bleach because these products can scratch and weaken the paint finish.

Protect the paint finish. The outside of the refrigerator has a high quality, baked-on paint finish. With proper care, it will stay new-looking and rust-free for years. Apply kitchen/appliance wax when the refrigerator is new and then at least twice a year.

Cleaning—Inside

Clean the inside of the fresh food and frozen food storage compartments at least once a year. Unplug refrigerator before cleaning. If this is not practical, wring excess moisture out of sponge or cloth when cleaning around switches, lights or controls. Apply an appliance wax/polish to the inside surface between the doors.

Use warm water and baking soda solution—about a tablespoon (15 ml) of baking soda to a quart (1 l) of water. This both cleans and neutralizes odors. Rinse thoroughly with water and wipe dry.

Other parts of the refrigerator—including door gaskets, vegetable drawers, ice trays and all plastic parts—can be cleaned the same way. After cleaning the door gaskets, apply a thin layer of petroleum jelly to the door gaskets at the hinge side. This helps keep the gaskets from sticking and bending out of shape. Do not use cleansing powders or other abrasive cleaners.

To help prevent odors, leave an open box of baking soda in the rear of the refrigerator, on the top shelf. Change the box every three months. An open box of baking soda in the frozen food storage compartment will absorb stale frozen food storage compartment odors.

Do not wash any of your refrigerator's plastic parts in your automatic dishwasher.

Under Refrigerator

For most efficient operation, you need to keep the area under the refrigerator clean. Turn the temperature control to "O." Sweep away or vacuum dust that is readily accessible on the condenser coils, then turn the control back on.

For best results, use a brush specially designed for this purpose, available from your local distributor. This easy cleaning operation should be done at least once a year.

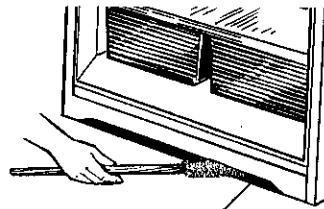

Clean the condenser coils at least once a year.

Behind Refrigerator

Care should be taken in moving your refrigerator away from the wall. All types of floor coverings can be damaged, particularly cushioned coverings and those with embossed surfaces.

Turn the leveling legs at each front corner of the refrigerator counter-clockwise until the rollers support the refrigerator; then pull the refrigerator straight out and return it to position by pushing it straight in. Moving your refrigerator in a side direction may result in damage to your floor covering or refrigerator.

After rolling the refrigerator back into place, turn the legs clockwise until the legs again bear the weight of the refrigerator. Refer to the Rollers and Leveling Legs section.



Drawer and Cover Removal

Drawers at the bottom of the fresh food compartment will stop before coming all the way out of the refrigerator, to help prevent contents from spilling onto the floor. These drawers can be removed easily by lifting the sides up slightly while pulling the drawers past the "stop" location.

Full-Width Drawer with Plastic Cover

(on some models)

To remove the cover, lift it off its supports, pull it forward, tilt it and take it out.

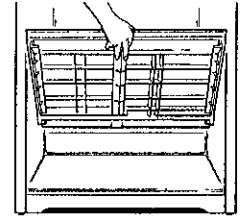

Twin Drawers with Glass Cover (on some models)

To remove the glass cover:

1. Remove the drawers.
2. Reach in, push the front of glass cover up and, at the same time, pull it forward as far as it will come.

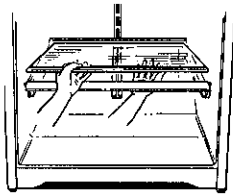

Tilt it and take it out. Avoid cleaning the cold glass cover with hot water because the extreme temperature difference may cause it to break.

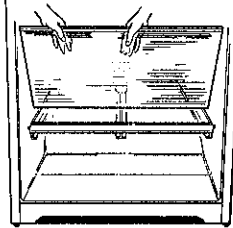

3. Remove the drawer frame. (Always remove the glass cover before you take out the drawer frame.)

Lift the frame off the supports at each side and back, pull it forward, tilt it and take it out.

To replace the glass cover:

1. Lower the frame until it rests on the supports at each side and back.
2. Replace the glass cover, pushing its rear edge firmly into the rear frame channel and gently lowering the front into place.
3. Replace the drawers.

Light Bulb Replacement (on some models)

A light bulb and socket are located at the top of the fresh food compartment opposite the temperature control panel.

To replace the bulb, first unplug the refrigerator from its electrical outlet. Put your hand under the light shield and release the hook at the bulb end of the shield. (The light shield is on some models.)

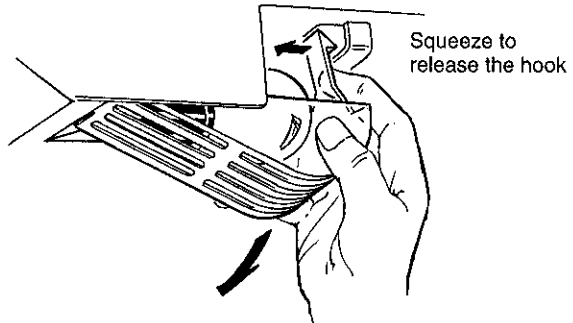

Squeeze to release the hook



PREPARATION

Clearances

Allow the following clearances for ease of installation, proper air circulation and plumbing and electrical connections:

Sides	19 mm
Top.....	25 mm
Back.....	25 mm

Water Supply to Icemaker (on some models)

If your refrigerator has an icemaker, or if you plan to add an icemaker later, the icemaker will have to be connected to a cold drinking water line.

A water supply kit containing copper tubing, shutoff valve, fittings and instructions is available at extra cost from your local distributor. There should be sufficient tubing from the cold water supply to the icemaker inlet to allow moving the refrigerator out from the wall several feet (approximately 244 cm of 1/4" copper tubing in three 25 cm diameter coils).

Do not use kits with plastic tubing since there is water pressure in the supply line at all times.

Maximum permissible inlet water pressure—8.3 bars.

Minimum permissible inlet water pressure—1.4 bars.

Installation of icemaker must be made by a qualified service technician.

Rollers and Leveling Legs

Leveling legs near each front corner of the refrigerator are adjustable. They firmly position the refrigerator and prevent it from moving when the doors are opened. Leveling legs should be set so the front of the refrigerator is raised just enough that the doors close easily when opened about halfway.

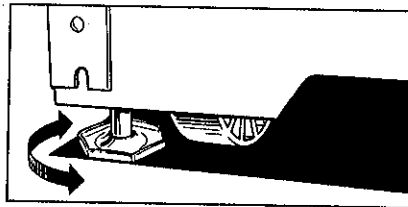

Turn the leveling legs clockwise to raise the refrigerator, counterclockwise to lower it.

Rollers next to the leveling legs allow you to move the refrigerator away from the wall for cleaning.

Turn the legs counterclockwise until the weight of the refrigerator is transferred from them to the rollers. After rolling the refrigerator back into place, turn the legs clockwise until the legs again bear the weight of the refrigerator.

When You Go on Vacation

For shorter vacations, remove perishable foods and leave controls at regular settings. However, if room temperature is expected to drop below 16°C, follow the same instructions as for extended vacations.

For extended vacations or absences, shut off the power to the refrigerator, move the fresh food control to the "O" position, and clean the interior with a baking soda solution of 15 ml of baking soda to 1 liter of water. Wipe dry. To prevent odors, leave an open box of baking soda in the refrigerator. Leave doors open.

Move icemaker feeler arm to STOP (up) position and be sure to shut off water supply to the refrigerator.

When You Move

Disconnect power cord from wall outlet, remove all food, and clean and dry the interior.

Secure all loose items such as grille, shelves, storage drawers and ice trays by taping them securely in place to prevent damage, and raise leveling legs.

Be sure refrigerator stays in upright position during actual moving and in van. Refrigerator must be secured in van to prevent movement. Protect outside of refrigerator with blanket.

Dimensions

Model	14	16
A*	155 cm	163 cm
B	71 cm	71 cm
C**	75 cm	75 cm
D	138 cm	138 cm
E	62 cm	62 cm

* Height does not include hinge—Add 22 mm for hinge.

** Depth includes handle.

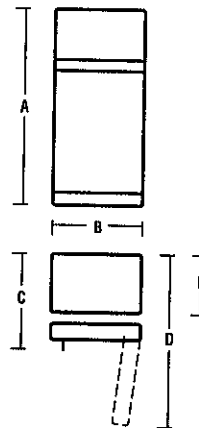

INSTALLATION REQUIREMENTS

IMPORTANT...Please Read Carefully



Electrical Requirements

The refrigerator should always be plugged into its own individual electrical outlet. This is recommended for best performance and to prevent overloading house wiring circuits, which could cause a fire hazard from overheated wires. Please refer to the rating plate on the refrigerator for the correct voltage, wattage and frequency.

The refrigerator must be positioned so that the plug is accessible.

WARNING: HOW TO AVOID ACCIDENTS TO CHILDREN WHEN DISCARDING AN OLD REFRIGERATOR OR FREEZER BE CERTAIN TO MAKE THE LOCK UNUSABLE. IF POSSIBLE, REMOVE THE DOORS AND DISCARD SEPARATELY. DO NOT ATTEMPT TO STAND ON TOP OF YOUR APPLIANCE. IT IS NOT DESIGNED FOR SUCH USE AND YOU COULD INJURE YOURSELF OR DAMAGE THE APPLIANCE BY SUCH ABUSE. CHILDREN SHOULD NOT BE ALLOWED TO PLAY WITH THE APPLIANCE OR TAMPER WITH THE CONTROLS.

How to Connect Electricity

For personal safety, this appliance must be properly earthed.

The power cord of this appliance is equipped with an earthing plug which mates with a standard earthed wall outlet to minimize the possibility of electric shock hazard from this appliance.

Have the wall outlet and circuit checked by a qualified electrician to make sure the outlet is properly earthed.

Where an unearthed wall outlet is encountered, it is your personal responsibility and obligation to have it replaced with a properly earthed wall outlet.

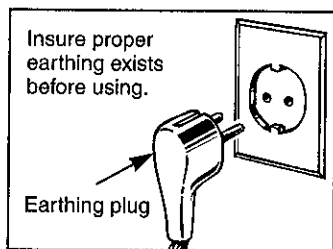

If the product plug does not fit your outlet, the product should be fitted with a new plug.

IMPORTANT: The refitting of electric plugs and cables should be done by a qualified technician or service agent. In some countries the refitting of electric plugs and cables is only permitted when the work is completed by a qualified technician.

If the power supply cord becomes damaged, it must be replaced by a qualified service agent in order to avoid a safety hazard.



INSTALLATION INSTRUCTIONS

FOR GREAT BRITAIN AND IRELAND ONLY

Electrical Requirements

We recommend that this appliance be connected to the mains supply via a suitable switched socket in a readily accessible position. All appliances come complete with a fitted plug. The plug on your refrigerator has a 13A fuse. If the plug does not fit your sockets, a new plug can be fitted. Cut off the old plug and throw it away. Do not insert it into a socket elsewhere in the house as this could cause a shock.

WARNING: THIS APPLIANCE MUST BE EARTHED.

IMPORTANT: Fitting a Different Plug

The wires in the mains lead are coloured in accordance with the following code: Green and Yellow-Earth; Blue-Neutral; Brown-Live. If you fit your own plug the colours of these wires may not correspond with the identifying marks on the plug terminals. This is what you have to do:

1. Connect the green and yellow (earth) wire to the terminal in the plug marked 'E' with the symbol or coloured green or green and yellow.
2. Connect the blue (Neutral) wire to the terminal in the plug marked 'N' or coloured black.
3. Connect the brown (Live) wire to the terminal marked 'L' or coloured red.

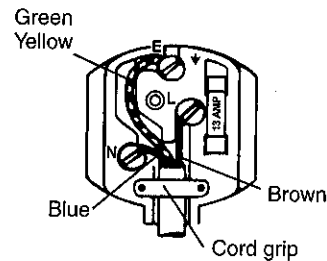

With alternative plug, a 15A fuse must be fitted either in the plug or adapter or in the main fuse box. In the event of replacing a fuse in the plug supplied, a 13A ASTA-approved fuse to BS1362 must be fitted.

If the plug is the moulded-on type, the fuse cover must be refitted when changing the fuse. In the event of losing the fuse cover, the plug must not be used until a replacement fuse cover has been obtained and fitted. A new fuse cover can be obtained from your nearest service centre or local electricity board. The colour of the correct replacement fuse cover is that of the coloured marks or insert in the base of the plug.

Mains Lead Replacement

If the mains lead on this appliance needs replacing at any time, it must be replaced by a special lead which is obtainable from your nearest service centre. A charge will be made for the replacement of the mains lead if you have damaged it.

REVERSING THE DOOR SWING



These instructions are for changing the hinges from the right side to the left side.

If you ever want to change the hinges back to the right side, follow these same instructions (merely reverse all references to left and right).

BEFORE YOU BEGIN

- Read these instructions all the way through before starting.
- Unplug the refrigerator from its electrical outlet.
- Empty all door shelves, including the dairy compartment.
- Provide a non-scratching work surface for the doors.

ONCE YOU BEGIN

- Handle parts carefully to avoid scratching paint.
- Set screws down by their related parts to avoid using them in the wrong places.
- When reinstalling door hinges, be sure to use the same number of shims and washers as were originally used.
- **IMPORTANT:** Once you begin, do not move the cabinet until the door-swing reversal is completed.

TOOLS REQUIRED

- 5/16" hex-head socket screwdriver
- Putty knife or thin-blade screwdriver
- T20 or T25 Torxdriver
- Phillips screwdriver
- Masking tape
- 5/16" open-end wrench

1 REMOVE THE FROZEN FOOD STORAGE COMPARTMENT DOOR.

- a. Tape the door shut with masking tape.
- b. Use a 5/16" hex-head socket screwdriver to remove the screws that hold the top hinge to the cabinet.
- c. Lift the hinge (and shim glued to it) straight up to free the hinge pin from the socket in the top of the door and set it aside, along with its screws.

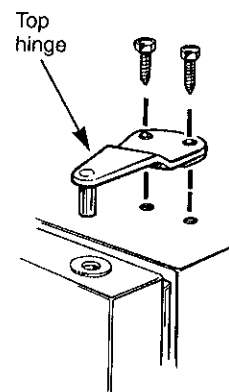

- d. Remove tape, tilt the door away from the cabinet, and carefully lift the door to free its bottom socket from the hinge pin on the center hinge bracket.
- e. Set the door on a non-scratching surface with the outside up.
- f. Using a Torxdriver, transfer the two screws from the opposite side of the cabinet to the screw holes vacated by the top hinge removal.

2 REMOVE THE FRESH FOOD DOOR.

- a. Tape the door shut with masking tape.
- b. Use a 5/16" hex-head socket screwdriver and 5/16" open-end wrench to remove the two screws holding the center hinge (and shim glued to it) to the cabinet. Lift the center hinge to free its pin from the socket in the top of the door, and set hinge and screws aside.

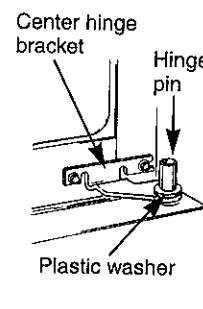

- c. Remove tape, tilt door away from cabinet, and lift it from the pin in the bottom hinge bracket. (If the plastic washer sticks to the door bottom, put it back on the hinge.)
- d. Set door outside-up on a non-scratching surface.
- e. Using a Torxdriver, transfer the two screws from the opposite side of the cabinet to the screw holes vacated by the center hinge removal.
- f. Take one of the screws removed in step (b) and start it in the outermost screw hole on the opposite side. Do not drive it all the way down—leave enough space under the screw head for thickness of shim and bracket.

(continued next page)



REVERSING THE DOOR SWING

(Continued)

3 REVERSE CABINET HARDWARE.

1. Transfer the bottom hinge to the left.

a. Remove the base grille if your refrigerator has one. Grasp it at the bottom and pull it straight out.

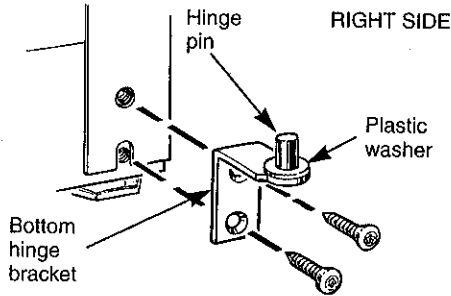

b. Using a Torxdriver, remove the hinge bracket (and shim glued to it), and plastic washer from the bottom right side of the cabinet.

c. Reinstall the hinge bracket (and shim glued to it) and plastic washer on the bottom left side of the cabinet.

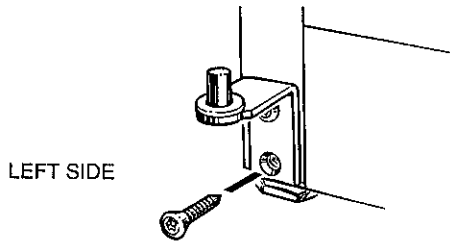

2. Transfer the top hinge to the left.

Reinstall the top hinge (and shim glued to it) on the left front corner of the cabinet, but do not tighten the screws at this time.

Some hinges have four holes. Which holes you use for installing the hinge depends on which side you install the hinge.

The outer edge of the hinge should be parallel to the edge of the case for correct installation.

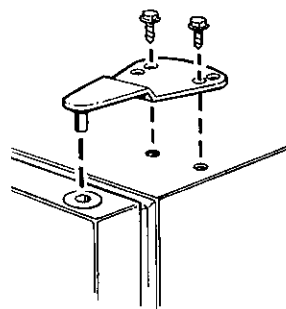
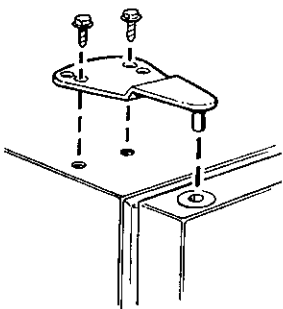

4 REVERSE THE DOOR HANDLES.

(on some models)

1. Transfer the fresh food door handle to the right.

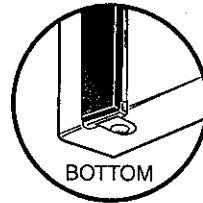
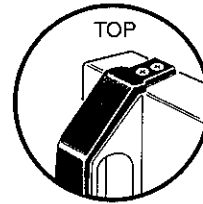

To remove the handle...

a. Remove the handle plug using a tape-tipped putty knife under the edge, and remove the screw underneath.

b. Remove two screws holding the handle to the top of the door.

c. Remove the handle.

After removing the handle...

a. Remove the screws from the right edge of the door top and insert them into the handle screw holes on the opposite side.

b. With tape-tipped putty knife or thin-blade screwdriver, pry out the plug button from the hinge hole on the left side of the door and insert it into the hole on the opposite side that was vacated by removal of the top hinge.

c. Pull the plug button from the front of the door and transfer it to the opposite side.

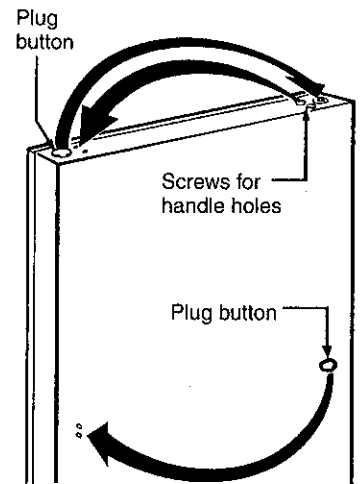

2. Transfer the door stop.

LEFT SIDE

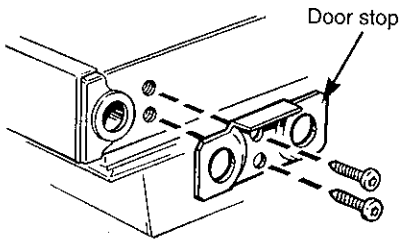

- Move the metal door stop from the right end to the left end. Use a Torxdriver.

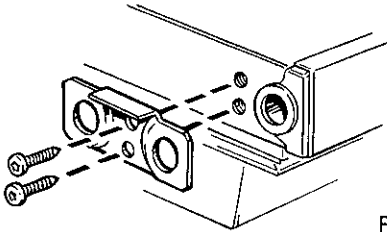

- Move any screws from the left end to the right end.

When reinstalling the fresh food door handle...

- Attach the handle to the right side of the door with screws at the top and under the handle plug.
- Reinstall the handle plug.

3. Transfer the frozen food storage compartment door handle to the right.

- Remove the screw holding the handle to the top of the door and the two screws holding the handle to the bottom of the door.
- Remove the handle.
- Remove the screw from the right top edge of the door and insert it into the handle screw hole on the left side.
- Transfer the door stop as shown above.

- Attach the handle to the right edge of the door with screws at top and bottom, using bottom holes vacated by removal of the door stop screws.

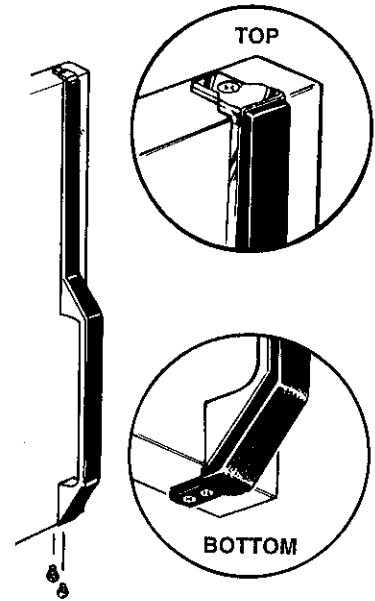

5 REHANG THE FRESH FOOD DOOR.

- Lower the bottom socket of the fresh food door onto the pin on the bottom hinge. Be sure the plastic washer is in place on the pin.

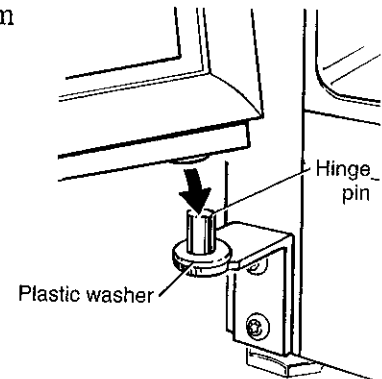

- Insert the pin on the center hinge into the socket in the top of the door. **NOTE:** The center hinge must be turned over as shown when mounted on the left side.

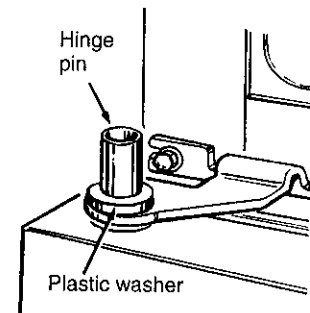

- Tilt the door toward the cabinet. As the door is brought into position, slide the hinge under the head of the screw which earlier had been partly driven into the outermost hole. Insert the remaining screw, then tighten both screws securely.

(continued next page)



REVERSING THE DOOR SWING

(continued)

6 REHANG THE FROZEN FOOD STORAGE COMPARTMENT DOOR.

a. Lower the bottom socket of the frozen food storage compartment door onto the center hinge pin. Be sure the washer is in place on the pin.

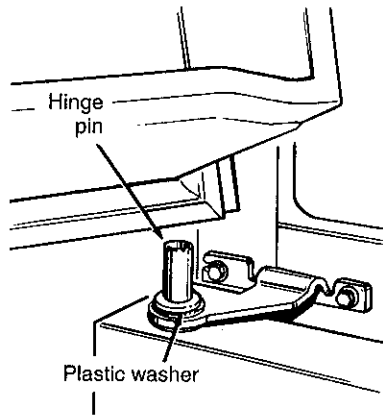

b. Tilt the door toward the cabinet, lifting the top hinge so the pin fits into the socket on the top of the door.

c. Before tightening the top hinge screws, make sure the top of the door is level with the cabinet top and the space between the doors is equal across the entire front. Do not overtighten these screws—tighten them until they are just snug, then turn them in another one-half turn.

7 EXAMINE THE DOOR GASKETS.

Check the door gaskets all around, making sure no gaps are visible between the gaskets and the cabinet. If a gap shows, try stretching the gasket away from the door so the magnet in the gasket will contact the cabinet surface, being careful not to dislodge the gasket.

8 RELOCATE THE PLASTIC-COVERED SNACKS DRAWER. (on some models)

For convenient access to the Snacks Drawer after reversing the door swing, you can move the drawer to the other side of the cabinet.

1. Slide the drawer out and remove the shelf to which it was attached.
2. Remove the other half-width shelf.

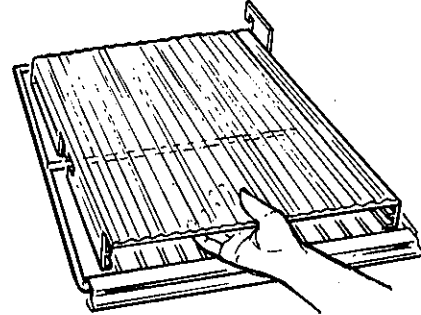

3. Push the drawer cover forward and up off the shelf.

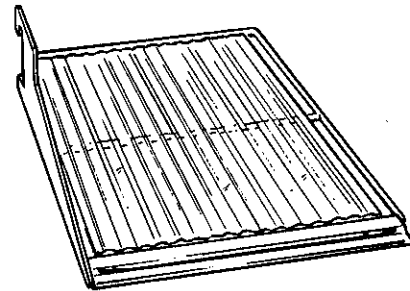

4. Put the cover on the other half-width shelf as shown, flush to the side with the shelf-locking lugs. Return both shelves to the refrigerator and slide the Snacks Drawer into its relocated cover.

WATER LINE INSTALLATION



CAUTION:

- If you use your refrigerator before connecting the water line, make sure the icemaker feeler arm is kept in the STOP (up) position.
- Do not install the icemaker tubing in areas where temperatures fall below 32°F (0°C).
- When using any electrical device (such as a power drill) during installation, be sure the device is insulated or wired in a manner to prevent the hazard of electric shock.
- All installations must be in accordance with local plumbing code requirements.

WHAT YOU WILL NEED

- A **cold water supply** is required for automatic icemaker operation. The water pressure must be between 20 and 120 p.s.i. (1.4 and 8.3 bars).
- **Power drill**, unless you have a self-piercing valve.
- **Copper tubing**, 1/4" outer diameter, to connect the refrigerator to the water supply. Be sure both ends of the tubing are cut square.

To determine how much copper tubing you need: measure the distance from the water valve on the back of the refrigerator to the water supply pipe. Then add 8 feet (244 cm). Be sure there is sufficient extra tubing [about 8 feet (244 cm) coiled into 3 turns of about 10 inches (25 cm) diameter] to allow the refrigerator to move out from the wall after installation. Do not use plastic tubing or plastic fittings because the water supply line is under pressure at all times. Also, certain types of plastic tubing may become brittle with age and crack, resulting in water leakage.

• **Shutoff valve** to connect to the cold water line. The shutoff valve should have a water inlet with a minimum inside diameter of 5/32" at the point of connection to the COLD WATER LINE. Saddle-type shutoff valves are included in many water supply kits. Before purchasing, make sure a saddle-type valve complies with your local plumbing codes.

• Two 1/4" outer diameter **compression nuts** and 2 **ferrules (sleeves)**—to connect the copper tubing to the shutoff valve and the refrigerator water valve.

• If your existing water line has a flared fitting at the end, you will need an **adapter** (available at plumbing supply stores) to connect the water line to the refrigerator OR—you can cut off the flared fitting with a **tube cutter** and then use a compression fitting.

WARRANTY INFORMATION

This water line installation is not warranted by the refrigerator or icemaker manufacturer. Follow these instructions carefully to minimize the risk of expensive water damage.

1 SHUT OFF THE MAIN WATER SUPPLY.

Turn on the nearest faucet long enough to clear the line of water.

2 INSTALL THE SHUTOFF VALVE ON THE NEAREST FREQUENTLY USED DRINKING WATER LINE.

Typical ways to connect to water supply

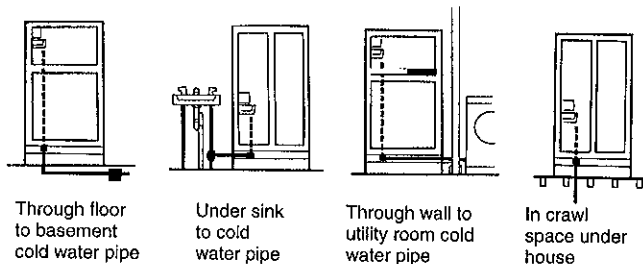

a. Choose a location for the valve that is easily accessible. It is best to connect into the side of a vertical water pipe. When it is necessary to connect into a horizontal water pipe, make the connection to the top or side, rather than at the bottom, to avoid drawing off any sediment from the water pipe.

b. Drill a 1/4" hole in the water pipe, using a sharp bit. Remove any burrs resulting from drilling the hole in the pipe. (Do not drill a hole if the valve is a self-piercing type.)

c. Fasten the shutoff valve to the cold water pipe with the pipe clamp.

d. Tighten the clamp screws until the sealing washer begins to swell. Do not overtighten or you may crush the copper tubing.

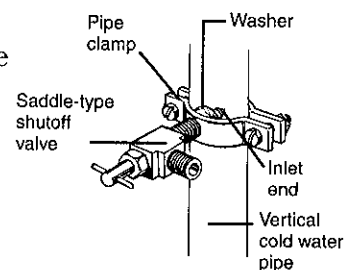

(continued next page)



WATER LINE INSTALLATION

(continued)

3 ROUTE THE COPPER TUBING BETWEEN THE COLD WATER LINE AND THE REFRIGERATOR.

Route the tubing through a hole drilled in the floor or wall (behind the refrigerator or adjacent base cabinet) as close to the wall as possible. Be sure there is sufficient extra tubing [about 8 feet (244 cm) coiled into 3 turns of about 10" (25 cm) diameter] to allow the refrigerator to move out from the wall after installation.

4 CONNECT THE COPPER TUBING TO THE SHUTOFF VALVE.

Place the compression nut and ferrule (sleeve) onto the end of the tubing and connect it to the shutoff valve. Make sure the tubing is fully inserted into the valve. Tighten the compression nut securely.

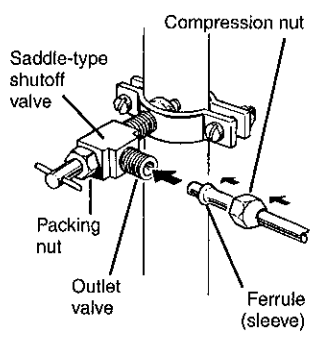

5 TURN ON THE WATER AND FLUSH OUT THE TUBING.

- a. Turn the main water supply on and flush out the tubing until the water is clear.
- b. Shut the water off at the water valve after about one quart (1 l) of water has been flushed through the tubing.

6 CONNECT THE COPPER TUBING TO THE REFRIGERATOR.

Before making the connection to the refrigerator, be sure the refrigerator power cord is not plugged into the wall outlet. We recommend installing a water filter (available from your local distributor) if your water supply has sand or particles that could clog the screen of the refrigerator's water valve. Install it in the water line near the refrigerator.

- a. Remove the plastic flexible cap from the water valve.
- b. Place the compression nut and ferrule (sleeve) onto the end of the tubing as shown.
- c. Insert the end of the copper tubing into the water valve connection as far as possible. While holding the tubing, tighten the fitting.

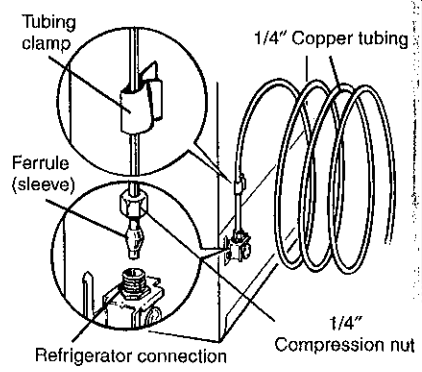

- d. Fasten the copper tubing into the clamp provided to hold it in a vertical position. You may need to pry open the clamp.

7 TURN THE WATER ON AT THE SHUTOFF VALVE.

Tighten any connections that leak.

8 PLUG THE REFRIGERATOR POWER CORD INTO A GROUNDED ELECTRICAL OUTLET.

9 SET THE ICEMAKER FEELER ARM TO THE ON (DOWN) POSITION.

The icemaker will not begin to operate until it reaches its operating temperature of 15° F (-9° C), or below. It will then begin operation automatically if the icemaker is in the ON (down) position.

NOTE: The icemaker may double-cycle when it first starts, causing some water spillage from the icemaker into the ice bucket. This is normal and should not happen again. The first few batches of cubes should be thrown away, so that remaining impurities in the water line will be flushed out.

10 MOVE THE REFRIGERATOR BACK TO THE WALL.

Arrange the coil of copper tubing so that it does not vibrate against the back of the refrigerator or against the wall.

QUESTIONS? USE THIS PROBLEM SOLVER



PROBLEM	POSSIBLE CAUSE
REFRIGERATOR DOES NOT OPERATE	<ul style="list-style-type: none"> • May be in defrost cycle when motor does not operate for about 30 minutes. • Fresh food control in "O" position. • If interior light is not on, refrigerator may not be plugged in at wall outlet. • If plug is secure and the refrigerator still fails to operate, plug a lamp or a small appliance into the same outlet to determine if there is a tripped circuit breaker or burned-out fuse.
MOTOR OPERATES FOR LONG PERIODS	<ul style="list-style-type: none"> • Modern refrigerators with more storage space and a larger frozen food storage compartment require more operating time. • Normal when refrigerator is first delivered to your home—usually requires 24 hours to completely cool down. • Large amounts of food placed in refrigerator to be cooled or frozen. • Hot weather—frequent door openings. • Door left open. • Temperature controls are set too cold. Refer to Temperature Controls section. • Grille and condenser need cleaning. Refer to Care and Cleaning section.
MOTOR STARTS AND STOPS FREQUENTLY	<ul style="list-style-type: none"> • Fresh food control starts and stops motor to maintain even temperatures.
VIBRATION OR RATTLING	<ul style="list-style-type: none"> • If refrigerator vibrates, more than likely it is not resting solidly on the floor. The front leveling legs need adjusting, or floor is weak or uneven. Refer to Rollers and Levelling Legs in the Preparation section. • If dishes vibrate on shelves, try moving them. Slight vibration is normal.

NORMAL OPERATING SOUNDS

These sounds are normal and do not indicate a need for service.

The new high efficiency compressor runs faster and will have a higher pitch hum or pulsating sound while operating.

Sizzling sound in the frozen food storage compartment during the defrost cycle, caused by frost thawing and draining.

Defrost timer and refrigerator control click on and off.

The fan circulating air inside the frozen food storage compartment which keeps the temperatures throughout.

Water dropping on the defrost heater causing a sizzling, hissing or popping sound during the defrost cycle.

The flow of refrigerant through the frozen food storage compartment cooling coils sounds like boiling water or a gurgling noise.

Cracking or popping of cooling coils caused by expansion and contraction during defrost and refrigeration following defrost.

Water dripping as it melts from the evaporator and flows to the drain pan during the defrost cycle.

Icemaker (on some models): The icemaker water valve will buzz when the icemaker fills with water. If the feeler arm is in the ON (down) position it will buzz even if it has not yet been hooked up to water. Keeping the feeler arm in the ON (down) position before it is hooked up to water can damage the icemaker. To prevent this, raise the feeler arm to the STOP (up) position. This will stop the buzzing.

The sound of cubes dropping into the bin and water running in pipes as icemaker refills.

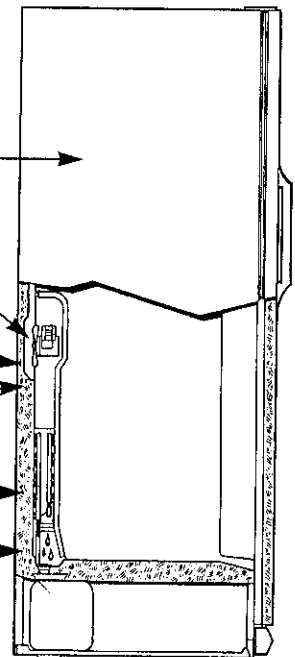

(continued next page)



PROBLEM SOLVER

(continued)

PROBLEM	POSSIBLE CAUSE
FOODS DRY OUT	<ul style="list-style-type: none">• Foods not covered, wrapped or sealed properly.
FRESH FOOD OR FROZEN FOOD STORAGE COMPARTMENT TEMPERATURE TOO WARM	<ul style="list-style-type: none">• Temperature controls not set cold enough. Refer to Temperature Controls section.• Warm weather—frequent door openings.• Door left open for too long a time.• Package holding door open or blocking air duct in frozen food storage compartment.
FROST OR ICE CRYSTALS ON FROZEN FOOD	<ul style="list-style-type: none">• Door may have been left ajar or package holding door open.• Too frequent or too long door openings.• Frost within package is normal.
AUTOMATIC ICEMAKER DOES NOT WORK (on some models)	<ul style="list-style-type: none">• Icemaker feeler arm is in STOP (up) position.• Water supply turned off or not connected.• Frozen food storage compartment too warm.• Piled up cubes in the storage bin may cause icemaker to shut off prematurely. Remove storage bin from freezer and level cubes by hand.
CUBES TOO SMALL	<ul style="list-style-type: none">• Water shutoff valve connecting refrigerator to home water line may be clogged.
SLOW ICE CUBE FREEZING	<ul style="list-style-type: none">• Door may have been left ajar.• Temperature controls set too warm. Refer to Temperature Controls section.
ICE CUBES HAVE ODOR/TASTE	<ul style="list-style-type: none">• Ice storage bin needs to be emptied, washed and old cubes need to be discarded.• Unsealed packages in fresh food and/or frozen food storage compartments may be transmitting odor/taste to ice cubes.• Interior of refrigerator needs cleaning. Refer to Care and Cleaning section.
MOISTURE FORMS ON CABINET SURFACE BETWEEN THE DOORS	<ul style="list-style-type: none">• Not unusual during periods of high humidity.• Move the anti-condensation switch to the ON position.
MOISTURE COLLECTS INSIDE	<ul style="list-style-type: none">• Too frequent or too long door openings.• In humid weather, air carries moisture into refrigerator when doors are opened.• Move the anti-condensation switch to the ON position.
REFRIGERATOR HAS ODOR	<ul style="list-style-type: none">• Foods with strong odors should be tightly covered.• Check for spoiled food.• Interior needs cleaning. Refer to Care and Cleaning section.• Defrost water drainage system needs cleaning.• Keep open box of baking soda in refrigerator; replace every three months.
HOT AIR FROM BOTTOM OF REFRIGERATOR	<ul style="list-style-type: none">• Normal air flow cooling motor. In the refrigeration process, it is normal that heat be expelled in the area under the refrigerator. Some floor coverings will discolor at these normal and safe operating temperatures. Your floor covering supplier should be consulted if you object to this discoloration.
FOOD FREEZING IN THE REFRIGERATOR	<ul style="list-style-type: none">• Move the food away from the air vent (near the controls).• Temperature controls set too cold. Refer to Temperature Controls section.