

# Operation Manual

## R150 PLUS/300 PLUS/500 PLUS Reference Amplifier

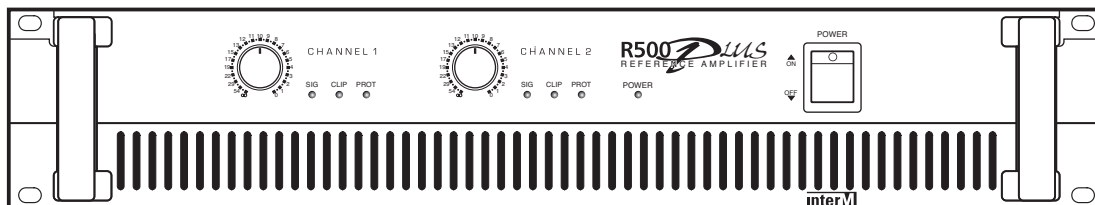

\* Rack mount products in the Western Hemisphere(North America, South America, and the Caribbean) do not have handles installed due to customer preference.

**interM**

# Contents

<b>Welcome</b>	
Warning.....	1
Unpacking.....	2
Short Form Instructions.....	2
<b>Installation</b>	
Environment.....	3
Important Safety Instructions.....	3
<b>Description</b> .....	4
<b>Features</b> .....	4
Accessories.....	4
<b>Front Panel</b> .....	5
<b>Rear Panel</b> .....	6
<b>Mounting in a Rack</b> .....	7
<b>Applications</b>	
Stereo Installation.....	8
Bridge Mono Installation.....	9
Linked Installation.....	10
<b>Connections</b> .....	11
<b>Block Diagram</b> .....	13
<b>Specifications</b> .....	14
<b>Service</b>	
Procedures.....	15
Schematic.....	15
Parts List.....	15
<b>Variations and Options</b> .....	15
<b>Warranty</b> .....	15

# Welcome

## A personal welcome to you from the management and employees of Inter-M

All of the co-workers here at Inter-M are dedicated to providing excellent products with inherently good value, and we are delighted you have purchased one of our products.

We sincerely trust this product will provide years of satisfactory service, but if anything is not to your complete satisfaction, we will endeavor to make things right.

Welcome to Inter-M, and thank you for becoming part of our worldwide extended family!

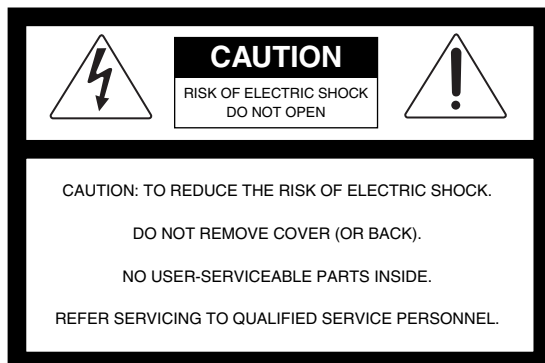

## WARNING

To prevent fire or shock hazard, do not expose the unit to rain or moisture.

\*Do not install this equipment in a confined space such as a book case or similar unit.

\*The apparatus shall not be exposed to dripping or splashing and no objects filled with liquids, such as vases, shall be placed on the apparatus.

\*Worded: "WARNING FOR YOUR PROTECTION PLEASE READ THE FOLLOWING-WATER AND MOISTURE: Unit should not be used near water(e.g. near a bathtub, washbowl, kitchen sink, laundry tub, in a wet basement, or near a swimming pool, etc). Care should be taken so that objects do not fall and liquids are not spilled into the enclosure through openings."



This symbol is intended to alert the user to the presence of uninsulated "dangerous voltage" within the product's enclosure that may be of sufficient magnitude to constitute a risk of electric shock to persons.



This symbol is intended to alert the user to the presence of important operation and maintenance (servicing) instructions in the literature accompanying the appliance.

Caution: To prevent electric shock do not use this (polarized) plug with an extension cord, receptacle or other outlet unless the blades can be fully inserted to prevent blade exposure.

Attentions: Pour prévenir les chocs électriques ne pas utiliser cette fiche polarisée avec un prolongateur, une prise de courant ou une autre sortie de courant, sauf si les lames peuvent être insérées à fond sans en laisser aucune partie à découvert.

## Unpacking

Please take a few minutes to read this manual to familiarize yourself with important information regarding installation, product features, and operation.

As with most electronic devices, ORIGINAL PACKAGING (OR EQUAL) IS REQUIRED in the unlikely event that the product needs to be returned for servicing.

## Short Form Instructions

1. Do not connect the AC power until step 6. The POWER switch should be in the OFF position.
2. Adjust both of the LEVEL controls to the fully attenuated position (turn counter-clockwise).
3. Connect an appropriate line level input signal to either the balanced XLR or the balanced 1/4" TRS (Tip-Ring-Sleeve) connector marked INPUTS.
4. Move the MODE selector to the desired position. The Stereo position is the most common.
5. Connect the OUTPUTS to the speaker load according to the mode of operation determined in the previous step.
6. With the power switch in the OFF position, plug in the supplied Universal AC power cord to the product and an appropriate AC source.
7. Depress the power switch to the ON position. The power switch will illuminate.
8. The product is ready for operation. Slowly increase the LEVEL control to the desired operating level. Avoid illuminating the PEAK indicator and do not apply too much power to the speakers.
9. Operate the product and the system in a manner which DOES NOT illuminate the PEAK warning indicator.

# Installation

## Environment

Never place this product in an environment which could alter its performance or reduce its service life. Such environments usually include high levels of heat, dust, moisture, and vibration.

## Important Safety Instructions

1. Read these instructions.
2. Keep these instructions.
3. Heed all warnings.
4. Follow all instructions.
5. Do not use this apparatus near water.
6. Clean only with dry cloth.
7. Do not block any ventilation openings. Install in accordance with the manufacturer's instructions.
8. Do not install near any heat sources such as radiators, heat registers, stoves, or other apparatus (including amplifiers) that produce heat.
9. Do not defeat the safety purpose of the polarized or grounding-type plug. A polarized plug has two blades with one wider than the other. A grounding type plug has two blades and a third grounding prong. The wide blade or the third prong are provided for your safety. If the provided plug does not fit into your outlet, consult an electrician for replacement of the obsolete outlet.
10. Protect the power cord from being walked on or pinched particularly at plugs, convenience receptacles, and the point where they exit from the apparatus.
11. Only use attachments/accessories specified by the manufacturer.
12. Use only with the cart, stand, tripod, bracket, or table specified by the manufacturer, or sold with the apparatus. When a cart is used, use caution when moving the cart/apparatus combination to avoid injury from tip-over.
13. Unplug this apparatus during lightning storms or when unused for long periods of time.
14. Refer all servicing to qualified service personnel. Servicing is required when the apparatus has been damaged in any way, such as power-supply cord or plug is damaged, liquid has been spilled or objects have fallen into the apparatus, the apparatus has been exposed to rain or moisture, does not operate normally, or has been dropped.



## Description

- R150 PLUS  
A 2U rack space, 2 channel amplifier capable of 150W into 8Ω load (bridged mono).
- R300 PLUS  
A 2U rack space, 2 channel amplifier capable of 300W into 8Ω load (bridged mono).
- R500 PLUS  
A 2U rack space, 2 channel amplifier capable of 500W into 8Ω load (bridged mono).

## Features

- 4Ω stable per channel (stereo), 8Ω stable (bridge mono)
- 2U rack space
- Front panel indicators for signal strength, clip, protect, and power
- Rack Ears for permanent installation in a standard 19" (rack mount width) enclosure.
- Detachable AC power cord

### Accessories

One detachable AC power cord is provided for use with this product.

## Front Panel

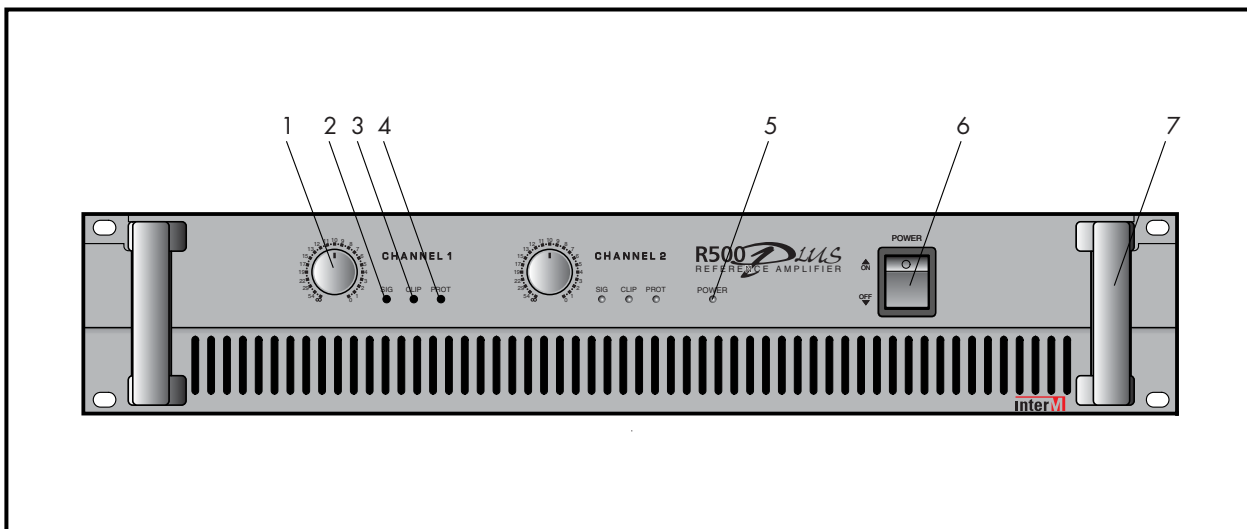

### 1. LEVEL CONTROL

This determines the level of the input signal for each channel. In stereo mode the knobs will determine the signal level independently for each channel. In the bridge mono mode only the channel 1 level control is used.

### 2. SIGNAL INDICATOR

This indicates the level of the input signal. This should be illuminated during normal operation.

### 3. CLIP INDICATOR

This LED warns of a problem in the system when illuminated. Reduce the LEVEL of the device which supplies signal to the amplifier or reduce the LEVEL control(s) on the amplifier. This LED should not be illuminated during normal operation.

### 4. PROTECTION INDICATOR

This LED warns of a problem in the system when illuminated. Reduce the volume and look for problems. It is possible that the amplifier is too hot or the speaker impedance is too low. This LED should not be illuminated during normal operation.

### 5. POWER INDICATOR

This LED indicates the amplifier is switched ON and receiving AC POWER when illuminated.

### 6. POWER SWITCH

The position of this switch determines whether the power is ON or OFF. The power-on status is confirmed by the power indicator. Amplifiers are always the last item in a system to be turned on. It is a good idea to turn down the level controls before applying AC mains power.

### 7. HANDLE

Handles are provided for moving and installing into equipment enclosures or racks.

## Rear Panel

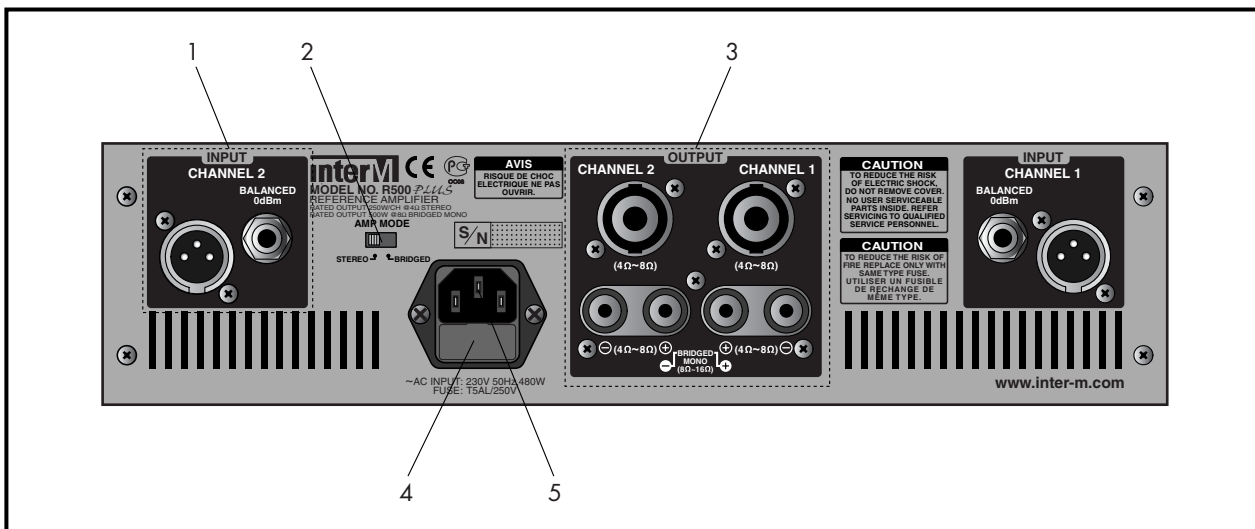

### 1. BALANCED INPUT CONNECTORS

Each input channel is equipped with a 1/4" TRS and an XLR connector. Standard rules of interconnect apply.

### 2. MODE SELECTOR SWITCH

Move this switch to select either the STEREO or BRIDGED MONO position as needed for the application.

The Stereo mode is most common. Channel 1 input feeds the channel 1 output. The channel 2 input feeds the channel 2 output.

The Bridge Mono mode combines both channels to create one larger mono channel. Input signal applied to channel 1 will be available across the positive terminals of Channel 1 and channel 2. Do not connect the channel 2 input or any of the negative outputs.

### 3. OUTPUT CONNECTORS

Binding Posts and Locking speaker connectors are provided. Bridged Mono operation requires a different method of connecting the cables than Stereo operation. Be sure that the amplifier is in the correct mode before connecting the speaker load.

### 4. FUSE

The fuse protects the amplifier by opening the circuit for the AC mains power in case of overload or malfunction. If the fuse opens, the amplifier (and the various other components in the system) should be checked for proper operation. If the fuse continues to open after verifying that the system is wired correctly and that an overload has not occurred, the amplifier should be checked for proper operation by a service technician.

### 5. AC INPUT

Connect this product to an appropriate AC power source using the supplied Universal AC Power Cord.



## Mounting in a Rack

If multiple high-power amplifiers are mounted in a rack with poor ventilation, the heat from the amplifiers will cause the interior of the rack (and the amplifiers) to become very hot, which may cause problems with amplifier performance. If amplifiers are mounted in a rack without an open rear, you should use special care to help ensure proper ventilation of the rack.

Here are suggestions to help keep the amplifiers properly ventilated:

1. Leave a space of at least 10 cm (4 inches) between the rear door of the rack and the rear panel of the amplifier.
2. Install a fan or blower in the rack to help cool the equipment.
3. Install blank (or vent) panels between amplifiers.

### Typical Rack with multiple amplifiers

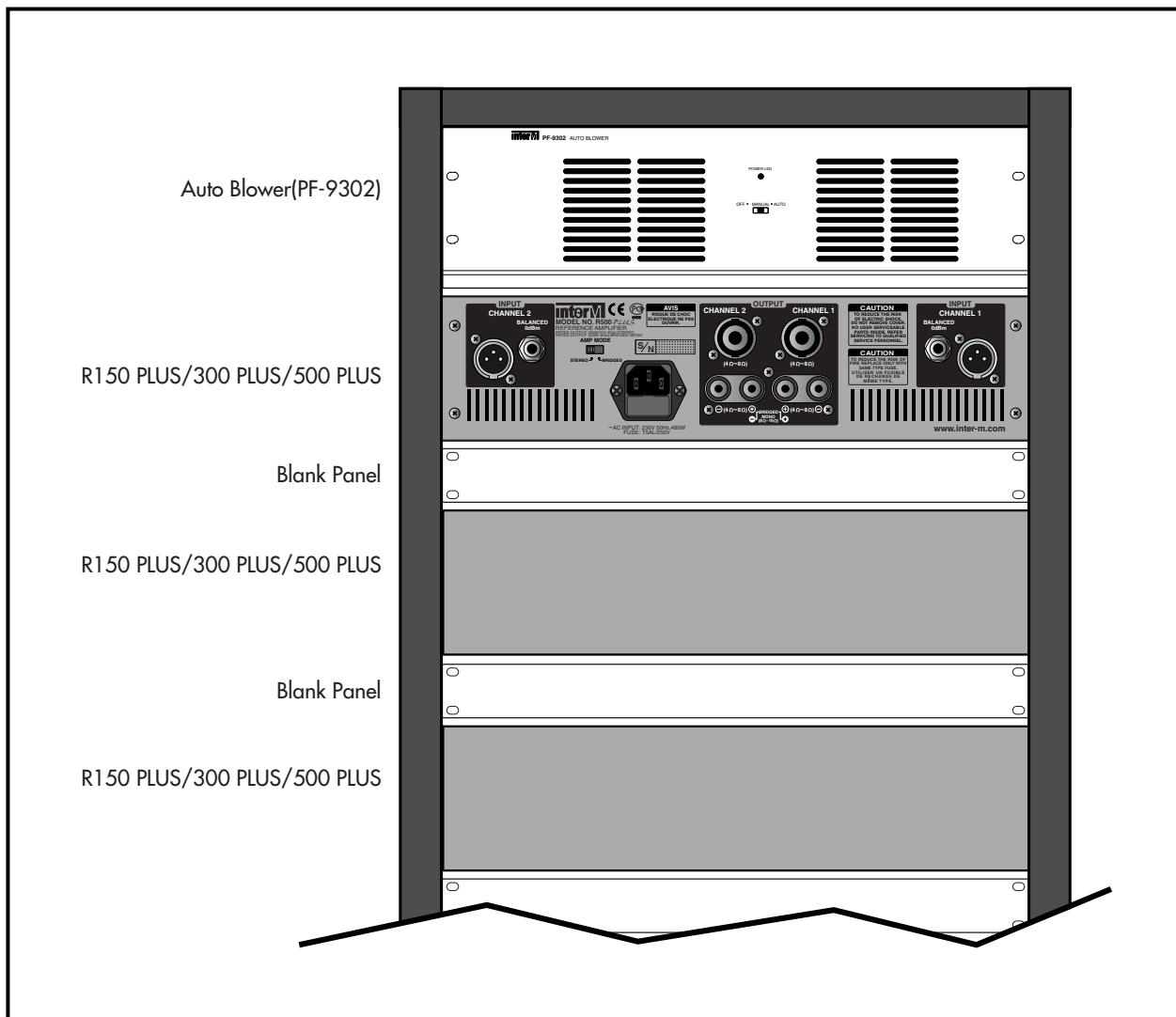

# Applications-1

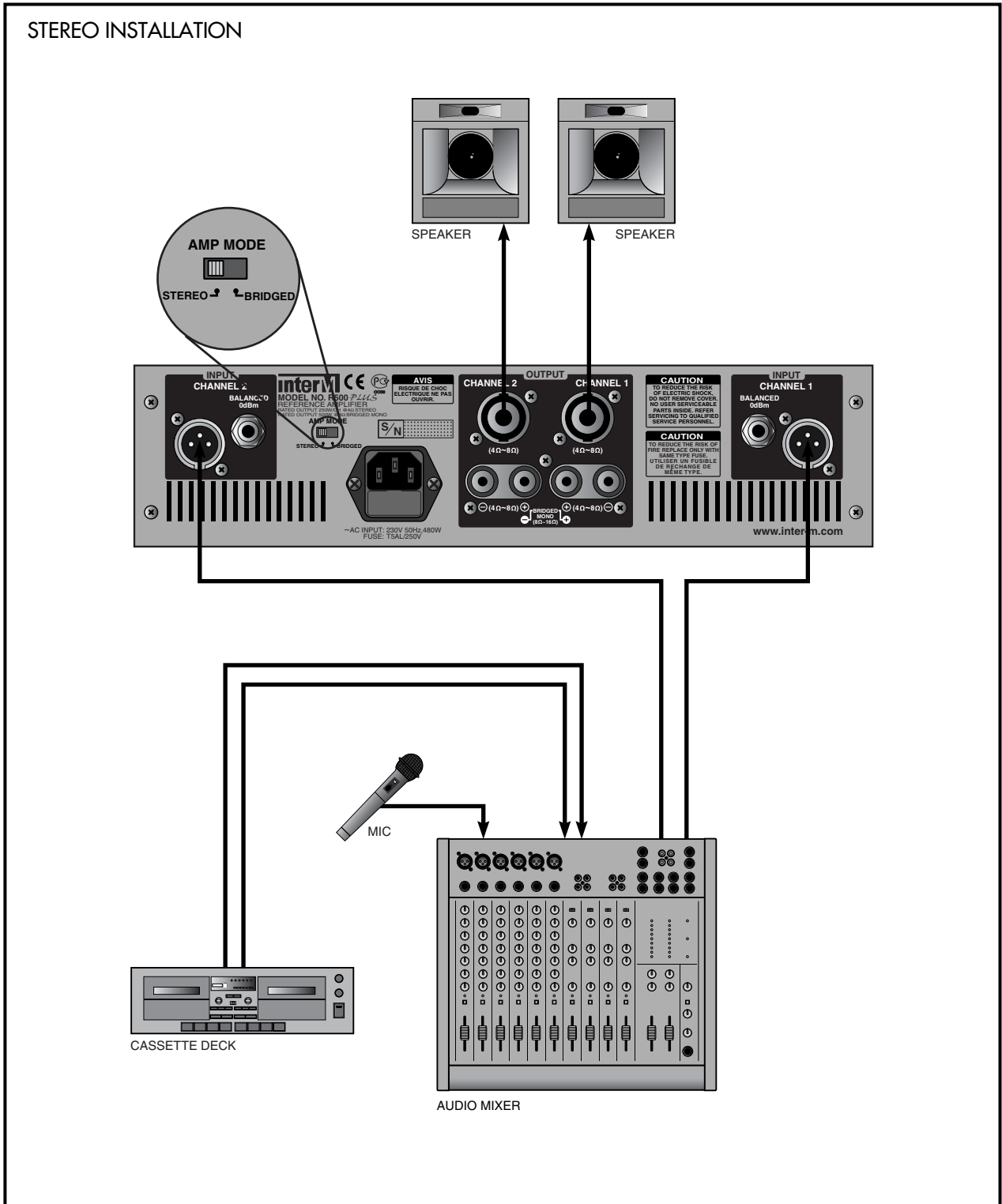

# Applications-2

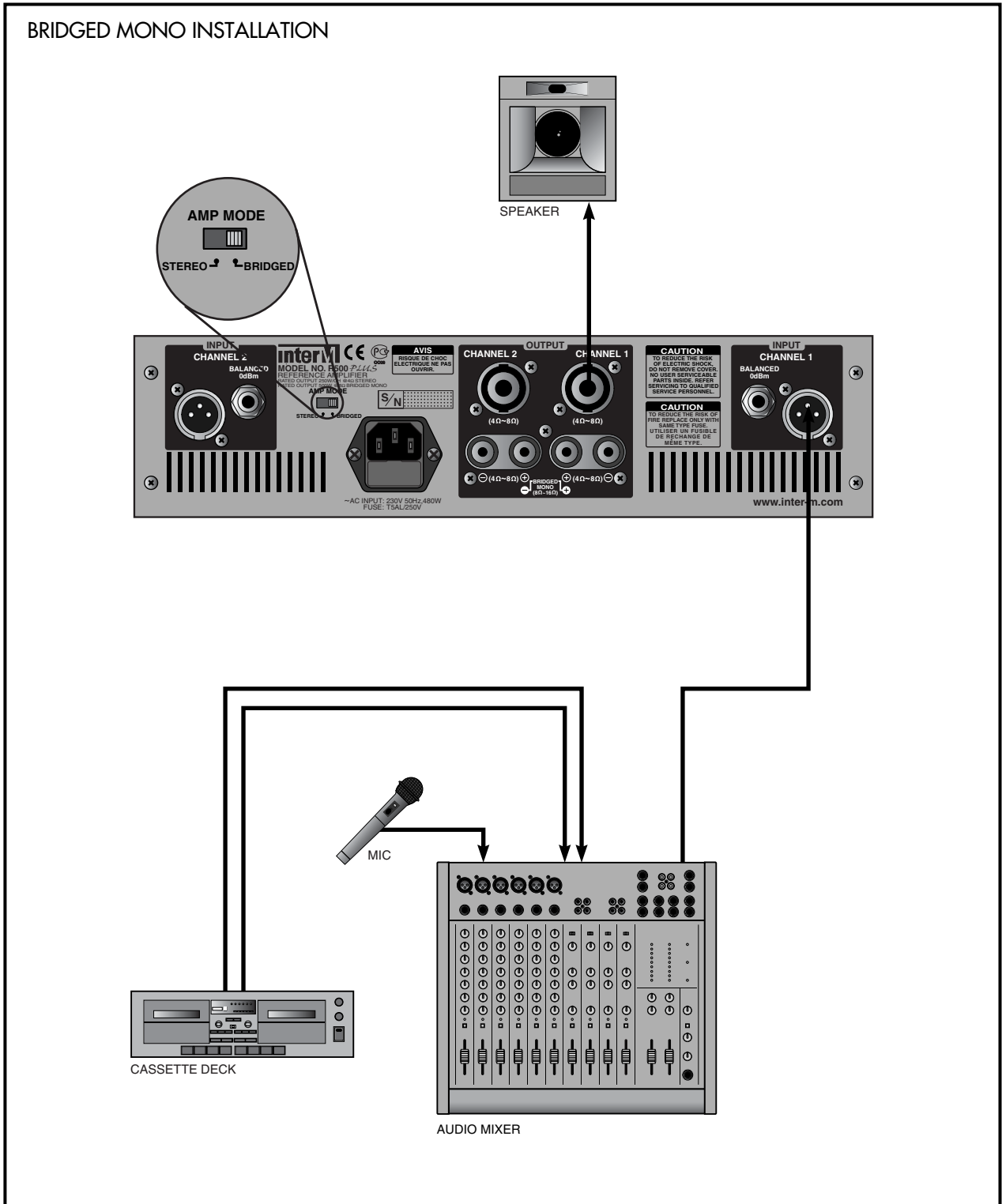

# Applications-3

## LINKED INSTALLATION

Linking works with stereo or bridged mono operation

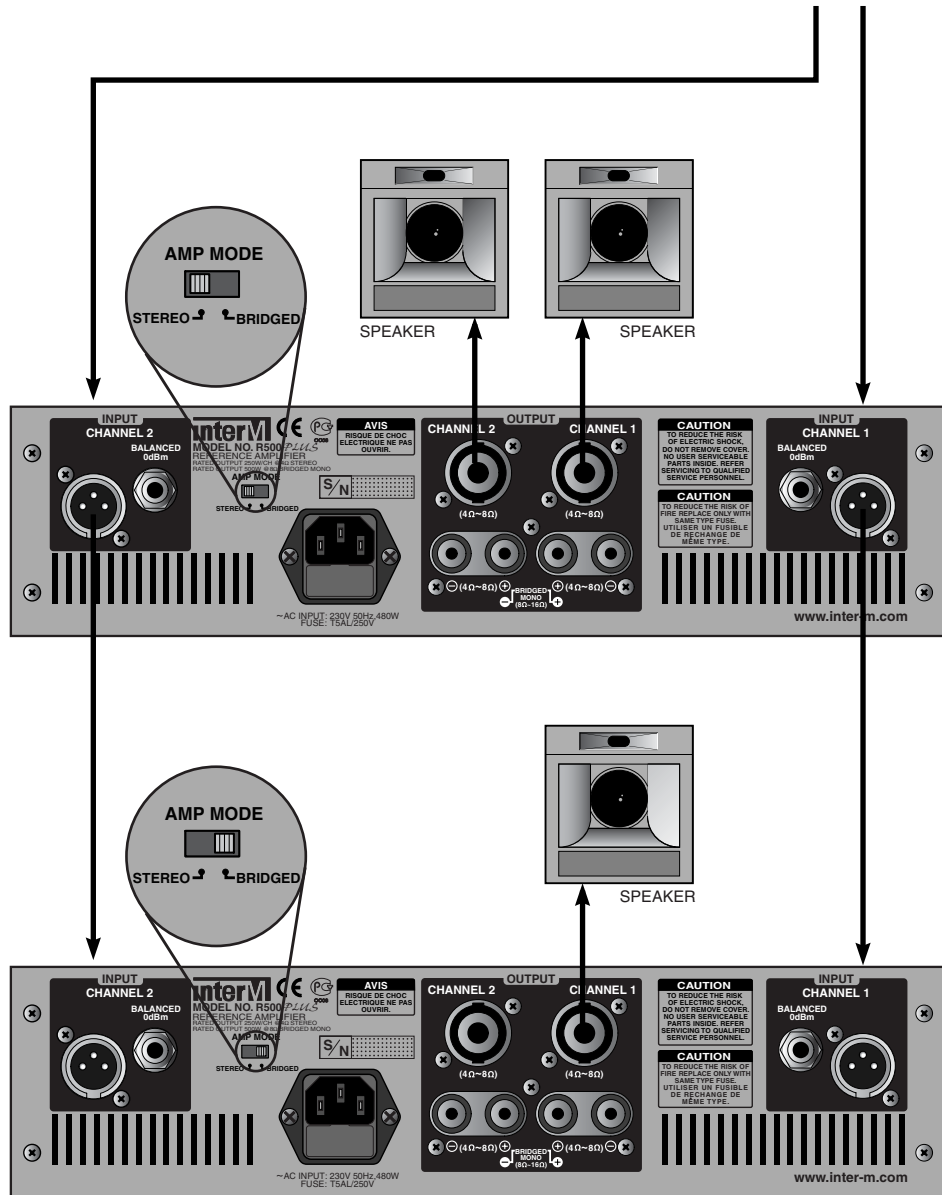

# Connections

Inter-M products are wired to reflect accepted wiring practices used throughout the world.

Balanced XLR connectors are wired as described:

- Pin #1 Shield
- Pin #2 Positive
- Pin #3 Negative

Balanced 1/4" TRS connectors are wired as described:

- Tip is Positive
- Ring is Negative
- Sleeve is Shield

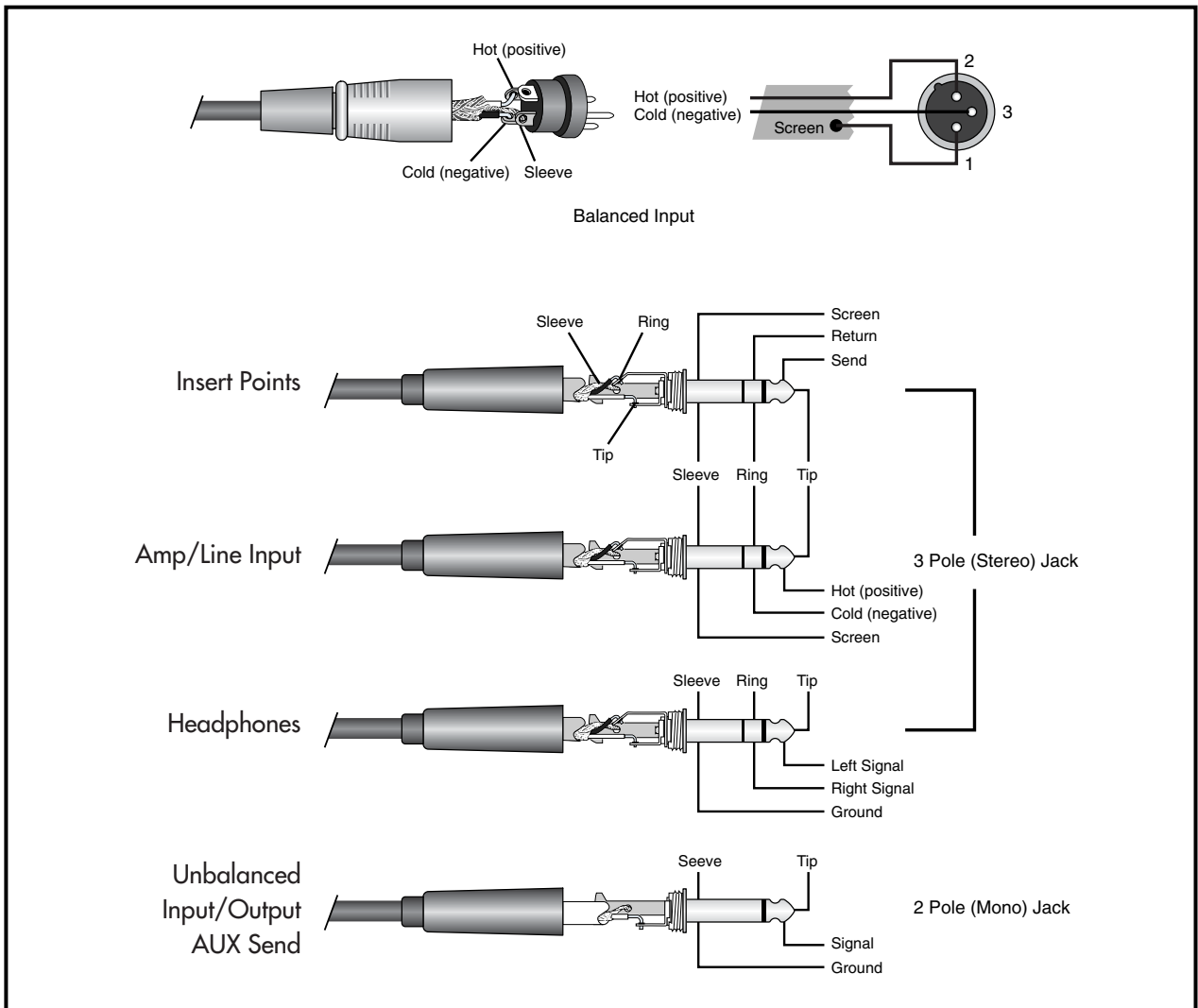

Stereo operation uses one positive and one negative terminal from the same channel.

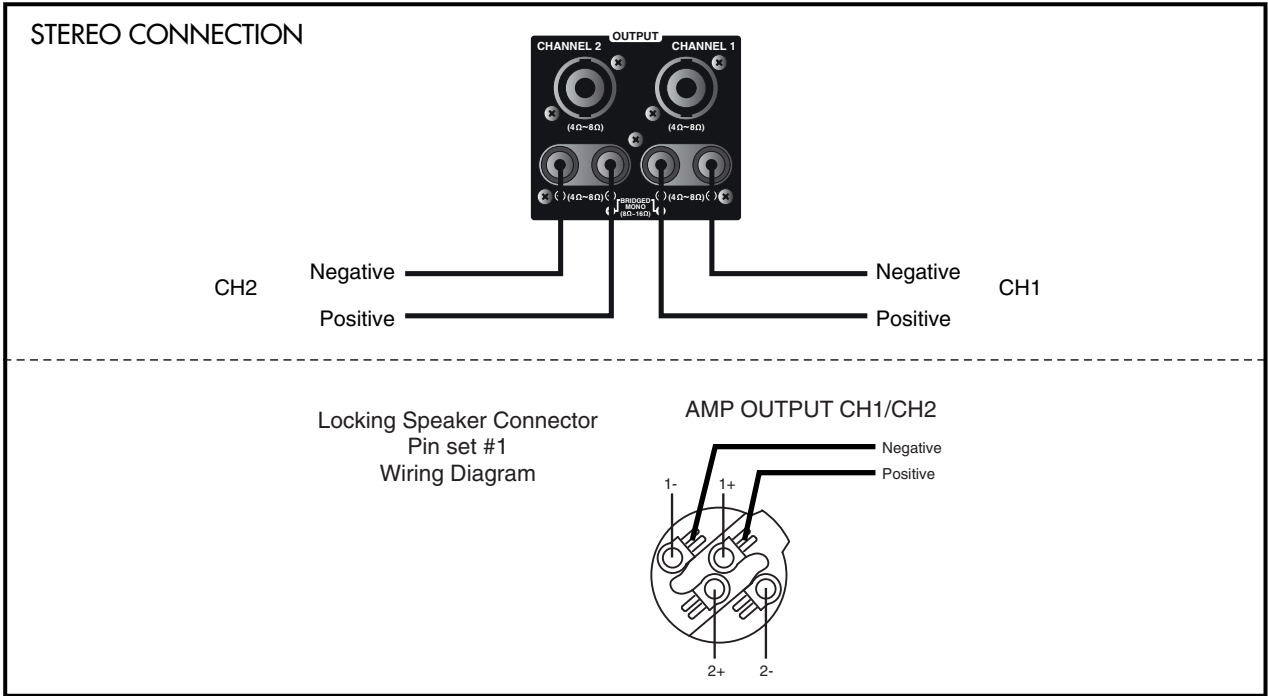

Bridged Mono uses the Positive terminals from both channels, the negative terminals have no connection. Bridged Mono operation has an impedance limitation of 8Ω.

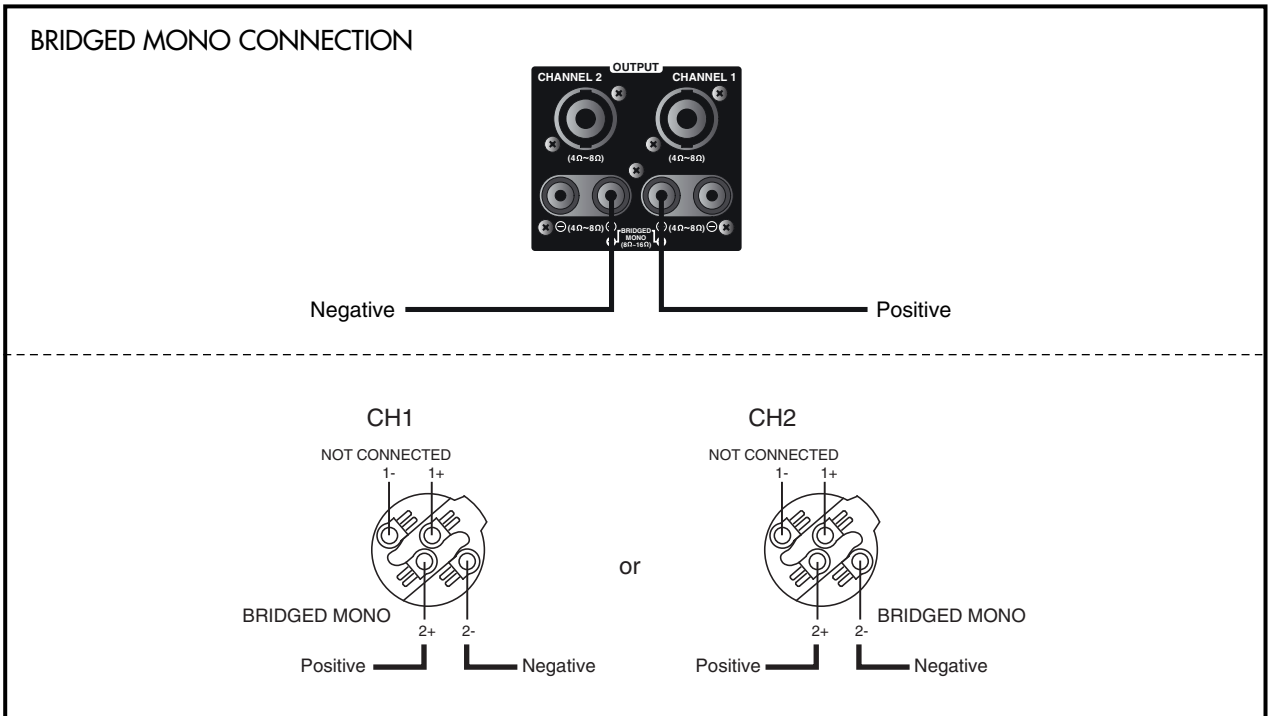

# Block Diagram

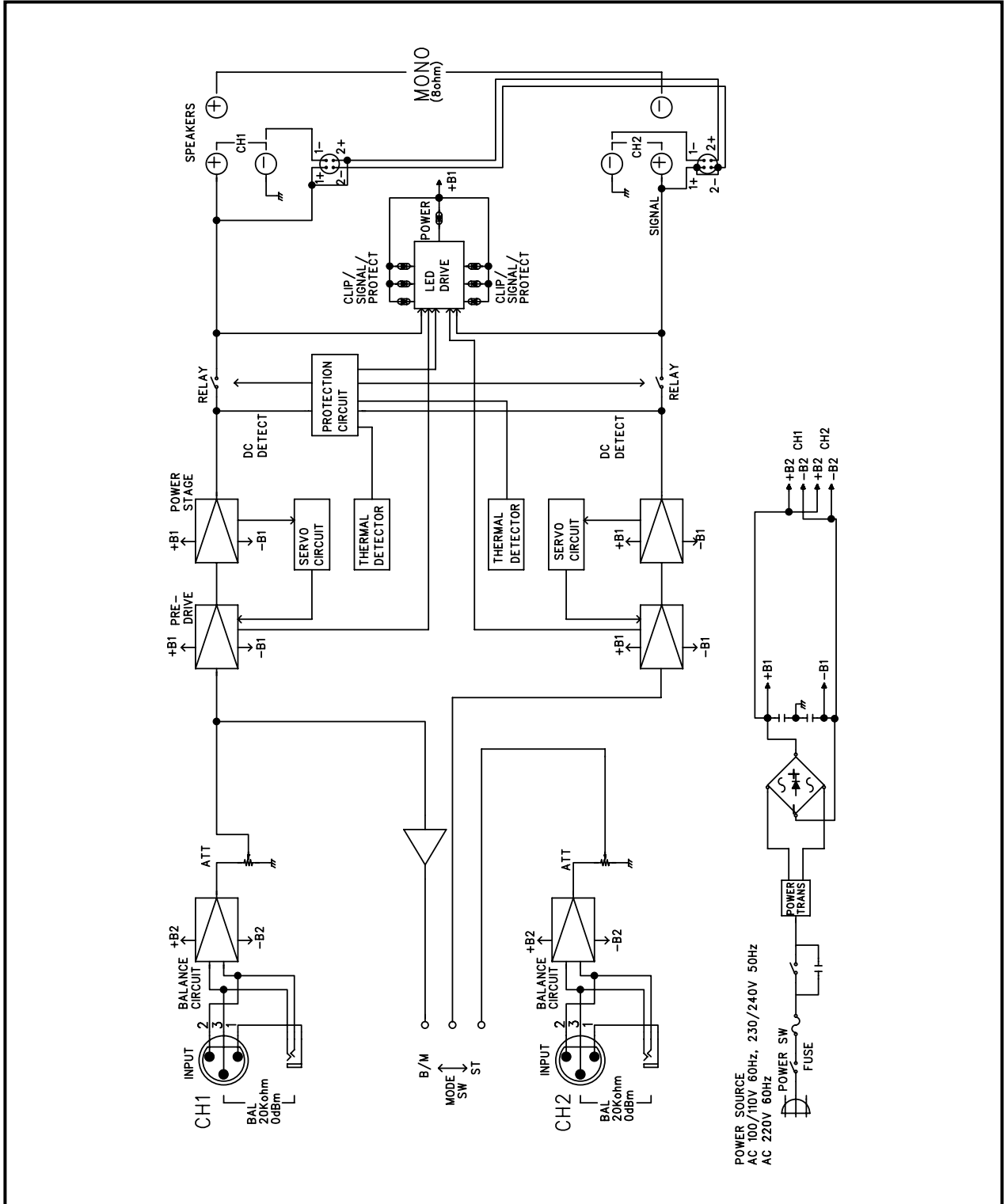

# Specifications

0dB=0.775 Vrms, Half Power=1/2 Power Output Level (Rated Power)

	R150 PLUS	R300 PLUS	R500 PLUS
Power Output Level			
STEREO	8Ω(T.H.D 0.5%) 4Ω(T.H.D 0.5%)	50W 75W	100W 150W
BRIDGED MONO	8Ω(T.H.D 0.05%) 8Ω(T.H.D 0.5%)	150W 170W	300W 330W
			170W 250W 460W 500W
Frequency Response	20Hz~20kHz(±0.5dB)		
T.H.D (20Hz~20kHz, half power)	≤0.1%		
Channel Separation (half power 8Ω)	≥70dB		
Residual Noise	≤-80dB		
Signal to Noise Ratio	≥100dB		
Input Sensitivity (rated power into 4Ω at 1kHz)	0dBm		
Indicators	Function	Color	
	Power	GREEN	
	Clip/Limiter	RED	
	Signal	GREEN	
	Protection	RED	
Protection	Power ON/OFF muting, short circuit and thermal		
Power Source	AC 100V/110V 60Hz, 230V/240V 50Hz		
Power Consumption	1.5A	2.4A	3.9A
Weight	7.2kg/15.9lb	8.4kg/18.5lb	10.4kg/22.9lb
Dimensions	482mm/19in(W) x 88mm/3.5in(H) x 317mm/12.5in(D)		

\* Specifications and design subject to change without notice.



## Service

### Procedures

Take steps to insure the problem is not related to operator error or other products within the system. Information provided in the troubleshooting portion of this manual may help with this process. Once it is certain that the problem is related to the product contact your warranty provider as described in the warranty section of this manual.

### Schematic

A Schematic is available by contacting your warranty provider.

### Parts List

A Parts List is available by contacting your warranty provider.

## Variations and Options

### Variations

Products supplied through legitimate sources are compatible with local AC power requirements.

### Options

No optional items are available for this product.

## Warranty

Warranty terms and conditions vary by country and may not be the same for all products. Terms and conditions of warranty for a given product may be determined first by locating the appropriate country which the product was purchased in, then by locating the product type.

To obtain specific warranty information and available service locations contact Inter-M directly or the authorized Inter-M Distributor for your specific country or region.



Inter-M, Ltd. (Korea) began operations in 1983.

Since then, Inter-M has grown to become one of the largest manufacturers of professional audio and commercial sound electronics equipment in the world.

Inter-M has gained worldwide recognition for its own branded products, as well as private label manufacturing of electronics sold under other names (OEM).

The company is no longer just a Korean company, but rather a global company that is truly international in scope, with factories and offices in Korea and China, and sales and marketing operations located in Japan, Europe, and the U.S.A.

With more than 850 employees around the globe, Inter-M is well-poised for further growth and expansion.

**INTER-M AMERICAS, INC.**

1 EAST BEACON LIGHT LANE CHESTER, PA USA 19013-4409

TEL : 1-610-874-8870, FAX : 1-610-874-8890

Home Page : <http://www.inter-m.net>, E-mail : [service@inter-m.net](mailto:service@inter-m.net)

**INTER-M Corporation**

SEOUL OFFICE: 653-5 BANGHAK-DONG, DOBONG-KU, SEOUL, KOREA

TEL : 82-2-2289-8140~8, FAX : 82-2-2289-8149

Home Page : <http://www.inter-m.com>, E-mail : [export@inter-m.com](mailto:export@inter-m.com)

MADE IN CHINA  
December 2005 9007300410 A