

# AIR CONDITIONING SYSTEMS

Models: V2MD I-12 / U2 MRS -12  
IMDH I-36 / UMLT-36  
LV2MD I-12

## Duct Unit **Owner's Manual**



Thank you for choosing INVENTOR air conditioning system. For correct use of this unit, please read this manual carefully and keep it for future reference.

**INDOOR UNIT**

**OUTDOOR UNIT**

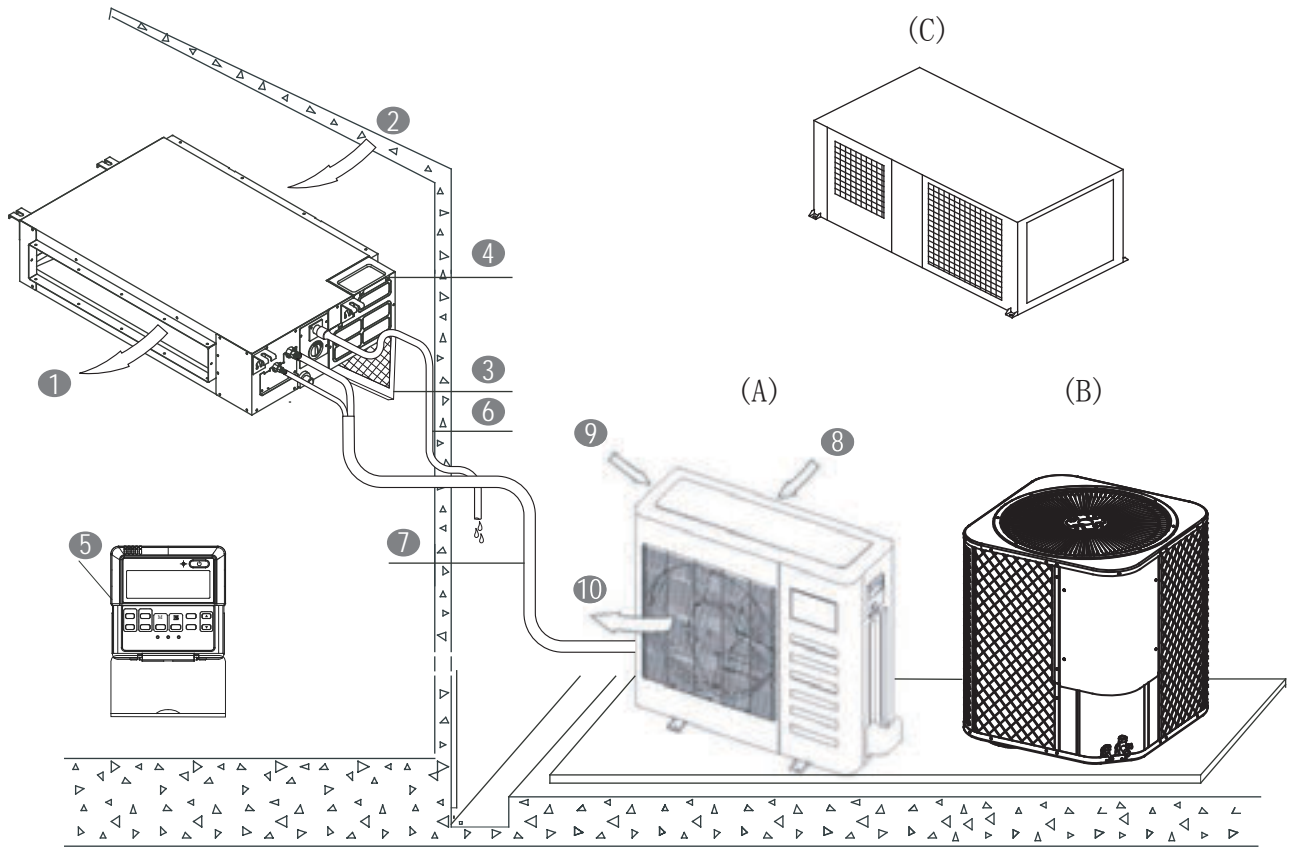

Fig.1

**INDOOR UNIT**

- ① Air outlet
- ② Air inlet
- ③ Air filter(on some models)
- ④ Electric control cabinet
- ⑤ Wire controller(on some models)
- ⑥ Drain pipe

**OUTDOOR UNIT(A,B,C)**

- ⑦ Connecting pipe
- ⑧ Air inlet
- ⑨ Air inlet(side and rear)
- ⑩ Air outlet



**NOTE**

All the pictures in this manual are for explanation purpose only. They may be slightly different from the air conditioner you purchased(depend on model).The actual shape shall prevail.

IMPORTANT SAFETY INFORMATION.....	1
PARTS NAMES.....	2
AIR CONDITIONER OPERATIONS AND PERFORMANCE.....	2
HINTS FOR ECONOMICAL OPERATION.....	3
MAINTENANCE.....	3
FOLLOWING SYMPTOMS ARE NOT AIR CONDITIONER TROUBLES.....	5
TROUBLESHOOTING.....	6

If used as MULTI unit, please refer to the Installation & operation manuals packed with outdoor unit.

## 1. IMPORTANT SAFETY INFORMATION

**To prevent injury to the user or other people and property damage, the following instructions must be followed. Incorrect operation due to ignoring of instructions may cause harm or damage.**

The safety precautions listed here are divided into two categories. In either case, important safety information is listed which must be read carefully.



### WARNING

The appliance shall be installed in accordance with national wiring regulations. Failure to observe a warning may result in death.



### CAUTION

Failure to observe a caution may result in injury or damage to the equipment.



### WARNING

**Ask your dealer for installation of the air conditioner.**  
Incomplete installation performed by yourself may result in a water leakage, electric shock, and fire.

**Ask your dealer for improvement, repair, and maintenance.**  
Incomplete improvement, repair, and maintenance may result in a water leakage, electric shock, and fire.

**In order to avoid electric shock, fire or injury, or if you detect any abnormality such as smell of fire, turn off the power supply and call your dealer for instructions.**

**Never let the indoor unit or the remote controller get wet.**  
It may cause an electric shock or a fire.

**Never press the button of the remote controller with a hard, pointed object.**  
The remote controller may be damaged.

**Never replace a fuse with that of wrong rated current or other wires when a fuse blows out.**  
Use of wire or copper wire may cause the unit to break down or cause a fire.

**It is not good for your health to expose your body to the air flow for a long time.**

**Do not insert fingers, rods or other objects into the air inlet or outlet.**  
When the fan is rotating at high speed, it will cause injury.

**Never use a flammable spray such as hair spray, lacquer or paint near the unit.**  
It may cause a fire.

**Never touch the air outlet or the horizontal blades while the swing flap is in operation.**  
Fingers may become caught or the unit may break down.

**Never put any objects into the air inlet or outlet.**  
Objects touching the fan at high speed can be dangerous.

**Never inspect or service the unit by yourself.**  
Ask a qualified service person to perform this work.

**Do not dispose this product as unsorted municipal waste. Collection of such waste separately for special treatment is necessary.**

Do not dispose of electrical appliances as unsorted municipal waste, use separate collection facilities.  
Contact your local government for information regarding the connection systems available.

**If electrical appliances are disposed of in landfills or dumps, hazardous substances can leak into the ground and get into the food chain, damaging your health and well-being**

**To prevent refrigerant leak, contact your dealer.**  
When the system is installed and runs in a small room, it is required to keep the concentration of the refrigerant, if by any chance coming out, below the limit. Otherwise, oxygen in the room may be affected, resulting in a serious accident.

**The refrigerant in the air conditioner is safe and normally does not leak.**  
If the refrigerant leaks in the room, contact with a fire of a burner, a heater or a cooker may result in a harmful gas.

**Turn off any combustible heating devices, ventilate the room, and contact the dealer where you purchased the unit.**  
Do not use the air conditioner until a service person confirms that the portion where the refrigerant leaks is repaired.



### CAUTION

**Do not use the air conditioner for other purposes.**  
In order to avoid any quality deterioration, do not use the unit for cooling precision instruments, food, plants, animals or works of art.

**Before cleaning, be sure to stop the operation, turn the breaker off or pull out the supply cord.**  
Otherwise, an electric shock and injury may result.

**In order to avoid electric shock or fire, make sure that an earth leak detector is installed.**

**Be sure the air conditioner is grounded.**  
In order to avoid electric shock, make sure that the unit is grounded and that the earth wire is not connected to gas or water pipe, lightning conductor or telephone earth wire.

**In order to avoid injury, do not remove the fan guard of the outdoor unit.**

**Do not operate the air conditioner with a wet hand.**  
An electric shock may happen.

**Do not touch the heat exchanger fins.**  
These fins are sharp and could result in cutting injuries.

**Do not place items which might be damaged by moisture under the indoor unit.**  
Condensation may form if the humidity is above 80%, the drain outlet is blocked or the filter is polluted.

**After a long use, check the unit stand and fitting for damage.**  
If damaged, the unit may fall and result in injury.

**To avoid oxygen deficiency, ventilate the room sufficiently if equipment with burner is used together with the air conditioner.**

**Arrange the drain hose to ensure smooth drainage.**  
Incomplete drainage may cause wetting of the building, furniture etc.

**Never touch the internal parts of the controller.**  
Do not remove the front panel. Some parts inside are dangerous to touch, and a machine trouble may happen.

**Never expose little children, plants or animals directly to the air flow.**  
Adverse influence to little children, animals and plants may result.

**Do not allow a child to mount on the outdoor unit or avoid placing any object on it.**  
Falling or tumbling may result in injury.

**Do not operate the air conditioner when using a room fumigation - type insecticide.**  
Failure to observe could cause the chemicals to become deposited in the unit, which could endanger the health of those who are hypersensitive to chemicals.

**Do not place appliances which produce open fire in places exposed to the air flow from the unit or under the indoor unit.**  
It may cause incomplete combustion or deformation of the unit due to the heat.

**Do not install the air conditioner at any place where flammable gas may leak out.**  
If the gas leaks out and stays around the air conditioner, a fire may break out.

**The appliance is not intended for use by young children or infirm persons without supervision.**

**Young children should be supervised to ensure that they do not play with the appliance.**

This appliance can be used by children aged from 8 years and above and persons with reduced physical, sensory or mental capabilities or lack of experience and knowledge if they have been given supervision or instruction concerning use of the appliance in a safe way and understand the hazards involved. Children shall not play with the appliance. Cleaning and user maintenance shall not be made by children without supervision.

This appliance is not intended for use by persons (including children) with reduced physical, sensory or mental capabilities, or lack of experience and knowledge, unless they have been given supervision or

instruction concerning use of the appliance by a person responsible for their safety.

Children should be supervised to ensure that they do not play with the appliance.

If the supply cord is damaged, it must be replaced by the manufacturer, its service agent or similarly qualified persons in order to avoid a hazard.

Do not operate your air conditioner in a wet room such as a bathroom or laundry room.

## 2. PARTS NAMES

**The air conditioner consists of the indoor unit, the outdoor unit, the connecting pipe and the remote controller.**  
(Refer to Fig.2-1)

### Function indicators on indoor unit display panel

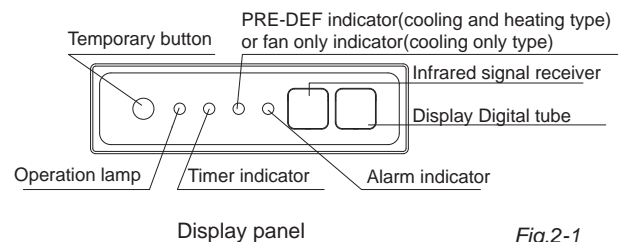

Fig.2-1

This function is used to operate the unit temporarily in case you misplace the remote controller or its batteries are exhausted. Two modes including AUTO and FORCED COOL can be selected through the TEMPORARY BUTTON on the air-in grill control box of the indoor unit. Once you push this button, the air conditioner will run in such order: AUTO, FORCED COOL, OFF, and back to AUTO.

- 1 AUTO**  
The OPERATION lamp is lit, and the air conditioner will run under AUTO mode. The remote controller operation is enabled to operate according to the received signal.
- 2 FORCED COOL**  
The OPERATION lamp flashes, the air conditioner will turn to AUTO after it is enforced to cool with a wind speed of HIGH for 30 minutes. The remote controller operation is disabled.
- 3 OFF**  
The OPERATION lamp goes off. The air conditioner is OFF while the remote controller operation is enabled.



### NOTE

This manual does not include Remote Controller Operations, see the <<Remote Controller Owner's manual>> packed with the unit for details.

### 3. AIR CONDITIONER OPERATIONS AND PERFORMANCE

Use the system in the following temperature for safe and effective operation. The Max operation temperature for the air conditioner. (Cooling/Heating)

Table 2-1

Mode \ Temperature	Outdoor temperature	Room temperature
Cooling operation	18°C ~ 43°C / 64 °F~109°F	17°C ~ 32°C (62 °F ~ 90°F)
	-7°C ~ 43°C / 20 °F~109°F (for the models with low temperature cooling system)	
	18°C ~ 52°C / 64 °F~126°F (for special tropical models)	
Heating operation (cooling only type without)	-7°C ~ 24°C / 20 °F ~ 76°F	0°C ~ 30°C / 32 °F~86°F
Dry operation	18°C ~ 43°C / 64 °F~109°F	17°C ~ 32°C (62 °F ~ 90°F)
	18°C ~ 52°C / 64 °F~126°F (for special tropical models)	

Table 2-2(for inverter type air conditioner)

Mode \ Temperature	Outdoor temperature	Room temperature
Cooling operation	0°C ~ 50°C / 32 °F~122°F	17°C ~ 32°C (62 °F ~ 90°F)
	-15°C ~ 50°C / 5 °F~122°F (for the models with low temperature cooling system)	
Heating operation (cooling only type without)	-15°C ~ 24°C / 5 °F~76°F	0°C ~ 30°C / 32 °F~86°F
Dry operation	0°C ~ 50°C / 32 °F~122°F	17°C ~ 32°C (62 °F ~ 90°F)



#### NOTE

- 1 If air conditioner is used outside the above conditions, it may cause the unit to function abnormally.
- 2 The phenomenon is normal that the surface of air conditioning may condense water when the relative larger humidity in room, please close the door and window.
- 3 Optimum performance will be achieved within these operating temperature range.

#### Three-minute protection feature

A protection feature prevents the air conditioner from being activated for approximately 3 minutes when it restarts immediately after operation.

#### Power failure

Power failure during operation will stop the unit completely.

- The OPERATION lamp on the indoor unit will start flashing when power is restored.
- To restart operation, push the ON/OFF button on the remote controller.
- Lightning or a car wireless telephone operating nearby may cause the unit to malfunction.

### 4. HINTS FOR ECONOMICAL OPERATION

The following should be noticed to ensure an economical operation. (Refer to corresponding chapter for details)

- Adjust the air flow direction properly to avoid winding toward your body.
- Adjust the room temperature properly to get a comfortable situation and to avoid supercooling and superheat.
- In cooling, close the curtains to avoid direct sunlight.
- To keep cool or warm air in the room, never open doors or windows more often than necessary.
- Set the timer for the desired operating time.
- Never put obstructions near the air outlet or the air inlet. Or it will cause lower efficiency, even a sudden stop.
- Adjust the air flow direction properly to avoid winding toward your body.
- Adjust the room temperature properly to get a comfortable situation and to avoid supercooling and superheat.
- In cooling, close the curtains to avoid direct sunlight.
- To keep cool or warm air in the room, never open doors or windows more often than necessary.
- If you don't plan to use the unit for a long time, please disconnect power and remove the batteries from the remote controller. When the power switch is connected, some energy will be consumed, even if the air conditioner isn't in operation. So please disconnect the power to save energy. And please switch the power on 12 hours before you restart the unit to ensure a smooth operation.
- A clogged air filter will reduce cooling or heating efficiency, please clean it once two weeks.

### 5. MAINTENANCE



#### CAUTION

**Before you clean the air conditioner, be sure the power supply is off.**

**Check if the wiring is not broken off or disconnected.**

**Use a dry cloth to wipe the indoor unit and remote controller.**

**A wet cloth may be used to clean the indoor unit if it is very dirty.**

**Never use a damp cloth on the remote controller.**

Do not use a chemically-treated duster for wiping or leave such material on the unit for long. it may damage or fade the surface of the unit.

Do not use benzine, thinner, polishing powder, or similar solvents for cleaning. These may cause the plastic surface to crack or deform.

■ **Maintenance after a long stop period**

(eg. at the beginning of the season)

Check and remove everything that might be blocking inlet and outlet vents of indoor units and outdoor units.

Clean air filters and casings of indoor units. Refer to "Cleaning the air filter" for details on how to proceed and make sure to install cleaned air filters back in the same position.

Check and remove everything that might be blocking inlet and outlet vents of indoor units and outdoor units.

Clean air filters and casings of indoor units. Refer to "Cleaning the air filter" for details on how to proceed and make sure to install cleaned air filters back in the same position.

Turn on the power at least 12 hours before operating the unit in order to ensure smoother operation. As soon as the power is turned on, the remote controller displays appear.

■ **Maintenance before a long stop period**

(eg. at the end of the season)

Let the indoor units run in fan only operation for about half a day in order to dry the interior of the units.

Clean air filters and casings of indoor units. Refer to "Cleaning the air filter" for details on how to proceed and make sure to install cleaned air filters back in the same position.

■ **Cleaning the air filter(on some models)**

The air filter can prevent the dust or other particulate from going inside. In case of blockage of the filter, the working efficiency of the air conditioner may greatly decrease. Therefore, the filter must be cleaned once two weeks during long time usage.

If the air conditioner is installed in a dust place, clean the the air filter frequent.

If the accumulated dust is too heavy to be cleaned, please replace the filter with a new one(replaceable air filter is an optional fitting).

- For your purchasing unit is a rear ventilated one, please remove the filter fixed screws (2 screws) and take down the filter away from the unit.

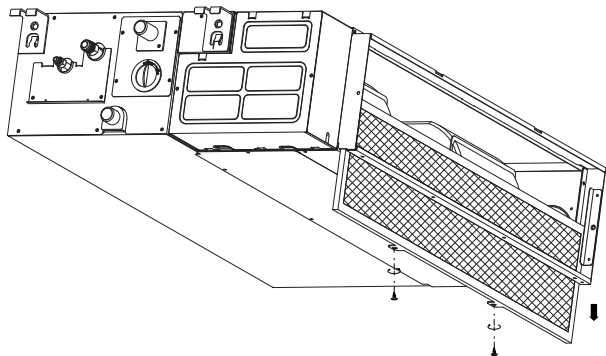

Fig.5-1

- For your purchasing unit is a descensional ventilated one, please push the filter up slightly to let the position retainer escape away from the flange fixed holes, and take off the filter according to the arrow direction shows in the following fig.

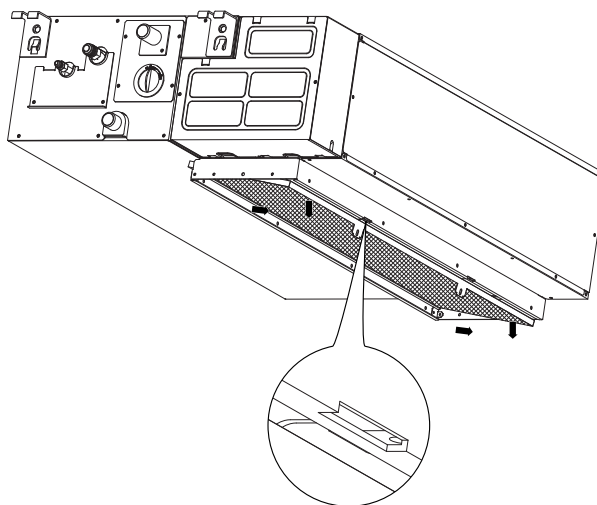

Fig.5-2

- Clean the air filter (Vacuum cleaner or pure water may be used to clean the air filter. If the dust accumulation is too heavy, please use soft brush and mild detergent to clean it and dry out in cool place).

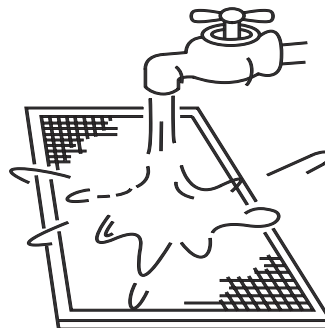

Fig.5-3

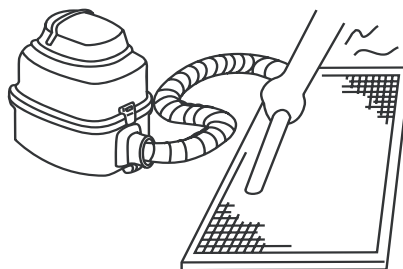

Fig.5-4

The air-in side should face up when using vacuum cleaner.

(Refer to Fig.5-4)

The air-in side should face down when using water. (Refer to Fig.5-3)



## CAUTION

Do not dry out the air filter under direct sunshine or with fire.

5. Re-install the air filter

6. Install and close the air-in grill in the reverse order of step 1 and 2 and connect the control box cables to the corresponding terminators of the main body .

## 6. FOLLOWING SYMPTOMS ARE NOT AIR CONDITIONER TROUBLES

### Symptom 1: The system does not operate

- The air conditioner does not start immediately after the ON/OFF button on the remote controller is pressed.  
If the operation lamp lights, the system is in normal condition. To prevent overloading of the compressor motor, the air conditioner starts 3 minutes after it is turned ON.
- If the operation lamp and the "PRE-DEF indicator (cooling and heating type) or fan only indicator (cooling only type)" light, it means you choose the heating model. When just starting, if the compressor has not started, the indoor unit appears "anti cold wind" protection because of its overflow outlet temperature.

### Symptom 2: Change into the fan mode during cooling mode

- In order to prevent the indoor evaporator frosting, the system will change into fan mode automatically, restore to the cooling mode after soon.
- When the room temperature drops to the set temperature, the compressor goes off and the indoor unit changes to fan mode; when the temperature rises up, the compressor starts again. It is same in the heating mode.

### Symptom 3: White mist comes out of a unit

#### Symptom 3.1: Indoor unit

- When humidity is high during cooling operation. If the interior of an indoor unit is extremely contaminated, the temperature distribution inside a room becomes uneven. It is necessary to clean the interior of the indoor unit. Ask your dealer for details on cleaning the unit. This operation requires a qualified service person.

### Symptom 3.2: Indoor unit, outdoor unit

- When the system is changed over to heating operation after defrost operation. Moisture generated by defrost becomes steam and is exhausted.

## Sptom 4: Noise of air conditioners cooling

### Symptom 4.1: Indoor unit

- A continuous low "shah" sound is heard when the system is in cooling operation or at a stop.  
When the drain pump (optional accessories) is in operation, this noise is heard.
- A "pishi-pishi" squeaking sound is heard when the system stops after heating operation.  
Expansion and contraction of plastic parts caused by temperature change make this noise.

### Symptom 4.2: Indoor unit, outdoor unit

- A continuous low hissing sound is heard when the system is in operation.  
This is the sound of refrigerant gas flowing through both indoor and outdoor units.
- A hissing sound which is heard at the start or immediately after stopping operation or defrost operation.  
This is the noise of refrigerant caused by flow stop or flow change.

### Symptom 4.3: Outdoor unit

- When the tone of operating noise changes.  
This noise is caused by the change of frequency.

## Symptom 5: Dust comes out of the unit

- When the unit is used for the first time in a long time.  
This is because dust has gotten into the unit.

## Symptom 6: The units can give off odours

- The unit can absorb the smell of rooms, furniture, cigarettes, etc., and then emit it again.

## Symptom 7: The outdoor unit fan does not spin.

- During operation. The speed of the fan is controlled in order to optimize product operation.

## 7. TROUBLESHOOTING

### 7.1. Troubles and causes of air conditioner

If one of the following malfunctions occur, stop operation, shut off the power, and contact with your dealer.

- The operation lamp is flashing rapidly (5Hz). This lamp is still flashing rapidly after turn off the power and turn on again. (Refer to Table 7-1a, Table 7-1b and Table 7-2)
- Remote controller receives malfunction or the button does not work well.
- A safety device such as a fuse, a breaker frequently actuates.
- Obstacles and water enter the unit.
- Water leaks from indoor unit.
- Other malfunctions.

If the system does not properly operate except the above mentioned cases or the above mentioned malfunctions is evident, investigate the system according to the following procedures. (Refer to Table 7-3)



#### CAUTION

































---

Please cut off the power supply when appearing the above malfunction, check if the voltage provided is out of range, check if the installation of air-conditioner is correct, then electrify again after 3 minutes power off. If the problem is still existent, please contact the local service station or the equipment provider.

---





Table 7-1a

NO.	MALFUNCTION & PROTECTION DEFINE	LED1 OPERATION	LED2 TIMER	LED3 DEF.FAN	LED4 ALARM	DISPLAY DIGITAL TUBE
1	Room temperature sensor checking channel is abnormal					E0
2	Pipe temperature sensor checking channel is abnormal					E1
3	In-Outdoor unit COMM. checking channel is abnormal					E2
4	Water-level alarm malfunction					E3
5	EEPROM malfunction					E4
6	Module malfunction					E5
7	Outdoor sensor error or outdoor 807 EEPROM malfunction					E6
8	Outdoor fan motor speed out of control					E7
9	Indoor fan motor speed out of control					F5
10	Outdoor voltage protection					P0
11	Compressor top temperature protection					P1
12	Outdoor current system protection					P2
13	Compressor location protection					P4
14	Mode conflict					P5
		 Light	 Flashing at 2.5HZ	 Flashing at 0.5HZ		

**Applicable to inverter air conditioner only**

Table 7-1b

• • •	MALFUNCTION & PROTECTION DEFINE	LED1 OPERATION	LED2 TIMER	LED3 DEF.FAN	LED4 ALARM	DISPLAY DIGITAL TUBE
•	Room temperature sensor checking channel is abnormal		⊙			E2
•	Pipe temperature sensor checking channel is abnormal	⊙				E3
•	Outdoor TEMP. sensor checking channel is abnormal			⊙		E4
•	Outdoor malfunction	⊙	⊙	⊙	⊙	E6
•	Pump temperature sensor malfunction				⊙	E5
•	EEPROM malfunction	⊙	⊙			E7
•	Water-level alarm malfunction				⊙	E8
 Light		 Flashing at 5HZ		 Flashing at 1HZ		

**Applicable to fixed-frequency air conditioner only**

Table 7-2

Symptoms	Causes	Solution
<b>Unit does not start</b>	<ul style="list-style-type: none"> <li>Power failure.</li> <li>Power switch is off.</li> <li>Fuse of power switch may have burned.</li> <li>Batteries of remote controller exhausted or other problem of controller.</li> </ul>	<ul style="list-style-type: none"> <li>Wait for the comeback of power.</li> <li>Switch on the power.</li> <li>Replace the fuse.</li> <li>Replace the batteries or check the controller.</li> </ul>
<b>Air flowing normally but completely can't cooling</b>	<ul style="list-style-type: none"> <li>Temperature is not set correctly.</li> <li>Be in 3 minutes protection of compressor.</li> </ul>	<ul style="list-style-type: none"> <li>Set the temperature properly.</li> <li>Wait.</li> </ul>
<b>Units start or stop frequently</b>	<ul style="list-style-type: none"> <li>Refrigerant is too little or too much.</li> <li>Air or no concreting gas in the refrigerating circuit.</li> <li>Compressor is malfunction.</li> <li>Voltage is too high or too low.</li> <li>System circuit is blocked.</li> </ul>	<ul style="list-style-type: none"> <li>Check leakage, and rightly recharge refrigerant.</li> <li>Vacuum and recharge refrigerant.</li> <li>Maintenance or change compressor.</li> <li>Install manostat.</li> <li>Find reasons and solution.</li> </ul>
<b>Low cooling effect</b>	<ul style="list-style-type: none"> <li>Outdoor unit and indoor unit heat exchanger is dirty.</li> <li>The air filter is dirty.</li> <li>Inlet/outlet of indoor/outdoor units is blocked.</li> <li>Doors and windows are open</li> <li>Sunlight directly shine.</li> <li>Too much heat resource.</li> <li>Outdoor temp. is too high.</li> <li>Leakage of refrigerant or lack of refrigerant.</li> </ul>	<ul style="list-style-type: none"> <li>Clean the heat exchanger.</li> <li>Clean the air filter.</li> <li>Eliminate all dirties and make air smooth.</li> <li>Close doors and windows.</li> <li>Make curtains in order to shelter from sunshine.</li> <li>Reduce heat source.</li> <li>AC cooling capacity reduces (normal).</li> <li>Check leakage and rightly recharge refrigerant.</li> </ul>
<b>Low heating effect</b>	<ul style="list-style-type: none"> <li>Outdoor temperature is lower than 7°C</li> <li>Doors and windows not completely closed.</li> <li>Leakage of refrigerant or lack of refrigerant.</li> </ul>	<ul style="list-style-type: none"> <li>Use heating device.</li> <li>Close doors and windows.</li> <li>Check leakage and rightly recharge refrigerant.</li> </ul>

## 7.2. Troubles and causes of wire controller

Before asking for serving or repairing , check the following points. (Refer to Table 7-3)

Table 7-3

Symptoms	Solution	Causes
The fan speed can not be changed.	<ul style="list-style-type: none"> <li>● Check whether the MODE indicated on the display is "AUTO"</li> </ul>	When the automatic mode is selected, the air conditioner will automatically change the fan speed.
	<ul style="list-style-type: none"> <li>● Check whether the MODE indicated on the display is "DRY"</li> </ul>	When dry operation is selected, the air conditioner automatically change the fan speed. The fan speed can be selected during "COOL" , "FAN ONLY" , and "HEAT"
The wire controller signal is not transmitted even when the ON/OFF button is pushed.	<ul style="list-style-type: none"> <li>● Check whether the signal transmitter of the wire controller is properly directed to the infrared signal receiver of the indoor unit.</li> </ul>	The power supply is off.
The TEMP. indicator does not come on.	<ul style="list-style-type: none"> <li>● Check whether the MODE indicated on the display is FAN ONLY</li> </ul>	The temperature cannot be set during FAN mode.
The indication on the display disappears after a lapse of time.	<ul style="list-style-type: none"> <li>● Check whether the timer operation has come to an end when the TIMER OFF is indicated on the display.</li> </ul>	The air conditioner operation will stop up to the set time
The TIMER ON indicator goes off after a lapse of certain time.	<ul style="list-style-type: none"> <li>● Check whether the timer operation is started when the TIMER ON is indicated on the display.</li> </ul>	Up to the set time, the air conditioner will automatically start and the appropriate indicator will go off.
No receiving tone sounds from the indoor unit even when the ON/OFF button is pressed.	<ul style="list-style-type: none"> <li>● Check whether the signal transmitter of the wire controller is properly directed to the infrared signal receiver of the indoor unit when the ON/OFF button is pressed.</li> </ul>	Directly transmit the signal transmitter of the wire controller to the infrared signal receiver of the indoor unit, and then repeatedly push the ON/OFF button twice.

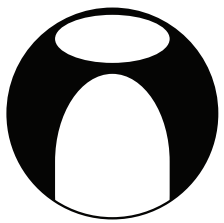

**inventor**<sup>®</sup>

Your-conditions