

Viral RNA and DNA isolation

User manual

NucleoSpin[®] 8 Virus

NucleoSpin[®] 8 Virus Core Kit

April 2014 / Rev. 05

MACHEREY-NAGEL

www.mn-net.com



Table of contents

1	Components	4
1.1	Kit contents	4
1.2	Reagent to be supplied by user	5
2	Product description	6
2.1	The basic principle	6
2.2	Kit specifications	7
2.3	Required hardware	8
2.4	Recommended accessories for use of the NucleoSpin® 8 Virus Core Kit	8
2.5	Automated processing on robotic platforms	10
2.6	Sample material	11
2.7	Carrier RNA	12
2.8	Elution procedures	12
3	Storage conditions and preparation of working solutions	13
4	Safety instructions	15
5	Protocols	17
5.1	NucleoSpin® 8 Virus – centrifuge processing	17
5.2	NucleoSpin® 8 Virus (Core Kit) – vacuum processing	22
6	Appendix	29
6.1	Troubleshooting	29
6.2	Ordering information	30
6.3	Product use restriction/warranty	31

1 Components

1.1 Kit contents

REF	NucleoSpin® 8 Virus	
	12 x 8 preps 740643	60 x 8 preps 740643.5
Lysis Buffer RAV1 ¹	2 x 40 mL	8 x 40 mL
Wash Buffer RAW	75 mL	300 mL
Wash Buffer RAV3 (Concentrate) ¹	50 mL	2 x 100 mL
RNase-free H ₂ O	30 mL	125 mL
Elution Buffer RE ²	30 mL	125 mL
Carrier RNA (lyophilized) ¹	2 x 1 mg	8 x 1 mg
Proteinase K (lyophilized) ¹	50 mg	3 x 75 mg
Proteinase Buffer PB	8 mL	15 mL
NucleoSpin® Virus Binding Strips (blue rings)	12	60
MN Square-well Blocks	6	20
Rack of Tube Strips ³	4	15
Self-adhering PE Foil	10	50
User manual	1	1

¹ For preparation of working solutions and storage conditions see section 3.

² Elution Buffer RE: 5 mM Tris/HCl, pH 8.5

³ Set of 1 rack, 12 strips with 8 tubes each, Cap Strips included

1.1 Kit contents *continued*

NucleoSpin® 8 Virus Core Kit	
REF	48 x 8 preps 740451.4
Lysis Buffer RAV1 ¹	6 x 40 mL
Wash Buffer RAW	300 mL
Wash Buffer RAV3 (Concentrate) ¹	2 x 100 mL
RNase-free H ₂ O	125 mL
Elution Buffer RE ²	125 mL
Carrier RNA (lyophilized) ¹	6 x 1 mg
NucleoSpin® Virus Binding Strips (blue rings)	48
User manual	1

1.2 Reagent to be supplied by user

- 96–100 % ethanol (for preparation of working solutions; see section 3)

For more detailed information regarding special hardware required for centrifuge or vacuum processing, please see section 2.3.

For recommended accessories for use of the flexible **NucleoSpin® 8 Virus Core Kit** (reduced kit composition; REF 740451.4), please see section 2.4.

¹ For preparation of working solutions and storage conditions see section 3.

² Elution Buffer RE: 5 mM Tris/HCl, pH 8.5

2 Product description

2.1 The basic principle

The **NucleoSpin® 8 Virus** kit is designed for the simultaneous purification of viral RNA and DNA. The kit combines the selectivity of well established silica membrane binding of nucleic acids with medium-throughput 8-well format. With the **NucleoSpin® 8 Virus** method, RNA viruses are quickly and efficiently lysed by Lysis Buffer RAV1 which is a highly concentrated GITC solution. Compared to RNA viruses, DNA viruses (e.g., HBV) are usually more difficult to isolate and require a digestion of samples with Proteinase K which is provided in the kit. Lysis buffer and ethanol create appropriate conditions for binding of nucleic acids to the silica membrane of the NucleoSpin® Virus Binding Strips. Carrier RNA included in Lysis Buffer RAV1 improves binding and recovery of low concentrated viral RNA/DNA. Contaminations (potential PCR inhibitors) like salts, metabolites, and soluble macromolecular cellular components are removed in washing steps with ethanolic Wash Buffer RAW and Buffer RAV3. The purified viral nucleic acids can be eluted in low salt buffer or water and are ready-to-use in subsequent downstream applications like RT-PCR or PCR.

Choice of NucleoSpin® Virus kits

The **NucleoSpin® 8 Virus** kit allows the purification of multiples of 8 samples. The kit is primarily designed for manual use in a centrifuge. A vacuum use of this kit allows more variation and higher flexibility in the consumables used for lysis, washing, and elution. MACHEREY-NAGEL takes this into account by introducing the **NucleoSpin® 8 Virus Core Kit**, which is primarily recommended for manual or automated vacuum use. The core kits contain the core items like binding strips and buffers but no accessories like plastics or enzymes. The core kits together with a large variety of suitable disposables ensure the highest degree of flexibility for the user. To choose the most appropriate kit for your needs please refer to the following 'kit selection guide'. The **NucleoSpin® 8 Virus** kit is also available as 96-well plate kit for high-throughput (see ordering information).

Table 1: Kit selection guide

	Application	Kit recommendation
Manual use, centrifuge	Low-/medium throughput	NucleoSpin® 8 Virus
	High throughput	NucleoSpin® 96 Virus*
Manual use, vacuum	Low-/medium throughput	NucleoSpin® 8 Virus NucleoSpin® 8 Virus Core Kit
	High throughput	NucleoSpin® 96 Virus* NucleoSpin® 96 Virus Core Kit*
Automated use, vacuum or centrifuge	Low-/medium throughput	NucleoSpin® 8 Virus Core Kit
	High throughput	NucleoSpin® 96 Virus Core Kit*

* Please refer to the NucleoSpin® 96 Virus user manual. See section 6.2 for ordering information.

2.2 Kit specifications

- **NucleoSpin® 8 Virus** allows the parallel purification of viral DNA and RNA from 100–150 µL plasma, serum, or other cell-free biological fluids. Samples can either be fresh or frozen. Furthermore, particle-free supernatants of tissue suspensions, supernatants of stool samples, swab material, or diluted blood samples may also be processed. For detailed information on sample pre-treatment please refer to section 2.6.
- The purified nucleic acids are suitable for applications like real-time PCR/RT-PCR, PCR, or any kind of enzymatic manipulation. The detection limit for certain viruses depends on individual procedures, for example in-house nested (RT-) PCR. Use of internal extraction control samples as well as positive and negative amplification controls in order to monitor the purification, amplification and detection processes is highly recommended.
- **NucleoSpin® 8 Virus Core Kit** is primarily designed for vacuum use (for manual use or automated use on robotic platforms). Processing under vacuum allows easy automation on common liquid handling instruments. For more information about the automation process and the availability of ready-to-run scripts for certain platforms please refer to section 2.5 and contact your local distributor or MN directly.

Table 2: Kit specifications at a glance

Parameter	NucleoSpin® 8 Virus (Core Kit)
Technology	Silica-membrane technology
Format	8-well strips
Processing	Manual or automated, vacuum or centrifugation
Sample volume	100–150 µL*
Typical recovery	> 90%
Analysis limit	30–60 cp/mL
Elution volume	70–100 µL
Preparation time	60 min/6 strips
Binding capacity	40 µg

* Lysis must be done in MN Square-well Blocks if sample size is 150 µL. Additional MN Square-well Blocks may be necessary (see ordering information).

2.3 Required hardware

Centrifugation

For centrifugation a microtiterplate centrifuge which is able to accommodate the NucleoSpin® Virus Binding Strips stacked on a Round- or Square-well Block and reaches accelerations of 5,600–6,000 x *g* is required (bucket height: 85 mm). For processing the 8-well strips of the **NucleoSpin® 8 Virus** kit, the Starter Set C (containing Column Holders C, MN Square-well Blocks, Rack of Tube Strips; see ordering information) is required, too. For detailed information refer to the Starter Set C manual.

Vacuum processing



Although the **NucleoSpin® 8 Virus** kit is designed primarily for processing under centrifugation, processing under vacuum is also possible. The dead volume for the elution step is higher in comparison to centrifuge based elution. In order to achieve highly concentrated eluates and to avoid contamination, it is recommended performing the elution step by centrifugation. Consumables for vacuum processing differ from the consumables required for centrifugation. Therefore, for vacuum processing, we recommend using the **NucleoSpin® 8 Virus Core Kit**. For manual processing under vacuum a NucleoVac 96 Vacuum Manifold (see ordering information) is required for **NucleoSpin® 8 Virus Core Kit**. If the **NucleoSpin® 8 Virus (Core Kit)** is used with vacuum in addition to NucleoVac 96 Vacuum Manifold, the Starter Set A (containing Column Holders A and **NucleoSpin® Dummy Strips**, see ordering information) is required.



2.4 Recommended accessories for use of the NucleoSpin® 8 Virus Core Kit

The **NucleoSpin® 8 Virus Core Kit** provides the buffers, Carrier RNA, and NucleoSpin® Virus Binding Strips. Accessory plates (e.g., lysis plates, elution plates, and Proteinase K) are not provided with the core kits. The user can individually select additional consumables from a variety of suitable accessory plates according to his requirements for highest flexibility.

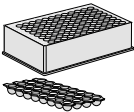
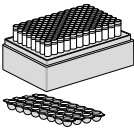
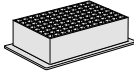
For use of the **NucleoSpin® 8 Virus Core Kit**, follow the standard protocols (see section 5).

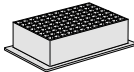
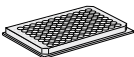
Recommended accessories for use of the **NucleoSpin® 8 Virus Core Kit** is available from MACHEREY-NAGEL. For ordering information, please refer to section 6.2.

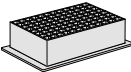
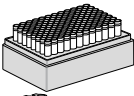
Protocol step	Suitable consumables, not supplied with the core kits	Remarks
1. Lyse samples	Round-well Block with 12 Cap Strips  or Rack of Tube Strips with 12 Cap Strips 	Round-well Blocks and Tube Strips can be closed with Cap Strips.
	or MN Square-well Block Square-well Block  Proteinase K	Square-well Blocks cannot be closed with Cap Strips. Closing with a Self-adhering PE Foil is not recommended (no tight sealing when mixing). Repeated pipetting up and down is recommended for mixing samples with Buffer RAV1. For certain samples and for viral DNA isolation use of Proteinase K is required.
2. Adjust binding conditions	Cap Strips 	When using Round-well Block or Tube Strips for lysis, new Cap Strips are required for closure of wells.
3 Transfer samples	MN Square-well Block 	Can be used for waste collection if required.
4 Bind nucleic acids to the membrane	MN Wash Plate 	MN Wash Plate minimizes the risk of cross contamination. (used for vacuum processing only)

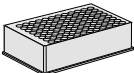
Protocol step	Suitable consumables, not supplied with the core kits	Remarks
7. Wash silica membrane*	MN Square-well Block 	Can be used for waste collection if required.
8. Elute DNA	Rack of Tubes Strips with Cap Strips   or Round-well Block 	Round-well Blocks and Tube Strips can be closed with Cap Strips

2.5 Automated processing on robotic platforms

For automated use we recommend using the **NucleoSpin® 8 Virus Core Kit** which can be automated on many common laboratory workstations. For a protocol which can be used as a guideline to create robotic script see section 5.2. For the availability of scripts and general considerations about adapting **NucleoSpin® 8 Virus Core Kit** on a certain workstation please contact MACHEREY-NAGEL.

For vacuum processing the use of the disposable MN Wash Plate inside the vacuum manifold is recommended. Use of the MN Wash Plate reduces the risk of cross-contamination caused by spraying of solutions during vacuum filtration steps. Visit MN online at www.mn-net.com or contact your local MACHEREY-NAGEL distributor for technical support regarding hardware, software, setup instructions, and selection of the protocol.

* Use of MN Square-well Block is optional. For waste collection the waste tray of the NucleoVac 96 Vacuum Manifold can be used.

2.6 Sample material

Liquid samples

Biological fluids or semi-fluid samples can be processed (e.g., serum, urine, or bronchoalveolar lavage). For successful nucleic acid purification it is important to obtain a homogeneous, clear, and non-viscous sample before loading onto the NucleoSpin® Virus Binding Strips. Therefore, check all samples (especially old or frozen ones) for presence of precipitates. Precipitates can be removed after addition of Lysis Buffer RAV1 and lysis incubation by centrifugation. Avoid clearing samples by centrifugation/filtration before the Buffer RAV1-lysis step, because viruses of interest may be associated with particles or aggregates. Incubation with Buffer RAV1 can be prolonged in order to dissolve and digest residual cell structures, precipitates and virus particles. RNA, however, is sensitive and prolonged incubation may cause decreased yields.

Solid samples (tissue samples, stool samples)

Prepare a 10% (w/v) suspension of tissue in buffer (e.g., PBS) using commercial homogenization tools (rotor-stator or bead-based homogenization tools, etc.). Centrifuge the suspension in order to remove particles. Use the clear particle-free supernatant for further processing.

Swab material

Incubate swab in a suitable buffer (e.g., PBS) or cell-culture medium for 30 min. Proceed with particle-free buffer or medium.

Blood samples

Processing of blood samples is possible if using blood diluted with PBS buffer. Using undiluted blood may cause clogging of the silica membrane of the NucleoSpin® Virus Binding Strips. The amount of PBS buffer added to blood samples has to be optimized for the individual organism. As a rule of thumb we recommend to start with 50 µL blood diluted with 50 µL PBS buffer.

Sample volume

The **NucleoSpin® 8 Virus** and **NucleoSpin® 8 Virus Core Kits** are specified for a sample volume of 100 µL. If necessary, the sample volume can be increased to 150 µL. For sample volumes of 150 µL the volumes of Lysis Buffer RAV1 and ethanol have to be increased to 600 µL each. Depending on the size of pipetting tips, the total lysate volume of 1300 µL may be loaded in two steps onto the NucleoSpin® Virus Binding Strips. The buffers supplied with the kit are sufficient for processing a sample volume of 150 µL*.

* Lysis must be done in MN Square-well Blocks if sample size is 150 µL. Additional MN Square-well Blocks may be necessary (see ordering information).

Proteinase K treatment

Addition of Proteinase K solution is necessary for the isolation of viral DNA or simultaneous viral RNA/DNA isolation. For isolation of viral RNA Proteinase K treatment is usually not required. Proteinase K treatment is recommended for viral RNA isolation when viscous samples have to be processed (e.g., sputum samples).

Sample lysis

For isolation of viral RNA in general a lysis of samples in Buffer RAV1 for 10 min at room temperature (18–25 °C) will be sufficient. For isolation of viral RNA from viscous samples, for example sputum or supernatants of tissue suspensions or stool samples, a lysis at 70 °C may be required. For simultaneous isolation of viral RNA and DNA, incubation time (e.g., 5–15 min), and temperature (e.g., RT, 56 °C, or 70 °C) should be optimized and adjusted to the sample material used.

2.7 Carrier RNA

The **NucleoSpin® 8 Virus** and **NucleoSpin® 8 Virus Core Kits** include Carrier RNA that enhances binding of viral nucleic acids to the silica membrane and reduces the risk of viral RNA degradation. Please note that eluates of the **NucleoSpin® 8 Virus** kit contain both viral nucleic acids and Carrier RNA with amounts of Carrier RNA that may exceed the amount of viral nucleic acids. Therefore it is not possible to quantify the nucleic acids isolated with the kit by photometric or fluorometric methods when using the carrier. Thus, other methods for quantification such as specific quantitative PCR or RT-PCR systems are recommended. Furthermore, Carrier RNA may inhibit PCR reactions. The amount of added Carrier RNA may thus be carefully optimized depending on the individual PCR system used.

2.8 Elution procedures

Recovery of viral RNA or DNA from the membrane depends on the elution volume. Elution volumes of 75–200 µL are possible, with an optimum of 100–125 µL dispensed volume. The dead volume of the membrane is approx. 45 µL and the recovered elution buffer can thus easily be estimated.

Highly concentrated eluates: When using a minimal elution volume (75–100 µL), about 70–80% of bound nucleic acids can be eluted, resulting in highly concentrated RNA/DNA. Alternatively, elution can be done in two steps with, for example 75 µL each, resulting in a higher elution efficiency but with a lower concentrated eluate.

Preheated elution buffer (70 °C): Use preheated elution buffer to increase overall yield. Optionally, following addition of preheated elution buffer incubate the NucleoSpin® Virus Binding Strips for 3 min at 60–70 °C before elution.

3 Storage conditions and preparation of working solutions

Attention: Buffers RAV1 and RAW contain guanidinium salts! Wear gloves and goggles!

CAUTION: Buffer RAV1 contains guanidinium thiocyanate and Buffer RAW contains guanidine hydrochloride which can form highly reactive compounds when combined with bleach (sodium hypochlorite). DO NOT add bleach or acidic solutions directly to the sample-preparation waste.

Before starting any **NucleoSpin® 8 Virus (Core Kit)** protocol, prepare the following:

- **Wash Buffer RAV3:** Add indicated volume of 96–100 % ethanol to the **Wash Buffer RAV3 Concentrate**. Mark the label of the bottle to indicate that ethanol was added.
- Before first use of the kit, add the indicated volume of **Proteinase Buffer PB** to dissolve lyophilized Proteinase K. Proteinase K solution is stable at -20 °C for 6 months. Dividing the solution into aliquots is recommended.
- Before use, add 1 mL Lysis Buffer RAV1 to the **Carrier RNA** tube. Dissolve the RNA and transfer it back to the Buffer RAV1 bottle. Mark the label of the bottle to indicate that Carrier RNA was added. Due to the production procedure and the small amount of Carrier RNA contained in the vial, the Carrier RNA may hardly be visible in the vial.

Carrier RNA has a limited shelf-life in Buffer RAV1. For this reason the **NucleoSpin® 8 Virus (Core Kit)** kit contains several vials of lyophilized Carrier RNA which should be used successively as required.

Storage of Carrier RNA in Buffer RAV1

Buffer RAV1 with Carrier RNA can be stored at room temperature for 1–2 weeks. Storage at room temperature prevents salt precipitation and avoids pre-heating of the buffer solution!

For storage for up to 4 weeks storage of Buffer RAV1 with added Carrier RNA at 4 °C is recommended. For long time storage Buffer RAV1 with added Carrier RNA can be stored in aliquots at -20 °C. Storage at 4 °C or below may cause salt precipitation. Therefore, the mixture must be preheated at 40–60 °C for a maximum of 5 min in order to dissolve precipitated salts.

Attention:

Frequent heating, temperatures > 80 °C, and extended heat incubation will lead to the degradation of the Carrier RNA and to reduced recovery of viral RNA and eventually false negative RT-PCR results, in particular if low-titer samples are used. Do not heat-up Buffer RAV1 containing Carrier RNA more than 4 times!

NucleoSpin® 8 Virus		
REF	12 x 8 preps 740643	60 x 8 preps 740643.5
Wash Buffer RAV3 (Concentrate)	50 mL Add 200 mL ethanol	2 x 100 mL Add 400 mL ethanol to each bottle
Proteinase K (lyophilized)	50 mg Add 2.5 mL Proteinase Buffer	3 x 75 mg Add 3.5 mL Proteinase Buffer to each vial
Carrier RNA (lyophilized)	1 mg Transfer to 40 mL Buffer RAV1	6 x 1 mg Transfer each vial to one bottle of 40 mL Buffer RAV1

NucleoSpin® 8 Virus Core Kit	
REF	48 x 8 preps 740451.4
Wash Buffer RAV3 (Concentrate)	2 x 100 mL Add 400 mL ethanol to each bottle
Carrier RNA (lyophilized)	6 x 1 mg Transfer each vial to one bottle of 40 mL Buffer RAV1



4 Safety instructions

The following components of the **NucleoSpin® 8 Virus** and **NucleoSpin® 8 Virus Core** kits contain hazardous contents.

Wear gloves and goggles and follow the safety instructions given in this section.

GHS classification

Only harmful features need not be labeled with H and P phrases up to 125 mL or 125 g.
Mindergefährliche Eigenschaften müssen bis 125 mL oder 125 g nicht mit H- und P-Sätzen gekennzeichnet werden.

Component	Hazard contents	GHS symbol	Hazard phrases	Precaution phrases
<i>Inhalt</i>	<i>Gefahrstoff</i>	<i>GHS Symbol</i>	<i>H-Sätze</i>	<i>P-Sätze</i>
RAV1	Guanidinium thiocyanate 30–60 % <i>Guanidiniumthiocyanat 30–60 %</i>	 Warning <i>Achtung</i>	302, 412, EUH031	260, 273, 301+312, 330
RAW	Guanidinium hydrochloride 24–36 % + isopropanol 35–55 % <i>Guanidiniumhydrochlorid 24–36 % + Isopropanol 35–55 %</i>	 Warning <i>Achtung</i>	226, 302,	210, 233, 301+312, 330, 403+235
Proteinase K	Proteinase K, lyophilized <i>Proteinase K, lyophilisiert</i>	 Danger <i>Gefahr</i>	315, 319, 334, 335	261, 280, 302+352, 304+340, 305+351+338, 312, 332+313, 337+313, 342+311, 403+233

Hazard phrases

H 226	Flammable liquid and vapour. <i>Flüssigkeit und Dampf entzündbar.</i>
H 302	Harmful if swallowed. <i>Gesundheitsschädlich bei Verschlucken.</i>
H 315	Causes skin irritation. <i>Verursacht Hautreizungen.</i>
H 319	Causes serious eye irritation. <i>Verursacht schwere Augenreizung.</i>
H 334	May cause allergy or asthma symptoms or breathing difficulties if inhaled. <i>Kann bei Einatmen Allergie, asthmaartige Symptome oder Atembeschwerden verursachen.</i>
H 335	May cause respiratory irritation. <i>Kann die Atemwege reizen.</i>

- H 412 Harmful to aquatic life with long lasting effects.
Schädlich für Wasserorganismen, mit langfristiger Wirkung.
- EUH031 Contact with acids liberates toxic gas.
Entwickelt bei Berührung mit Säure giftige Gase.

Precaution phrases

- P 210 Keep away from heat, hot surfaces, sparks, open flames and other ignition sources. No smoking.
Von Hitze, heißen Oberflächen, Funken, offenen Flammen sowie anderen Zündquellenarten fernhalten. Nicht rauchen.
- P 233 Keep container tightly closed.
Behälter dicht verschlossen halten.
- P 260 Do not breathe vapours.
Dampf nicht einatmen.
- P 261 Avoid breathing dust.
Einatmen von Staub vermeiden.
- P 273 Avoid release to the environment.
Freisetzung in die Umwelt vermeiden.
- P 280 Wear protective gloves / eye protection.
Schutzhandschuhe / Augenschutz tragen.
- P 301+312 IF SWALLOWED: Call a POISON CENTER/ doctor/.../if you feel unwell.
BEI VERSCHLUCKEN: Bei Unwohlsein GIFTINFORMATIONSZENTRUM / Arzt /... anrufen.
- P 302+352 IF ON SKIN: Wash with plenty of water/...
BEI KONTAKT MIT DER HAUT: Mit viel Wasser/... waschen.
- P 304+340 IF INHALED: Remove victim to fresh air and keep at rest in a position comfortable for breathing.
BEI EINATMEN: An die frische Luft bringen und in einer Position ruhigstellen, die das Atmen erleichtert.
- P 305+351+338 IF IN EYES: Rinse cautiously with water for several minutes. Remove contact lenses, if present and easy to do. Continue rinsing.
Bei Kontakt mit den Augen: Einige Minuten lang behutsam mit Wasser spülen. Vorhandene Kontaktlinsen nach Möglichkeit entfernen. Weiter spülen.
- P 312 Call a POISON CENTER/ doctor/.../if you feel unwell.
Bei Unwohlsein GIFTINFORMATIONSZENTRUM / Arzt /... anrufen.
- P 330 Rinse mouth.
Mund ausspülen.
- P 332+313 IF skin irritation occurs: Get medical advice / attention.
Bei Hautreizung: Ärztlichen Rat einholen / ärztliche Hilfe hinzuziehen.
- P 337+313 If eye irritation persists: Get medical advice / attention.
Bei anhaltender Augenreizung: Ärztlichen Rat einholen / ärztliche Hilfe hinzuziehen.
- P 342+311 If experiencing respiratory symptoms: Call a POISON CENTER/ doctor/...
Bei Symptomen der Atemwege: GIFTINFORMATIONSZENTRUM / Arzt /... anrufen.
- P 403+233 Store in a well ventilated place. Keep container tightly closed.
Behälter dicht verschlossen an einem gut belüfteten Ort aufbewahren.
- P 403+235 Store in a well ventilated place. Keep cool.
Kühl an einem gut belüfteten Ort aufbewahren.

For further information please see Material Safety Data Sheets (www.mn-net.com).
Weiterführende Informationen finden Sie in den Sicherheitsdatenblättern (www.mn-net.com).

5 Protocols

5.1 NucleoSpin® 8 Virus – centrifuge processing

- For hardware requirements, refer to section 2.3.
- For detailed information on each step see page 21.
- For use of the NucleoSpin® 8 Virus Core Kit (REF 740451.4), refer to section 2.4 regarding recommended accessories.

Before starting the preparation:

- Check if Buffer RAV1, Buffer RAV3, and Proteinase K were prepared according to section 3.
- Set incubator or oven to 25–70 °C.
- Preheat Elution Buffer RE or water to 70 °C.

Protocol-at-a-glance

1	Lyse samples	100 µL sample 400 µL Buffer RAV1 (20 µL Proteinase K) Mix 25–70 °C, 10 min
2	Adjust binding conditions	400 µL ethanol (96–100 %) Mix
3	Transfer samples to NucleoSpin® Virus Binding Strips	
4	Bind viral nucleic acids to silica membrane of the NucleoSpin® Virus Binding Strips	5,600–6,000 x g, 2 min

5	Wash silica membrane	500 µL RAW
		5,600–6,000 x g, 2 min
		700 µL RAV3
		5,600–6,000 x g, 2 min
		700 µL RAV3
		5,600–6,000 x g, 15 min

6	Elute viral RNA and DNA	100 µL RE (70 °C)
		5,600–6,000 x g, 2 min

Optional: Repeat elution step once.

Detailed protocol

This standard protocol is recommended for purification of viral RNA from, for example HCV or HIV. DNA viruses such as CMV can also be isolated but lysis including Proteinase K digestion is recommended.

The use of NucleoSpin® Virus Binding Strips in a Column Holder C allows the isolation of up to $n \times 8$ samples ($n = 1-6$). Insert as many of the NucleoSpin® Virus Binding Strips as required into the same positions of each one of the two reusable column holders and place column holders onto the MN Square-well Blocks. Label the column holders or 8-well strips for later identification.

Always use 2 Column Holders C containing identical numbers of NucleoSpin® Virus Binding Strips for centrifugation. This avoids the need to balance the centrifuge, and allows multiples of 16 samples to be processed in parallel. We recommend inserting the NucleoSpin® Virus Binding Strips around the center of the column holder.

- For hardware requirements, refer to section 2.3.
- For use of the NucleoSpin® 8 Virus [Core Kit](#) (REF 740451.4), refer to section 2.4 regarding recommended accessories.

Before starting the preparation:

- Check if Buffer RAV1, Buffer RAV3, and Proteinase K were prepared according to section 3.
- Set incubator or oven to 25–70 °C.
- Preheat Elution Buffer RE or water to 70 °C.

1 Lyse samples

Pipette **400 µL Buffer RAV1** into the wells of a Rack of Tube Strips or Round-well Block according to the number of samples. Dispense solution to the bottom of the wells.

If 150 µL sample are to be prepared, pipette 600 µL Buffer RAV1 into the wells.*

We recommend using an electronic 8-channel pipetting device with extra long tips capable of holding more than 650 µL.

Add **100 µL sample** to each Buffer RAV1-filled well. Take care to dispense the sample directly into Buffer RAV1. Pipette mixture up and down several times. Do not moisten the rims.

Close Tube Strips or Round-well Block with Cap Strips. Incubate mixture for **10 min at room temperature (18–25 °C)**.

* Lysis must be done in MN Square-well Blocks if sample size is 150 µL. Additional MN Square-well Blocks may be necessary (see ordering information).

Optional: Add 20 µL Proteinase K to each sample pre-mixed with Buffer RAV1. Close the lysis vessels with Cap Strips and incubate for 5–10 min at 56–70 °C. Addition of Proteinase K is required for viral DNA extraction and may be useful for viral RNA extraction from some sample types. For details on incubation time and temperature see section 2.6.

Spin down droplets (30 s; 1,500 x g) before opening the Cap Strips.

2 Adjust binding conditions

Remove Cap Strips and add **400 µL ethanol (96–100 %)** to each lysate. Take care not to moisten the rims of the individual wells while dispensing. Close the individual wells with new Cap Strips (supplied). Invert 10 times and **mix** by shaking for 15 s. Spin down droplets (30 s; 1,500 x g) from the Cap Strips.

If 150 µL sample has been prepared, add 600 µL ethanol (96–100 %) to each lysate.

3 Transfer samples to binding strips

Remove the first Cap Strip and transfer all of each sample into the wells of a NucleoSpin® Virus Binding Strip positioned on top of the MN Square-well Block. Do not moisten the rims of the individual wells while dispensing samples (moistened rims may cause cross-contamination during centrifugation). Seal NucleoSpin® Virus Binding Strips with Self-adhering PE Foil.

4 Bind RNA and DNA to silica membrane

Place the MN Square-well Blocks with Binding Strips onto the centrifuge carrier and insert it into the rotor buckets. Centrifuge at **5,600–6,000 x g** for **2 min**.

Typically, samples will pass through the columns within ≤ 1 min.

Optional: If 150 µL sample has been prepared, load it in successive steps onto the NucleoSpin® Virus Binding Strips as described in step 3. In this case use a new MN Square-well Block for the washing steps as the maximum volume of the MN Square-well Block may be exceeded (additional MN Square-well Blocks are not included in the kit, see ordering information).

5 Wash silica membrane

1st wash

Remove Self-adhering PE Foil and add **500 µL Buffer RAW** to each well of the NucleoSpin® Virus Binding Strips. Seal the NucleoSpin® Virus Binding Strips with new Self-adhering PE Foil. Centrifuge at **5,600–6,000 x g** for **1–2 min**.

Remove Self-adhering PE Foil and place NucleoSpin® Virus Binding Strips onto a new MN Square-well Block.

2nd wash

Add **700 µL Buffer RAV3** to each well of the NucleoSpin® Virus Binding Strips. Seal with new Self-adhering PE Foil. Centrifuge at **5,600–6,000 x g** for **1–2 min**.

3rd wash

Repeat second wash step once. Prolong centrifugation to **15 min** in order to remove ethanol from residual Wash Buffer RAV3.

Alternatively, remove the adhesive foil and place the NucleoSpin® Virus Binding Strips into an incubator for 20 min at 37 °C to evaporate residual ethanol.

Removal of ethanol by evaporation at 37 °C is more effective than additional, prolonged centrifugation (15 min, 6,000 x g).

6 Elute viral RNA and DNA

Place the NucleoSpin® Virus Binding Strips onto the Rack of Tube Strips.

Dispense **75–100 µL RNase-free water** or **Buffer RE (preheated to 70 °C)** to each well of the NucleoSpin® Virus Binding Strips. Pipette the buffer directly onto the membrane. Incubate at room temperature for 1 min. Seal with a new Self-adhesive PE Foil. Centrifuge at **5,600–6,000 x g** for **2–3 min**.

Tube Strips containing eluted RNA/DNA can be conveniently closed with Cap Strips for storage.

Yields will be 10–15% higher when eluting in 100–200 µL water. The concentration of nucleic acids in the complete eluate, however, will be lower. For RT-PCR /PCR a more concentrated eluate is favorable. If only viral DNA is processed, elution should be done with Elution Buffer RE optimized for elution and storage of DNA.

5.2 NucleoSpin® 8 Virus (Core Kit) – vacuum processing

- For hardware requirements refer to section 2.3.
- For detailed information on each step see page 27.
- For detailed information regarding the vacuum manifold setup, see page 26.
- For use of the **NucleoSpin® 8 Virus Core Kit** (REF 740451.4), refer to section 2.4 regarding recommended accessories.

Before starting the preparation:

- Check if Buffer RAV1, Buffer RAV3, and Proteinase K were prepared according to section 3.
- Set incubator or oven to 25–70 °C.
- Preheat Elution Buffer RE or water to 70 °C.

Protocol-at-a-glance

1	Lyse samples	100 µL sample 400 µL Buffer RAV1 (20 µL Proteinase K) Mix 25–70 °C, 10 min
2	Adjust binding conditions	400 µL ethanol (96–100 %) Mix
3	Transfer samples to NucleoSpin® Virus Binding Strips	
4	Bind nucleic acids to silica membrane of the NucleoSpin® Virus Binding Strips	-0.2 bar* , 5 min

* Reduction of atmospheric pressure

Setup of vacuum manifold:

Binding / Washing steps

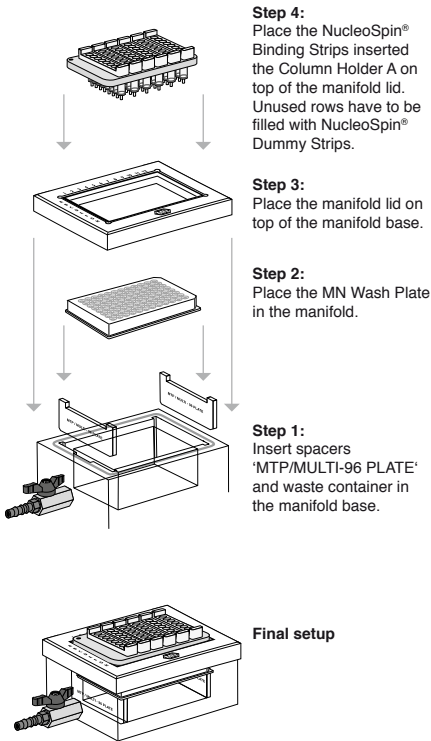

Elution step

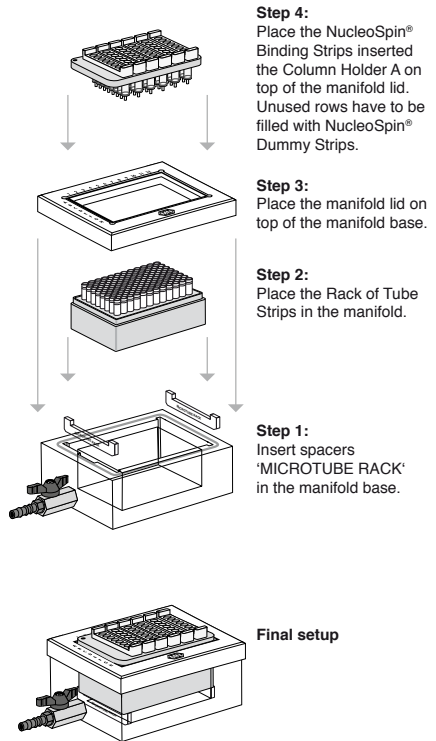

Detailed protocol

Whereas the use of a centrifuge for the processing of the **NucleoSpin® 8 Virus** kit determines most of the consumables to be used (Tube Strips, MN Square-well Blocks, etc.) the vacuum use of the kit allows for more variation and higher flexibility.

Especially when processing a large number of samples under vacuum, cross-contamination is a major concern due to spraying of liquids or aerosol formation. The use of the MN Wash Plate* prevents the contamination by droplets at the outlets of the individual wells of the NucleoSpin® Binding Strips. This very assistant tool is thus recommended for vacuum processing.

When using the **NucleoSpin® 8 Virus Core Kit** under vacuum, the NucleoVac 96 Vacuum Manifold is required (see ordering information). For use of the **NucleoSpin® 8 Virus Core Kit** in addition the Starter Set A is required which contains the Column Holder A and the NucleoSpin® Dummy Strips to close/seal unused rows of the column holder when applying vacuum.

The use of NucleoSpin® Virus Binding Strips in a Column Holder A allows the isolation of up to $n \times 8$ samples ($n = 1-6$). Insert as many of the NucleoSpin® Virus Binding Strips as required into the reusable column holder. Close unused openings of the column holder with NucleoSpin® Dummy Strips and place column holders containing NucleoSpin® Virus Binding Strips and NucleoSpin® Dummy Strips onto NucleoVac 96 Vacuum Manifold. If a final elution step by centrifugation is preferred (recommended), either a Column Holder C or a Support Frame (Support Frame for centrifugation of Column Holder A, see ordering information) are required.

This standard protocol is recommended for purification of viral RNA from for example HCV or HIV. DNA viruses such as CMV can also be isolated but lysis including Proteinase K digestion is recommended (not included in the core kit).

- For hardware requirements refer to section 2.3.
- For detailed information regarding the vacuum manifold setup, see page 26.
- For use of the **NucleoSpin® 8 Virus Core Kit** (REF 740451.4), refer to section 2.4 regarding recommended accessories.

Before starting the preparation:

- Check if Buffer RAV1, Buffer RAV3, and Proteinase K were prepared according to section 3.
- Set incubator or oven to 25–70 °C.
- Preheat Elution Buffer RE or water to 70 °C

* The MN Wash Plate is not part of the kits. Please order separately (see ordering information).

1 Lyse samples

Pipette **400 µL Buffer RAV1** into the wells of a suitable vessel used for lysis. Dispense solution to the bottom of the wells.

If 150 µL sample are to be prepared, pipette 600 µL Buffer RAV1 into the wells.

We recommend using an electronic 8-channel pipetting device with extra long tips capable of holding more than 650 µL.

Add **100 µL sample** to each Buffer RAV1-filled well. Take care to dispense the samples directly into Buffer RAV1. Pipette mixture up and down several times. Do not moisten the rims.

Close the wells and incubate the mixture for **10 min at room temperature (18–25 °C)**.

Optional: Add 20 µL Proteinase K (20 mg/mL) to each sample pre-mixed with Buffer RAV1. Close the lysis vessels and incubate for 5–10 min at 56 °C–70 °C. Addition of Proteinase K is required for viral DNA extraction and may be useful for viral RNA extraction from some sample types. For details on incubation time and temperature please also refer to section 2.6.

Spin briefly (30 s, 1,500 x g) to collect any sample from the cover of the wells if required before opening the lysis vessels.

2 Adjust binding conditions

Remove the cover of the wells and add **400 µL ethanol (96–100 %)** to each sample. Take care not to moisten the rims of the individual wells while dispensing. Close the wells with a new cover, invert 10 x, and **mix** by shaking for 15 s. Spin briefly (30 s, 1,500 x g) to collect any sample from the cover of the wells.

If 150 µL sample has been prepared, add 600 µL ethanol (96–100 %) to each lysate.

3 Transfer samples to NucleoSpin® Virus Binding Strips

Place waste tray into vacuum manifold base. Other plates for waste collection can also be used. Insert spacers labeled 'MTP/MULTI-96 PLATE' notched side up and rest the MN Wash Plate on them. Close manifold and place NucleoSpin® Virus Binding Strips on top of the manifold. Column Holder A has to be used to fix the 8-well strips on the manifold. Seal unused openings of the Column Holder A with NucleoSpin® Dummy Strips.

Transfer samples to the wells of the binding strips and be careful not to moisten the rims of the wells.

* Lysis must be done in MN Square-well Blocks if sample size is 150 µL. Additional MN Square-well Blocks may be necessary (see ordering information).

4 Bind viral RNA and DNA to silica membrane

Apply vacuum of **-0.2 to -0.4 bar¹** (reduction of atmospheric pressure) to allow samples to pass through the membrane (2–5 min). Flow-through rate should be about 1–2 drops per second. Adjust vacuum strength accordingly.

5 Wash and dry silica membrane

1st wash

Add **500 µL Buffer RAW** to each well of the NucleoSpin® Virus Binding Plate. Apply vacuum (**-0.2 to -0.4 bar^{*}**) until all buffer has passed through the wells of the NucleoSpin® Virus Binding Strips (2–5 min). Release the vacuum.

2nd wash

Add **700 µL Buffer RAW3** to each well of the NucleoSpin® Virus Binding Plate. Apply vacuum (**-0.2 to -0.4 bar^{*}**) until all buffer has passed through the wells of the NucleoSpin® Virus Binding Strips (2–5 min). Release the vacuum.

3rd wash

Add **700 µL Buffer RAW3** to each well of the NucleoSpin® Virus Binding Plate. Apply vacuum (**-0.2 to -0.4 bar^{*}**) until all buffer has passed through the wells of the NucleoSpin® Virus Binding Strips (2–5 min). Release the vacuum.

Remove MN Wash Plate

After the final washing step close the valve, release the vacuum and remove the NucleoSpin® Virus Binding Strips. Put it on a clean paper towel to remove residual EtOH-containing wash buffer. Remove manifold lid, MN Wash Plate, and waste container from the vacuum manifold.

Reassemble the vacuum manifold and dry the membrane by applying maximum vacuum (e.g., **-0.6 bar^{*}**) for **15 minutes**.

^{*} Reduction of atmospheric pressure

6 Elute viral RNA and DNA

Place a suitable vessel used for elution on appropriate spacers (e.g., 'MICROTUBE RACK') into the manifold base. Close manifold and insert NucleoSpin® Virus Binding Strips onto manifold top. Dispense **100 µL RNase-free water** or **Buffer RE (preheated to 70 °C)** to each well of the strips. Pipette water directly onto the membrane. Incubate at room temperature for **2 – 3 min** and apply vacuum of **-0.4 bar¹** until all of the samples have passed.

If only viral DNA is processed, elution should be done with Elution Buffer RE optimized for elution and storage of DNA.

Optional: Repeat elution step once (incubation not required).

Note: Elution by vacuum may cause cross-contamination due to aerosol formation and spraying of droplets. If possible, it is thus recommended to use centrifugation for the elution step.

* Reduction of atmospheric pressure

6 Appendix

6.1 Troubleshooting

Problem	Possible cause and suggestions
Small amounts or no viral nucleic acids in the eluate	<p><i>Problems with Carrier RNA</i></p> <ul style="list-style-type: none"> Carrier RNA not added. See remarks concerning storage of Buffer RAV1 with Carrier RNA (section 2.7).
	<p><i>Proteinase K digestion</i></p> <ul style="list-style-type: none"> For certain sample types and for viral DNA isolation use of Proteinase K is required for the sample lysis step. Compare protocols with and without Proteinase K digestion. <p><i>Viral nucleic acids degraded</i></p> <ul style="list-style-type: none"> Samples should be processed immediately. If necessary, add RNase inhibitor to the sample. Create a nuclease-free environment and ensure that no nucleases are present. Use suitable tips and buffer reservoirs. Check that all buffers have been prepared and stored correctly. If in doubt, use new aliquots of Buffer RAV1 and elution buffer.
Problems with subsequent detection	<p><i>Reduced sensitivity</i></p> <ul style="list-style-type: none"> Carrier RNA may interfere with the PCR/RT-PCR system used. Change the volume of eluted viral DNA/RNA added to the PCR/RT-PCR. Use diluted eluates in order to exclude inhibition. Reduce Carrier RNA concentration in Buffer RAV1. Optimal concentration may require some preliminary experiments.
	<p><i>Ethanol carry-over</i></p> <ul style="list-style-type: none"> Extend centrifugation times in order to remove Buffer RAV3 completely. <p><i>PCR inhibition</i></p> <ul style="list-style-type: none"> Add an additional wash step with 96% ethanol following the last wash with Buffer RAV3.
General problems	<p><i>Clogged membrane</i></p> <ul style="list-style-type: none"> Centrifuge sample lysate before the addition of ethanol and subsequent loading onto NucleoSpin® Virus Binding Strips.

6.2 Ordering information

Product	REF	Pack of
NucleoSpin® 8 Virus	740643 740643.5	12 x 8 preps 60 x 8 preps
NucleoSpin® 8 Virus Core Kit	740451.4	48 x 8 preps
NucleoSpin® 96 Virus	740691.2 740691.4	2 x 96 preps 4 x 96 preps
NucleoSpin® 96 Virus Core Kit	740452.4	4 x 96 preps
Proteinase K	740506	100 mg
MN Square-well Block	740476	4
Square-well Block	740481	4
Round-well Block with Cap Strips (set consists of 1 Round-well Block and 12 Cap Strips)	740475	4
Rack of Tube Strips with Cap Strips (set consists of 1 Rack, 12 Tube Strips with 8 tubes each, and 12 Cap Strips)	740477	4
Cap Strips	740478	48
MN Wash Plates	740479	4
Self-adhering PE Foil	740676	50
MN Frame (for optimized handling of 96-well plates with vacuum manifold on BioRobot® 9600, 9604, and 3000 (Qiagen), MultiPROBE® II (PerkinElmer), Biomek® 2000, and FX (Beckman Coulter))	740680	1
Starter Set A (for use of 8-well strips on the NucleoVac 96 and automation platforms)	740682	1

Product	REF	Pack of
Starter Set C (for use of 8-well strips under centrifugation)	740684	1
NucleoVac 96 Vacuum Manifold	740681	1
NucleoVac Vacuum Regulator	740641	1
Support Frame for Column Holder A	740480	1

6.3 Product use restriction/warranty

NucleoSpin® 8 Virus (Core Kit) components are intended, developed, designed, and sold FOR RESEARCH PURPOSES ONLY, except, however, any other function of the product being expressly described in original MACHEREY-NAGEL product leaflets.

MACHEREY-NAGEL products are intended for GENERAL LABORATORY USE ONLY! MACHEREY-NAGEL products are suited for QUALIFIED PERSONNEL ONLY! MACHEREY-NAGEL products shall in any event only be used wearing adequate PROTECTIVE CLOTHING. For detailed information please refer to the respective Material Safety Data Sheet of the product! MACHEREY-NAGEL products shall exclusively be used in an ADEQUATE TEST ENVIRONMENT. MACHEREY-NAGEL does not assume any responsibility for damages due to improper application of our products in other fields of application. Application on the human body is STRICTLY FORBIDDEN. The respective user is liable for any and all damages resulting from such application.

DNA/RNA/PROTEIN purification products of MACHEREY-NAGEL are suitable for *IN VITRO*-USES ONLY!

ONLY MACHEREY-NAGEL products specially labeled as IVD are also suitable for *IN VITRO*-diagnostic use. Please pay attention to the package of the product. *IN VITRO*-diagnostic products are expressly marked as IVD on the packaging.

IF THERE IS NO IVD SIGN, THE PRODUCT SHALL NOT BE SUITABLE FOR *IN VITRO*-DIAGNOSTIC USE!

ALL OTHER PRODUCTS NOT LABELED AS IVD ARE NOT SUITED FOR ANY CLINICAL USE (INCLUDING, BUT NOT LIMITED TO DIAGNOSTIC, THERAPEUTIC AND/OR PROGNOSTIC USE).

No claim or representations is intended for its use to identify any specific organism or for clinical use (included, but not limited to diagnostic, prognostic, therapeutic, or blood banking). It is rather in the responsibility of the user or - in any case of resale of the products - in the responsibility of the reseller to inspect and assure the use of the DNA/RNA/protein purification products of MACHEREY-NAGEL for a well-defined and specific application.

MACHEREY-NAGEL shall only be responsible for the product specifications and the performance range of MN products according to the specifications of in-house quality control, product documentation and marketing material.

This MACHEREY-NAGEL product is shipped with documentation stating specifications and other technical information. MACHEREY-NAGEL warrants to meet the stated specifications. MACHEREY-NAGEL's sole obligation and the customer's sole remedy is limited to replacement of products free of charge in the event products fail to perform as warranted. Supplementary reference is made to the general business terms and conditions of MACHEREY-NAGEL, which are printed on the price list. Please contact us if you wish to get an extra copy.

There is no warranty for and MACHEREY-NAGEL is not liable for damages or defects arising in shipping and handling (transport insurance for customers excluded), or out of accident or improper or abnormal use of this product; defects in products or components not manufactured by MACHEREY-NAGEL, or damages resulting from such non-MACHEREY-NAGEL components or products.

MACHEREY-NAGEL makes no other warranty of any kind whatsoever, and SPECIFICALLY DISCLAIMS AND EXCLUDES ALL OTHER WARRANTIES OF ANY KIND OR NATURE WHATSOEVER, DIRECTLY OR INDIRECTLY, EXPRESS OR IMPLIED, INCLUDING, WITHOUT LIMITATION, AS TO THE SUITABILITY, REPRODUCTIVITY, DURABILITY, FITNESS FOR A PARTICULAR PURPOSE OR USE, MERCHANTABILITY, CONDITION, OR ANY OTHER MATTER WITH RESPECT TO MACHEREY-NAGEL PRODUCTS.

In no event shall MACHEREY-NAGEL be liable for claims for any other damages, whether direct, indirect, incidental, compensatory, foreseeable, consequential, or special (including but not limited to loss of use, revenue or profit), whether based upon warranty, contract, tort (including negligence) or strict liability arising in connection with the sale or the failure of MACHEREY-NAGEL products to perform in accordance with the stated specifications. This warranty is exclusive and MACHEREY-NAGEL makes no other warranty expressed or implied.

The warranty provided herein and the data, specifications and descriptions of this MACHEREY-NAGEL product appearing in MACHEREY-NAGEL published catalogues and product literature are MACHEREY-NAGEL's sole representations concerning the product and warranty. No other statements or representations, written or oral, by MACHEREY-NAGEL's employees, agent or representatives, except written statements signed by a duly authorized officer of MACHEREY-NAGEL are authorized; they should not be relied upon by the customer and are not a part of the contract of sale or of this warranty.

Product claims are subject to change. Therefore please contact our Technical Service Team for the most up-to-date information on MACHEREY-NAGEL products. You may also contact your local distributor for general scientific information. Applications mentioned in MACHEREY-NAGEL literature are provided for informational purposes only. MACHEREY-NAGEL does not warrant that all applications have been tested in MACHEREY-NAGEL laboratories using MACHEREY-NAGEL products. MACHEREY-NAGEL does not warrant the correctness of any of those applications.

Last updated: 07/2010, Rev. 03

Please contact:

MACHEREY-NAGEL GmbH & Co. KG

Tel.: +49 (0) 24 21 969 270

e-mail: tech-bio@mn-net.com

Trademarks:

Biomek® is a registered trademark of Beckman Coulter Inc.

BioRobot® is a registered trademark of the Qiagen Group

MultiPROBE® is a registered trademark of Perlin Elmer Inc.

NucleoSpin® is a registered trademark of MACHEREY-NAGEL GmbH & Co. KG

All used names and denotations can be brands, trademarks, or registered labels of their respective owner – also if they are not special denotation. To mention products and brands is only a kind of information (i.e., it does not offend against trademarks and brands and can not be seen as a kind of recommendation or assessment). Regarding these products or services we can not grant any guarantees regarding selection, efficiency, or operation.