

# **Law Enforcement Audio & Video Recorder**

User manual

# 1.Introduction

We sincerely thank you for using our company's new product---police camera.This manual is the introduction of this product which briefly introduces its functions、 features、 performance 、 external structure、 operation and caution items as a reference for users' convenience. Please read it carefully before use.

If the equipment fails or you have any confusions on the contents of this manual please contact us, suggestions and criticism are also welcome.

## Warning:

1. Far away from fire.
- 2.Avoiding put LCD screen and video's camera directly under the sun.

## Cautions:

1. Specific frequencies of electromagnetic waves may affect image quality.
- 2.Before you use the product to work, please do a test in order to master the use of video.

## 2.Product Overview

Law enforcement recorder is a prominent enforcement field audio and video recording product of our company, applying multiple latest video and audio processing technologies. With comprehensive functions and reliable performance, it can be widely used by public security organ, procuratorial organ, people's court, judicial organ, People's Armed Police, industry and commerce organ, tax authority and other law-enforcing departments. At the scene of law enforcement, law executors can use the equipment to record the conditions at the scene, collect evidence, standardize law-enforcing conduct, play back the picture of scene and assure the accuracy and fairness of law enforcement.

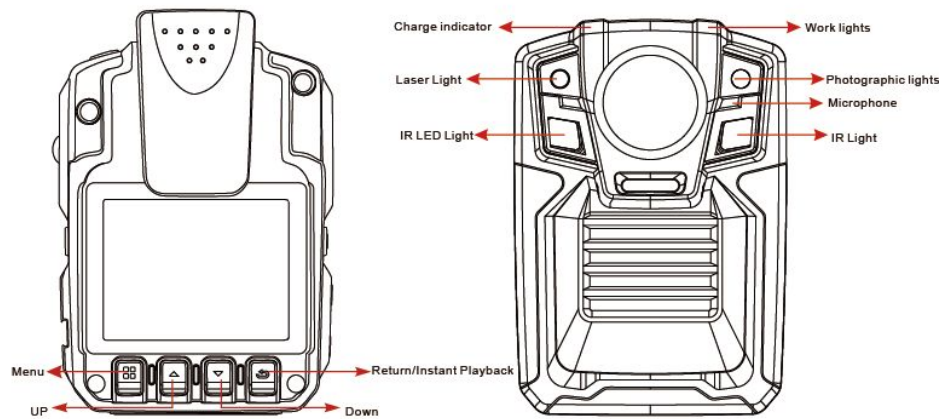

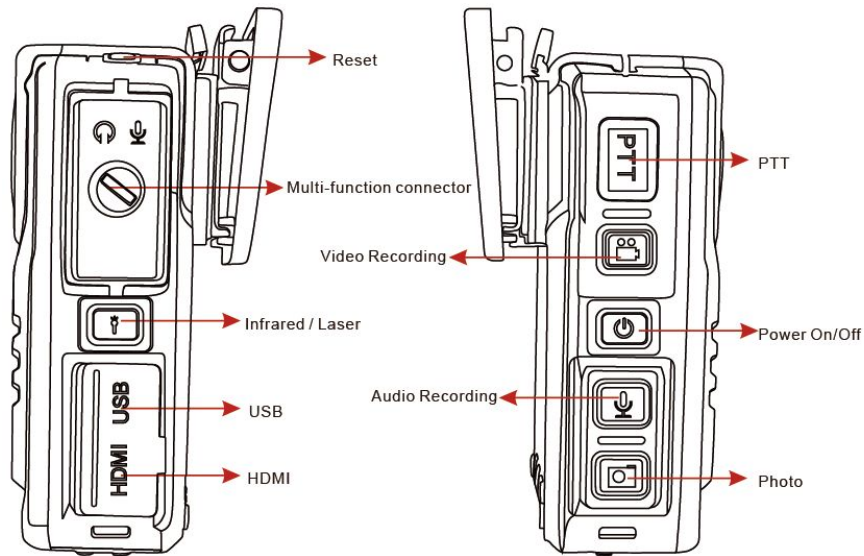

### 3. Main Features

- 1.Function of strong night vision, able to see the facial appearance of humans clearly within 10m in complete darkness.
- 2.Double-filter switcher, no color cast in the daytime, clearer in the nighttime.
- 3.Unable to look up or delete the data of recording files, unless authorized.
- 4.One-key remote operation (optional).
- 5.Function of character superimposition, all videos and pictures will be attached with time, device ID, police ID and other information, they are unable to be edited or rearranged, providing more effective legal evidence.
- 6.Super-long filename, filenames of all video files include device ID,

time, police ID and other information, convenient for data archiving and retrieving.

7.Can be fitted with external camera (AVIN function). Cameras of various models are available, such as Bluetooth camera, button camera, and camera equipped on the brim of hat, etc.

8.Full HD 1080P video recording.

9.Pre-recording the video, extended recording function, do not miss any law enforcement picture.

10.Four main functions, namely video recording, photo-shooting 、 sound recording and GPS.

11.Play audio, video and photo on scene

12.Video data will be partitioned and saved automatically, avoiding the data loss caused by faulty operation.

13.Three kinds of operation prompts, namely vibration, LED light and sound.

### **Performance Indicators**

Frame Rate: 30 f/s

Video bit rate: 2.5 M bit/S

Resolution ratio: 1920\*1080 1280\*720

848\*480

Wide angle: 130°

Illumination requirement: day and night (auxiliary IR)

Battery capacity: 1950mAh x2

Memory capacity: 16G(32G)

Contour dimension: 85\*62\*31mm

Weight: 150g

Operating temperature: 15-40° C

Working relative humidity : 40% – 80%

Storage temperature: -20 – 50°C

Storage relative humidity: 93% (40°C)

**Reference Data:**

Standby time: 24 hours

Continuous recording time: 5 hours (one battery full charged, IR closed, resolution ratio 848\*480)

Night control distance: more than 10 meters

## **4.Operation Introduction**

**Power On/ Off:**

Press the power switch button of law-enforcement recorder for 2 seconds, the equipment will be turned on and enter the standby mode.

Under any circumstance, press the power switch button for 2 seconds, the equipment will be powered off.

**Video-recording:**

After turned on, the equipment will directly enter the camera preview mode, directly press the recording button to record, the equipment will give two short vibrations, the red indicating light on its top will blink,

under the video-recording state, press the recording button again, the equipment will give two short vibrations together with beep prompt, the indicating light will stop blinking, the equipment will stop and save the video.

Under the power-off state, press the recording button for 2 seconds, the equipment will be turned on automatically and start the video-recording function, at this time, if needing to end and save the video, methods are same as above.

In case of shooting at dark night, press the IR button, then the IR light will be turned on and enter the night shooting mode, pictures shot at night are black and white.

### **Photo-shooting:**

After turned on, the equipment will directly enter the camera preview mode, press directly the photo button to shoot photos, in case of shooting at dark night, turn on the IR light or filling light of the equipment to shoot.

Under the video-recording state, press the photo button to capture the picture recorded at that time.

### **Sound recording:**

After turned on, the equipment will directly enter the camera preview mode, press directly the sound-recording button to record sound, at this time, the equipment is accompanying with prompts of beep, vibration,

and blink of yellow indicating light, the prompt that there is a picture under the sound-recording state will be displayed on the screen, under the sound-recording state, press the sound-recording button again to end and save audio file.

### **IR Video Function:**

Shortly press the manual light button, you can manually turn on / off infrared light, usually in ambient low outside light situations, you can filter poke shot from above and open infrared light, at that time the product goes to the infrared camera mode image and color reproduction will be reduced, it might change the black and white video, which is normal now.

### **Intercom functions:**

Choose optional USB connector to link interphone achieving intercom functions (intercom connection cable is optional).

### **Playback:**

The law-enforcement recorder is designed with one-touch playback button and quick playback button. Under the standby state, press the one-touch playback button, the equipment will play back the content shot at last automatically; if needing to play back selectively, press the playback button and then enter the playback menu to carry out operations.

### **Picture playback:**

Under the video-browsing state, press the playback button to enter



the playback menu button, select to enter the picture playback mode, press the Up button or the Down button to select the picture you want to view, press the OK button to select the picture you want to view. When choosing the slideshow mode to play pictures, pictures will be played in cycle under the slideshow mode.



### **Video playback**

Under the video preview state, press the playback button to enter the playback menu, select the video playback options. After entering the video playback menu, press the Up button or the Down button to select the video you want to play, press the OK button to play the video file you select at present.



## Audio playback

Under the video preview state, press the playback button to enter the playback menu, select to enter the audio playback menu, press the Up button or Down button to select the audio file you want to play, press the OK button to play back the audio file you select at present.

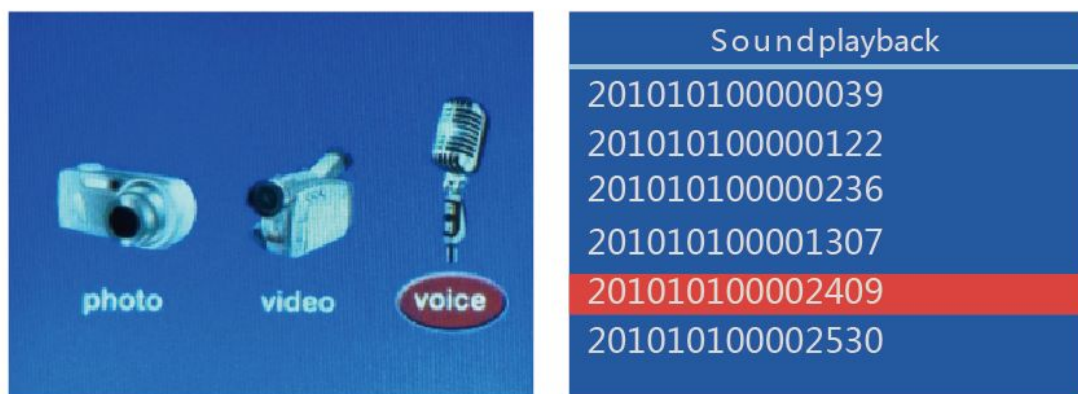

## 5.Parameters Setting

### Resolution:

After turned on, in the mode of framing and preview, press the menu button to enter into the interface of parameters setting and select options of resolution. Press “OK” button to enter. The resolution has four levels

of 1280\*720、1440\*1080 、1920\*1080 、848\*480 848\*480PH. Press “Up”, “Down” to select the suitable resolution. And press “OK” after selecting. Press “Back” can return to the previous menu.

## Code rate

There are three modes, High, medium and low. Press the Up and Down keys to select the appropriate mode, select OK When finished, press the ok key. Return to main menu.

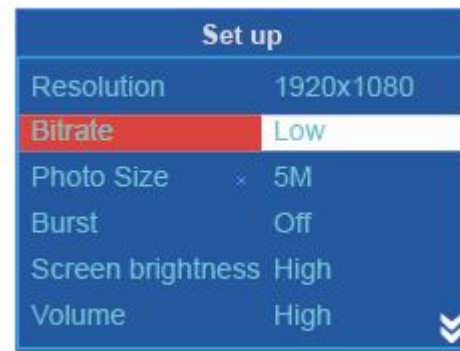

## Photo Size

After turned on, in the mode of framing and preview, press the menu button to enter into the interface of parameters setting and select size of photo. Press “OK” button to enter. The size has four levels of 5M、8M、12M、16M. Press “Up”, “Down” to select the suitable size of photo. And press “OK” after selecting. Press “Back” to return to the previous menu.

## Continuous Capture

Continuous capture means continuous photos shooting when press the camera button once in the mode of framing and preview or process of

recording.

After turned on, in the mode of framing and preview, press the menu button to enter into the interface of parameters setting and select options of Continuous Capture. Press “OK” button to enter. Continuous Capture has three options of Off, 3 and 5. Press “Up”, “Down” to select the suitable times for continuous capture. And press “OK” after selecting. Press “Back” to return to the previous menu.

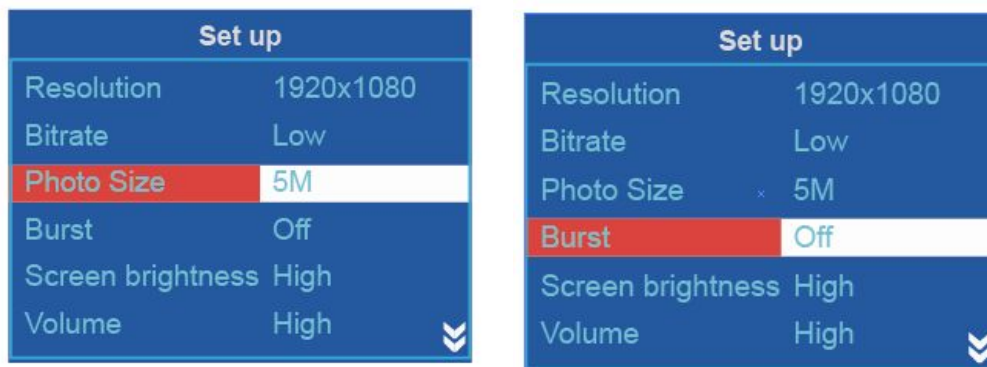

### **Sound volume**

After turned on, in the mode of framing and preview, press the menu button to enter into the interface of parameters setting and select options of Sound. Press “OK” button to enter. Sound has three options of High, Medium and Low. Press “Up”, “Down” to select the suitable sound. And press “OK” after selecting. Press “Back” to return to the previous menu.

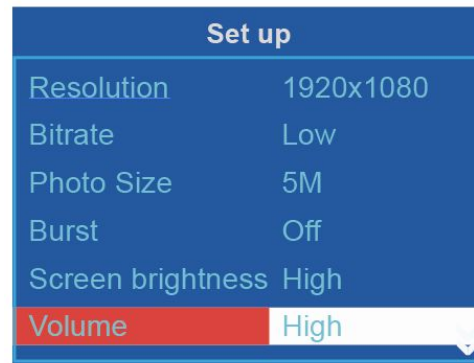

### Screen Brightness

Screen Brightness has three options of High, Medium and Low. Press “Up”, “Down” to select the suitable brightness of the screen. Factory Default is the brightest. And press “OK” after selecting. Press “Back” to return to the previous menu.

### Video segments

When capturing video, the product will automatically save a file every several minutes. There are 5, 10, 15, minutes, four modes. Press up or down button to select the appropriate mode, press OK button after selecting the OK , then return to the main menu.



## IR Switching

After turned on, in the viewfinder preview mode, press the Menu key to enter the parameter setting page, go to the IR switching mood which includes automatic and manual modes. Press the Up and Down keys to select the appropriate mode, press the Enter key after selecting the OK to return to the main menu.

## Motion detection:

There are two options to close and open. Press the Up and Down keys to select the appropriate mode, select OK When finished, press the ok key. Return to main menu.

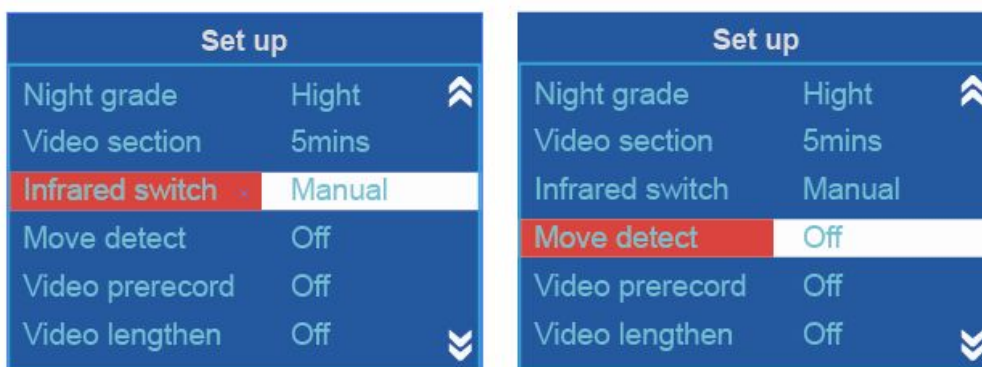

## Video pre-recording

There are two options to close and open. Press the Up and Down keys to select the appropriate mode, select OK When finished, press the ok key. Return to main menu.

## Video recording extension

There are close, 10s, 20s, 30s four options. Press the Up and Down

keys to select the appropriate mode, select OK. When finished, press the ok key. Return to main menu.

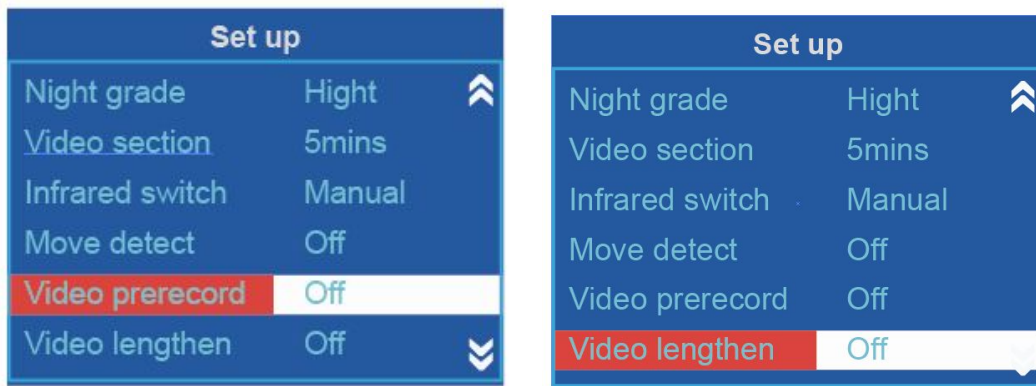

### Auto shutoff

Auto screen-off has four options of 1min, 3min and 5min and off. press “Up” or “Down”. Press “OK” button to select a proper mood. Then press “OK” after selecting. Press “Back” to return to the previous menu.

### Cycling video

During videoing process, when warned memory is full and the product can no longer continue to save the recorded time, open loop recording settings, then the system will automatically delete the first five minutes are recording, continue recording

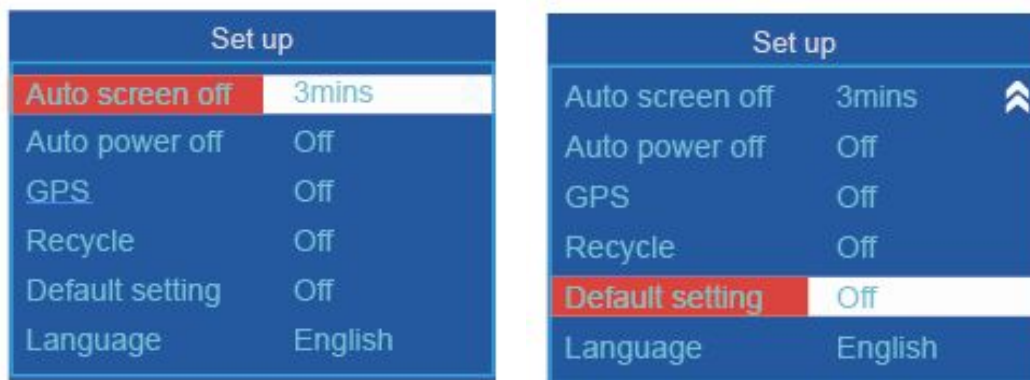

## Auto-power off

The user can set whether power off automatically if no operations after turned on and the time of auto power-off;

After turned on, in the mode of framing and preview, press the menu button to enter into the interface of parameters setting and select options of Auto Power-off through pressing “Up” or “Down”. Press “OK” button to enter

## GPS:

There are two options to close and open. Press the Up and Down keys to select the appropriate mode, select OK When finished, press the ok key. Return to main menu.

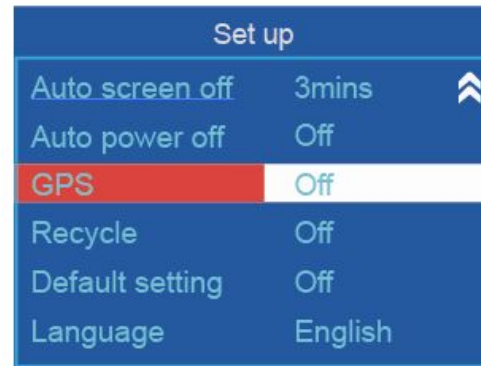
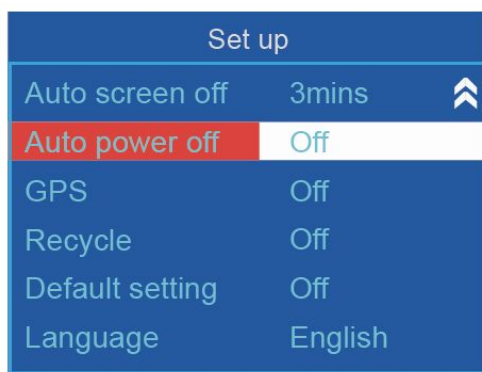

## System Reset:

There are two options to close and open. Press the Up and Down keys to select the appropriate mode, select OK When finished, press the ok key. Return to main menu

## Language

The equipment has two languages of Chinese and English. After



turned on, in the mode of framing and preview, press the menu button to enter into the interface of parameters setting and select options of Language through pressing “Up” or “Down”. Press “OK” button to enter. Press “Up” or “Down” buttons to select Chinese or English menu. And press “OK” after selecting. Press “Back” to return to the previous menu.

