





TruVision DVR 60 User Manual

Copyright	© 2011 UTC Fire & Security. All rights reserved.
Trademarks and patents	Interlogix, TruVision and logos are trademarks of UTC Fire & Security. Other trade names used in this document may be trademarks or registered trademarks of the manufacturers or vendors of the respective products.
Manufacturer	UTC Fire & Security Americas Corporation, Inc. 2955 Red Hill Avenue, Costa Mesa, CA 92626-5923, USA Authorized EU manufacturing representative: UTC Fire & Security B.V. Kelvinstraat 7, 6003 DH Weert, The Netherlands
Certification	
FCC compliance	Class A: This equipment has been tested and found to comply with the limits for a Class A digital device, pursuant to part 15 of the FCC Rules. These limits are designed to provide reasonable protection against harmful interference when the equipment is operated in a commercial environment. This equipment generates, uses, and can radiate radio frequency energy and, if not installed and used in accordance with the instruction manual, may cause harmful interference to radio communications. Operation of this equipment in a residential area is likely to cause harmful interference in which case the user will be required to correct the interference at his own expense.
ACMA compliance	Notice! This is a Class A product. In a domestic environment this product may cause radio interference in which case the user may be required to take adequate measures.
Canada	This Class A digital apparatus complies with Canadian ICES-003. Cet appareil numérique de la classe A est conforme à la norme NMB-0330 du Canada.
European Union directives	12004/108/EC (EMC directive): Hereby, UTC Fire & Security declares that this device is in compliance with the essential requirements and other relevant provisions of Directive 2004/108/EC.  2002/96/EC (WEEE directive): Products marked with this symbol cannot be disposed of as unsorted municipal waste in the European Union. For proper recycling, return this product to your local supplier upon the purchase of equivalent new equipment, or dispose of it at designated collection points. For more information see: www.recyclethis.info .  2006/66/EC (battery directive): This product contains a battery that cannot be disposed of as unsorted municipal waste in the European Union. See the product documentation for specific battery information. The battery is marked with this symbol, which may include lettering to indicate cadmium (Cd), lead (Pb), or mercury (Hg). For proper recycling, return the battery to your supplier or to a designated collection point. For more information see: www.recyclethis.info .
Contact information	www.interlogix.com www.utcssecurityproducts.eu
Customer support	www.interlogix.com/customer-support

Content

Chapter 1	Product introduction 1
	Product overview 1
	Features 2
Chapter 2	Installation 5
	Installation environment 5
	Unpacking the TVR 60 and its accessories 5
	HDD capacity 6
	Connecting devices to the rear panel 6
	IP cameras supported 7
	PTZ dome camera set up 8
	Wiring the keypad 12
	RS-485 ports 14
	RS-232 port 15
	Monitor connections 15
	Loop through 15
	Audio inputs and output 15
	Brackets 16
Chapter 3	Getting started 19
	Turning on and off the DVR 19
	Using the Setup Wizard 19
Chapter 4	Operating instructions 23
	Controlling the TVR 60 23
	Using the front panel 23
	Using the mouse 25
	Using the IR remote control 26
	Main menu overview 29
Chapter 5	Live mode 33
	Description of live mode 33
	Digital zoom 33
	Switching monitors 34
	Pop-up menus for mouse operation 35
	Viewing in full screen 36
	Viewing in multiscreen 36
	Sequencing cameras in live mode 37
	Cameo shortcuts 37
Chapter 6	Configuring the live mode display 39
	Configuring monitor and DVR options 39
	Configuring time and date 41

	Configuring display options	42
Chapter 7	Controlling a PTZ dome camera	47
	Configuring PTZ settings	47
	Pop-up menu for mouse operation	49
	Setting presets, preset tours and shadow tours	49
Chapter 8	Playing back a recording	55
	The playback control panel	56
	Playing back recorded video	56
	Exiting playback mode	63
Chapter 9	Archiving recorded files	65
	Archiving files	65
	Archiving video clips	68
	Managing backup devices	68
	Playing back archived files on a PC	69
Chapter 10	Using the Web browser	71
	Windows Vista and 7 users	71
	Accessing the Web browser	72
	Web browser overview	72
	Using the Web browser to configure the device	74
	Searching and playing back recorded video	75
	Searching for event logs	77
	Live dual streaming	77
	Controlling a PTZ dome camera in the Web browser	77
Chapter 11	Configuring recording settings	79
	Initializing recording settings	79
	Defining a recording schedule	81
	Protecting recorded files	83
	Configuring advanced HDD settings	84
Chapter 12	Configuring alarm settings	87
	Motion detection	87
	Setting up external alarms	92
	Triggering alarm outputs manually	94
	Setting up system notifications	95
	Detecting video loss	96
	Detecting video tampering	97
Chapter 13	Configuring network settings	99
	Configuring basic network settings	99
	Configuring the DDNS	100
	Configuring an NTP server	101
	Configuring a remote alarm host	101
	Configuring multicast	102

	Configuring the server and HTTP Ports	102
	Configuring e-mail settings	103
Chapter 14	Camera management	105
	Enabling or disabling analog cameras	106
	Configuring IP cameras	107
	Configuring the OSD settings	108
	Setting up privacy masking	109
	Adjusting video image settings	110
Chapter 15	HDD management	113
	Initializing HDDs	113
	Setting HDD groups	113
	Setting the HDD status	114
	Checking HDD status	116
	Configuring HDD alarms	117
Chapter 16	Configuring the DVR settings	119
	Changing the language	119
	Managing users	119
	Updating system firmware	125
	Restoring default settings	127
	Viewing system information	127
	Viewing system logs	127
Appendix A	Troubleshooting	129
Appendix B	Specifications	131
Appendix C	PTZ protocols	135
Appendix D	TVK-505U keypad	137
	Using a TVK-505U keypad	137
Appendix E	KTD-405 keypad	139
	Supported firmware	139
	Wiring the keypad	139
	Setting up the keypad to work with the TVR 60	140
	Operating the keypad	142
Appendix F	Camera matrix	149
Appendix G	Glossary	153
	Index	155
	Menu map	158

Chapter 1

Product introduction

Product overview

This is the TruVision DVR 60 User Manual for models:

Table 1: Product codes

Product code	EMEA	Americas
TVR-6016-500	Available	Unavailable
TVR-6016-1T	Available	Unavailable
TVR-6016-2T	Available	Available
TVR-6016-4T	Available	Available
TVR-6016-8T	Available	Available
TVR-6016-12T	Available	Available

Note: Some model versions are not available across all regions. EMEA product codes end with “EA” and are shipped with UK and European power cords.

The TruVision™ DVR 60 (TVR 60) is a full featured and scalable hybrid digital video recording system with the ability to store, display live, search, and transmit video from up to 24 analog or IP cameras.

Its dual streaming functionality allows the user to set up different settings for recording and streaming video in live mode.

TruVision DVR 60 can fully integrate with the license-free TruVision Navigator software, which is ideal for the most commercial applications. TVR 60’s easy and intuitive-to-use web browser interface enables remote configuration and secure viewing, searching, and playing back of video from computers connected via the Internet.

Features

This section describes the available TVR 60 features.

Compression

The TVR 60 supports the following video features:

- Scalable state-of-the-art hybrid H.264 video compression algorithm
- Supports both analog and IP cameras
- Real-time recording of 24 channels at 4CIF resolution
- Supports watermarking.

Storage

The TVR 60 supports the following storage features:

- Supports up to 12TB of onboard storage
- Supports configurable redundant recording
- Supports HDD designed for 24 × 7 operation and high write duty cycles
- Camera to HDD assignment for HDD data grouping

Recording and playback:

The TVR 60 supports the following video features:

- Real-time recording of 24 channels at 4CIF resolution
- Supported IP devices: TruVision H.264 MPX and SD IP cameras, UltraView Encoder 10, UltraView IP, CamPlus2 IP and Panasonic IP cameras
- Dual streaming functionality allows the use of different settings for recording and streaming video
- PTZ and dome camera control via mouse, front panel joystick and IR remote controller
- E-mail notification upon alarm with attached images and health notifications

Network

The TVR 60 supports the following video features:

- Networkable via Ethernet (TCP/IP) for remote monitoring, searching, playback, archiving, configuration, alarm notifications and firmware upgrades
- Ability to fully integrate with the license-free TruVision Navigator software and TVRmobile software.
- Built-in Web server

Other:

The TVR 60 supports the following additional features:

- Auto-detect video (PAL or NTSC) on startup
- Multiple control inputs: front panel, mouse, IR remote control, and keyboard
- Supports KTD-405 / TVK-505U keypad control
- Multi-language support
- Triple monitor support - Monitor A, monitor B and spot monitors

Chapter 2

Installation

Installation environment

When installing your product, consider these factors:

- Ventilation
- Temperature
- Moisture
- Chassis load

Ventilation: Do not block any ventilation openings. Install in accordance with the manufacturer's instructions. Ensure that the location planned for the installation of the unit is well ventilated.

Temperature: Consider the unit's operating temperature (0 to 40°C, 32 to 104°F) and noncondensing humidity specifications (10 to 90%) before choosing an installation location. Extremes of heat or cold beyond the specified operating temperature limits may reduce the life expectancy of the TruVision DVR 60. Do not install the unit on top of other hot equipment. Leave 44 mm (1.75 in.) of space between rack-mounted TruVision DVR 60 units.

Moisture: Do not use the unit near water. Moisture can damage the internal components. To reduce the risk of fire or electric shock, do not expose this unit to rain or moisture.

Chassis: Equipment weighing less than 15.9 kg (35 lb.) may be placed on top of the unit.

Unpacking the TVR 60 and its accessories

When you receive the product, check the package and contents for damage, and verify that all items are included. There is an item list included in the package. If any of the items are damaged or missing, please contact your local supplier.

Items shipped with the product include:

- IR (infrared) remote control
- Two AAA batteries for the remote control
- AC power cords (US, Europe, UK)
- USB mouse
- DVR
- Video loop through cable
- *TruVision DVR 60 Quick Start Guide*
- *TruVision DVR 60 User Manual (on CD)*

HDD capacity

Storage capacity for the TVR 60 varies depending on the model. Refer to Table 2 below for more information.

Table 2: TruVision DVR 60 model types

Model number	Description
TVR-6016-500EA	TruVision DVR Model 60, 16 ch, 500 GB
TVR-6016-1TEA	TruVision DVR Model 60, 16 ch, 1 TB
TVR-6016-2T(EA)	TruVision DVR Model 60, 16 ch, 2 TB
TVR-6016-4T(EA)	TruVision DVR Model 60, 16 ch, 4 TB
TVR-6016-8T(EA)	TruVision DVR Model 60, 16 ch, 8 TB
TVR-6016-12T(EA)	TruVision DVR Model 60, 16 ch, 12 TB

Connecting devices to the rear panel

Figure 1 below shows the rear panel connections and describes each connector on a typical TVR 60 digital video recorder. Details may vary for specific models.

Before powering up the DVR, connect the cameras and a main monitor for basic operation.

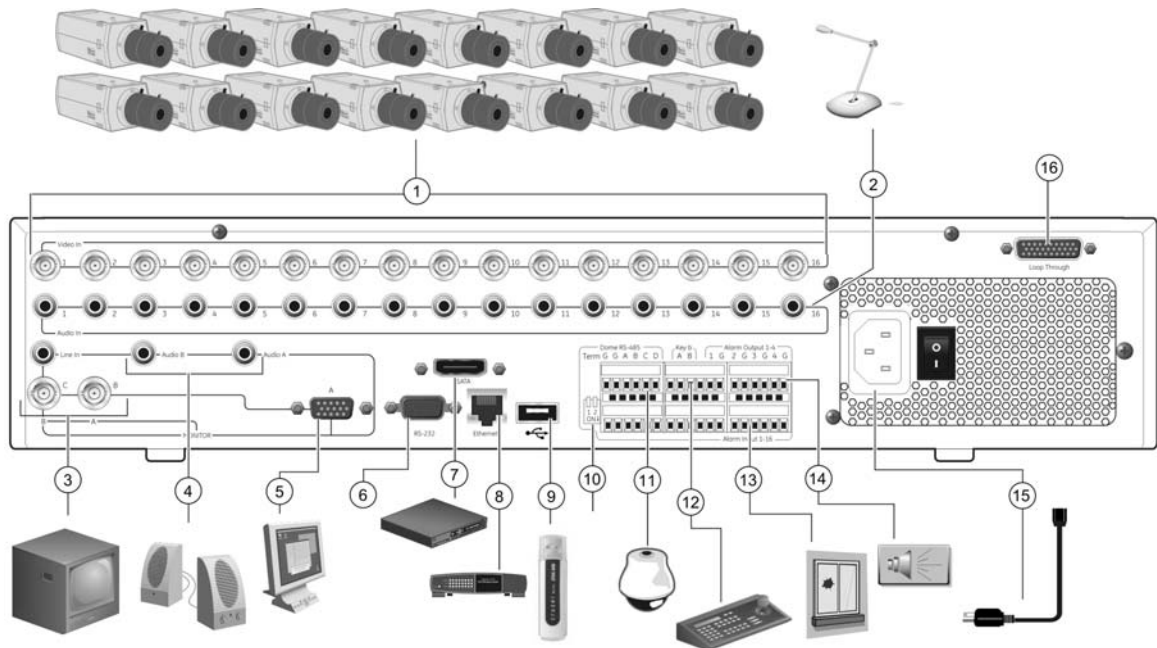
Figure 1: Rear panel connections

1. Connect up to 16 analog cameras to BNC connectors.
2. Connect to audio inputs (available for each camera) to RCA connectors.
3. Connect up to two CCTV monitors (monitors B and C).
4. Connect to speakers for audio output.
5. Connect VGA monitor (default main monitor).
6. For future use.
7. Connect to an eSATA device.
8. Connect to a network.
9. Connect to USB devices such as a mouse. USB CD/DVD burner and USB HDD are not supported.
10. Terminate the line to the dome cameras using this RS-485 switch. Default is Off.
11. Connect to a PTZ control.
12. Connect to a keypad (KTD-405 shown)
13. Connect up to 16 alarm input cables to relay outputs.
14. Connect up to four NO/NC alarm relay outputs.
15. Connect to a power cord.
16. Loop through for up to 16 analog cameras (see item 1).

IP cameras supported

The TVR 60 supports the following IP cameras with their resolutions and maximum bit rates. See Table 3 below.

Table 3: IP cameras supported

Supported cameras	Resolutions supported	Maximum bit rate - Main stream	Maximum bit rate - Sub stream
TruVision 2MPX camera	UXGA, HD720P, 4CIF, 2CIF, CIF, QCIF	2Mbps	1Mbps
TruVision 1.3MPX camera	HD720P, 4CIF, 2CIF, CIF, QCIF	2Mbps	1Mbps
UltraView encoder	4CIF, 2CIF, CIF, QCIF	1.7Mbps	1Mbps
UltraView IP box camera	4CIF, 2CIF, CIF, QCIF	1.7Mbps	1Mbps
UltraView IP dome camera	4CIF, 2CIF, CIF, QCIF	1.7Mbps	1Mbps

Supported cameras	Resolutions supported	Maximum bit rate - Main stream	Maximum bit rate - Sub stream
UltraView IP PTZ camera	4CIF, 2CIF, CIF, QCIF	1.7Mbps	1Mbps
CamPlus2 IP camera	VGA, QVGA	2Mbps	N/A
Panasonic IP camera	VGA, QVGA	2Mbps	N/A

PTZ dome camera set up

Use the USB mouse provided or the optional keypad for local telemetry control. If using the TVR 60 over a network, use the web browser to control the PTZ dome cameras or TruVision Navigator.

See Appendix C “PTZ protocols” on page 135 for the supported protocols.

Each PTZ camera must be set up individually. For information on configuring PTZ dome camera settings, see Chapter 7 “Controlling a PTZ dome camera” on page 47.

Connecting a TVR 60 to a PTZ dome camera and a keypad

Use the input/output box that is supplied with the keypad to connect a keypad to the TVR 60. The keypad can be connected to a PTZ camera for local control or for control over the network.

See Figure 2 on page 9 for the preferred setup. Any PTZ dome camera can be controlled as the DVR is doing the PTZ protocol translation. However, this setup provides only limited dome configuration.

Figure 2: Connecting a keypad to the TVR 60 for control of a PTZ dome camera over the network

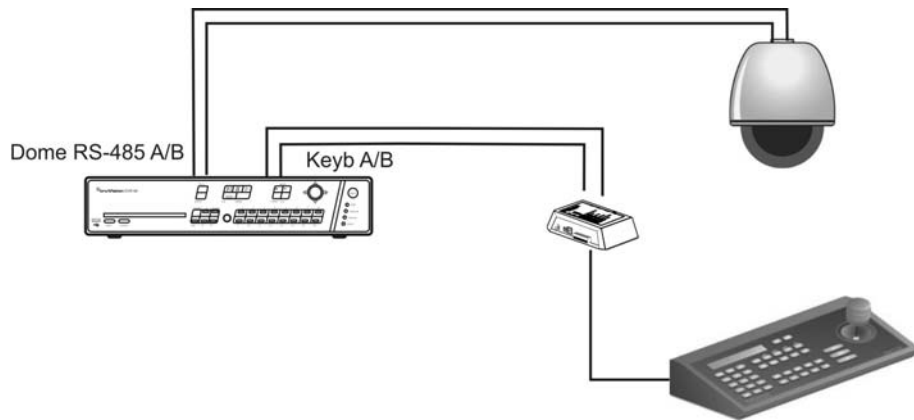

Configuring the PTZ protocols for Interlogix cameras

Before the PTZ dome cameras are assembled in their housings, set their protocol and address DIP switches for the TVR 60. See Table 4 below for different Interlogix PTZ dome camera settings.

If you are using PTZ dome cameras from another company, please refer to their configuration instructions.

Table 4: PTZ protocols for Interlogix cameras

Camera	Switch setting
TruVision Mini PTZ 12X: Indoor Dome	Protocol DIP switches: 000000 <hr/> RS-485 communication DIP switches: 0000000000 <hr/> Camera ID DIP switches: Select the camera ID DIP switch address as required

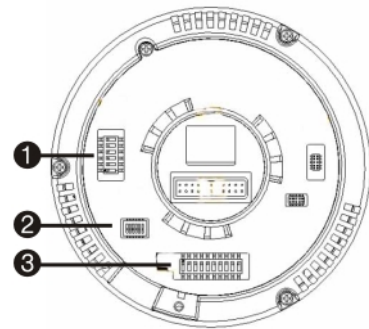

1. Protocol DIP switches
2. RS-485 communication DIP switches
3. Camera ID DIP switches

RS-485 data connector:

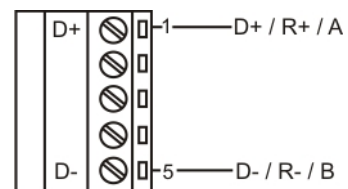

Camera	Switch setting
TruVision Mini PTZ 12X: Outdoor Dome	Protocol DIP switches: 000000
	RS-485 communication DIP switches: 0000000000
	Camera ID DIP switches: Select the camera ID DIP switch address as required.

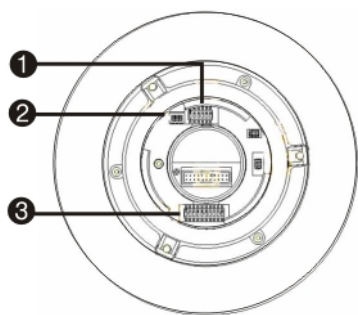

- 1. Protocol DIP switches
- 2. RS-485 communication DIP switches
- 3. Camera ID DIP switches

RS-485 data connector:

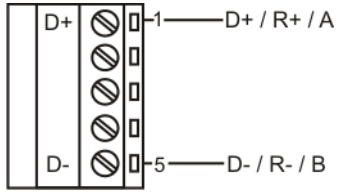

TruVision Dome 16X PTZ	Protocol switches: 0111
	Address switches: Select the camera ID DIP switch address as required.
	Baud rate: 0000

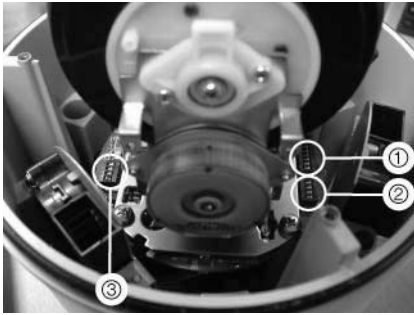

- 1. Address switches; 2. Baud switches;
- 3. Protocol switches

RS-485 data connector:

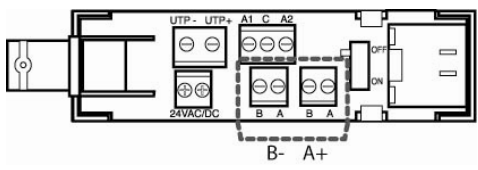

Camera	Switch setting
CyberDome	<p>Protocol switches: NA</p> <p>Address switches: Select the camera ID DIP switch address as required.</p>

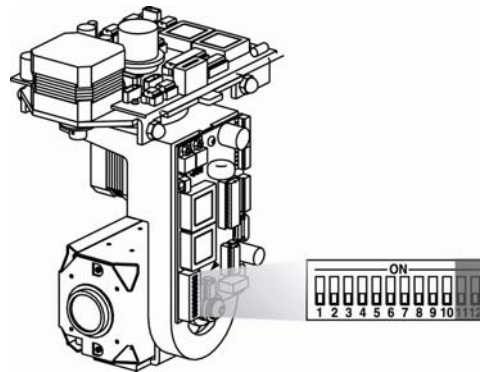

RS-485 data connector:

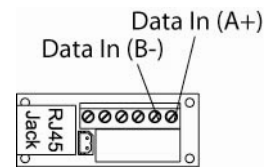

UltraView PTZ	<p>Protocol switches: 01000</p> <p>Address switches: Select the address switch address as required.</p>
---------------	---

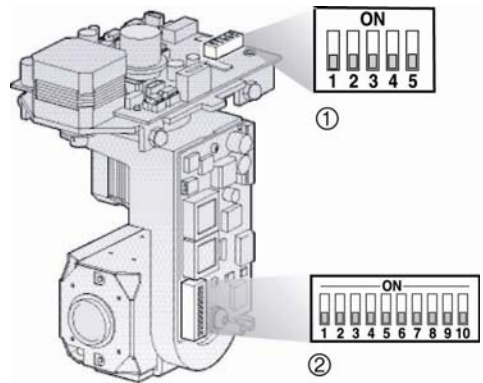

1. Protocol switches; 2. Address switches

RS-485 data connector:

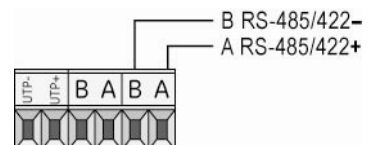

Camera	Switch setting
Legend	<p>Protocol switches: 1</p> <p>Address switches: Select the camera ID DIP switch address as required.</p>

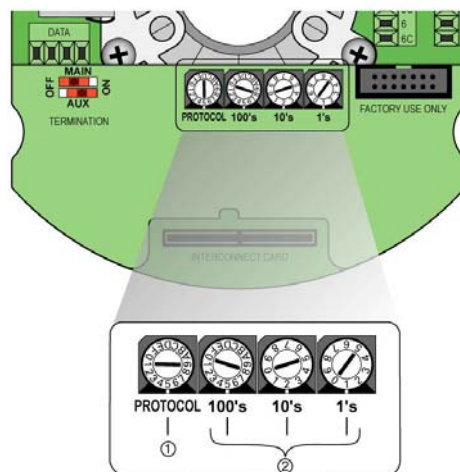

RS-485 data connector:

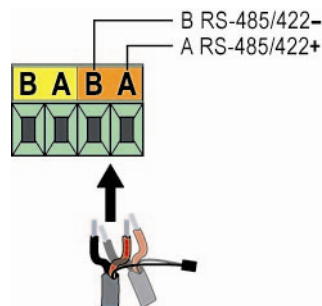

Wiring the keypad

The keypad uses RS-485 simplex wiring. The signal is transferred by a single twisted pair line. A shielded STP CAT5 network cable is recommended. Ground one end of the cable, either the first or last device on the RS-485 line.

The maximum number of devices that can be installed in one bus is 255, with a maximum cable length of 1200 m. The cable length can be expanded using a signal distributor.

Both the first and the last device in series should be terminated with 120 Ohm resistance to minimize line reflections. See Figure 3 on page 13.

Figure 3: RS-485 bus serial wiring (KTD-405 keypad shown)

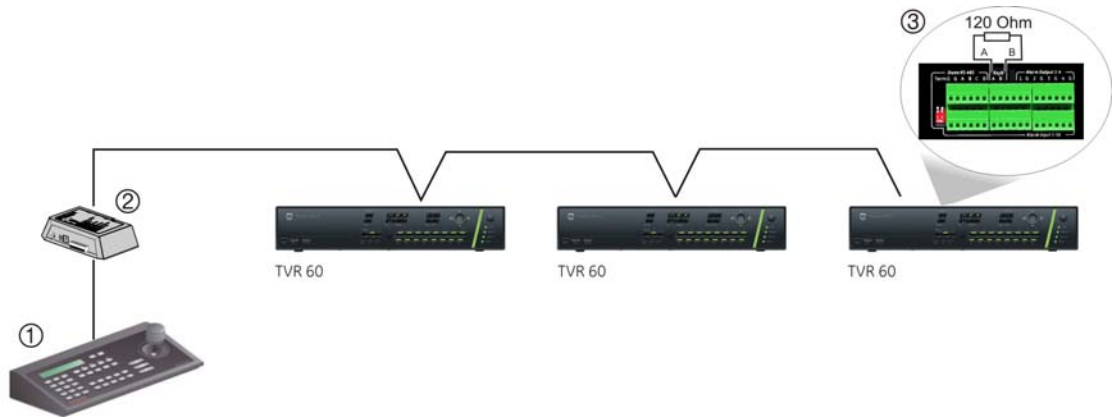

- 1. Keypad
- 2. I/O box

3. See section "RS-485 ports" on page 14

Use an RS-485 signal distributor for a star wiring configuration. See Figure 4 below.

Figure 4: Star wiring with RS-485 signal distributor

Correct

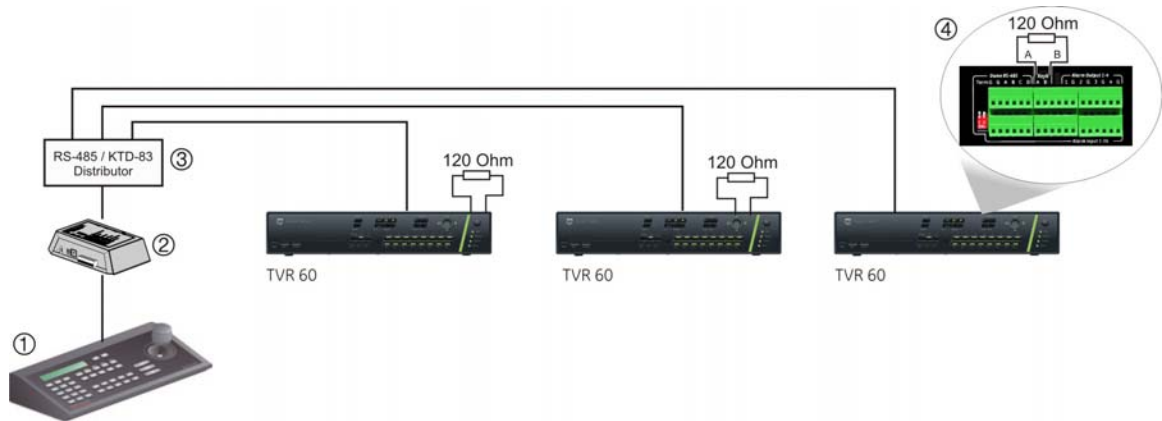

- 1. Keypad
- 2. I/O box

3. RS-485/KTD-83 distributor
4. See section "RS-485 ports" on page 14

Incorrect

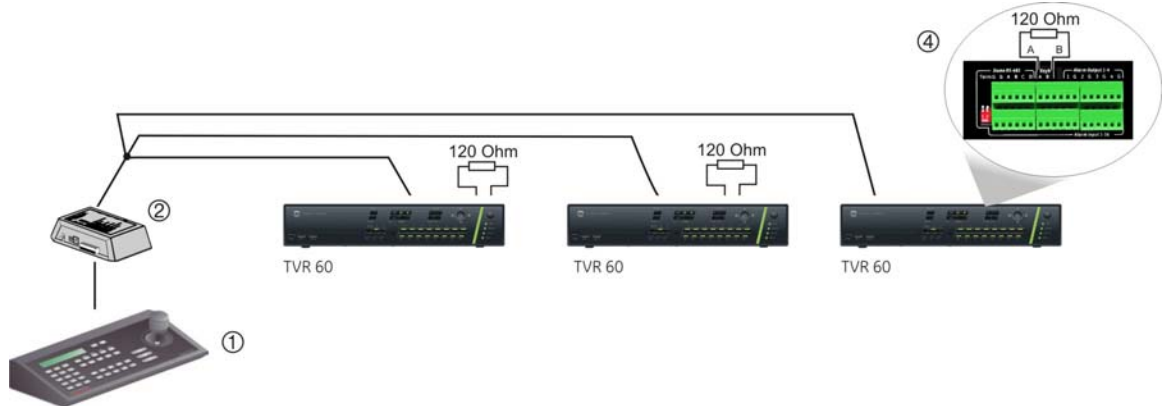

Use an RS-485/KTD-83 signal distributor to increase the maximum number of devices on the bus as well as the total range. Each distributor output provides another RS-485 bus, extending the output an additional 1200 m. Up to 31 TVR 60s can be connected to each output. See Figure 5 below.

Figure 5: Expanding the system with an RS-485 signal distributor

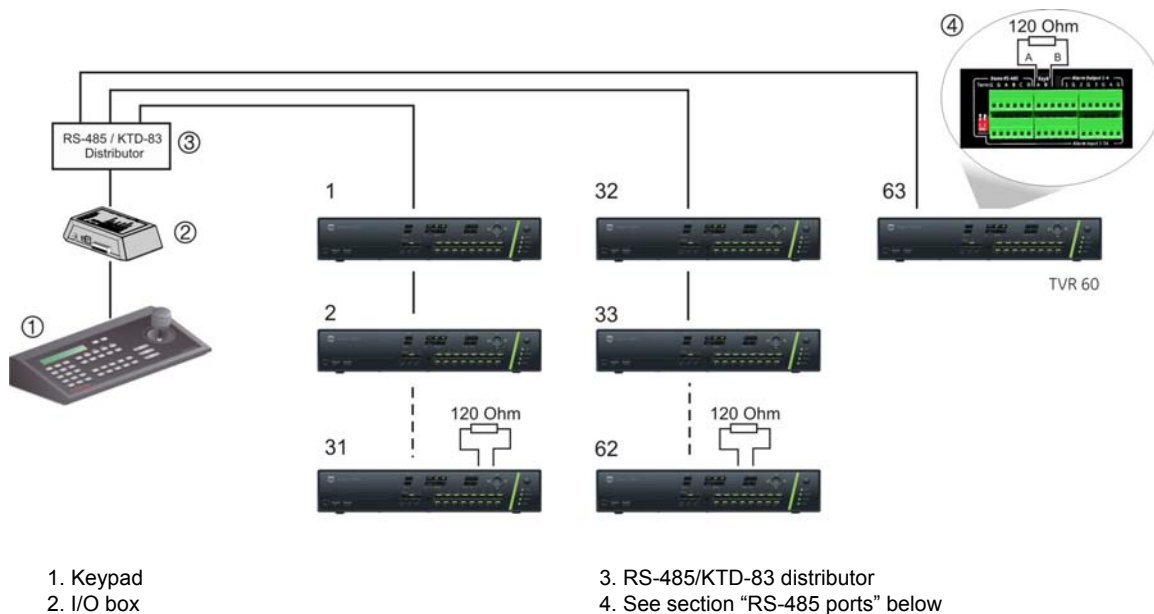

Caution: Most signal distributors are unidirectional. This means that the signal only flows from the input towards the outputs. Consequently it is not possible to connect several keypads.

See section "RS-485 ports" below to configure the RS-485 port communication settings.

RS-485 ports

There are two RS-485 ports on the rear panel of the TVR 60. See Figure 6 on page 15 for the serial pin outs.

- **Dome RS-485:**
 - Term G: Termination of RS-485 bus
 - G: Ground
 - A and B: Connect pan, tilt, zoom control of PTZ dome cameras. A = +, B = -
 - C and D: Not used
- **Keyb:** Connect the keypad.

Figure 6: RS-485 pins

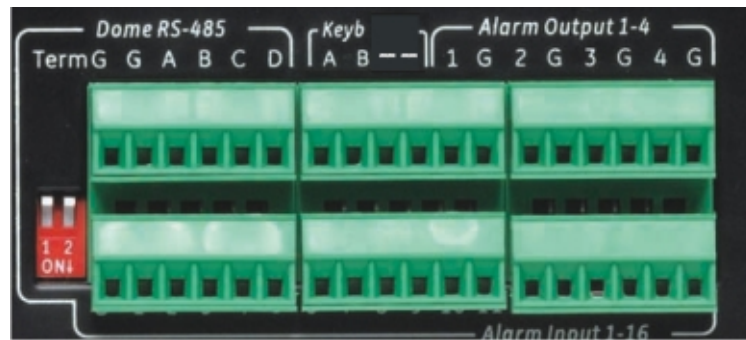

RS-232 port

The RS-232 port will be available for future use to connect CBR-PB3-POS (point-of-sale) and ATM devices to the TVR 60.

Monitor connections

Connect the unit to the monitors via 75-ohm video coaxial cables with BNC connectors. The unit provides a 1 Vpp CVBS signal. See Figure 1 on page 7 for connecting a monitor to a TVR 60.

The TVR 60 supports up to 1280 × 1024 / 60 Hz resolution in VGA. The monitor resolution should be at least 800 × 600. Adjust your monitor accordingly to this resolution.

Loop through

You can loop through the analog cameras to equipment such as a matrix, monitors or a second DVR. There are 16 numbered loop-through BNC outputs. See Figure 1 on page 7.

Audio inputs and output

The unit is equipped with 16 audio inputs and two audio outputs. Both the audio output and the audio inputs are line-level. Each 16 audio input is associated with one of the 16 cameras.

Audio input	RCA jack, 315 mV, 40k Ohms. Unbalanced
Audio output	RCA jack, 315mV, 600 Ohms. Unbalanced

Note: Line-level audio requires amplification.

Brackets

The DVR is easily rack-mountable with the purchase of the TVR-RK-1 rack-mount kit. See Figure 7 below. Contact your local supplier to order it.

Figure 7: Rack mount installation

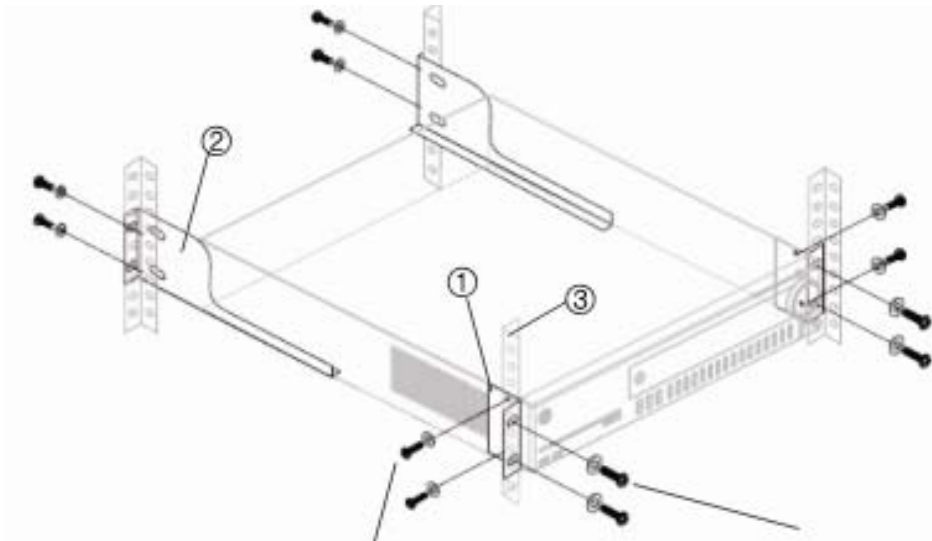

Attach small front rack ears to the unit
(screws supplied)

Attach DVR to front rails
(screws not included)

To install the racks:

1. Attach the two small front-rack mount ears to the DVR (screws supplied).
2. Attach the two large rear support brackets (not supplied) to the rear rails.
3. Attach the DVR to the front rails (screws not supplied).

Caution:

Do not rack mount the TVR 60 without the rear rails installed. Failure to install the rear rails can damage the DVR.

- **Elevated Operating Ambient** - If installed in a closed or multi-unit rack assembly, the operating ambient temperature of the rack environment may be greater than room ambient. Therefore, consideration should be given to installing the equipment in an environment compatible with the maximum ambient temperature (40°C) specified by the manufacturer.
- **Reduced Air Flow** - Installation of the equipment in a rack should be such that the amount of air flow required for safe operation of the equipment is not compromised.
- **Mechanical Loading** - Mounting of the equipment in the rack should be such that a hazardous condition is not achieved due to uneven mechanical loading.

-
- **Circuit Overloading** - Consideration should be given to the connection of the equipment to the supply circuit and the effect that overloading of the circuits might have on overcurrent protection and supply wiring. Appropriate consideration of equipment nameplate ratings should be used when addressing this concern.
 - **Reliable Earthing** - Reliable earthing of rack-mounted equipment should be maintained. Particular attention should be given to supply connections other than direct connections to the branch circuit (e.g. use of power strips).
-

Chapter 3

Getting started

Turning on and off the DVR

Before turning the power on connect at least one monitor to the video out or the VGA interface. Otherwise, you will not be able to see the user interface and operate the device. Also connect at least one camera.

The TVR 60 auto-detects the video mode (PAL or NTSC) on startup.

The TVR 60 is equipped with a universal power supply that will auto-sense 110/240 V, 60/50 Hz.

Note: It is recommended that an uninterruptible power supply (UPS) is used in conjunction with the device.

To turn on the DVR:

Turn on the DVR using the power switch on the rear panel. Once the TVR 60 is powered up, the indicator bar on the front panel will light up green. All connected cameras are displayed on-screen. The TVR 60 automatically begins recording.

To turn off the DVR:

Turn off the DVR using the power switch on the rear panel.

Using the Setup Wizard

The TVR 60 has an express installation wizard that lets you easily configure basic DVR settings when first used. It configures all cameras simultaneously. The configuration can then be customized as required.

By default the Setup Wizard will start once the DVR has loaded, as shown in Figure 8 on page 20. The Setup Wizard will walk you through some of the more important settings of your DVR.

Note: After the system is set up, you can uncheck the “Start wizard” box. The setup wizard is then no longer started automatically.

Any changes you make to a setup configuration screen are saved when you exit the screen and return to the main eZ Setup screen.

Note: The TVR 60 firmware supports over 16 languages.

Figure 8: Setup Wizard screen



To quickly set up the TVR 60:

1. Connect all the devices required to the rear panel of the TVR 60. See Figure 1 on page 7.
2. Turn on the unit using the power switch on the rear panel. After the boot up screen, the TVR 60 displays video images on-screen.
3. Select the preferred language for the system.
4. In the eZ Setup screen, click **Next**. The User Permission screen appears.
5. **Administrator configuration:**

Navigate to the Admin Password edit box and click the edit box with the mouse, or press Enter on the front panel or remote control, to display the virtual keyboard. Enter the default admin password, 1234.

Note: You must enter an admin password.

Caution: It is strongly recommended that you change the password of the administrator. Do not leave 1234 as the default password. Write it down in a safe place so that you do not forget it.

Click **Next**. You are then asked if you want to enter the HDD Management screen.

6. **HDD management:**

Click **Enter** to open the HDD Management screen and configure your HDD settings as required.

You can group HDDs and assign cameras to a group. See “Setting HDD groups” on page 113. You can also set up a drive for redundant recording. See “Setting the HDD to redundancy” on page 115.



After setting your HDD settings, click **OK** and then **Next**. You are then asked if you want to enter the Record Settings screen.

7. Recording configuration:

Click **Enter** to open the Record Settings screen.



Under the Recording tab, select a camera and specify the camera settings.

Click the Schedule tab.



Click **Edit**.

Check both the “Enable Schedule” and “All Day” checkbox. This enables the recording schedule. The DVR will record continuously all day for the whole week.



Click **OK** to return to the Schedule tab. To copy the schedule to another camera, select the camera or select “All” under Copy To and click the Copy button.

Click **OK** and then **Next**. You are then asked if you want to enter the Network Settings screen.

8. Network configuration:

Click **Enter** to open the Network Settings screen and define your network settings such as the IP address, subnet mask and default gateway.



Click **OK** to return to the eZ Setup screen.

- When all the required changes have been entered, click **Finish** to exit the Setup Wizard. The TVR 60 is now ready to use.

Chapter 4

Operating instructions

Controlling the TVR 60

There are several ways to control the TVR 60:

- Front panel control
- Mouse control
- IR remote control
- KTD-405 / TVK-505U keypad control (see appendix)
- Web browser control (see Chapter 10 “Using the Web browser” on page 71)

You can use your preferred control method for any procedure, but in most cases we describe procedures using mouse terminology. Optional control methods are given only when they differ substantially from mouse control methods.

Using the front panel

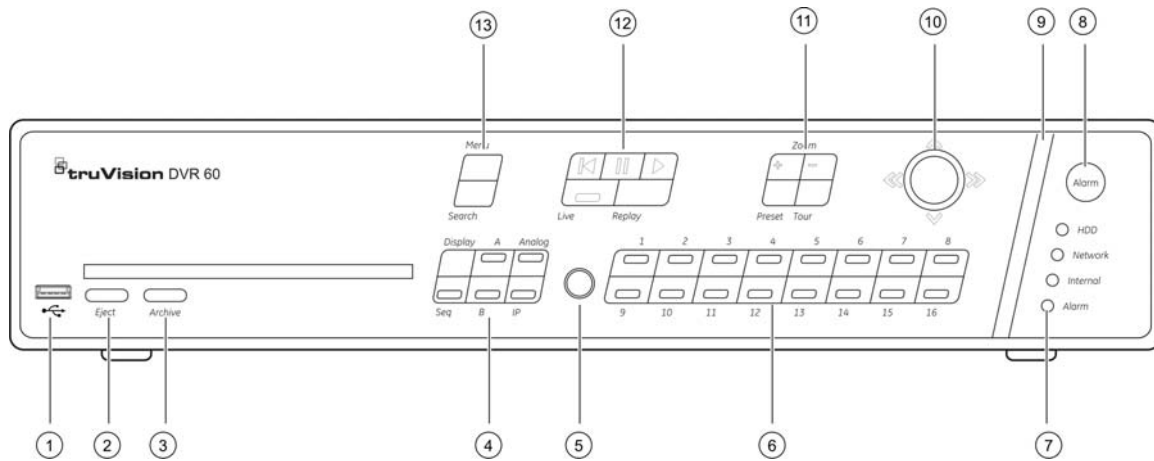

The buttons on the front panel control can be used to operate many, but not all, of the main functions of the TVR 60 or the DVR functions. The LED indicators light up or flash to alert you of various conditions. The functions available can be limited by setting passwords. See Figure 9 on page 24 for more information.

Figure 9: Front panel



The controls on the front panel include:

Item	Name	Description
1.	USB port	Universal serial bus (USB) port for additional devices such as USB mouse and USB hard disk drive (HDD)
2.	Eject	Ejects CD/DVD disc.
3.	Archive	Press once to enter quick archive mode. Press twice to start archiving.
4.	Display buttons	Display: Toggles through the various multiscreens: full, quad, 1+5, 1+7, 9, and 16. Sequence: Starts/stops sequencing in live mode. A: Selects monitor VGA/A in live mode B: Selects monitor A/B in live mode Analog: Displays the analog cameras IP: Displays the IP cameras
5.	IR receiver	Receiver for IR remote
6.	Numeric buttons	Switch between different cameras in live, PTZ control or playback modes.
7.	Status LEDs	HDD: Green indicates the DVR is working correctly. Red indicates a fault. Network: Green indicates the network is working correctly. Red indicates a fault or no network connection. Internal: Green indicates the Watchdog is working correctly. Red indicates that the Watchdog is reporting a fault. Alarm: Green indicates no external alarm. Red indicates an external alarm status or motion.
8.	Alarm button	Use to manually acknowledge an alarm.
9.	Alarm indicator bar	Blinking red indicates that there is an alarm.

Item	Name	Description
10.	Joystick	<p>Use to select options in a menu and to control playback. Press for Enter. Press LED arrows are lit when the jog is active.</p> <p>Live mode: Enter PTZ mode.</p> <p>Menu mode: Move the joystick left/right and up/down to position cursor in menu screen. Press for Enter.</p> <p>Playback mode: Move the joystick left/right and up/down to position cursor in menu screen. Press for Enter.</p> <p>PTZ mode:</p> <p>Rotate the joystick to control the movement of the PTZ dome camera:</p> <ul style="list-style-type: none"> - Move left: Decrease speed. - Move right: Increase speed. - Move up: Jump forwards 30 seconds. - Move down: Jump backwards 30 seconds.
11.	PTZ buttons	<p>Zoom: Use + and – for digital zoom.</p> <p>Preset: Call up preprogrammed preset positions.</p> <p>Tour: Call up preprogrammed shadow tours.</p>
12.	Playback buttons	<p>: Jump back to the oldest available video and starts the playback.</p> <p>: Pause playback.</p> <p>: Instantly playback the currently selected file. Default time is 1 minute.</p> <p>Live: Switch to live mode.</p> <p>Replay: Replay the current file in playback Starts at the beginning of the file.</p>
13.	Menu and Search buttons	<p>Menu: Enter main menu.</p> <p>Search: Enter advanced search menu.</p>

Using the mouse

The USB mouse provided with the TVR 60 can be used to operate all the functions of the DVR, unlike the front panel which has limited functionality. The USB mouse lets you navigate and make changes to settings in the user interface.

Connect the mouse to the TVR 60 by plugging the mouse USB connector into the USB port on the rear panel. The mouse is immediately operational and the pointer should appear.

Note: Use a USB 1.1 or higher mouse.

Move the pointer to a command, option, or button on a screen. Left-click the mouse to confirm a selection.

You can purchase a spare mouse by ordering part number TVR-MOUSE-1 TruVision™ DVR Model 40/60 Mouse.

To use a USB mouse:

1. Plug USB mouse into one of the USB ports on the front or rear panel of the DVR.
2. The mouse should automatically be detected.

See Table 5 below for a description of the mouse buttons.

Table 5: Mouse buttons

Item	Description
Left button	<p>Single-Click: Select a component of a menu, such as a button or an input field. This is similar to pressing the Enter button on the remote/front panel controls.</p> <p>Double-Click: Switch between single screen and multi-screen mode in live/ playback mode.</p> <p>Click and Drag: Click and drag the left mouse button to setup the alarm areas.</p>
Right button	<p>Single-Click: Shows pop-up menu</p>
Scroll-wheel	<p>Scroll Up: In Live mode, scrolling up will switch to the previous screen. In Menu mode, it will move the selection to the previous item.</p> <p>Scroll Down: In live mode, scrolling down will switch to the next screen. In Menu mode, it will move the selection to the next item</p>

Using the IR remote control

The TVR 60 is supplied with an infra red (IR) remote control unit. Like the mouse, it can be used to operate all of the main functions of the TVR 60.

The IR remote control can be programmed with a unique device ID address so that the controller will only be able to communicate with DVRs with that address. No programming is necessary if using a single TVR 60.

The device ID address only applies when using a remote control and not when using a keypad.

You can purchase a remote control by ordering part number TVR-REMOTE-1 TruVision™ DVR Model 40/60 IR Remote Control.

Figure 10: IR remote control

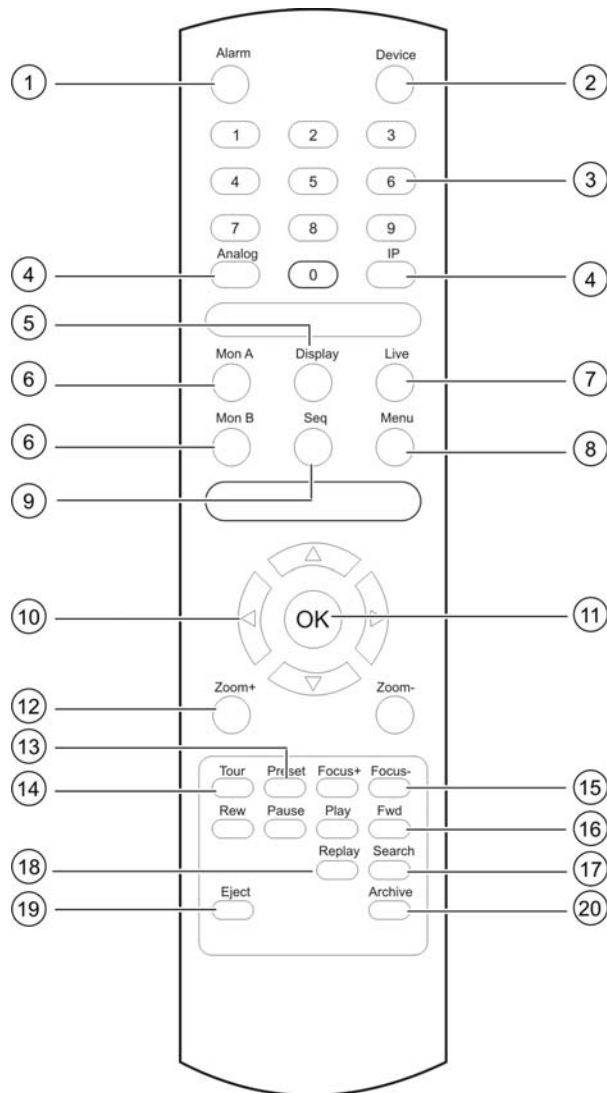

Item	Description
1. Alarm	Acknowledge an alarm.
2. Device	Enable/disable the IR remote control to control the TVR 60.
3. Numeric buttons	Select a camera, and enter a number in a menu option.
4. Analog and IP	Analog and IP buttons have the same function as on the front panel to select between analog and IP cameras.
5. Display	Toggle between the multiscreen views.
6. Mon A and Mon B	Toggle between monitors A and B.
7. Live	Return to live mode.
8. Menu	Activate the main menu.
9. Seq	Start /stop sequencing.
10. <, >, ^, v	In Menu mode: Use left or right arrow buttons to select and up or down arrow buttons to edit entry. In PTZ mode: Use to control PTZ. In Playback mode: Use to control playback speed.
11. OK	Confirm selection.
12. Zoom + and -	Use to control zoom of camera lens.
13. Preset	Enter preprogrammed three-digit code to call up a preset.

Item	Description
14. Tour	Enter preprogrammed three-digit code to call up shadow tour.
15. Focus + and -	Use to control focus of camera lens.
16. Playback control	Use to control playback (Rewind, Pause, Play, and Fast Forward).
17. Search	Open the Search menu.
18. Replay	Replay the selected file from the beginning.
19. Eject	Eject the CD or DVD disk.
20. Archive	Press once to enter quick archive mode. Press twice to start archiving.

Aim the remote control at the IR receiver located at the front of the unit to test operation.

To connect the remote control to the TVR 60:

1. Press the **Menu** button on the remote control or front panel or right-click the mouse and select the **Menu** button. The main menu screen appears.
2. Click the **Display** icon.
3. Click the Monitor tab. The Monitor screen appears.
4. Check and remember the DVR device address value. The default value is 255. This device address is valid for all IR controls.

Note: The device address does not apply to keypads.

5. On the remote control press the **Device** button.
6. Enter the device address value. It must be the same as that on the TVR 60.
7. Press the **ENTER** button on the remote or front panel.

To place batteries into the IR remote control:

1. Remove the battery cover.
2. Insert the batteries. Make sure that the positive (+) and negative (-) poles are correctly placed.
3. Replace the battery cover.

Troubleshooting the remote control:

If the IR remote control is not functioning properly, perform the following tests:

- Check the battery polarity.
- Check the remaining charge in the batteries.
- Check that the IR remote control sensor is not masked.

If the problem still exists, please contact your administrator.

Main menu overview

The TVR 60 has an icon-driven menu structure that allows you to configure the unit's parameters. Figure 11 below shows the TVR 60 main menu screen. Each command icon displays a screen that lets you edit a group of TVR 60 settings. Most screens are available only to system administrators.

You must be in live mode to access the main menu.

The currently selected command icon is highlighted in green.

Figure 11: Main menu

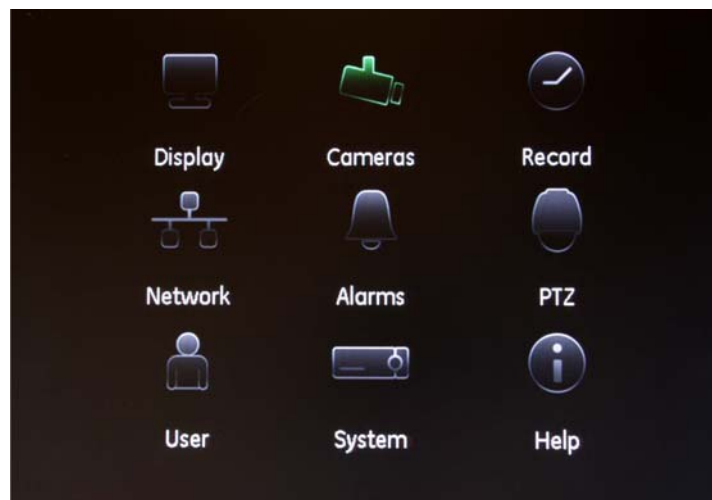

Table 6: Description of the menu commands and options

Main menu command icon	Description
Display	Configures display settings including dwell time, schedule, language and display formats.
Cameras	Configures camera settings including motion detection, video image adjustments, camera title, and copy settings to other cameras. See
Record	Configures recording settings including recording schedules, record quality, and record mode.
Network	Configures standard network settings including IP address, e-mail notifications, DDNS setup, and advanced network settings.
Alarms	Configures alarm settings including alarm input, relay output, video loss, remote alert, pre-alarm and post-alarm seconds.
PTZ	Configures PTZ settings.
User	Configures users, passwords, and access privileges.
Systems	Configures system settings including system date and time, audio output, device name, RS-485 settings, RS-232 settings, firmware upgrade, hard drive settings, boot log, and shutdown.
Help	Provides reference information to the various toolbars, menus, and keys within the interface.

To access the main menu:

1. Press the **Menu** button on the remote control or front panel or right-click the mouse and select the Menu button. The main menu screen appears.





Press **Exit** in the main menu screen to return to live mode.

Navigating through a dialog screen

Use the mouse to select any option or button on the screen. You can also use the joystick (Up, Down, Left, or Right) on the front panel to navigate through the options and press Enter to select. Press Menu to return to configuration category and icon.

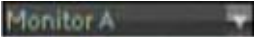
Changes to screen settings can be entered in various ways as shown in Table 7 below.

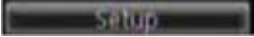
Table 7: Types of control

Control	Function	Description
	Edit box	An edit box lets you type characters to set the value of an option, such as a camera name. You must be in edit mode before you can enter a value. Click the box and a virtual keyboard will appear to enter alphanumeric characters. See “Using the virtual keyboard” below.
	List box	Provides more than two values for the option. Only one of them can be selected. Click the scroll arrows at the right-hand side of the box to scroll through the possible values. Click an option to then select it.
	Check box	Provides two values: ✓ indicates enabled and a blank box indicates disabled. Click the check box.
	Button	Executes the function displayed on the button. Click the button.
	Bar	Lets you adjust the scale of a value. Click and hold the cursor. Adjust its position left or right along the bar.

Using the virtual keyboard

A keyboard will appear on-screen when you need to enter characters in a screen option. Click a key to input that character.

Figure 12: The virtual keyboard

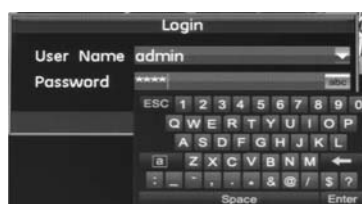

Description of the keys in the virtual keyboard:



Switch to Lowercase: Switch to lowercase input.



Switch to Uppercase: Switch to uppercase input.



Backspace: Delete the character in front of the cursor.



Enter: Confirm selection.



ESC: Exit out of Soft Keyboard.

Exiting the main menu

Press the Menu button on the front panel to exit the current menu screen.
Continue pressing the Menu button until you return to the live mode screen.

Chapter 5

Live mode

Description of live mode

Live mode is the normal operating mode of the unit where you watch live pictures from the cameras. The TVR 60 automatically enters into live mode once powered up. On the display screen, you can see the current date and time, camera name, and whether a recording is in progress.

Displaying status information

Information on the camera status is displayed on-screen as icons on the main and spot monitors. The camera status icons are shown for each camera. These icons include:

Table 8: Description of live mode camera status icons

Icon	Description
M	Yellow icon indicates detection.
R	Green icon indicates continuous recording.
A	Red icon indicates an alarm notification.
V	Blue icon indicates video loss icon

The system status is displayed on the front panel by the status LEDs (see Figure 9 on page 24).

Digital zoom

You can easily zoom in or out of a camera image in live mode and playback using the digital zoom function. The zoom function magnifies the camera image four times. See Figure 13 on page 34.

Figure 13: Digital zoom screen



To quickly zoom in/out on a camera image:

1. Select the camera you wish to use.
2. Left-click the mouse and select the option **Digital Zoom**, or on the front panel press the **Zoom+** button. The digital view screen appears.
3. Left-click the mouse and drag the red square to the area of interest, or move the joystick on the front panel to position the red square. The selected area is magnified.
4. To exit digital zoom right-click the mouse and select **Exit**, or press the **Zoom—** button on the front panel.

Switching monitors

The TVR 60 can be connected to up to three monitors. However, only one monitor can be controlled at a time. You can select from which monitor to display the camera views in live mode.

Table 9: Description of the monitor functions

3 monitors connected		2 analog monitors connected	
Output	Description	Output	Description
A	Monitor VGA. This is the main monitor. All features can be accessed.	A	Monitor A. This is the main monitor. All features can be accessed.
B	Monitor A. All features except the DVR configuration can be accessed from this monitor.	B	Monitor B. All features except the DVR configuration can be accessed from this monitor. Default spot monitor. Alarm pop-ups appear on this monitor.
C	Monitor B. Default spot monitor. Alarm pop-ups appear on this monitor.		

Note: All monitors can be configured to display alarm pop-ups. See “Configuring display options” on page 42.

To select a monitor:

- On the front panel, press:
 - **3 monitors connected:** the A button to select monitor VGA or the B button to select monitor A.
 - **2 analog monitors connected:** the A button to select monitor A or the B button to select monitor B.

Pop-up menus for mouse operation

Many features of the live mode can be quickly accessed by placing the cursor on a live image and clicking the right-button of the mouse (see Figure 14 below).

Figure 14: Live mode mouse pop-up menu for the main monitor

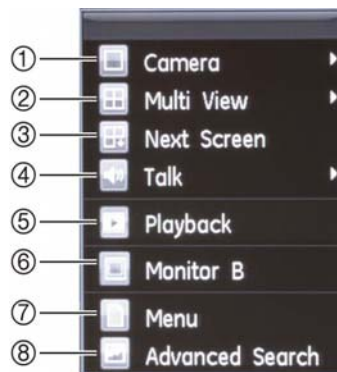

The list of features available depends on which monitor is active. See Table 10 on page 36.

Table 10: Pop-up mouse menus

Item	Name	Description
1.	Camera	Switch to a full-screen view for the selected camera.
2.	Multi View	Switch between the different multiscreen options.
3.	Next Screen	Displays the next camera.
4.	Talk	Modify the audio volume or disable audio.
5.	Playback	Enter playback mode.
6.	Monitor B	Switch between monitors A (main) and B.
7.	Menu	Enter the Main menu. Option is not available from monitor B.
8.	Advanced Search	Enter the advanced video search menu.

Viewing in full screen

Press the numeric button on the front panel to switch to the corresponding camera display. For example, press button 10 to view camera 10.

Right-click the mouse and select **Camera** from the menu shown. Select the camera required.

Viewing in multiscreen

A cameo is any cell in a multiscreen display. A camera picture can only be shown in one cameo at a time. The TVR 60 has five multiscreen display formats available as well as full screen. See Figure 15 below.

Configure which multiscreen display appears by default in the Display menu. See “Configuring display options” on page 42.

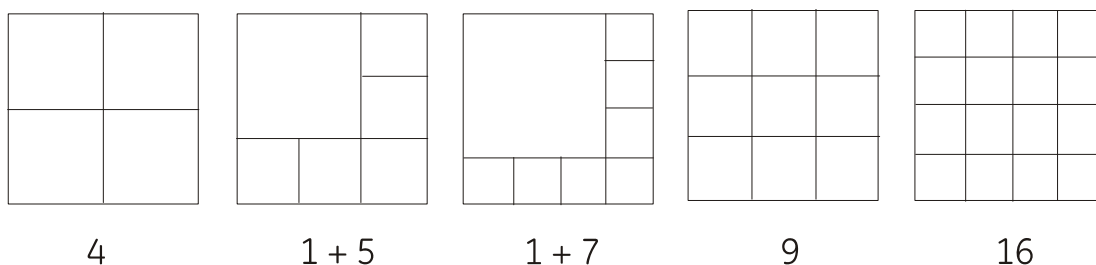
Figure 15: Display formats

To select a multiscreen format:

1. Press the Display button on the front panel to cycle through different display formats.

You can also right-click the mouse and select MultiView from the menu. Select the desired multiscreen display layout.

Sequencing cameras in live mode

The sequencing feature allows a camera to be displayed briefly on-screen, before advancing to the next camera in the sequence list. Sequencing can only be done in full screen mode.

Each camera on the main and spot monitors can have a pre-programmed dwell time and sequence order. See “Sequencing cameras” on page 44 for the setup information. The default sequence displays each camera in numerical order.

Sequencing live mode:

1. Select the camera where you want to start sequencing.
2. Press the **Seq** button on the front panel.
3. Press the **Seq** button again to stop the sequencing.

Cameo shortcuts

Regularly used features of live mode can be quickly accessed by clicking the left-button of the mouse. The Cameo shortcut pop-up menu appears (see Figure 16 below).

Figure 16: Cameo shortcut pop-up menu

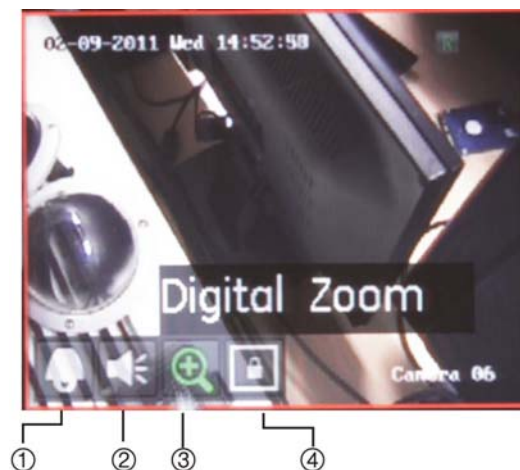

Table 11: Cameo shortcut pop-up menu

Item	Name	Description
1.	PTZ	Enter PTZ control mode.
2.	Audio	Enable/Disable audio output. The audio option must already have been setup in the Display menu.

Item	Name	Description
3.	Digital zoom	Enter digital zoom.
4.	Freeze	Freeze the live image of the selected camera of the current display mode. Although the image pauses, time and date information does not. The system clock continues to run.

Chapter 6

Configuring the live mode display

This chapter describes how to configure the on-screen image in live mode as well as set up the DVR name and address, enable password protection, and set up the system time and date.

You can change the settings in the screens in any order. They are described in the following sections.

Configuring monitor and DVR options

Use this screen to configure the monitor image as well as to configure the DVR name and address. See Figure 17 below.

The TVR 60 can support NTSC or PAL video output. The video format is auto detected.

The VGA monitor is the main monitor by default and the spot monitor is monitor C. When no VGA monitor is connected, the main monitor then becomes monitor B.

Figure 17: Monitor setup screen

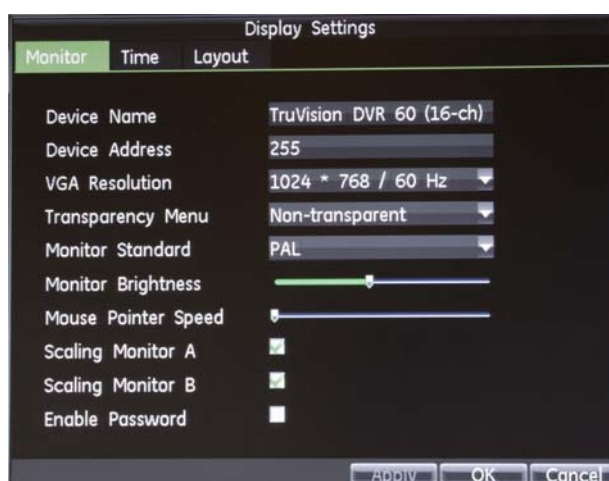

Table 12: Description of the Monitor setup screen

Option	Description
Device name	The name to use for the DVR.
Device address	The device number to use for the DVR when programming the remote control or keypad.
VGA resolution	Define the VGA resolution. Select one of the options from the drop-down list. Default is 1024×768/60 HZ.
Transparency menu	Modify the transparency of the menus on-screen relative to the background to make the menu screens easier to read or less prominent on-screen. Default is non-transparent. Select one of the options from the drop-down list.
Monitor standard	The video standard used is auto detected. Modify the video standard used to PAL or NTSC.
Monitor brightness	Modify the video output brightness.
Mouse pointer speed	Modify the speed of the mouse pointer.
Scaling monitor A / B	Enable/disable the monitor display of the main (A) and spot (B) monitors size to accommodate for differently sized monitors.
Password required	Enable/disable system password.

DVR name and address

The DVR name is the name that appears on-screen such as during start up.

When you use the IR remote control or keypad to operate the TVR 60, the TVR 60 must have a device address (bus ID). The default device address is 255 for a remote control.

If there is more than one DVR used, each device must have its own unique device address as otherwise the IR remote control will control all the DVRs together.

To configure the device name and address:

1. Enter the Display Settings screen by selecting **Display** in the main menu.
2. Click the **Monitor** tab. The Monitor screen appears.
3. In the Device Name box, enter a name for the TVR 60 unit. You can enter up to 38 characters.
4. Click the Device address edit box. The virtual keyboard appears. Enter a numeric value and click **Enter**. Up to eight digits can be entered. Default address for the remote control is 255
5. Click the **Apply** button to save the settings.
6. Click **OK** to return to the main menu.

Monitor setup

To configure monitors:

1. Enter the Display Settings screen by selecting **Display** in the main menu.
2. Click the **Monitor** tab. The Monitor screen appears. Modify the required settings. See Table 12 on page 40.
3. Click the **Apply** button to save the settings.
4. Click **OK** to return to the main menu.

Enabling a password

The Password Required option determines whether or not users must enter their passwords to gain access to the different functions of the DVR.

To enable password access:

1. Enter the Display Settings screen by selecting **Display** in the main menu.
2. Click the **Monitor** tab. The Monitor screen appears.
3. Check the Password Required box to enable or disable the option.
4. Click the **Apply** button to save the settings.
5. Click **OK** to return to the main menu.

Configuring time and date

You can set up the date and time that will appear on-screen and time stamped recordings. The start and end time of daylight savings time (DST) in the year can also be set. DST is deactivated by default. See Figure 18 below for the Time settings screen.

Figure 18: Time screen



Table 13: Description of the Time screen

Option	Description
Time zone	Select the time zone of the DVR from the drop-down list.
Date/time format	Select the date format from the drop-down list. Default format is DD-MM-YYYY.
Date/time	Select the date and time to be displayed on-screen and saved on recordings. Click the date icon on the right of the date list box. A calendar appears. Click the required date. In the time row select the correct time to be displayed.
Menu timeout	This is the length of time a menu is displayed on-screen. Only available for the main monitor. Default is five minutes. Select the required timeout period.
Enable DST	Click the check box to enable or disable daylight savings time (DST).
From / to	Set the duration of DST. Enter the start and end dates and time for daylight savings.
DST BIAS	Set the amount of time to move DST forward from the standard time. Default is 60 minutes.

To set up the system time and date:

1. Enter the Display Settings screen by selecting **Display** in the main menu.
2. Click the **Time** tab. The Time screen appears. Modify the required settings.
3. Click the **Apply** button to immediately implement the changes.
4. Click **OK** to save the changes and return to the main menu.

Changing the instant playback time

You can quickly replay the last few minutes of recorded video. Use this menu to set the exact replay period. The time options are between one to five minutes from actual time. Default is one minute.

To change the instant playback time:

1. Enter the Display Settings screen by selecting **Display** in the main menu.
2. Click the **Time** tab. The Time screen appears.
3. In the Instant Playback box select the desired replay period.
4. Click **OK** to return to the main menu.

Configuring display options

Use this screen to set up the different monitors as well as the multiscreen, and dwell time options. You can also enable audio output.

Figure 19: Layout screen**Table 14: Description of the layout screen**

Option	Description
Main monitor	Select which monitor will be the main monitor. Default is VGA, if connected.
Layout mode	Select which multiscreen layout will be default in live mode.
Main dwell time	Set the length of time for which a camera appears on-screen on the selected monitor before moving to the next camera during sequencing. Default is off.
Display layout	Set the camera order during sequencing. See “Sequencing cameras” on page 44 for more information.
Enable audio out	Enable/disable audio output.
Spot monitor	Select which monitor will be the spot monitor. Default is B monitor.
Spot dwell time	Set the length of time for which a camera appears on-screen on the spot (B) monitor before moving to the next camera during sequencing. Default is 10 seconds.

To set up the display options:

1. Enter the Display Settings screen by selecting **Display** in the main menu.
2. Click the **Layout** tab. The Layout screen appears. Modify the required settings.
3. Click the **Apply** button to save the settings.
4. Click **OK** to return to the main menu.

Audio set up

You can hear audio from cameras in both live and playback mode. However, in order to be able to hear audio in playback you must select the Enable Audio option in the Display menu.

To enable audio output:

1. Enter the Display Settings screen by selecting Display in the main menu.
2. Click the **Layout** tab. The Layout screen appears.

3. Enable/disable audio output
4. Click the **Apply** button to save the settings.
5. Click **OK** to return to the main menu.

Sequencing cameras

The cameras are sequenced in numeric order by default. You can change the sequence order of the cameras for all monitors. However, if three monitors are connected, monitor C sequencing cannot be started from the front panel.

You can switch the channel of a camera with that of another camera in the system. This lets you, for example, have the images of camera 1 appear on channel 10, and the images of camera 10 appear on channel 1. This feature is useful when you want to watch the images from specific cameras next to each other on-screen.

See Figure 20 below. Each cameo displays both the order of the camera in the sequence and the camera number.

Figure 20: Camera layout and sequence screen

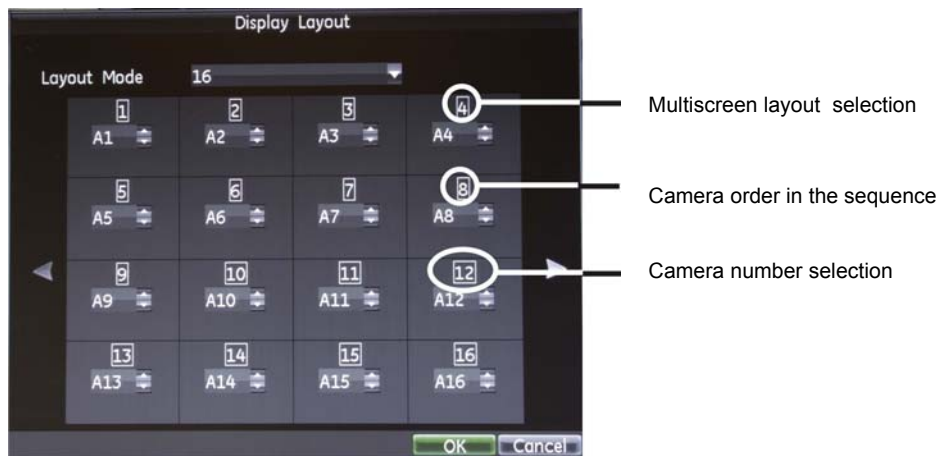

To set the camera sequencing:

1. Enter the Display Settings screen by selecting **Display** in the main menu.
2. Click the **Layout** tab. The Layout screen appears.
3. Select the desired monitor.
4. In the Display Layout option, click the **Setup** button. The Camera sequence screen appears.
5. In the Layout Mode list box select the required multiscreen layout display.
6. Click the cameo of the camera whose order you want to change. The selected cameo is highlighted green.
7. Click the scroll arrows alongside the camera number to move up or down the list of camera numbers. Select a camera.

Note: “X” means that the camera is not displayed.

8. Click the **OK** button to accept the changes and return to the Layout screen.
9. Click the **Apply** button to see the results immediately implemented. Click the **Setup** button again if further changes are required.
10. Click the **OK** button in the Layout screen to save changes and return to live mode.

Chapter 7

Controlling a PTZ dome camera

You can control PTZ dome cameras using the buttons on the front panel, the keypad, and IR remote control as well as using the PTZ menu accessed with the mouse. Access to PTZ functions may require a password.

Configuring PTZ settings

Use this screen to configure the PTZ dome cameras. Each camera must be set up individually. Cameras must be configured before they can be used.

Ensure that the RS-485 port on the rear panel, which is used to set up the PTZ dome cameras, and PTZ dome cameras are correctly connected.

Note: If a camera does not work correctly after configuring the DVR, check the parameters entered.

Figure 21: PTZ settings screen

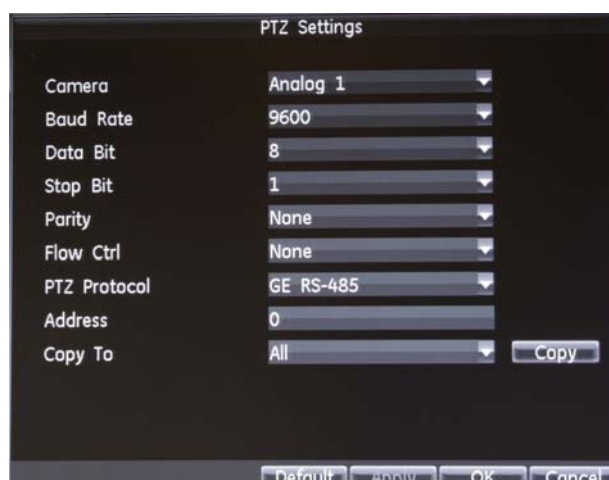

To configure PTZ dome camera settings:

1. Enter the PTZ Settings screen by selecting **PTZ** in the main menu.
2. In the Camera box, select the PTZ dome camera to be configured from the drop-down list.
3. Select the baud rate, data bit, stop bit, parity and flow control for the camera. The default values are:
 - Baud rate: 9600
 - Data bits: 8
 - Stop bits: 1
 - Parity: None
 - Flow control: None

Note: Click the **Default** button to return all values to default settings.

4. When all changes have been made, click the **OK** button to save the changes and return to the main menu.

Assigning PTZ protocols

Assign a PTZ protocol and address to a camera to allow PTZ control of the camera while in PTZ mode. See Appendix C “PTZ protocols” on page 135 for the complete list of available protocols. The default protocol is GE RS-485.

To configure PTZ settings:

1. Enter the PTZ Settings screen by selecting **PTZ** in the main menu.
2. In the Camera box, select the PTZ dome camera to be configured from the drop-down list.
3. Select a PTZ protocol in the PTZ protocol box.
4. Enter the PTZ address. Up to three digits can be entered. The number should correspond with that used in the PTZ dome camera itself.
5. When all changes have been made, click the **OK** button to save the changes and return to the main menu.

Copying settings to other cameras

PTZ dome camera settings can be copied to other PTZ dome cameras connected to the DVR. In the Copy To option of the PTZ menu, select a particular camera, or all cameras. Click **Copy**.

Pop-up menu for mouse operation

In PTZ mode use the mouse pop-up PTZ menu to get quick access to many PTZ functions. Right-click the mouse to call-up the pop-up menu. See Figure 22 below.

Figure 22: Mouse pop-up PTZ menu

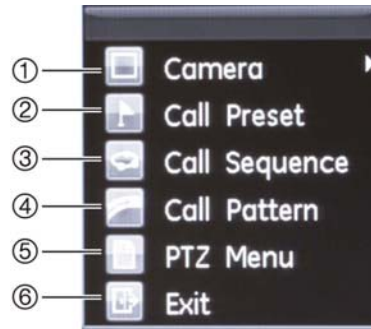

The items that can be found on this menu include:

Table 15: Description of the mouse pop-up PTZ menu

Item	Name	Description
1.	Camera	Select a PTZ dome camera.
2.	Call preset	Call up a preset position.
3.	Call preset tour	Call up a preset tour.
4.	Call shadow tour	Call up a shadow tour.
5.	PTZ menu	Open the PTZ menu.
6.	Exit	Exit PTZ mode.

Setting presets, preset tours and shadow tours

You can customize presets, preset tours and shadow tours for a connected PTZ dome camera.

Accessing PTZ mode

You can enter PTZ mode using the front panel, remote control, mouse and keypad.

Front panel	Press the joystick to Enter. PTZ control panel appears.
Mouse	Right-click the mouse on the desired camera image. The mouse pop-up control panel appears. Click the PTZ icon to enter PTZ mode. The PTZ control panel appears.
Remote control	Press the OK button. The PTZ control panel appears.
Keypad	Press the Enter ↵ button on the keypad. For further information, see “Operating the keypad” on page 142.

If the display was in multiscreen format, it changes to full screen format. See Figure 23 below for a description of the PTZ control panel.

Figure 23: PTZ control panel

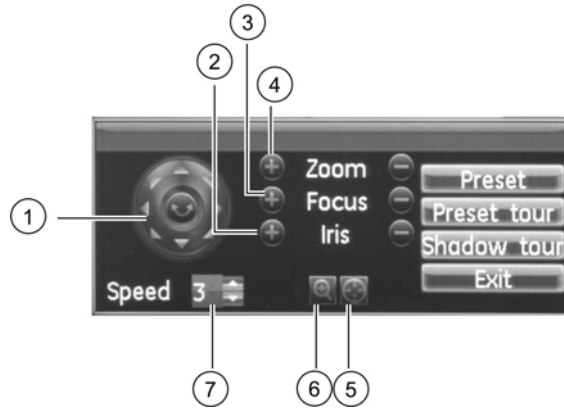

1. Directional pad/auto-scan buttons: Controls the movements and directions of the PTZ. Center button is used to start auto-pan by the PTZ dome camera.
2. Adjust iris.
3. Adjust focus.
4. Adjust zoom.
5. Centers the PTZ dome camera. This function is not supported on all PTZ dome cameras.
6. Instant zoom in. This function is not supported on all PTZ cameras.
7. Adjust speed of PTZ dome camera movement.

Setting a preset position

Use the Preset tab in the PTZ Control screen to select, set, and delete presets.

Figure 24: Preset selection and setup screen



To set up a preset:

1. Enter PTZ mode by left-clicking the mouse on the desired camera image and selecting the **PTZ** icon in the cameo shortcut menu.
- Or -
Press the front panel joystick for Enter.
The PTZ control panel appears.
2. Use the directional, zoom, focus and iris buttons to position the camera in the desired preset location.
3. Click the **Preset** button on the PTZ control panel. The PTZ Control screen appears with the Preset tab open.
4. Select a preset number and click the **Set** button. The preset is then enabled and stored in the camera.
5. Click the **OK** button to save changes and return to PTZ mode.

To delete a preset:

1. Enter PTZ mode by left-clicking the mouse on the desired camera image and selecting the PTZ icon in the cameo shortcut menu.
- Or -
Press the joystick for Enter on the front panel.
The PTZ control panel appears.
2. Click the **Preset** button on the PTZ control panel. The PTZ Control screen appears with the Preset tab open.
3. Select a preset number and click the **Clear** button.
Note: The Clear All button deletes all presets.
4. Click the **OK** button to save changes and return to PTZ mode.

Setting a preset tour

Preset tours move a PTZ dome camera to different steps and have it stay there for a set dwell time before moving on to the next point. The steps are defined by presets (see “Setting a preset position” on page 50.)

Each preset tour consists of steps. A step consists of a step number, a dwell time, and a speed.

The step number is the order the camera will follow while cycling through the preset tour. The dwell time is the length of time for which a camera stays at a step before moving to the next one. The speed is the rate at which the camera will move from one step to the next.

Note: The PTZ dome camera used must be able to support a preset tour function.

To set up a preset tour:

1. Enter PTZ mode by left-clicking the mouse on the desired camera image and selecting the **PTZ** icon in the cameo shortcut menu.
- Or -
Press the front panel joystick for Enter.
The PTZ control panel appears.
2. Click the **Preset Tour** button on the PTZ control panel. The PTZ Control screen appears with the Preset Tour tab open.
3. In the Preset Tour No. box select a preset tour to set.
4. In the list of presets, select the desired pre-programmed presets.
5. Click the **Set** button to enter the preset tour configuration menu. A preset tour should have at least two enabled presets.
6. Set the step number, dwell time, and speed.
7. Click the **OK** button to return to the preset tour configuration men.
8. Repeat steps 2 to 7 to configure other steps.
9. After all steps have been configured, click **OK** to save and return to PTZ mode.

To delete a preset tour:

1. Enter PTZ mode by left-clicking the mouse on the desired camera image and selecting the **PTZ** icon in the cameo shortcut menu.
- Or -
Press the front panel joystick for Enter.
The PTZ control panel appears.
2. Click the **Preset Tour** button on the PTZ control panel. The PTZ Control screen appears with the Preset Tour tab open.
3. Select a preset tour number and click the **Clear** button.
Note: The Clear All button deletes all presets.
4. Click the **OK** button to save changes and return to PTZ mode.

Setting a shadow tour

The Shadow Tour function remembers the PTZ dome camera movement track. Only one shadow tour can be set up.

Note: The PTZ dome camera must be able to support a shadow tour function.

To set up a shadow tour:

1. Enter PTZ mode by left-clicking the mouse on the desired camera image and selecting the **PTZ** icon in the cameo shortcut menu.

- Or -

Press the front panel joystick for Enter.

The PTZ control panel appears.

2. Click the **Shadow Tour** button on the PTZ control panel. The PTZ Control screen appears with the Shadow Tour tab open.
3. Select the shadow tour number from the list displayed.
Note: There is only one shadow tour.
4. To record a new shadow tour, click the **Run Shadow** button to start recording of the movements of the PTZ. Use the PTZ control panel to move the camera. The camera movements will be recorded until the **Stop Running** button is clicked.
5. Click the **OK** button to save and return to PTZ mode.

Calling up a preset position

Presets are previously defined locations of a PTZ dome camera. It allows you to quickly move the PTZ dome camera to a desired position. You must be in live mode to call up presets.

Note: Only enabled presets can be called up and deleted.

To call up a preset using the mouse:

1. Enter PTZ mode by left-clicking the mouse on the desired camera image and selecting the **PTZ** icon in the cameo shortcut menu. The PTZ control panel appears.
2. Click the **Preset** button on the PTZ control panel. The PTZ Control screen appears with the Preset tab open.
3. Select a preset number and click the **Call** button.
4. Click **OK**. The camera immediately moves to that preset position.

To call up a preset using the front panel:

1. Enter PTZ mode pressing the joystick for Enter on the front panel. The PTZ control panel appears.
2. Click the **Preset** button on the front panel.
3. Enter a preprogrammed preset number. The camera immediately moves to that preset position.

Calling up a preset tour

To call up a preset tour:

1. Enter PTZ mode by left-clicking the mouse on the desired camera image and selecting the **PTZ** icon in the cameo shortcut menu. The PTZ control panel appears.
2. Click the **Preset Tour** button. The PTZ Control screen appears with the Preset Tour tab open.
3. Select an enabled preset tour number and click the **Start** button.
To stop the preset tour, click the **Stop** button.

Calling up a shadow tour

To call up a shadow tour using the mouse:

1. Enter PTZ mode by left-clicking the mouse on the desired camera image and selecting the PTZ icon in the cameo shortcut menu. The PTZ control panel appears.
2. Click the **Shadow Tour** button. The PTZ Control screen appears with the Shadow Tour tab open.
3. Select the enabled shadow tour number and click the **Run Record** button.

To call up a shadow tour using the front panel:

1. Enter PTZ mode pressing the joystick for Enter on the front panel. The PTZ control panel appears.
2. Click the **Tour** button on the front panel. The shadow tour starts.

Chapter 8

Playing back a recording

The TVR 60 lets you to quickly locate and playback recorded video. There are a few ways to playback video:

- Instant playback of recorded video
- Search the video archives by specific time, date, or event,
- Search the system log

The DVR continues to record the live mode from a camera while simultaneously playing back video on that camera display. Access to playback functions may require a password.

You must be in live mode to playback video.

Figure 25: Playback screen

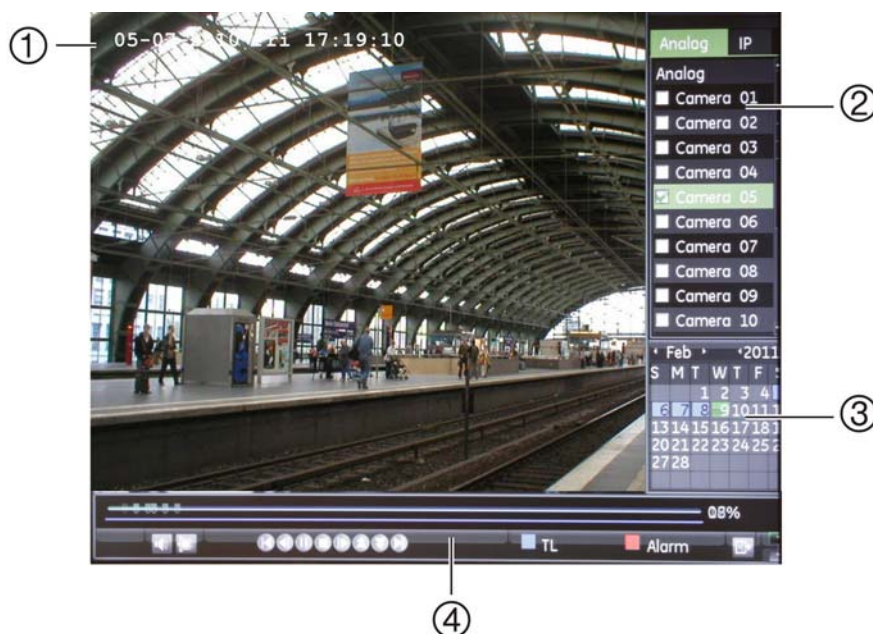

1. Running playback with date and time
2. Camera control panel. Used to select up to four cameras for playback
3. Calendar control panel.
Green: Current date
Blue: Recordings available on the unit
4. Playback control panel

The playback control panel

It is easy to select the start and end playback times using the playback control panel. See Figure 26 below.

Figure 26: Playback control panel

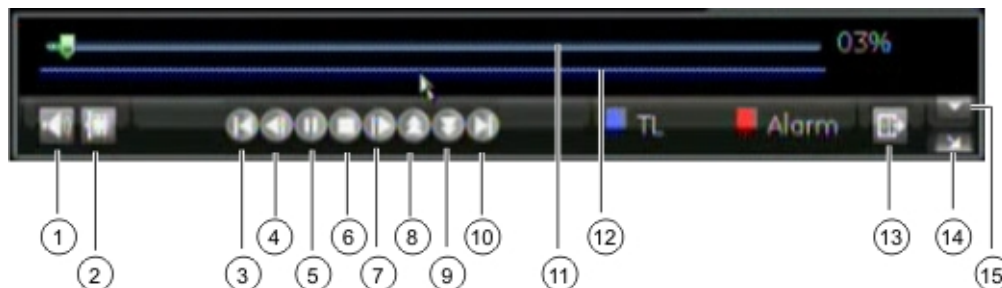

1. Audio on/off
2. Start/stop video clip during playback. Sections of a recording can be saved to an external storage device.
3. Previous file/day/event recording
4. Reverse playback by 30 seconds
5. Play/pause playback
6. Stop playback
7. Fast forward playback by 30 seconds
8. Increase playback speed. Options available are: single frame, 1/8 speed, 1/4 speed, 1/2 speed, normal, X2 speed, X4 speed, X8 speed, maximum speed.
9. Decrease playback speed: Options available are: single frame, 1/8 speed, 1/4 speed, 1/2 speed, normal, X2 speed, X4 speed, X8 speed, maximum speed.
10. Play next file/day recording in the search result
11. Timeline: The timeline moves left (oldest video) to right (newest video). Click a location on the timeline to move the cursor to where you want playback to start
12. Type of recording: Blue line indicates continuous recording. Red line indicates alarm/event recording
13. Quit playback and return to the Search screen
14. Hide the camera/date control panel
15. Hide the playback control panel

Playing back recorded video

You can easily search for recorded videos for playback. See Figure 28 on page 58.

You can playback up to four cameras at once. However, when using megapixel cameras you can only playback two megapixel cameras with a resolution greater than 4 CIF. If the resolution is less than or equal to 4 CIF, you can playback up to four megapixel cameras.

All multiscreen cameras in playback play simultaneously. This means, for example, that it is easy to follow the path of an intruder who has passed in front of several cameras.

Figure 27: Advanced Search screen**Table 16: Description of functions in the Advanced Search screen**

Function	Description
Analog / IP camera status	Displays all the analog and IP cameras set up in the system. A search can include both analog and IP cameras. At least one camera must be selected in a search. Use to select the cameras to include in the search.
Video type	Search for the type of event. The options available are: Time, Motion, Alarm, Motion or Alarm, Motion and Alarm, All.
Protected	Files found in a search can be protected against being subsequently deleted. Locked files cannot be deleted. There are three file protection options: Locked, unlocked, all. Unlocked is default. Use to select the protection status of a recording.
Start time	Use to select the start time and date for the search.
Details	Provides a detailed view of the type of events recorded on the selected camera or cameras over one day. The Detail screen can be used to narrow the time window in a day to be searched. Use the mouse to move the left green bar to change the search start time and the right blue bar to change the search end time. Click the Details button to enter the Detail sub-screen. If any changes are made to the position of the green or blue bars, click OK and return to the Advanced Search screen.
End time	Use to select the end time and date for the search.
Export	Use to archive selected files onto a storage device such as a USB.

Search results

A search will usually produce a list of files, which may extend to several pages. The files are listed by camera, and then for each camera by date and time. The oldest file is listed first. See Figure 28 on page 58 for an example of a search.

Only one file can be played back at a time.

Files can be locked by selecting a camera entry, which becomes highlighted, and clicking the Lock button. The icon in the Protected column then changes.

Figure 28: Example of a search result list

Camera	Start Time	End Time	Protected
A1	09-02-2011 08:00:00	08:29:20	<input type="checkbox"/>
A1	09-02-2011 08:29:20	09:37:53	<input type="checkbox"/>
A1	09-02-2011 09:37:53	10:46:29	<input type="checkbox"/>
A1	09-02-2011 10:46:29	11:55:02	<input type="checkbox"/>
A1	09-02-2011 11:55:02	13:03:38	<input type="checkbox"/>
A1	09-02-2011 13:03:38	14:05:06	<input type="checkbox"/>
A1	09-02-2011 14:06:57	14:13:58	<input type="checkbox"/>
A1	09-02-2011 14:13:58	14:43:54	<input type="checkbox"/>
A2	09-02-2011 00:00:03	00:34:21	<input type="checkbox"/>
A2	09-02-2011 00:34:21	02:19:58	<input type="checkbox"/>
A2	09-02-2011 02:19:58	04:05:52	<input type="checkbox"/>
A2	09-02-2011 04:05:52	05:52:10	<input type="checkbox"/>
A2	09-02-2011 05:52:10	07:37:27	<input type="checkbox"/>

Playing back files from a video search

To playback from one camera:

1. In live mode, select the camera display for playback.
2. Press the **Search** button on the remote control or front panel, or right-click the mouse and select the **Advanced Search** button. The Advanced Search screen appears.
3. In the Analog and/or IP Camera Status lines use the joystick to move the cursor to a camera check box and press **Enter** to select the desired camera. You can also use the mouse to click a camera's check box.
4. Using the joystick, move the cursor to each of the search parameters and select the options required. In the option box press **Enter** on the front panel to accept the change. You can also use the mouse to modify the parameters.
5. Click the **Search** button. The list of search results appears.
6. Using the joystick, move the cursor to the first line of the search results and press Enter to select. The line is highlighted green. To select a different search result line, move the cursor to the desired line and press Enter again.

You can also use the mouse to select a search result line.

Note: Only one line can be selected.

7. Press **Play**. The selected recording plays back immediately.
8. To stop playback, right-click the mouse and select the **Exit** button in the playback control panel.

To hide the playback control panel during playback, right-click the mouse and select the **Control Panel** button in the playback control panel.

9. When playback has finished, click **Exit** to the Search screen. Another search result can be selected.

To playback from more than one camera:

1. In live mode select the camera display for playback.
2. Press the **Search** button on the remote control or front panel, or right-click the mouse and select the **Advanced Search** button. The Advanced Search screen appears.
3. Use the front panel joystick to move the cursor to a camera check box and press **Enter** to select the desired cameras. You can also use the mouse to click a camera's check box.
4. Using the joystick, move the cursor to each of the search parameters and select the options required. In the option box press **Enter** on the front panel to accept the change. You can also use the mouse to modify the parameters.
5. Click the **Search** button. The list of search results appears.
6. Using the joystick, move the cursor to the first line of the search results and press **Enter** to select. The line is highlighted green. To select a different search result line, move the cursor to the desired line and press **Enter** again.

You can also use the mouse to select a search result line.

Note: Only one line can be selected.

7. Click the **Play** button. The Synchronous Playback Cameras screen appears which lists all the selected cameras. (The example below shows analog cameras only.)



8. Select up to four analog or two IP cameras to playback simultaneously and press the OK button.

The selected cameras play back immediately.

9. To stop playback, right-click the mouse and select the **Exit** button in the playback control panel.

To hide the playback control panel, right-click the mouse and select the **Control Panel** button in the playback control panel.

10. When playback has finished, click Exit. Another search result can be selected.

To do digital zoom in playback:

You can zoom in on an image during playback. During playback right-click the mouse to call-up the playback control panel. Click the **Zoom** button to enter digital zoom.

To hide the playback control panel:

To hide the playback control panel during playback right-click the mouse and select the **Control Panel** button.

To exit playback mode:

1. Press the **Live** button on the front panel to exit playback mode and return to live mode.

- Or -

Right-click the mouse and select **Exit** from the pop-up menu.

- Or -

Click the **Exit** icon in the bottom right corner of the playback control panel.

Instant replay of recorded video

Use the playback toolbar to quickly replay recorded video from the last few minutes. This can be useful to review an event that has just happened. The exact instant replay period of can be modified in the Display menu (see “Changing the instant playback time” on page 42.)

To instantly replay recorded video:

• Using the mouse:

1. In live mode right-click the mouse on the desired camera image. The mouse pop-up control panel appears. Click the **Playback** button to enter playback mode.
2. Playback from the selected camera starts in full-screen mode immediately from the pre-programmed time period for instant playback.

Note: A message appears if there are no recordings found during this period.

3. To include other cameras in the playback, click the camera type tab (Analog/IP) in the camera control panel and then select up to four cameras from the list.



Click the **Stop** button on the playback control panel and then click **Play** to restart playback. Playback restarts in multiscreen view.

- **Using the front panel/remote control:**

1. In live mode press the **Playback** button on the front panel or remote control to enter playback mode.
2. Press the **Analog** or **IP** button to select the camera type.
3. Press the camera number button for the desired camera.

Note: Multiscreen playback is only available using the mouse.

- 4 Playback from the selected camera starts immediately from the pre-programmed time period for instant playback.

Note: A message appears if there are no recordings found during this period.

Playing back from the system log

You can also playback recordings from the system log. The system log provides a much wider range of options for playback than Advanced Search, which deals with video detection and alarms only.

Figure 29: View log screen

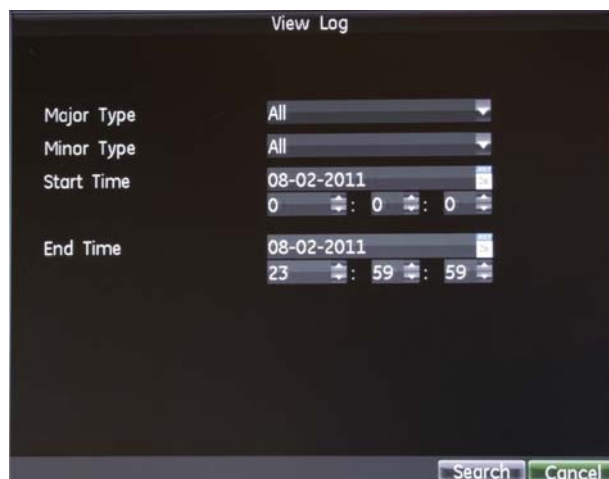

To playback video from the system log:

1. Press the **Menu** button on the remote control or front panel, or right-click the mouse and select the **Menu** button. The main menu screen appears.
2. Click the **System** icon. The System View screen appears.
3. In the View Log box, click the **View** button. The View Log screen appears.
4. In the Major Type box, select an option from the drop-down list.
5. In the Minor Type box, select an option from the drop-down list. The list of options available depends on the option selected under Major Type.
6. In the Start Time and End Time boxes, select the start and end times for the recordings to play back.
7. Click the **Search** button. A list of results appears.

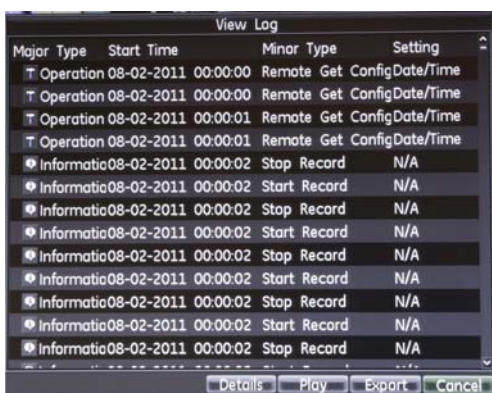

8. Select the video file to playback and click the:
 - **Details button:** For more information on the recording. It lists such information as start time, type of information, camera number, and gives a description on the types of events recorded and when record time was stopped.
 - **Play button:** Click to start playback of the recording.
 - **Export button:** Click to archive the file. The export screen appears.
 - **Cancel:** Click to return: to the previous screen.

Playing back frame-by-frame

You can easily playback a selected video at different speeds. This allows you to carefully examine an event, for example, frame-by-frame as it happens.

To playback frame-by-frame in playback mode:**• Using a mouse:**

1. In the playback screen click the **Speed Down** button on the playback control panel until the speed changes to Single frame.
2. Click the **Pause** button to advance the video frame by frame.

- **Using the front panel/remote:**

1. In the playback screen move the joystick to left to scroll down through the speed changes until Single frame.
2. Press **Enter** with the joystick to advance the video frame by frame.
3. Press the **Playback** button to do continue playback at normal speed.

Exiting playback mode

To exit playback mode, press **Menu** on the front panel or remote control, or right-click the mouse and select the **Menu** button.

Chapter 9

Archiving recorded files

Archive recorded files on an external device such as a USB flash drives, USB HDDs, eSATA device or a DVD writer. You must be in live mode to archive video. Access to archive functions may require a password.

Note: The USB port on the rear panel does not support USB CD/DVD burners or USB HDDs.

Archiving files

There are two ways to archive files:

Quick Archive: Quick archive lets you archive recorded files quickly by using the Archive button on the front panel. The TVR 60 then downloads all the recorded files on the unit to fill the available memory space on the media. This option is not available via the mouse.

Advanced Search screen: Use the Export function in the Advanced Search screen to specify archiving settings such as a specific time and date period as well as cameras.

Using Quick Archive

To archive recorded video using Quick Archive

1. Insert the backup device into the TVR 60.

If using a USB memory drive, insert the device into the USB port on the front panel. If using a digital video disk (DVD) or eSATA drive, insert the disc into the DVD drive. If more than one media type is found in the TVR 60, the USB device takes precedence over the others.

2. Press **Archive** to open the archive screen.
3. Press the **Archive** button on the front panel or remote control. The unit starts to download the files.

A message will appear to confirm when the download is complete.

Exporting recorded files to a backup device

You can insert a mini-USB hub to the USB port to attach a mouse for navigation and a USB drive for archiving. However, the unit may not support all types of USB hubs.

Figure 30: Export screen

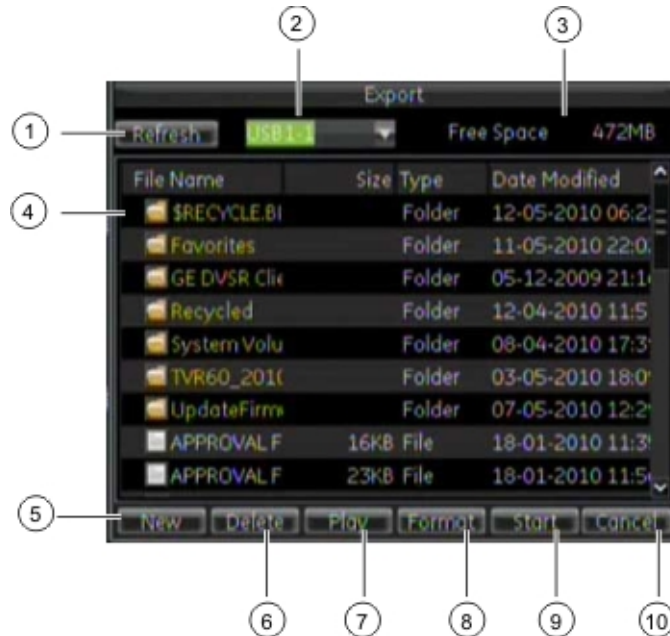

Table 17: Description of the Export screen

Item	Function	Description
1.	Refresh	Refresh the search results if any parameters have been modified.
2.	Media	Select one of the storage media for archiving: USB flash drive, USB HDD, or DVD writer). If the backup device is not recognized: <ul style="list-style-type: none"> • Click the Refresh button. • Reconnect device. • Check for compatibility from vendor.
3.	Free space	Free space available on the backup device is displayed.
4.	File	Files found on the backup device are listed.
5.	New	Create new folder.
6.	Delete	Delete selected file.
7.	Play	Play selected file.
8.	Format	Format the USB/eSATA drive.
9.	Start	Start downloading selected files onto storage medium.
10.	Cancel	Cancel search and return to previous menu.

To export recorded files to a backup device:

1. Connect the backup device to the DVR.

If using a USB memory drive, insert the device into the USB port on the front panel. If using a digital video disk (DVD) or eSATA drive, insert the disc into the DVD drive. If both media are found in the TVR 60, the USB device takes precedence over the DVD.

2. In live mode press the **Search** button on the remote control or front panel, or right-click the mouse and select the **Menu** button and the **Playback** button. The Advanced Search screen appears.

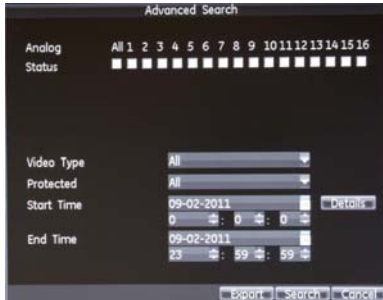

3. In the Analog Status line, select the cameras.
4. Select the search parameters

Function	Description
Video type	Search for the type of event or file. The options available are: Schedule, motion detection, alarm or motion detection and/ alarm, manual recording, all. Select an option from the drop-down list.
Protected	When a file is locked, the search results display "Locked" in the Major column. Locked files cannot be deleted. Select an option from the drop-down list.
Start time	Select the start time and date for the search.
Details	Provides a detailed view on camera recordings.
End time	Select the end time and date for the search.

5. Click the **Search** button. The list of results appears.
6. Click the video file or files to export.

Note: You can click the Play button to verify that the selected files are the files to export.

7. Press the **Export** button. The Export screen appears.

The size of the currently selected files is displayed in the upper-right corner of the screen.

8. Select the storage medium to export to from drop-down list.
9. Click the **Start** button to begin the backup process.

10. After the backup process has completed, you may select the files from your device and click the **Play** button to verify that it has been exported successfully.

Archiving video clips

You can save important scenes in a recorded file for later reference by creating video clips of selected portions of the file during playback. When an intruder, for example, crosses in front of several cameras you can save the video clip of the intruder's path across these cameras in a single file.

Note: This feature is only available using the mouse.

To export video clips during playback:

1. Connect the backup device to the TVR 60.
2. Search for the required files to playback. See "Playing back files from a video search" on page 58.
3. Select the file to playback and press the **Play** button. Playback starts immediately.
4. Click the playback timeline where you want the video clip to start and click the **Start Clip** button.
5. Click the playback timeline where you want the video clip to stop and click the **End Clip** button.
6. Repeat for additional clips.
7. Click the **Quit Playback** button to quit playback mode. A message appears asking if you want to save the video clips.
8. Click **Yes** to archive the clips. The Export screen appears.
Click **No** to exit and return to the search results screen.
9. In the Export screen select from the drop-down list the backup device to be used.
10. Click the **Start** button. File downloading starts.

Note: You can create a new folder for the video clips. Press the New Folder button and enter the folder name.

Managing backup devices

You can manage backup devices from the Export screen (see Figure 30 on page 66.)

The Export screen allows you to:

- **Create New Folder:** Creates a new folder on the backup device.
- **Delete:** Delete a file or folder from the backup device.
- **Play:** Play the selected video file from the backup device.
- **Format:** Format the backup device.
- **Erase:** Erase files from a re-writable CD/DVD.

Playing back archived files on a PC

Use the standard file player software to play back the archived video on your PC. It can be downloaded from the TVR 60 when archiving files onto a backup device.

Chapter 10

Using the Web browser

This chapter describes how you can use the Web browser interface to configure the device, play back recorded video, search through event logs, and control a PTZ dome camera. You can also specify settings on the Web browser interface to optimize video playback and recording performance when operating in a low or limited bandwidth environment.

Windows Vista and 7 users

Internet Explorer for Windows Vista and Windows 7 operating systems have increased security measures to protect your PC from any malicious software being installed. When using the TVR 60 Web browser interface, you can install ActiveX controls to connect and view video using Internet Explorer.

To have complete functionality of the Web browser interface and the DVR player with Windows Vista and Windows 7, do the following:

- Run the Browser interface and the DVR player application as an administrator in your workstation
- Add the DVR's IP address to your browser's list of trusted sites

To add the DVR's IP address to Internet Explorer's list of trusted sites:

1. Open Internet Explorer.
2. Click **Tools**, and then **Internet Options**.
3. Click the Security tab, and then select the Trusted Sites icon.
4. Click **Sites**.
5. Clear the "Require server verification (https:) for all sites in this zone" box.
6. Enter the IP address or DDNS name in the "Add this website to the zone" field.
7. Click **Add**, and then click **Close**.
8. Click **OK** in the Internet Options dialog screen.
9. Connect to the TVR 60 for full browser functionality.

Accessing the Web browser

To access the TVR 60, open a Web browser and enter the IP address assigned to the TVR 60, as a Web address. On the logon screen, enter the default user ID and password.

Note: Only one DVR can be viewed per browser.

User ID: admin

Password: 1234

The Web browser uses the following ports.

- IP address - 192.168.1.82
- Subnet mask - 255.255.255.0
- Gateway address - 192.168.1.1
- Video Port: 8000
- HTTP Port: 80

Web browser overview

The TVR 60 Web browser lets you view, record, and play back videos as well as manage all aspects of the DVR from any PC with Internet access. The browser's easy-to-use controls give you quick access to all TVR 60 functions. See Figure 31 on page 73.

Figure 31: Web browser interface



Table 18: Description of the Web browser screen

Item	Name	Description
1.	Menu toolbar	Lets you do the following: <ul style="list-style-type: none"> • View live video • Play back video • Search for event logs • Configure settings • Exit the interface
2.	Viewer	View live or playback video.
3.	PTZ controls	Control PTZ for the currently selected camera.
4.	Camera	View video and record video from the selected camera.
5.	Display layout	Define how you want video to be displayed in the Viewer.
6.	Video function	Lets you do the following: <ul style="list-style-type: none"> • Record live video • Take a snapshot of video • Enable recording for all cameras • Display previous camera view • Display next camera view
7.	Audio setting	Turn audio on or off.
8.	Video image settings	Adjust video image settings such as brightness, contrast, saturation, and hue. You can restore these settings to default.

Using the Web browser to configure the device

Click Config on the menu bar to display the configuration screen. There are two ways to configure the DVR: Local and Remote.

Local configuration

Local configuration lets you define communication and network parameters such as protocol type, maximum file size, stream type, network transmission settings. You can also specify the directory locations for saving recorded and playback video, captured images, and downloaded files.

Remote configuration

Remote configuration lets you remotely configure the following DVR settings:

Note: The configuration settings defined remotely are different from those that can be defined locally.

Figure 32: Remote browser configuration screen (Video parameters shown)

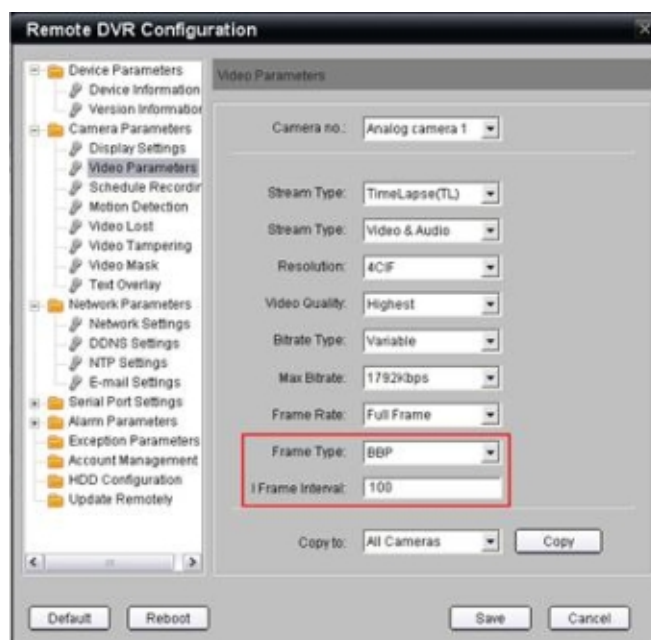

Caution: You can adjust the frame type and I-frame ratio of the camera streaming configuration (see the boxed area in Figure 32). However, these settings have a direct impact on the recorded video quality and streaming behavior. Changing the factory default settings can result in loss of streaming performance and poor video quality. It is strongly recommended that the factory default values are not changed.

- DVR information including device name, number, and display scale

- Camera settings including motion detection, privacy masking, video loss, video tampering, video image display settings, and text overlay
- Recording settings including recording schedule and recording quality
- Network settings including, e-mail, DDNS, and NTP setup
- Serial port settings including RS-485 and RS-232 parameters
- Alarm settings including alert notifications, audio alerts, pre-alarm, and post-alarm seconds, and notification parameters
- System settings including, user management, date and time, audio, RS-485, RS-232, language, alarm notification and hard drive setup

The remote configuration screen also lets you remotely upgrade the DVR firmware. See Figure 32 on page 74.

Searching and playing back recorded video

To search and play back recorded video, click Playback on the menu bar to display the Playback page shown in Figure 33 on page 76.

Figure 33: Browser playback page



- | | |
|--|---|
| <ul style="list-style-type: none"> 1. Calendar. Selected day is highlighted 2. Selected camera 3. Playback control toolbar 4. Timeline (TL). Indicates video recorded for the specified day as well as type of recording 5. Click to capture a snapshot of the video 6. Click to save the video playback | <ul style="list-style-type: none"> 7. Type of recording:
 Blue: Indicates video recorded based on the recording schedule defined.
 Red: Indicates video recorded triggered by an alarm event. 8. Click to download the recorded video 9. Click to start Search |
|--|---|

Select a camera and a day to search from on the calendar displayed, and then click Search. The timeline below the page indicates video recorded for the specified day. The timeline also classifies by color the type of recording with each type.

Click and drag the marker across the timeline on where you want video playback to begin, and then click Play on the playback control toolbar. You can capture a snapshot of a video image, save the video playback, or download the recorded video.

Searching for event logs

The DVR compiles a log of events, such as the start or end of video recording, DVR notifications, and alarms, through which you can easily search. Logs are categorized by the following types:

- **Alarm:** Includes motion detection, tamper detection, video tampering, and other alarm events
- **Notifications:** Includes system notifications such as video loss, HDD failures, and other system-related events
- **Operations:** Includes users access to the Web interfaces and other operational events
- **Information:** Includes general information on the DVR actions, such as the start and end of video recording, etc.

To search for logs, click Log on the menu bar, select a log type, specify a date and time range, and then click Search.

Live dual streaming

The TVR 60 allows you to view from up to 16 cameras over a network. Dual streaming allows high quality video to be viewed in one stream (Stream A) and lower quality video to be viewed in another stream (Stream B) that can be easily streamed through a narrow bandwidth.

Dual streaming is only available in live mode using the browser. You cannot record.

To access live dual streaming via the browser:

1. In the Web browser interface right-click the mouse on the video image.
A pop-up box appears asking about dual stream selection.
2. Select main or substream option.

Controlling a PTZ dome camera in the Web browser

The Web browser interface lets you control the PTZ functions of a dome camera. Click on a PTZ dome camera and use the PTZ controls on the interface to control the PTZ functions.

Figure 34: PTZ controls



1. Directional pad/auto-scan buttons: Controls the movements and directions of the PTZ. Center button is used to start auto-pan by the PTZ dome camera.
2. Select preset function.
3. Adjust zoom, focus, and iris.
4. Adjust speed of PTZ dome camera movement.
5. Start preset function.

Chapter 11

Configuring recording settings

This chapter provides instructions on how to define the recording settings of your DVR. This chapter covers how you can configure your initial recording settings, schedule recordings, protect your recorded files, and set up your HDD for redundancy.

Initializing recording settings

Before you can set up your DVR to begin recording, you must first configure general recording settings for the analog cameras.

Note: IP cameras cannot be configured from the DVR. IP cameras are configured from the IP camera itself. Refer to the user manual provided with your IP cameras for more information.

To configure recording settings:

1. Enter the Record Settings screen by selecting **Record** in the main menu.



2. In the Recording tab screen select the camera for which you want to configure settings.

3. Configure the following settings:

- **Record Mode:** Select the encoding parameters, either Timelapse (TL), Alarm, or Schedule.
- **Record:** Select the type of stream to record, either video or video and audio.
- **Resolution:** Select the resolution of the recording. Options include: 4CIF, 2CIF, CIF, and QCIF.
- **Encoding:** Select either Variable or Constant bit rate.
- **Video Quality:** Select the quality at which to record.
- **Frame Rate:** Select the recordings frame rate. Full (PAL is 25 FPS and NTSC is 30FPS), 20, 16, 12, 10, 8, 6 (default), 4, 2, 1, 1/2, 1/4, 1/8, 1/16.
- **Max Bit Rate:** Select or define the custom maximum bit rate for recordings. The maximum bit rate must be calculated from your camera, background, and image quality requirements.

4. Click **Setup** under Advanced Settings to display the advanced recording settings.

5. Set the following advanced record settings:

- **Pre-recording:** Select the time in seconds to pre-record before the actual recording begins.
- **Post-recording:** Select the time in seconds to post-record after the actual recording has ended.
- **ADM:** Select the expiration time in days for recorded video. Recordings after expiration time are deleted. If it is set to '0,' the option is disabled.
- **Redundancy:** Specify whether to enable or disable redundant recording on the particular camera.
- **Record Audio:** Specify whether to record audio of the camera or not.

6. Click **OK** to save your changes and return to the previous screen.

7. Click the Advanced tab to open the Advanced settings menu.

- **Overwrite:** Enable or disable the Overwrite setting. Enabling this setting causes recorded files to be overwritten once the HDD is full.

- **e-SATA:** Select Backup or Storage Expansion.
8. Click **Apply**, and then **OK** to save your changes.

Defining a recording schedule

Defining a recording schedule lets you specify when the DVR records video and under what circumstances. Each camera can be configured to have its own recording schedule.

A recording schedule can be set for analog and IP cameras.

The schedules are visually presented on a map for easy reference. See Figure 35 below for an example.

Figure 35: Description of Schedule screen



1. **Camera.** Select a camera.
2. **Schedule day.** There are seven days to select: Sunday (Sun), Monday (Mon), Tuesday (Tue), Wednesday (Wed), Thursday, (Thu), Friday (Fri), and Saturday (Sat).
3. **Schedule time.** Represents the 24-hour cycle during which a schedule is selected.
4. **Time line (TL).** There is a 24-hour time line for each day. Up to eight recording periods can be scheduled during the 24-hour period.
5. **Recording type.** There are five recording types to select, which are color-coded:
 - TL *Time lapse* (Blue): Record from a specific time. Each blue square represents an hour in the 24-hour period
 - Motion (Green): Record only motion
 - M&A *Motion & Alarm* (Pale blue): Record motion and alarms
 - Alarm (Red): Record only alarms
 - None (Grey): No recording during this period

To set up a recording schedule:

1. Enter the Record Settings screen by selecting **Record** in the main menu.
2. Select the Schedule tab to open the Schedule menu (see Figure 35 on page 81).
3. Select a camera for which to edit the schedule.
4. Click **Edit**. The following screen is displayed.



5. Check **Enable Schedule**.
6. Select the day of the week for which you want to set up the schedule or select **All Week** to set up the schedule for the entire week.

You can define a schedule for each day of the week.

7. Set the start and end time for recording.

Define a time period by entering a start (left column) and end (right column) time. You can schedule up to eight time periods. Click All Day to record all day.

Note: Time periods defined cannot overlap.

8. Select a recording type.

This setting instructs the DVR to begin recording when an alarm is triggered. The recording type can be based on time and triggered by motion detection and/or an alarm.

9. Select a recording parameter.

Recording parameters include Scheduled or TimeLapse. If set to Scheduled, the DVR records based on the schedule defined. If set to TimeLapse, the DVR records continuously.

10. Click **OK** to finish configuration.
11. Repeat steps 3 to 9 for other cameras or copy the schedule settings from one camera to another.

To copy the current schedule settings to another camera, select a camera from the Copy To dropdown list, and then click **Copy**.

12. Click **OK** to finish and save the schedule settings.

Protecting recorded files

There are two methods to prevent recorded files from being inadvertently overwritten or deleted off the HDD. We highly recommend that important recorded events be protected from deletion. Recorded files can either be *locked* or the HDD that the files reside on can be set to *read only*.

Locking and unlocking recorded files

Lock files to protect them against being overwritten or deleted.

To lock or unlock a recorded file:

1. Enter the Video Search screen by pressing the **Search** button on the front panel or remote control, and then enter Advanced Search.



2. Search for the desired recording by entering search parameters.

Search parameters include Camera #, Video Type, Protected status, and Start/End Date/Time.

3. Click **Search**.

A list of recordings, similar to the figure below, matching the search parameters is displayed.

Camera	Start Time	End Time	Protect
A1	09-02-2011 08:00:00	08:29:20	🔒
A1	09-02-2011 08:29:20	09:37:53	🔒
A1	09-02-2011 09:37:53	10:46:29	🔒
A1	09-02-2011 10:46:29	11:55:02	🔒
A1	09-02-2011 11:55:02	13:03:38	🔒
A1	09-02-2011 13:03:38	14:05:06	🔒
A1	09-02-2011 14:06:57	14:13:58	🔒
A1	09-02-2011 14:13:58	14:43:54	🔒
A2	09-02-2011 00:00:03	00:34:21	🔒
A2	09-02-2011 00:34:21	02:19:58	🔒
A2	09-02-2011 02:19:58	04:05:52	🔒
A2	09-02-2011 04:05:52	05:52:10	🔒
A2	09-02-2011 05:52:10	07:37:27	🔒

4. Select the file you want to lock/unlock.
5. Click **Lock** to lock file.

The Locked column indicates whether a file is locked or not. Closed lock icons indicate locked files while opened lock icons indicate unlocked files. The Lock button toggles between Lock and Unlock, depending on the file.

6. Click **Cancel** to exit out of the Video Search menu.

Setting the HDD to read-only

When you set an HDD to *read-only*, recorded video files cannot be written to the HDD. If multiple HDDs are used, the DVR automatically records to the next HDD not set to *read-only*

To set a HDD to read-only:

1. Enter the HDD Management screen by selecting **System**, and then **Hard Disk** from the main menu.
2. Click the General tab.
3. Select the HDD you want to set to read-only.
4. Click **Mode**. The Mode screen displays.

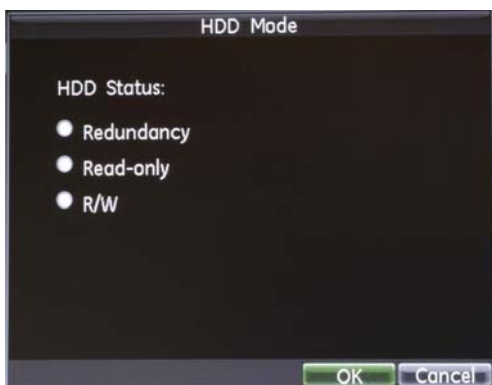

5. Select Read-Only.
6. Click **OK** to save your changes. The HDD is now read-only.

Note: In order to enable recordings on that particular HDD again, you must set the HDD status back to R/W (Read/ Write) in the HDD Mode screen.

Configuring advanced HDD settings

To prepare for any unexpected failures of hard disk drives, we recommend that you make a back up of your HDD. You must have more than one HDD in your DVR to set up HDD redundancy.

To set up HDD redundancy:

1. Enter the HDD Management screen by selecting **System**, and then **Hard Disk** from the main menu.
2. Click the General tab.

3. Select the HDD to be used for redundancy.



4. Click **Mode**. The Mode screen displays.
5. Select **Redundancy**.
Verify at least one other HDD is set to R/W (read/write).
6. Click **OK** to save the settings and return to the previous menu.
7. Enter the Record Settings screen by selecting **Record** in the main menu.
8. Click the Recording tab.
9. Select the camera to be used for redundancy.
10. Click the **Setup** button for Advanced Settings. The Record Settings screen appears.



11. Select **Yes** in the Redundancy box.
12. Click the **OK** button to save settings.
13. Repeat steps 8 to 12 for other cameras whose files you would like to be redundantly recorded.

Chapter 12

Configuring alarm settings

This chapter describes setting up how the system will respond when an alarm is triggered.

Motion detection

Motion detection is one of the most important features of a DVR. With it there is no need to manually search through hours of video recordings to find an event. The TVR 60 can be set up to trigger an alarm if it detects motion and to record it. You can then search these recorded motion activities for specific incidents. If enabled, motion detection recording can help increase the number of days your DVR can record.

You can mask out any areas of motion on an analog camera display that you do not want to trigger a recording such as a flag on a pole or a moving tree.

Select the level of sensitivity to motion as well the target size so that only objects that could be of interest can trigger a motion recording. For example, recording is triggered by the movement of a person but not that of a cat. Motion sensitivity and target size can only be set up using the mouse when in the motion detection area setup interface. See Figure 36 on page 88 for a description of the mouse pop-up menu.

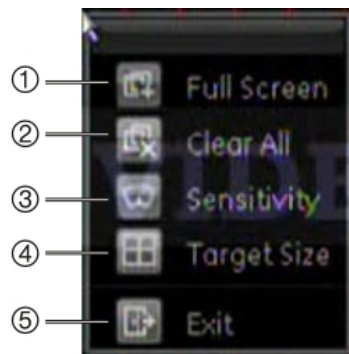
Figure 36: Mouse pop-up menu for motion detection mode

1. **Full screen:** Select the whole screen to be sensitive to motion detection.
2. **Clear All:** Clear all motion detection areas on-screen.
3. **Sensitivity:** Set the motion sensitivity level. There are five sensitivity levels: 0 (lowest) to 5 (highest).
4. **Target size:** Set the minimum number of zones in a camera image that must be activated simultaneously before it is considered to be valid motion. The value can be between 0 and 255 squares.
5. **Exit:** Return to the Advanced Camera Settings screen.

For analog cameras you can set up both the schedule and areas sensitive to motion detection for each camera individually or easily copy the settings of one camera to other cameras.

For IP cameras you can configure from the DVR the schedule when the camera can be triggered by motion. However, you need to configure the area of the video display sensitive to motion from the camera itself.

Note: For motion detection to work best the light in a camera area should be constant, and the background of the camera image should preferably be high-contrast.

Description of alarm notification types

When setting up the alarm rules for motion detection, you can specify how you want the DVR to notify you about an alarm. You can select more than one notification type.

Figure 37: Notification types



Note: To trigger the alarm indicator bar on the front panel to flash on and off when motion is detected, see “Setting up system notifications” on page 95.

The notification types that you can select include:

- **Full Screen:** When an alarm is triggered, the local spot monitor (VGA or BNC monitor) displays an image in live mode. This alarm can be configured under the Popup Alarm Image rules method. For alarms that are triggered simultaneously, images display one at a time every 10 seconds (default dwell time). You can set a different dwell time using the Dwell Time setting in the Display screen. When the alarm stops, cycling of the images stops and you return to live mode.
- **Buzzer:** Triggers an audible *beep* when a notification or alarm is detected.
- **TCP/IP:** Sends a signal to TruVision Navigator or other software applications when an alarm or notification is detected.
- **Alarm Out:** Trigger an alarm output when a notification is detected. An alarm output can be configured by following the steps listed in “Setting up external alarms” on page 92.
- **Email Notification:** Sends an e-mail when an alarm or notification is detected. Sending an email can be configured by following the steps listed in “Configuring e-mail settings” on page 103.

Setting up motion detection

Define the motion detection settings for each camera.

To set up motion detection:

1. Enter the Camera Management screen by selecting **Camera** in the main menu. The Camera Management screen appears.

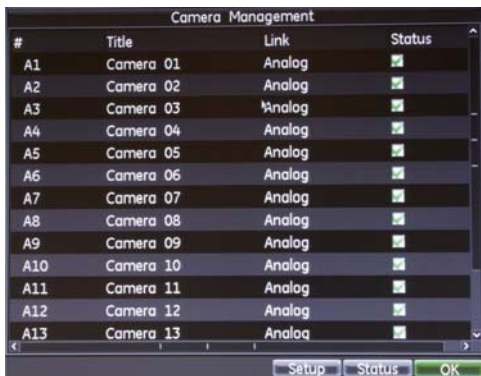

2. Select one or more cameras for which you want to configure motion detection, and then click **Setup** to display the Camera Settings screen.
3. Click the Advanced tab to display the Advanced Camera Settings screen.



4. Check the **Motion Detection** box to enable motion detection. The Area Setup button is activated.
5. Select the areas sensitive to motion.

Click **Area Setup** to enter the motion detection area setup interface.

Note: This option is only available for analog cameras. The button is inactive for IP cameras.

The motion detection area setup interface appears. It lets you define areas where you want motion to be detected. By default the whole screen is selected and appears as a red grid (295 squares). Click and drag an area to deselect that area for motion detection. Areas covered by the red grid are sensitive to motion detection.

Right-click the mouse and click **Sensitivity** from the pop-up menu to set the motion detection sensitivity. A higher value indicates higher sensitivity and vice versa. Click **OK** to accept and return to the motion detection area setup interface.

Again right-click the mouse and click **Target Size** to specify how many grid squares must be activated before motion is detected. Enter a value between

0 and 255 squares. Click **OK** to accept and return to the motion detection area setup interface..

Right-click the mouse and click **Exit** to return to the Camera Settings screen.

6. Select the cameras to be triggered for recording when motion is detected.

Click Motion Detection **Rules** to open the Rules screen.

Click the **Associated Cameras** tab.

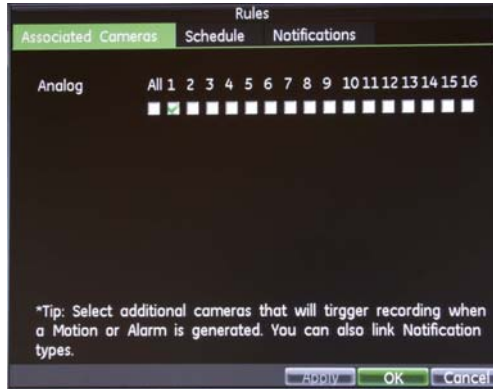

Check the boxes under the desired cameras. Both analog and IP cameras can be selected. Click **OK** to complete motion settings for the selected camera.

7. Select the recording schedules for motion detection.

Click the **Schedule** tab to define a recording schedule for motion detection.



Select the day of the week for which you want to set up the schedule or select All Week to set up the schedule for the entire week. You can define a schedule for each day of the week. Default is all week.

Set the start and end time for recording. Define a time period by entering a start (left column) and end (right column) time. You can schedule up to eight time periods. Default is 24 hours.

Note: Time periods defined cannot overlap.

8. Select the notification method.

Click the Notifications tab to define the method by which you want the DVR to notify you of a motion detection alarm for the selected cameras. The

notification options available are: Buzzer, TCP/IP notification, Alarm Out, and Email.

9. Click **Apply** and then **OK** to save your changes and return to the Advanced menu.
10. Copy these motion detection settings to other cameras, if required.
11. Click **Apply** and then Click **OK** to return to the Camera Management screen.

Setting up external alarms

The DVR can be configured to record when an alarm is triggered by an external alarm device (for example, PIR detector, dry contacts...).

To set up external alarms:

1. Enter the Alarm Management menu by selecting **Alarms** in the main menu.

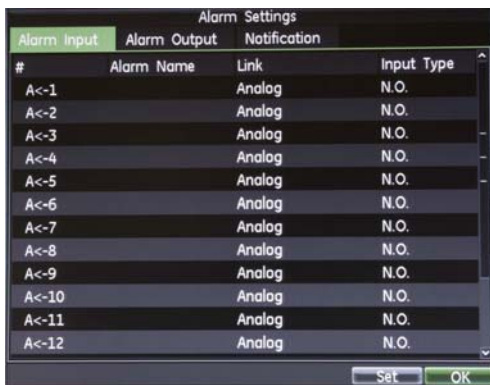

2. Under the Alarm Input tab, select the Alarm Input number of a camera and click **Set**. The Alarm Settings screen displays.

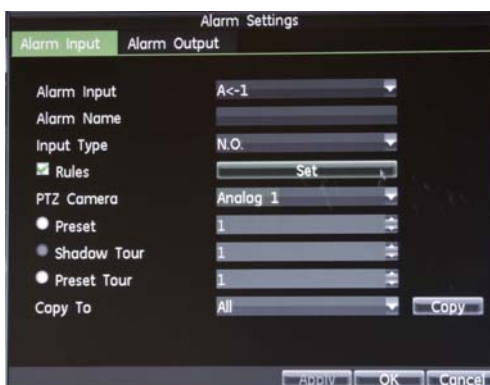

3. Select the alarm input type in the Input Type box.
Options available include: Normally Opened (NO) and Normally Closed (NC).
4. Set up the rules for the alarm inputs to be triggered, such as the alarm schedules and method of alarm notification.
Check the **Rules** box, and then click the **Set** button to enter the Rules screen.

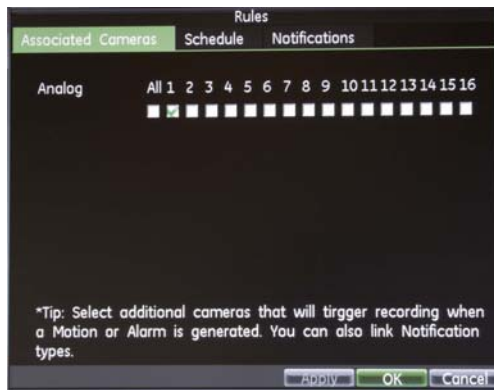

Click the **Associated Cameras** tab. Select the cameras to be triggered for recording when an alarm is detected by checking the boxes under the desired cameras. Both analog and IP cameras can be selected. Click the **Apply** button to complete setup.

Click the **Schedule** tab to define an alarm schedule for the output alarm.

Click the **Notifications** tab to define how you want the DVR to notify you of external sensor alarms. For more information, see “Description of alarm notification types” on page 88.

Click **Apply** and then **OK** to save your changes and return to the Alarm Settings menu.

5. Select the PTZ camera function required in response to an alarm.
6. Copy these settings to other inputs, if required.
7. Click **Apply** and then **OK** to return to the Alarm Management menu.

To set up an alarm output:

Note: Not all IP cameras can be triggered by an alarm output.

1. Enter into the Alarm Settings menu by selecting **Alarms** in the main menu. Select the camera to configure and click **Set**.
2. Click the **Alarm Output** tab in the Alarm Settings screen.



3. Select the output you want to configure and click **Setup**. Additional settings for the selected output appear.



4. Enter an alarm name for the selected output in the Alarm Name field.
5. Select an option in the Timeout box.

The timeout setting lets you define how much longer a signal remains active even after the alarm has ended. If you select Manually Stop, the signal remains active until it is manually acknowledged by pressing the alarm button on the front panel or remote control (see “Triggering alarm outputs manually” below).

6. Select a schedule for the alarm output. For example, if you only want the alarm signal to be active during the working hours.
7. Copy these settings to other outputs, if required.
8. Select **OK** to save and exit.

Triggering alarm outputs manually

When an alarm is activated, the DVR can be set up so that the alarm must be manually acknowledged in order to be silenced.

All user levels (administrator, manager and operator) can manually acknowledge an alarm.

To trigger alarm outputs manually:

1. Enter the Manual Alarm screen by selecting **System** in the main menu. In the System View screen, select **Alarm Out**. The Manual Alarm screen appears.

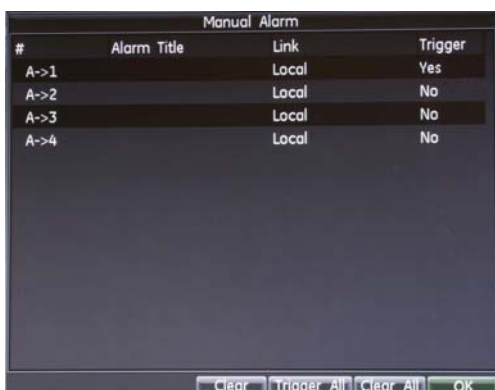

Select on of the following:

- **Clear:** Select an alarm from the list and click Clear to stop its output.
- **Trigger All:** Trigger all alarm outputs at once. For example, when you need to test them.
- **Clear All:** Stop all alarm outputs at once.

Click **OK** to return to the System View screen. The alarm is silenced.

- Or -

Press the **Alarm** button on the front panel. The alarm is silenced.

Setting up system notifications

Setting up system notifications instructs the DVR to alert you when irregular events occur and how to alert you to the event.

These system notifications include:

- **HDD Full:** All installed HDDs are full.
- **HDD Error:** Errors occurred while files were being written to the HDD, no HDD installed or HDD had failed to initialize.
- **Network Failed:** Disconnected network cable.
- **IP Address Conflict:** Conflict in IP address setting.
- **Log-In Fail:** Wrong user ID or password used.
- **Video Notification:** Unstable video signal or video loss detected.
- **PAL/NTSC Mismatch:** I/O video standards do not match.

Description of system alarm notification types

When setting up the alarm rules for system-wide events, you can specify how you want the DVR to notify you about an alarm. You can select more than one notification type.

The notification types that you can select include:

- **Full Screen:** When an alarm is triggered, the local spot monitor (VGA or BNC monitor) displays an image in live mode. This alarm can be configured under the Popup Alarm Image rules method. For alarms that are triggered simultaneously, images display one at a time every 10 seconds (default dwell time). You can set a different dwell time using the Dwell Time setting in the Display screen. When the alarm stops, cycling of the images stops and you return to live mode.
- **Buzzer:** Triggers an audible *beep* when a notification or alarm is detected.
- **TCP/IP:** Sends a signal to TruVision Navigator or other software applications when an alarm or notification is detected.

- **Alarm Out:** Trigger an alarm output when a notification is detected. An alarm output can be configured by following the steps listed in “Setting up external alarms” on page 92.
- **Email Notification:** Sends an e-mail when an alarm or notification is detected. Sending an email can be configured by following the steps listed in “Configuring e-mail settings” on page 103.
- **Other Notification: Panel Alarm LED:** Triggers the alarm indicator bar on the front panel to flash on and off when a notification or alarm is detected.
- **Motion Alarm:** Triggers the alarm indicator bar on the front panel to flash on and off when a motion alarm is detected. The Panel Alarm LED option must also be checked.

To set up system notifications:

1. Enter the Notification screen by clicking **Alarms** in the main menu, and then the Notification tab.

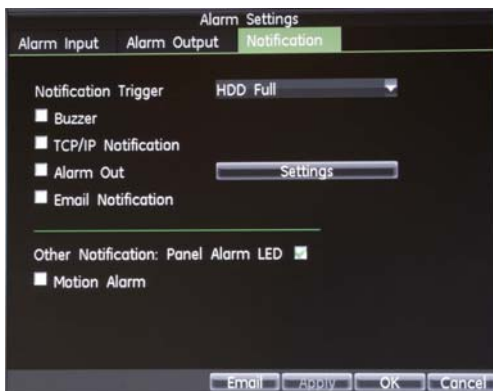

2. Select the notification event to configure under Notification Type box.
3. Select a notification type. See “Description of alarm notification types” on page 88 for more information.
4. Click **OK** to save and exit the Notification menu.

Detecting video loss

Video may be lost if the video cable or camera develop a fault or are damaged. You can set up your DVR to detect video loss and trigger a notification.

To setup video loss detection:

1. Enter Camera Management screen by selecting **Camera** in the main menu.

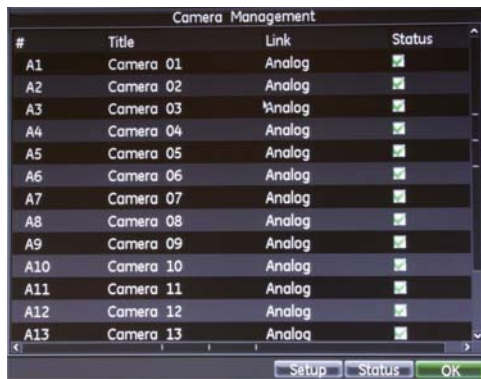

2. Select a camera to configure for video loss detection, and then click **Setup**.
3. Click the Advanced tab.
4. Check the **Video Loss Detection** box to enable feature.



5. Click **Rules** next to the Video Loss Detection box to enter the Rules screen.
6. Click the Notifications tab to define how you want your DVR to notify you of video loss. For more information, see “Description of alarm notification types” on page 88. Click **OK**.
7. Click the Schedule tab.
8. Set the schedule of when you want video loss detection to be enabled. Schedule can be set for all week or any day of the week with up to 8 time periods per day.
9. Click the **Apply** button to finish.
10. Repeat above for other channels.

Detecting video tampering

Video tampering, such as moving a camera to a different position, can also be detected and set to trigger an action on your DVR.

Both analog and IP cameras can be selected. However, not all IP cameras may support this feature.

Note: It is strongly recommended not to configure for video tampering when using PTZ dome cameras.

To set up video tampering detection:

1. Enter Camera Management screen by selecting **Camera** in the main menu.
2. Select a camera for which you want to configure video loss detection, and then click **Setup**.
3. Click the **Advanced** tab.
4. Check the **Tamper Detection** box to enable the feature.
5. Click **Area Setup** next to the Tamper Detection box to enter the tamper detection area setup interface.
6. Define a tampering area.

The tamper detection area setup interface, shown in the figure below, lets you to define areas where you in which you want camera tamper to be detected. Click and drag an area to mark that area for video tampering. Marked areas are outlined by a red outline. You can only set one tampering area with the full screen being the maximum area.

7. Right-click the mouse, and then click **Sensitivity** to set the tamper detection sensitivity. A higher value indicates higher sensitivity and vice versa.

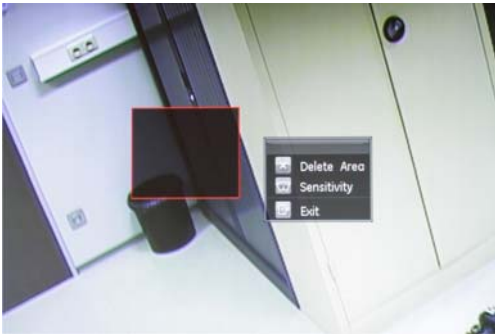

8. Click **Exit** to return to the Camera Settings screen.
9. Click **Rules** next to the Tamper Detection box to enter the Rules screen.
10. Click the **Notifications** tab to define the method you want your DVR to notify you of video tampering. See “Description of alarm notification types” on page 88 for more information. Click **OK**.
11. Click the **Schedule** tab. Set the schedule of when you want video tampering detection to be enabled. Schedule can be set for all week or any day of the week with up to eight time periods per day.
12. Click the **Apply** button to finish.
13. Repeat steps 2 to 12 for other cameras.

Chapter 13

Configuring network settings

You must configure your DVR's network settings before using your DVR over the network.

Note: As every network configuration may differ, please contact your Network Administrator or ISP to see if your DVR requires specific IP addresses or port numbers.

Configuring basic network settings

To configure basic network settings:

1. Enter the Network Settings screen by selecting **Network** in the main menu.

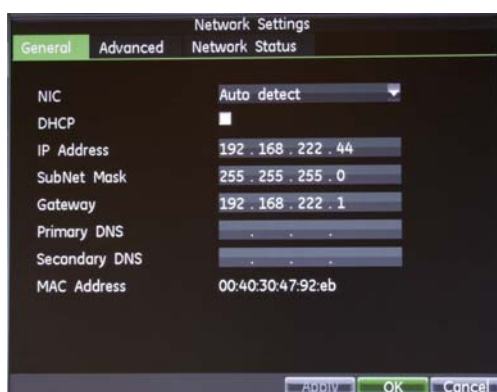

2. Click the **General** tab.
3. If you have a DHCP server running and want your DVR to automatically obtain an IP address and other network settings from that server, check the DHCP box. You can check the DHCP status by going to the Network Status tab.
4. To configure your own settings, enter the settings for:
 - **IP Address:** The IP address you want to use for your DVR.

- **Subnet Mask:** The subnet mask for your network so the DVR will be recognized within the network.
 - **Gateway:** The IP address of your network gateway so the DVR will be recognized within the network. This is typically the IP address of your router.
 - **Primary/Secondary DNS Server:** The preferred and alternate Domain Name System (DNS) Server to use with your DVR.
5. Click **OK** to save and exit the Network Settings menu.

Configuring the DDNS

If your DVR is set up to use PPPoE as its default network connection, you can set up Dynamic DNS (DDNS) to be used in conjunction.

To set up DDNS:

1. Enter the Network Settings screen by selecting **Network** in the main menu.
2. Click the Advanced tab.
3. Click **Setup** next to DDNS to enter the DDNS screen.



4. Check the **DDNS** box to enable feature.
5. Select a DDNS Type.

You can select one of the following:

- **PeanutHull:** Enter the User Name and Password obtained from the PeanutHull website.
 - **DynDNS:** Enter the Server Address for DynDNS (i.e. members.dyndns.org). In the DVR Domain Name field, enter the domain obtained from the DynDNS Web site. Then enter the User Name and Password registered in the DynDNS network.
6. Enter the Server Address and the DVR Domain Name.
 7. Enter the User Name and Password.
 8. Enter the password again to confirm.

9. Click **OK** to save.

Configuring an NTP server

A Network Time Protocol (NTP) Server can also be set up on your DVR to keep the date and time current and accurate.

To set up an NTP server:

1. Enter the Network Settings screen by selecting **Network** in the main menu.
2. Click the Advanced tab.
3. Click **Setup** (next to NTP) to enter the NTP screen.

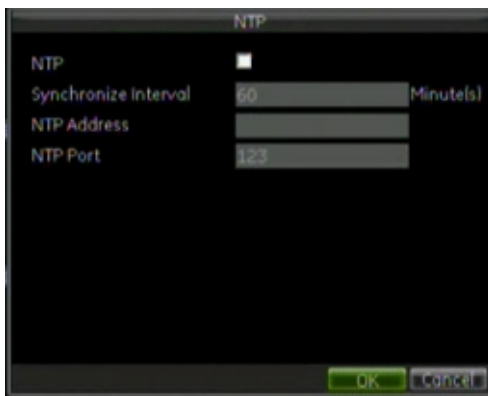

4. Check the NTP box to enable feature.
5. Define NTP settings by selecting one of the following options:
 - **Synchronize Interval:** Time in minutes to synchronize with NTP server.
 - **NTP Address:** IP address of NTP server.
 - **NTP Port:** Port of the NTP server.
6. Click **OK** to save and exit menu.

Configuring a remote alarm host

If a remote alarm host set, the DVR sends a signal to the host when an alarm is triggered. The remote alarm host must have the TruVision Navigator server software installed.

To set up a remote alarm host:

1. Enter the Network Settings screen by selecting **Network** in the main menu.
2. Click the Advanced tab.
3. Enter Alarm Host IP and Alarm Host Port.

Alarm Host IP represents the IP of the remote PC where the Network Video Surveillance software installed. The Alarm Host Port value must be the same as software's alarm monitor port. Default port is 7200.

Configuring multicast

Setting up multicasting resolves limitation issues when streaming videos through a network access device. A multicast address spans the Class-D IP range of 224.0.0.0 to 239.255.255.255. We recommend that the IP address range of 239.252.0.0 to 239.255.255.255 be used.

To set up multicasting:

1. Enter the Network Settings screen by selecting **Network** in the main menu.
2. Click the Advanced tab.
3. Enter a Multicast IP address.

Note: When adding a device to the Network Video Surveillance software, the multicast address must be the same as the DVR's multicast IP.



4. Click **OK** to save and exit menu.

Configuring the server and HTTP Ports

You can change the server and HTTP ports from the default settings in the Network Settings screen. The default server port is 8000 while the default HTTP port is 80.

To change the default ports:

1. Enter the Network Settings screen by selecting **Network** in the main menu.
2. Click the Advanced tab.
3. Enter the new Com Port and HTTP Port values.



Note: The Server Port has a port range of 2000-65535 and is used for remote client software access. The HTTP port is used for remote internet browser access

Configuring e-mail settings

Your DVR can send e-mail notifications of alarms or notifications through the network.

Note: Ensure that the DNS address has been set up correctly beforehand.

To configure e-mail settings:

1. Enter the Network Settings screen by selecting **Network** in the main menu.
2. Click the Advanced tab.
3. Click **Setup** next to Email to enter the Email screen.

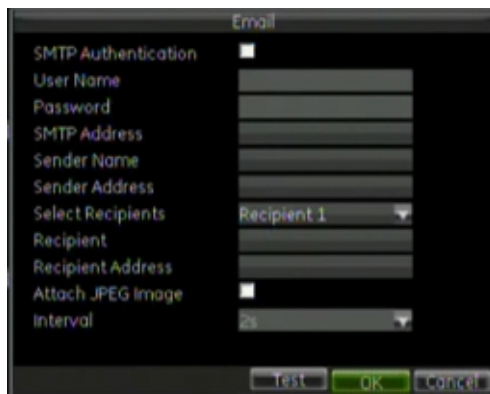

4. Enter a User Name and Password.
5. Enter the SMTP Server from whom the notification is sent.
6. Enter values for the From Name and From Email Address fields.

These values display the sender's name and e-mail address in the outgoing e-mail.

7. Select an e-mail recipient in the Select Recipients box.
8. Enter values for the To Name and From Email Address fields.

These values represent the recipient's name and e-mail address.

9. Check the Attach JPEG File box if you want to send an e-mail with alarm images.

10. Select an interval range in the Interval box.

The interval range represents the time range in between the alarm images sent. For example, if you set the interval range at two seconds, the second alarm image will be two seconds from the first alarm image.

11. Click **Test** to test e-mail settings.

12. Click **OK** to save and exit the E-mail screen.

Note: We recommend that you test the e-mail settings after entering values in the Email screen.

Chapter 14

Camera management

The TVR 60 can support up to 16 analog and eight 4-CIF IP cameras. However, the number of IP cameras supported can depend on the resolution of the IP cameras and on the number of analog cameras enabled. For a complete list of the analog and IP camera numbers that can be supported, see Appendix F “Camera matrix” on page 149. An example is shown in Table 19 below.

Table 19: Example of the number of analog and IP cameras supported for a TruVision 2 Mpx UP camera supporting UXGA (1600 x 1200 pixel resolution) at 12.5 fps max

Analog	Number of cameras			System performance
	IP SD - 4CIF	IP HD - 720p	IP HD - 2 Mpx	
16	8	-	-	24
16	4	2	-	22
16	4	-	2	22
16	-	4	-	20
16	-	2	2	20
16	-	-	4	20
8	12	-	-	20
8	6	3	-	17
8	6	1	2	17
8	-	6	-	14
8	-	2	4	14
8	-	-	6	14

IP cameras, unlike analog, can be configured over the network. Before configuring IP cameras, please ensure that all IP cameras are connected to the same network as your DVR and that the network settings for your DVR are properly setup. See Chapter 13 “Configuring network settings” on page 99.

Cameras are configured from the Camera management menu. See Figure 38 on page 106.

Figure 38: Camera management screen

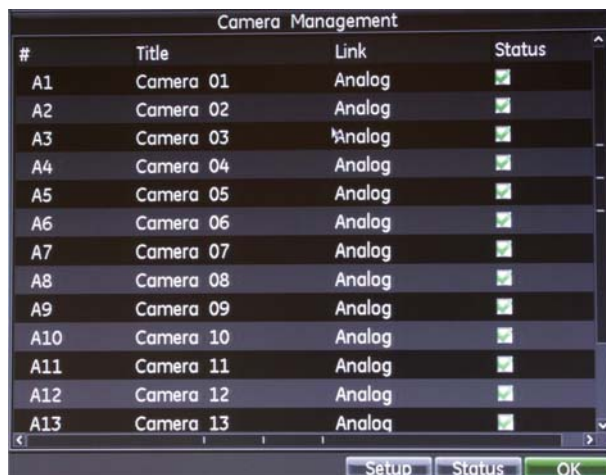

Enabling or disabling analog cameras

When you turn on the DVR the status of all 16 IP cameras is automatically on and all the cameras are recording, even if there are not 16 analog cameras connected. You can disable the unused camera links in order to save space on the hard drive.

You may also need to disable analog cameras in order to be able to add more IP cameras to the system. You need to disable one analog camera to add one 4CIF IP camera, and to disable two analog cameras to add one 720p IP camera.

To enable or disable analog cameras:

1. Enter the Camera Management screen by clicking **Camera** in the main menu.
2. Determine the number of analog cameras to disable.
3. Click the **Status** button to enter the Analog Camera Status menu.

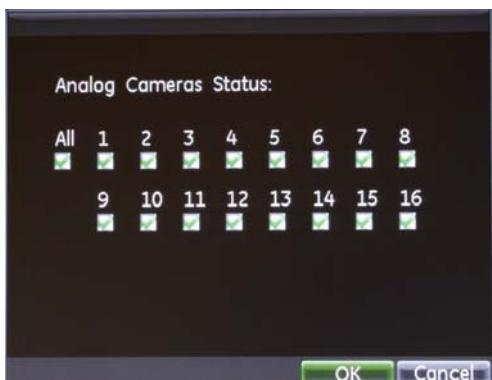

4. Clear the check boxes of the cameras you want to disable.
5. Click **OK** to save your settings.

A confirmation message appears on the screen prompting you to reboot the DVR. Click **Yes** to reboot.

Configuring IP cameras

Use the Camera Management menu to set up IP cameras. You can also add or delete IP cameras.

Only TruVision IP cameras can be configured from the DVR. The DVR detects and lists all TruVision IP cameras in the IP Camera Settings screen. By default they all have the same IP address. However, each camera must have a unique IP address in order to function correctly.

Note: UltraView IP cameras can only be configured using TruVision Navigator.

It is recommended to install all the analog cameras first and then the IP cameras so that the camera locations are all grouped together.

Add IP cameras individually to the system.

To configure IP cameras:

1. Enter the Camera Management screen by clicking **Camera** in the main menu.
The list of IP cameras available on the network is displayed.
2. Click **Setup**. The IP Camera Settings screen appears.



All TruVision IP cameras connected to the DVR over the same network are listed (there are no IP cameras installed in the example shown.)

3. Connect an IP camera to the network. It may take a minute or more to boot if you are using a PoE switch to power the camera.
4. Click **Refresh**.
The IP camera is now listed with its parameters including its IP address.
5. To change a camera's default IP address, select the camera by double-clicking the IP camera listed. In the screen that appears, enter the camera's IP address and password. The default password is 1234. Click **OK** to return to the Camera Settings screen. The new IP address for the selected camera is shown.
6. Select a camera from the list and enter its parameters.

Use the IP protocol TruVision H.264 (default is UltraView ENC 10.)

Enter the password of the IP camera under Admin Password. The default IP camera password is 1234.

Note: You must enter the password of the IP camera for the camera to be correctly installed.

- Click **OK** to save and return to the Camera Management screen. It takes between 10 and 20 seconds for the new IP camera to be listed.

When an IP camera has been successfully added, the status for that camera is displayed as enabled. If it has not been correctly installed (such as you didn't enter its password), delete the camera listed and repeat the procedure.

Configuring the OSD settings

You can configure what information is displayed on-screen for analog cameras only.

The on-screen display (OSD) settings apply on each display while in live mode and include the camera name, time and date.

To configure the OSD settings:

- Enter the Camera Management screen by clicking **Camera** in the main menu.
- Select camera for which to setup OSD settings in the Camera box.
- Click **Setup** to display the Camera Settings screen. The OSD tab is displayed by default.



- Enter a name for the camera.

Note: Although you can enter a camera title for an IP camera, it will not be displayed on-screen. The other OSD menu options are not available for IP cameras.

- Check the Display Camera Name, Display Date, and Display Week boxes if you want to display the camera name, date, and week.
- Select a Date Format and a Time Format.
- Select how you want the camera information displayed.

You can select one of the following options:

- Steady
- Steady & Flashing
- Transparent
- Transparent & Flashing

8. To configure where you want the camera information displayed on-screen, click **Text Position Setup**.

You are taken to a camera view screen and an area marked where the camera information is displayed. Click and drag the marked area anywhere on the screen to set the display position.

9. To copy the configured settings to a different camera (or all), select a Camera from the Copy To box, and then click **Copy**.
10. Click **Apply** to save your changes, and **OK** to exit the screen.

Setting up privacy masking

For analog cameras you can define an area on screen that can remain hidden from view. For example, you can choose to block the view of an analog camera when overlooking residential premises. This hidden area is referred to as privacy masking. Privacy masking cannot be viewed live or recorded, and appears as a blank screen on display.

However, although you can select the privacy masking option for IP cameras, you cannot set up an area where it applies on-screen. Areas are selected from the IP camera itself. Refer to the IP camera user manual for information on doing this.

To setup a privacy mask:

1. Enter the Camera Management screen by clicking **Camera** in the main menu.
2. Select camera for which to setup privacy masking in the Camera box.
3. Click the Advanced tab to enter the Advanced Camera Settings screen.



4. Check the Privacy Masking box to enable feature.

5. Click the **Area Settings** button to enter the privacy mask area setup interface.

The privacy mask area setup interface lets you define areas you want to mask for privacy.

Note: This option is only available for analog cameras.

6. Setup the mask area. Up to four areas can be set.

Click and drag on an area on the screen to mark that area as masked. You can set up to four areas for privacy masking. Masked areas are dimmed and outlined in red.



7. Click **OK** to save and exit.

Adjusting video image settings

You may need to adjust the camera image depending on the camera model or location background in order to get the best image quality. You can adjust the brightness, saturation, contrast, and hue of the video image.

Only the image quality of analog cameras can be modified.

To adjust display settings:

1. Enter the Camera Management screen by clicking **Camera** in the main menu.
2. Select the camera for which to adjust video image settings in the Camera box.
3. Click the Advanced tab to enter the Advanced Camera Settings screen.
4. Click **Setup** next to the Color Settings label.
5. Adjust the display settings.

Brightness, contrast, saturation and hue can be adjusted. Adjustments to the display settings affect both live mode and recorded images.



6. Click **OK** to save and exit,
- Or -
Click **Default** to return to default settings.

Chapter 15

HDD management

Initializing HDDs

The TVR 60 is shipped with the in-built HDD already initialized. You can re-initialize the HDD. However, all data on the HDD will be destroyed.

To initialize a HDD:

1. Enter the HDD Management screen by clicking **System** in the main menu, and then **Hard Disk**.



2. Select the HDD to be initialized.
3. Click the **Init** button.
4. Click **OK** to begin initialization.

After the HDD has been initialized, the status of the HDD changes from Abnormal to Normal.

Setting HDD groups

Your DVR can organize multiple HDDs into groups. Videos from specified channels can be set to be recorded onto a particular HDD group.

To set up a HDD group:

1. Enter the HDD Management screen by clicking **System** in the main menu, and then **Hard Disk**.
2. Select the HDDs to be added to the group.
3. Click **Group** to enter Group Settings screen.
4. Select the HDD Group Number 2.

Note: By default, all HDDs belong to group 1.



5. Click **OK** to save and exit the screen.

Setting the HDD status

You can change the behavior of your HDD by changing its status. The status of a HDD can be set to redundancy, read-only or read/write (R/W).

Setting the HDD to read-only

A HDD can be set to read-only to avoid important recorded files from being overwritten when the HDD becomes full.

To set a HDD to read-only:

1. Enter the HDD Management screen by clicking **System** in the main menu, and then **Hard Disk**.
2. Click the General tab.
3. Select the HDD to want to set to read-only.
4. Click **Mode**. The Mode screen displays.

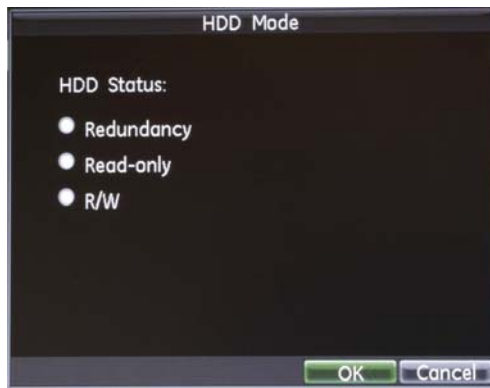

5. Select Read-Only.
6. Click **OK** to save and exit the screen.

Note: Once set to read-only, the HDD cannot be used to save recorded files until it is set back to read/write (R/W). If the HDD that is currently being written to is set to read-only, the data is then recorded to the next HDD. If there is only one HDD present, setting it to read-only causes the DVR to not record.

Setting the HDD to redundancy

To be able to use HDD redundancy on your DVR you need to have at least two HDDs installed. Setting up HDD redundancy lets your DVR redundantly record a copy of the videos onto multiple drives as a safeguard against losing all your files in case of disk failures. This process is also known as *mirroring*.

Redundancy significantly reduces the storage capability of the HDDs. As a result you need to double your capacity to record video over a given time.

To set up HDD redundancy:

1. Enter the HDD Management screen by clicking **System** in the main menu, and then **Hard Disk**.
2. Select the HDD you to set up for redundancy.
3. Click **Mode** to display the Mode screen.
4. Set the HDD Status to Redundancy.
5. Click **OK** to save and exit the screen.

Note: The HDD set to redundancy stores an extra copy of the recording. If an HDD is set to redundancy, at least one other HDD should be set to the R/W status.

Checking HDD status

You can check the status of any of the installed HDDs on the DVR at anytime.

To check the status of a HDD:

1. Enter the HDD Management screen by clicking **System** in the main menu, and then **Hard Disk**.
2. Note the status of the HDD listed under the Status column.

If the status is listed as Normal or Sleeping, the HDD is in working order. If it is listed as Abnormal and has already been initialized, the HDD needs to be replaced. If the HDD is Uninitialized, you need to initialize it before it can be used in the DVR. Refer to “Initializing HDDs” on page 113 for more information.

Alternatively, you can also view the SMART information of your installed HDDs. SMART, short for Self-Monitoring, Analysis and Reporting Technology is a monitoring system for hard disk drives to detect and report on various indicators of reliability in the hopes of anticipating failures.

To view SMART information of a HDD:

1. Enter the Log Search menu by clicking **System** in the main menu, and then **View Log**.



2. Set Major Type to Information.
3. Set Minor Type to HDD SMART.
4. Enter the Start Time and End Time.
5. Click **Search** to begin log search. A result list is displayed.



6. Select a log item to view and click the **Details** button.

A detail listing of SMART information is displayed, as shown in the below.

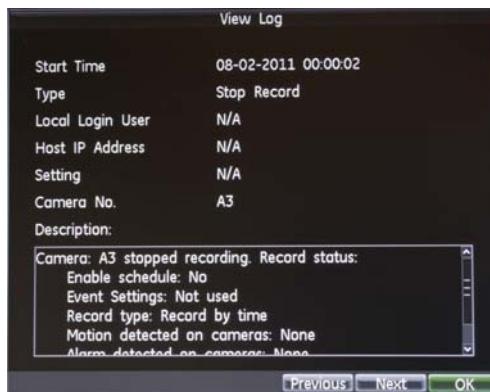

Configuring HDD alarms

HDD alarms can be set to trigger when an HDD is uninitialized or in an abnormal state.

To set HDD alarms:

1. Enter Notifications screen by selecting **Alarms** in the main menu, and then the Notification tab.



2. Select HDD Error in the Notification Type box.
3. Select a notification type. Notification types are explained in greater detail in “Description of alarm notification types” on page 88.

Chapter 16

Configuring the DVR settings

This chapter describes:

- Changing the language
- Managing users
- Updating system firmware
- Restoring default settings
- Viewing system information
- Viewing system logs

Changing the language

You can easily change the language of the system.

To change the language:

1. Enter the System View screen by selecting **System** in the main menu.
2. Click **Language** and from the drop-down list, select the desired language.
3. Click **Setup** and then **OK** to confirm the change.

The language displayed changes.

Managing users

By default the DVR comes with three user accounts: an Administrator account, a Manager account and an Operator account. These accounts provide multiple levels of access and functionality. There are four user levels: Administrator, Manager, Operator, and Custom.

See Table 20 below for a description of the different user accounts. See Table 21 on page 122 for the list of fixed and optional access privileges by user level.

Table 20: User accounts

User	Description
Administrator	<p>The administrator account includes extended menu with full access to all settings. The Administrator has the authority to add, delete or configure parameters for many of the system functions.</p> <p>There can only be one administrator.</p> <p>The user name is admin. The name cannot be modified.</p> <p>The default password is 1234.</p>
Manager	<p>The manager account includes reduced menu access to Video settings (inaccessible features that are not visible).</p> <p>The default user name is manager.</p> <p>The default password is 2222.</p>
Operator	<p>The operator account includes menu access with no programming possibilities (inaccessible features are not visible).</p> <p>The default user name is operator.</p> <p>The default password is 3333.</p>

Note: The default password should be changed for security reasons.

Adding a new user

Only a system administrator can create a user. You can add up to 31 new users.

Once created, you can customize the access privileges according to the needs of each Custom user. However, the access privileges of Manager and Operator level users are fixed. See “Customizing a user’s access” on page 121 for further information.

To add new users:

1. Enter the User Settings screen by selecting **User** in the main menu.
2. Click **Add** to enter the Add User screen.



3. Enter the following information for the new user: User Name, Password, Level and User’s MAC address.

Level refers to the user's level of access and can be set using one of the following predefined levels. These levels include privileges that are already defined and cannot be changed from this menu.

- Operator
- Manager
- Custom

However, the Custom level lets you select the user's access privileges. See "Customizing a user's access privileges" below for more information.

4. Enter the user's MAC address to let the user access the DVR from that particular MAC address.
5. Click **OK** to save your user.

Customizing a user's access privileges

You can allocate customized access privileges to Custom users depending on their needs. Some users, for example, may need to be able to configure more than the fixed privilege settings for a user level allow. See Table 21 on page 122 for the list of fixed privileges:

Only an administrator can allocate access privileges to users.

There are three types of privilege settings: Local, Network, and Camera.

The local settings include:

- **Local Log Search:** Search and view logs of the DVR.
- **Local Configuration:** Configure and restore parameters to factory defaults. Can also introduce settings to or export settings from the DVR.
- **Local Camera Management:** Enable and disable analog channels. Can also add and delete IP cameras.
- **Local Advanced Management:** Access HDD management (including the initialization and changing the properties of a disk). Update system firmware as well as to stop the relay output.
- **Local Shutdown/Reboot:** Shutdown or reboot the DVR.









The network settings include:













- **Network Log Search:** Remotely view logs that are saved on the DVR.
- **Network Configuration Parameters:** Remotely configure parameters, restore parameters to factory defaults and import settings to as well as export settings from DVR.
- **Network Camera Management:** Remotely enable and disable analog channels. Add and delete IP cameras.
- **Network Serial Ports:** Configure settings for the RS-232 port.
- **Network Allocating Video Output:** Configure settings for video output.
- **Two-Way Audio:** Use two-way radio between the remote client and the DVR.
- **Network Layout Alarm and Trigger Alarm Output:** Remotely alert or control the relay output of the DVR. Alarm and notification settings must be configured properly to upload to host.
- **Network Advanced Management:** Remotely manage hard disk drives (initializing and setting properties for HDDs) as well as remotely update system firmware and stop the relay output
- **Network Shutdown:** Remotely shutdown the DVR.

The camera settings include:

- **Network Live:** Select and view live video over the network.
- **Remote Record Starting:** Remotely start and stop manual recording on any of the channels.
- **Local Playback:** Locally play recorded files that are on the DVR.
- **Remote Playback:** Remotely play and download recorded files that are on the DVR.
- **Network PTZ Control:** Remotely control PTZ dome cameras.
- **Local Backup:** Locally back up recorded files from any of the channels.

Table 21: Fixed access privilege settings by user level

Privilege	User level			
	Administrator	Manager	Operator	Custom
Local settings:				
Local Log Search	X	X		
Local Configuration	X			
Local Camera Management	X			
Local Advanced Management	X			
Local Shutdown/Reboot	X	X		
Network settings:				
Network Log Search	X	X		
Network Configuration Parameters	X			
Network Camera Management	X			

Privilege	User level			
	Administrator	Manager	Operator	Custom
Network Serial Ports	X	X		
Network Allocating Video Output	X	X		
Two-Way Audio	X	X	X	
Network Layout Alarm and Trigger Alarm Output	X	X		
Network Advanced Management	X			
Network Shutdown	X	X		
Camera settings:				
Network Live	X	X	X	
Remote Record Starting	X	X		
Local Playback	X	X		
Remote Playback	X	X		
Network PTZ Control	X	X		
Local Backup	X	X		

Legend:

X = Fixed setting

 = Setting can be modified**To customize a user's access privileges:**

1. Enter the User Settings screen by selecting **User** in the main menu.

Note: The access privilege settings of Admin, Manager and Operator cannot be changed. Only those of Custom users can be changed.

2. Click **Add** to enter the Add User screen.



3. Select **Custom** in the Level box.
4. Click **Privilege** to enter the Privilege Settings screen.

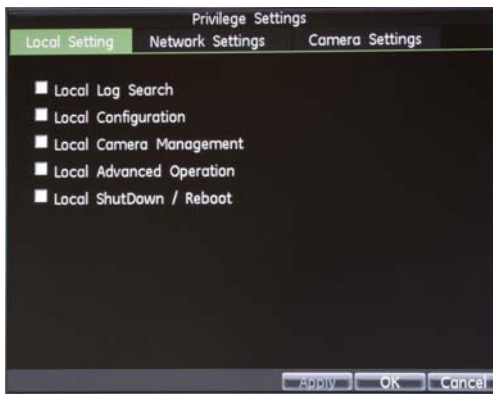

5. Configure privileges for local settings under the Local Settings tab and check the access privileges required.

Note: If you had selected Operator instead of Custom, this screen would be empty as operators by default do not have access privileges to these functions.

6. Click the Network Settings tab to configure network privileges.
7. Click the Camera Settings tab to configure camera privileges.



8. Click **OK** to save and exit the screen.

Note: If you forget the password to your DVR, contact your supplier with the serial number of your DVR to obtain a secure code to reset your DVR.

Deleting a user

Only a system administrator can delete a user.

To delete a user from the DVR:

1. Enter the User Settings screen by selecting **User** in the main menu.
2. Select the user to delete.
3. Click **Delete** to delete user.
4. Click the **OK** button to exit the screen.

Modifying a user

Only a system administrator can modify a user.

To modify a user:

1. Enter the User Settings screen by selecting **User** in the main menu.

Note: Only Custom level users can have their access privileges modified.

2. Select the user to modify.
3. Click **Edit** to enter the Edit screen.

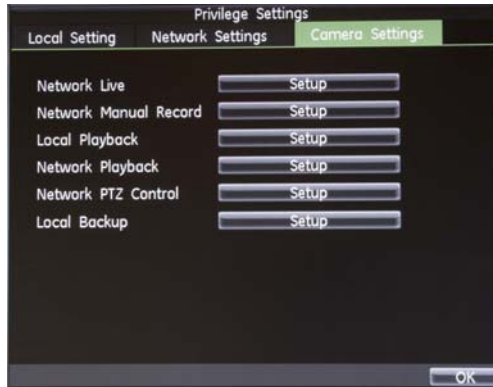

4. Edit the user information.
5. To modify user permissions, click Privileges. Privileges settings are defined in “Customizing a user’s access” on page 121.
6. Click the **OK** button to exit the screen.

Updating system firmware

The firmware on the DVR can be updated using four methods:

- Via an USB device
- Over the network via an FTP server
- Via the DVR Web browser
- Using TruVision Navigator. For further information, refer to the TruVision Navigator user manual.

The firmware upgrade file is labeled *TVR60.dav*.

To update the system firmware using a USB device:

1. Download on to a USB the latest firmware from our web site at:
www.gesecurityproducts.eu/videoupgrades

2. Connect the USB device to the DVR.
3. Enter the System View screen by selecting **System** in the main menu.
4. Click **Firmware Upgrade** to enter the Firmware screen.

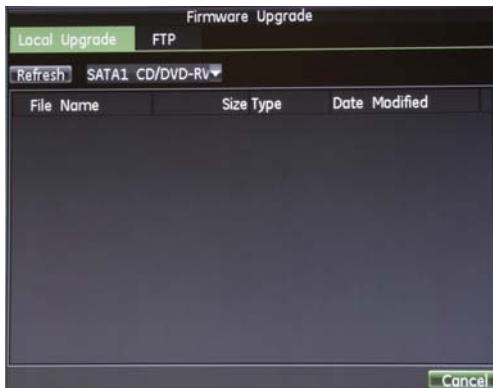

5. Click the Local Upgrade tab.
6. Select your USB device in the dropdown box.
7. Select the firmware on the USB device.
8. Click **Upgrade** to begin the upgrade process.
9. When the upgrade process completes, reboot the DVR.

To update via a FTP server:

1. Configure the PC (running FTP server) and DVR to be in the same Local Area Network. Run the third-party TFTP software on the PC and copy the firmware into the root directory of TFTP.
2. Enter the Firmware Update menu by selecting System in the main menu. The System View screen appears.
3. Click the FTP tab.

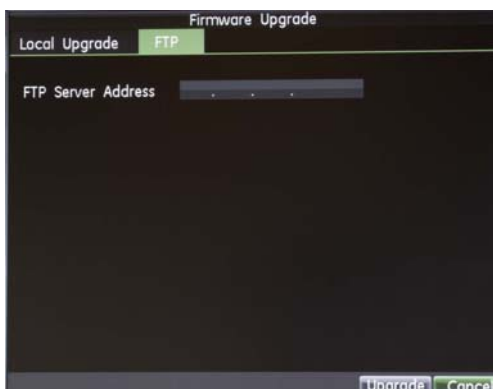

4. Enter the FTP server address.
5. Click **Upgrade** to begin update process.
6. When the update process completes, reboot the DVR.

Note: If the DVR fails to update, please contact your system supplier for further assistance.

Restoring default settings

To restore default factory settings to your DVR:

1. Enter the Default Settings menu by selecting **System** in the main menu, and then **Factory Default**.
2. Click **OK** to restore factory defaults.

Note: Network information such as IP address, subnet mask and gateway are not restored.

Viewing system information

To view system information:

1. Enter the Default Settings menu by selecting **System** in the main menu, and then **System Information**.
2. Click **OK** to exit to the previous screen.

Viewing system logs

Many events of the DVR are logged into the system logs.

To access the system logs and search for these events:

1. Enter the Default Settings menu by selecting **System** in the main menu, and then **View Log**.

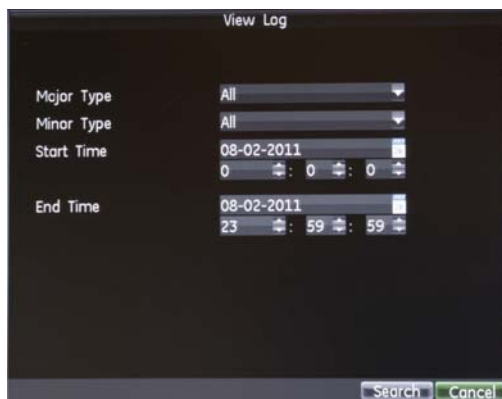

2. Enter search parameters.
3. Click **Search** to begin search.

If logs matching the search criteria are found, they are displayed in a result list.



- To view more detail information about a particular log entry, select the entry and click Details.
- If available, you can also view the associated video to the selected log entry by clicking Play.

Exporting log files

Log files can also be exported onto a USB device.

To export log files:

- Connect a USB device to the DVR.
- Go to the View Log screen, enter search parameters, and then click **Search**.
- Select the log file to export, and then click **Export**.
- This takes you to the Log Search Export screen, shown in the figure below.



- Click **Export** to export log onto USB device.

The exported file is named according to the time it was exported (i.e. tvr60.20100616.txt).

- Click **Cancel** to exit the menu.

Appendix A

Troubleshooting

Place the TVR 60 in well-ventilated space so that it operates within the allowed range of temperature and humidity as in specification.

If the circuit board is wet, dust on circuit board can cause a short circuit. The circuit board, plug and socket, housing fan and housing should be cleaned by brushing regularly.

Table 22: Troubleshooting FAQs

Failure	Possible reasons and actions to take
Why does the DVR make a beeping sound after booting?	The booting sound may be due to: <ol style="list-style-type: none">1. There is no HDD present in the DVR.2. The HDD has not been initialized. See "Using the Setup Wizard" on page 19.3. The HDD is defective. Please contact your local supplier.
Why does the DVR not responsive when using the remote control?	If the DVR not responsive when using the remote control and you have read through the section "Using the IR remote control" on page 26, please check: <ol style="list-style-type: none">1. Check that the batteries are installed correctly in the remote control.2. Check the remaining charge in the batteries.3. Check that the remote control sensor is not covered.4. Check the address setup in the DVR.
Why can the DVR not control the PTZ dome camera through the RS-485 port?	If the PTZ dome camera does not respond: <ol style="list-style-type: none">1. Check that the RS-485 cable is properly connected and undamaged.2. Check that the correct type of camera dome decoder is being used.3. Check that the camera dome parameters are correct.4. Check that the address bit configuration of the camera dome decoder is correct.5. Ensure that the main board RS-485 interface is not damaged. If damaged, please contact your local supplier.

Failure	Possible reasons and actions to take
Why is there no video recorded after setting the motion detection?	<p>If there is no recorded video after setting up for motion detection:</p> <ol style="list-style-type: none"> 1. Check that the recording schedule is setup correctly. See “Defining a recording schedule” on page 81. 2. Check that the motion detection area is configured correctly See “Motion detection” on page 87. 3. Check that camera channels are being triggered for motion detection. See “Motion detection” on page 87.
Why does the DVR not detect the USB export device for exporting recorded files?	The DVR and USB device may not compatible. Check that the USB drive is formatted FAT32.
The DVR is in live mode but the main menu does not appear. The DVR does not respond to the mouse, front panel, remote or keypad.	Your DVR may be in auxiliary mode. This occurs when the A/B monitor button has been pressed on the front panel. To return to the previous mode of operation, press the A/B monitor button again.

Appendix B

Specifications

Video	
Video format	PAL /NTSC (auto detected)
Conditioning	AGC, 0.7 to 1.4 Vp-p video accepted
Resolution (H × V)	PAL: 704 × 576 NTSC: 704 × 480
Video compression	H.264
Video input	16 channels
Monitor A VGA	Full and multiscreen output, VGA connector (Res. 800 x 600 @ 60 Hz), PAL/CCIR or NTSC/EIA compatible
Monitor B composite	Full and multi-screen output, BNC connector, PAL/CCIR or NTSC/EIA compatible
Monitor C composite	Spot Monitor for Alarms, BNC connector, NTSC/EIA or PAL/CCIR compatible
Multi-screen display	Full, quad, 1+5, 1+7, 9, and 16
Recording	
Hard drive	6-HDD SATA supporting SMART
Resolution	PAL: 4CIF (704 × 576), 2CIF (704 × 288), CIF (352 × 288) and QCIF (176 × 144) NTSC: 4CIF (704 × 480), 2CIF (704 × 240), CIF (352 × 240) and QCIF (176 × 120)
TVR 6016	400 fps 4CIF
Mode	TimeLapse, Event, Schedule
Audio	
Compression standard	OggVorbis, 16 Kbps
Input	16 channel, RCA
Output	2 RCA
Bi-directional - Line In	1 RCA
Video motion detection	
Zones per camera	396 zones per camera (22 x 18 grid)
Operation	
Operating system	VxWorks real-time OS

Languages	English, Czech, Danish, Dutch, Finnish, French, German, Greek, Hungarian, Italian, Polish, Portuguese European, Portuguese Brazilian, Russian, Slovakian, Spanish, Swedish, Turkish
Users	Admin, Manager, Operator & 13 additional users
Network	
Type	10/100/1000 Base-T, RJ-45
Protocol	TCP, IP, ARP, RARP, PPP, PPPoE, DHCP,SNMP
Others	ADSL modem for alarm video transmission
e-SATA	1
Archive	
Audio and video	Via built-in CD/DVD burner, USB2.0 or e-SATA
Connectors	
RS-232 serial port	9-pin Sub D
RS-485 PTZ control port	Screw terminal strip
USB	2, one at the front and one at the back
Keypad	Screw terminal strip
Alarm handling	
Alarm monitor	Mon A or B or C (configurable)
Alarm input	16 programmable NO/NC
Alarm output	Form C alarm relay (4)
Miscellaneous	
Input voltage	90 to 135 VAC / 180 to 256 VAC, 47 to 63 Hz
Power consumption	max 126 W
Operating temperature	-10 to +50°C (14 to 122°F)
Relative humidity	10 to 90%
Dimensions (W x H x D)	435 × 95 × 455 mm (19-inch (2U)
Weight	11 kg (24.2 lb)
Mounting	Rack mount kit optional
Thin Client requirements (Browser connection)	
Intel-based PC	1 GHz or faster
Memory	1 GB RAM minimum
Operating system	Windows® XP, Vista or Windows 7
DirectX	9.0 or later
Supported devices	
PDA/mobile phone	WinMobile 5 or higher, iPhone/iPad, Android
Touch Screen support	
Free memory at least 20MB	
CPU 200MHz and better	

Supported IP devices	Part code (SKU)
TruVision H.264 IP cameras	TVC-M1120-1-P
	TVC-M2110-1-P
	TVD-M1120-3-V-P
	TVD-M2110-3-V-P
	TVD-M2110-3-P
	TVC-M1120-1-N
	TVC-M2110-1-N
	TVD-M1120-3-V-N
	TVD-M2110-3-V-N
CamPlus2 IP cameras	GEC-IP2VD-DNP
	GEC-IP2D-P
	GEC-IP2B-P
	GEC-IP2VD-DN
	GEC-IP2D
	GEC-IP2B
UltraView IP cameras	UVD-IP-EVRDNR-VA2-P
	UVD-IP-EVRDNR-VA9-P
	UVD-IP-XP3DNR-VA2-P
	UVD-IP-XP3DNR-VA9-P
	UVC-IP-XP3DN-HR-P
	UVC-IP-EVRDN-HR-P
UltraView encoder	UVE-10
Panasonic cameras	NW484S
	NF284
	NP-244

Appendix C

PTZ protocols

AD	PELCO-P
BEWATOR-PELCO-D	PowerDome
BBV-RS422	Samsung
Bosch	Sanyo
DM (BBV)	Sensormatic
GE RS-485	Siemens
Honeywell	SONY-EVI-D100/P
HIKVISION	SONY-EVI-D70
LILIN	SONY-EVI-D30/31
LG MULTIX	Ultrak
PANASONIC_CS850	VCL
PELCO-D	Vicon

Appendix D



TVK-505U keypad

Using a TVK-505U keypad

Use the keypad to carry out functions similar to the front panel buttons. For detailed keypad instructions, refer to the TVK-505U controller keypad user manual.

Setting up a TVK-505U keypad to work with the TVR 60

To set up a TVK-505U keypad:

1. In the keypad live mode menu press the  or  button to select the DVR tab required.



2. Press the option **DVR**.
3. Enter the number of the DVR. The value must be between 0 and 255.
4. Press the  button to confirm.

The message, MASTER ENABLED, momentarily appears.

To access the programming menus of a PTZ dome camera using a TVK-505U keypad:

1. In the keypad live mode menu press the **PTZ** button.

Keypad enters PTZ mode.

Note: For information on programming a PTZ dome camera, please refer to the PTZ camera user manual.

Navigating the menus with the TVK-505U keypad

You can use the keypad joystick and keys to navigate through the menu system. See Figure 39 below. Please refer to the user manual for further information on their use.

Figure 39: Description of the TVK-505U keypad

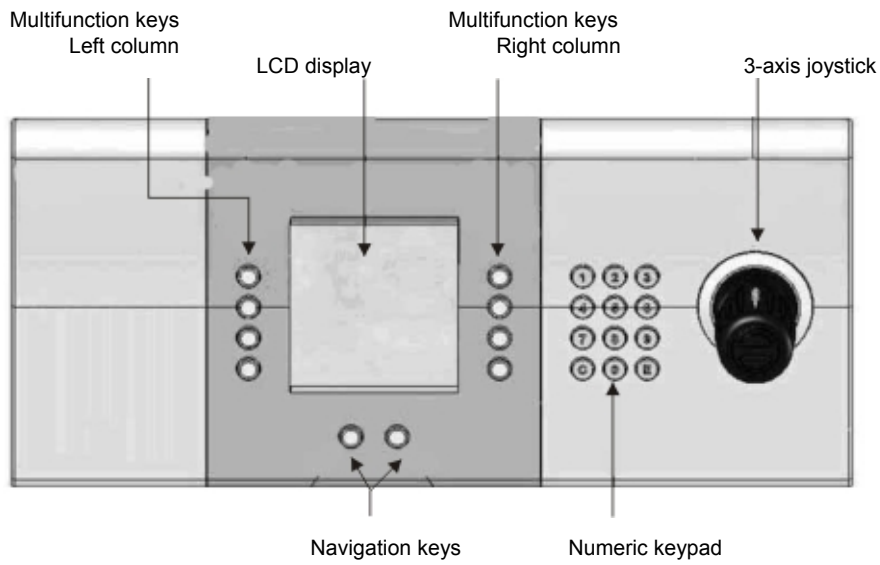

Appendix E

KTD-405 keypad

Supported firmware

TVR 6016-XXX firmware	4.0j or higher
KTD-405U (-2DU) keypad firmware:	1.4.10/1.4.00

Note: XXX is represents the DVR storage configuration such as 500 = 500 GB, 1T = 1 TB, etc.

Wiring the keypad

Connect the RS-485 bus of the KTD-405 I/O box to the TVR 60 Keypb A/B screw terminal port.

Table 23: Keypad and DVR connections

KTD-405 I/O box	TVR 60 connection
RS-485 A	Keyb A
RS-485 B	Keyb B

Figure 40: Keypad and DVR connections

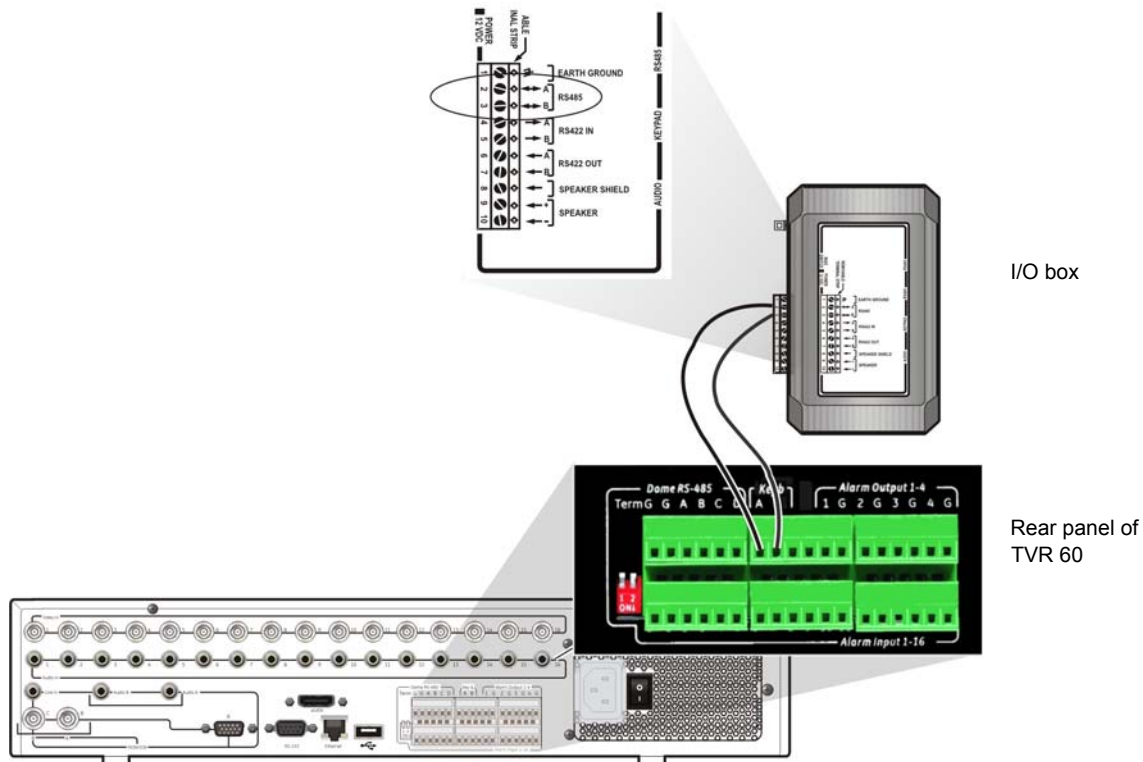

Setting up the keypad to work with the TVR 60

The keypad must be in zone mode to connect correctly with the TVR 60.

Further information on connecting and programming the KTD-405 keypad can be found in the user manual.

To set the keypad in zone mode:

1. Log into the keypad using the Admin password. Hold down the Enter button (↵) until a beep sounds and then enter the following code: **1 4 7 6**. Push the **seq** button to confirm.
2. Scroll through the menus with the **▶** button until this menu appears:

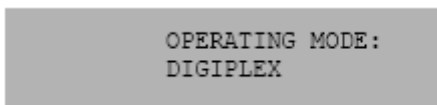

3. Change *Operating Mode* to *Zone* by moving the joystick down.
4. Quit the menu by pressing the **seq** button. The display will show, for example:

ZONE	--	ZONE TITLE
CAMERA	--	MONITOR

5. To connect it to the DVR, press the **zone** button and enter the ID number of the TVR 60. The default value is “1”.
6. To configure the DVR zone ID number, at the DVR enter the System View screen by selecting **System** in the main menu. Under Zone ID, enter the zone ID value. The default value is “1”.

Note: The zone ID value must be identical for the DVR and keypad.

The TVR 60 is now connected to the KTD-405 keypad.

To configure the TVR 60 device address:

1. Click the **Display** in the main menu and select the Monitor tab
2. Click the Device address edit box and enter a numeric value. The default address for the keypad is “1”. Click **Enter**

TVR 60 and keypad functions

The KTD-405U acts as a DVR control keypad when connected to the TVR 60. The keypad mimics many of the functions available from the front panel of the TVR 60.

Unavailable TVR 60 functions

The following TVR 60 functions are unavailable when using the keypad to control the TVR 60:

- Export video
- Eject CD/DVD
- Preset and shadow tour
- Select motion detection or tampering zones
- Archive records
- Capture video

If these functions are required, it is recommended to use a mouse in conjunction with the keypad as all TVR 60 functions will then be available.

Unavailable keypad functions

The following keypad buttons are unavailable when using the keypad to control the TVR 60:

Figure 41: Keypad buttons unavailable

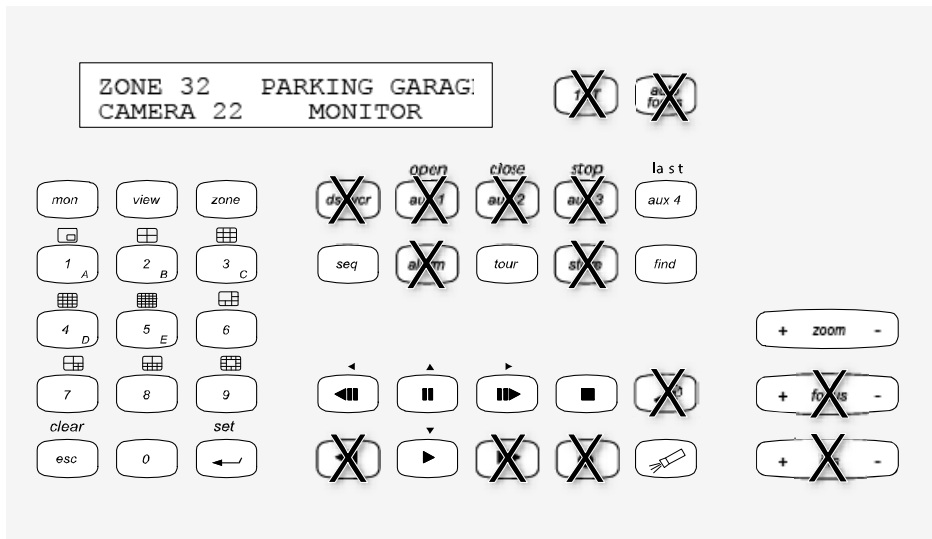

DSC/VCR	Autofocus	● (Record mode)
Aux 1	Alarm	Store
Aux 2	Iris +/-	▶▶ Fast forward
Aux 3	Focus +/-	◀◀ Fast backward
Ist	🔍 (Magnification)	

Operating the keypad

You can navigate the TVR 60 menus using the keypad buttons and joystick. However, not all maneuvers are available using the joystick.

See Table 24 on page 144 on page 143 for the description of the DVR keypad mapping when using the KTD-405 keypad series. See Figure 41 above for a list of the keypad functions that are unavailable when connected to the TVR 60.

Example 1: To enter your password in the login screen using the keypad

1. In live mode, press **esc** to activate the Login screen.
2. Press and hold **esc** and then press the arrow buttons (▶ down, ◀ up, ◀ left, ▶ right) to move the cursor to the Password edit box. Once in the password box, release **esc**.
3. Press **Enter** (↵) to activate the virtual keyboard.
4. Press and hold **esc** and then press the arrow buttons to reach the first digit of the password. Release **esc** and press **Enter** (↵) to select the digit.
5. Repeat steps 2 to 4 for each digit of the password.
6. Move the cursor to the Enter button on the virtual keyboard and press **esc** on the KTD-405 keypad to enter the password.

7. Press and hold **esc** and then press the arrow buttons to navigate the cursor to activate OK button on the Login screen.
8. Press **↵**. The main menu appears.

Example 2: To modify a menu option using the keypad















1. In the main menu press and hold **esc** and then press the arrow buttons to navigate to the desired menu icon (for example, Display).
2. Press **↵** to enter Display menu.







3. Press **▶** or **◀** to scroll to the menu tab, Layout.
4. When in the desired menu screen, press and hold **esc** and then press the arrow buttons (**⏪** up, **⏩** down) to navigate the cursor to the option, Layout Mode.
5. Press **↵** to activate the dropdown menu.
6. Press and hold **esc** and then press the up/down arrow buttons to navigate to the desired option.
7. Press **↵** to select the option.
8. Press and hold **esc** and then press the up/down arrow buttons to navigate to Apply. Press **↵** to select it. Then navigate to OK and select it too.

TVR 60 mapping to the KTD-405 keypad

Table 24: TVR 60 mapping to the KTD-405 keypad

Task	Keypad action	Further information
• Menu mode		
Call up or exit menu	In live view, press esc .	
Move through the menus	Press and hold esc and then press the arrow buttons.	 Down,  Up,  Left,  Right
Move between menu tabs	Press  or  to switch between menu tabs.	
Navigate to a menu option	Press and hold esc and then press the arrow buttons.	 Down,  Up,  Left,  Right
Select a character or menu option	Press Enter ().	Note. If you press esc before pressing Enter , you quit the menu without saving any changes. It is the same as cancel.
Select the zone ID	Press zone to connect the keypad to the DVR.	
• Live mode		
Call up a single camera	Press 0 to 9 and then press Enter ().	Using the numeric buttons 0 to 9 , enter the number of the camera and then press Enter ().
Call up multiview screens	Press view and then continue to press button 5 to scroll through the options available.	
Sequence through cameras	Press the seq button to scroll through the cameras in full screen.	
Sequence through multiview screens	Press and hold esc and then press the left/right arrow buttons	
Switch between monitor A and monitor B	Press the mon button and button 1 to switch to monitor A. Press the mon button and button 2 to switch to monitor B.	To return to the previously selected monitor, you must deselect the current monitor by re-entering the combination again. So to return to monitor B, press mon 1 to return to monitor B, or press mon 2 to return to monitor A, Note: The keypad display will always indicate monitor A even when monitor B is selected.
Manually acknowledge an alarm	Press Alarm .	
• PTZ functions		
Enter PTZ mode	In live mode, press Enter ().	
PTZ functions (Up, Down, Left, Right, Zoom in, Zoom out)	Move the joystick to move the dome up, down, left and right Press zoom+ and zoom- .	KTD-405U: Turn the knob on the joystick to zoom in/zoom out. KTD-405-2DU: Press the zoom+ and zoom- buttons.
Leave PTZ mode	Press esc .	

Task	Keypad action	Further information
• Playback functions		
Search for recorded video	Press 	Once password is entered, the Advanced Search menu appears.
Instant playback	Press  when in full screen.	Instant playback of the currently selected camera. Default time is 1 minute. Other cameras listed on-screen can only be accessed using the mouse.
Stop playback	Press  to stop playback and return to live mode.	
Pause playback	Press  to pause playback. Press  to restart.	
Replay the current file.	press aux4 to replay the current file.	Starts at the beginning of the file.
Change playback speed	Press and hold esc and then press the left/right arrow buttons	
Jump 30 seconds forwards or backwards during playback	Press and hold esc and then press the up/down arrow buttons	

Selecting an IP camera using the keypad

The TVR 60 can support up to 16 analog and eight 4-CIF IP cameras. To be able to control up to 24 cameras using the keypad, you may need to change the number of TVR 60 camera inputs controlled by the keypad. The default number of TVR 60 camera inputs controlled by the keypad is 16.

To change the number of TVR 60 camera inputs controlled by the keypad:

1. Hold down the Enter button (↵) until a beep sounds and then enter the following code: **1 4 7 6**. Push the **seq** button to confirm.
2. Scroll through the menus with the  button until this menu appears:

```
ENTER ZONE ADDRESS: 01
(01-32)                <<NEXT>>
```

3. Enter the DVR address to be configured and press ↵.
4. Scroll through the menus with the  button until this menu appears:

```
ZONE 01 HUB:          DVMRE DUP
(↑, ↓)=SELECT        <<NEXT>>
```

5. Press the up/down arrow buttons to navigate to SYM DVR.
6. Scroll through the menus with the  button until this menu appears:

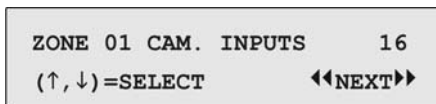

7. Press the up/down arrow buttons to navigate to 32.
8. Repeat steps 3 to 7 for each DVR address in the keypad.

Controlling a camera

When setting up and controlling your cameras in zone mode, refer to Table 25 below for the list of default PTZ addresses associated with a zone ID. This value is automatically populated in the system. You can modify the PTZ address in the PTZ menu to meet customer requirements (see “Configuring PTZ settings” on page 47.).

Table 25: Default PTZ camera addresses by zone ID

Camera input	Zone ID of TVR 60															
	1	2	3	4	5	6	7	8	9	10	11	12	13	14	15	16
1	0	32	64	96	128	160	192	224	256	288	320	352	384	416	448	480
2	1	33	65	97	129	161	193	225	257	289	321	353	385	417	449	481
3	2	34	66	98	130	162	194	226	258	290	322	354	386	418	450	482
4	3	35	67	99	131	163	195	227	259	291	323	355	387	419	451	483
5	4	36	68	100	132	164	196	228	260	292	324	356	388	420	452	484
6	5	37	69	101	133	165	197	229	261	293	325	357	389	421	453	485
7	6	38	70	102	134	166	198	230	262	294	326	358	390	422	454	486
8	7	39	71	103	135	167	199	231	263	295	327	359	391	423	455	487
9	8	40	72	104	136	168	200	232	264	296	328	360	392	424	456	488
10	9	41	73	105	137	169	201	233	265	297	329	361	393	425	457	489
11	10	42	74	106	138	170	202	234	266	298	330	362	394	426	458	490
12	11	43	75	107	139	171	203	235	267	299	331	363	395	427	459	491
13	12	44	76	108	140	172	204	236	268	300	332	364	396	428	460	492
14	13	45	77	109	141	173	205	237	269	301	333	365	397	429	461	493
15	14	46	78	110	142	174	206	238	270	302	334	366	398	430	462	494
16	15	447	79	111	143	175	207	239	271	303	335	367	399	431	463	495
17	16	48	80	112	144	176	208	240	272	304	336	368	400	432	464	496
18	17	49	81	113	145	177	209	241	273	305	337	369	401	433	465	497
19	18	50	82	114	146	178	210	242	274	306	338	370	402	434	466	498
20	19	51	83	115	147	179	211	243	275	307	339	371	403	435	467	499
21	20	52	84	116	148	180	212	244	276	308	340	372	404	436	468	500
22	21	53	85	117	149	181	213	245	277	309	341	373	405	437	469	501
23	22	54	86	118	150	182	214	246	278	310	342	374	406	438	470	502
24	23	55	87	119	151	183	215	247	279	311	343	375	407	439	471	503
25	24	56	88	120	152	184	216	248	280	312	344	376	408	440	472	504
26	25	57	89	121	153	185	217	249	281	313	345	377	409	441	473	505

Camera input	Zone ID of TVR 60															
	1	2	3	4	5	6	7	8	9	10	11	12	13	14	15	16
27	26	58	90	122	154	186	218	250	282	314	346	378	410	442	474	506
28	27	59	91	123	155	187	219	251	283	315	347	379	411	443	475	507
29	28	60	92	124	156	188	220	252	284	316	348	380	412	444	476	508
30	29	61	93	125	157	189	221	253	285	317	349	381	413	445	477	509
31	30	62	94	126	158	190	222	254	286	318	350	382	414	446	478	510
32	31	63	95	127	159	191	223	255	287	319	351	383	415	447	479	511

Appendix F

Camera matrix

Table 26: Matrix of the number of analog and IP cameras that can be used

Analog (4CIF)	IP SD (4CIF)	UltraView Camera (4CIF)	IP HD 720p (1280x720)	IP HD 2MPX (UXGA - 1600x1200@1 2.5fps max)	Max. Amt of cameras connected
16	8				24
16	4		2		22
16	4			2	22
16			4		20
16			2	2	20
16				4	20
16		8			24

Analog (4CIF)	IP SD (4CIF)	UltraView Camera (4CIF)	IP HD 720p (1280x720)	IP HD 2MPX (UXGA - 1600x1200@1 2.5fps max)	Max. Amt of cameras connected
14	9				23
14	5		2		21
14	5			2	21
14	1		4		19
14	1		2	2	19
14	1			4	19
14		9			23

Analog (4CIF)	IP SD (4CIF)	UltraView Camera (4CIF)	IP HD 720p (1280x720)	IP HD 2MPX (UXGA - 1600x1200@1 2.5fps max)	Max. Amt of cameras connected
12	10				22
12	6		2		20
12	6			2	20
12			5		17
12			1	4	17
12	2			4	18
12		10			22

Analog (4CIF)	IP SD (4CIF)	UltraView Camera (4CIF)	IP HD 720p (1280x720)	IP HD 2MPX (UXGA - 1600x1200@1 2.5fps max)	Max. Amt of cameras connected
10	11				21
10	5		3		18
10	7			2	19
10	1		5		16
10	3		2	2	17
10	1		1	4	16
10		11			21

Analog (4CIF)	IP SD (4CIF)	UltraView Camera (4CIF)	IP HD 720p (1280x720)	IP HD 2MPX (UXGA - 1600x1200@1 2.5fps max)	Max. Amt of cameras connected
8	12				20
8	6		3		17
8	6		1	2	17
8			6		14
8			2	4	14
8				6	14
8		12			20

Analog (4CIF)	IP SD (4CIF)	UltraView Camera (4CIF)	IP HD 720p (1280x720)	IP HD 2MPX (UXGA - 1600x1200@1 2.5fps max)	Max. Amt of cameras connected
6	13				19
6	7		3		16
6	7		1	2	16
6	1		6		13
6	1		2	4	13
6	1			6	13
6		13			19

Analog (4CIF)	IP SD (4CIF)	UltraView Camera (4CIF)	IP HD 720p (1280x720)	IP HD 2MPX (UXGA - 1600x1200@1 2.5fps max)	Max. Amt of cameras connected
4	14				18
4	8		3		15
4	2			6	12
4			7		11
4			1	6	11
4	2			6	12
4		14			18

Analog (4CIF)	IP SD (4CIF)	UltraView Camera (4CIF)	IP HD 720p (1280x720)	IP HD 2MPX (UXGA - 1600x1200@1 2.5fps max)	Max. Amt of cameras connected
2	15				17
2	9		3		14
2	7			4	13
2	1		7		10
2	1		1	6	10
2	1		2	5	10
2		15			17

Analog (4CIF)	IP SD (4CIF)	UltraView Camera (4CIF)	IP HD 720p (1280x720)	IP HD 2MPX (UXGA - 1600x1200@1 2.5fps max)	Max. Amt of cameras connected
0	16				16
0	8		4		12
0	8			4	12
0			8		8
0				8	8
0				8	8
0		16			16

Appendix G

Glossary

Term	Definition
Data redundancy	Writing data to two or more locations for backup and data recovery. For example, data can be stored on two or more HDDs.
DDNS	Dynamic DNS is a method, protocol, or network service that provides the capability for a networked device, such as a router or computer system using the Internet Protocol Suite, to notify a domain name server to change, in real time (ad-hoc) the active DNS configuration of its configured hostnames, addresses or other information stored in DNS
DHCP	Dynamic Host Configuration Protocol (DHCP) is a network application protocol used by devices (DHCP clients) to obtain configuration information for operation in an Internet Protocol network
Dual Stream	Dual stream is a technology used to record high resolution video locally while transmitting a lower resolution stream over the network. The two streams are generated by the DVR, with the main stream having a maximum resolution of 4CIF and the sub-stream having a maximum resolution of CIF.
DVR	Acronym for Digital Video Recorder. A DVR is device that is able to accept video signals from analog cameras, compress the signal and store it on its hard drives
HDD	Acronym for Hard Disk Drive. A storage medium which stores digitally encoded data on platters with magnetic surfaces
HTTP	Acronym for Hypertext Transfer Protocol. A protocol to transfer hypertext request and information between servers and browsers over a network
Hybrid DVR	A hybrid DVR is a combination of a DVR and NVR
NTP	Acronym for Network Time Protocol. A protocol designed to synchronize the clocks of computers over a network.
NTSC	Acronym for National Television System Committee. NTSC is an analog television standard used in such countries as the United States and Japan. Each frame of an NTSC signal contains 525 scan lines at 60Hz
NVR	Acronym for Network Video Recorder. An NVR can be a PC-based or embedded system used for centralized management and storage for IP cameras, IP Domes and other DVRs.
PAL	Acronym for Phase Alternating Line. PAL is also another video standard used in broadcast televisions systems in large parts of the world. PAL signal contains 625 scan lines at 50Hz.
PPPoE	Point-to-Point Protocol over Ethernet, is a network protocol for encapsulating Point-to-Point Protocol (PPP) frames inside Ethernet frames. It is used mainly with ADSL services where individual users connect to the ADSL transceiver (modem) over Ethernet and in plain Metro Ethernet network.

Term	Definition
PTZ	Acronym for Pan, Tilt, Zoom. PTZ dome cameras are motor driven systems that allow the camera to pan left and right, tilt up and down and zoom in and out
USB	Acronym for Universal Serial Bus. USB is a plug-and-play serial bus standard to interface devices to a host computer.

Index

A

- Active X, 71
- Alarm indicator bar on front panel
- Alarm notifications
 - external alarms, 92
 - motion detection, 89
 - notification types, 88
 - video loss, 96
 - video tampering, 97
- Alarm outputs
 - manually acknowledging, 94
- Analog cameras, 105
 - configuring OSD settings, 108
 - enabling and disabling, 106
 - privacy masking, 109
- Archiving
 - archiving video clips, 68
 - exporting files to a backup device, 66
 - quick archive, 65
- Audio
 - connecting audio inputs and outputs, 15
- Audio output
 - enable/disable, 42
 - shortcut access to enable/disable, 37

C

- Cameras
 - adjusting brightness, contrast and saturation, 110
 - configuring PTZ dome cameras, 47
 - connecting analog cameras using loop-through, 15
 - enabling and disabling analog cameras, 106
 - number of cameras supported, 105
 - privacy masking, 109
 - setting up sequencing, 44

D

- Date
 - configuring display, 41
- Default settings
 - restore, 127
- Digital zoom, 34

- description, 33
 - shortcut access, 37
- DVR name and address
 - configuring display, 40
- Dwell time, 42

E

- E-mail notifications, 103
- External alarm
 - setting up to record when triggered, 92

F

- Factory default settings
 - restore, 127
- Firmware
 - updating, 125
- Front panel
 - description, 24
- Full screen viewing, 36

H

- HDD
 - capacity, 6
 - checking status, 116
 - grouping, 114
 - initializing, 113
 - redundancy, 84
 - setting to read-only, 114
 - setting up HDD alarms, 117
 - setting up HDD redundancy, 115

I

- Image, 37
- Instant playback, 60
 - changing replay time period, 42
- IP cameras, 105
 - changing IP address, 107
 - changing the camera inputs controlled by the keypad, 145
 - installing, 107
 - password, 107
- IP devices supported, 133

K**Keypad**

- access PTZ dome camera menus, 137
- accessing DVR using KTD-405 keypad, 142
- connecting dome cameras to the DVR, 8
- connecting to RS-485 port, 14
- controlling a camera with KTD-405, 146
- controlling KTD-405, 141
- navigating TVR 60 menus, 138
- set up TVK-505 with TVR 60, 137
- unavailable KTD-405 functions, 141
- use virtual keyboard, 30
- using KTD-405 in zone mode, 140
- wiring KTD-405 to TVR 60, 139
- wiring to DVR, 12

KTD-405

- changing the camera inputs controlled by the keypad, 145

KTD-405 keypad

- accessing DVR functions, 142
- controlling, 141
- controlling a camera, 146
- firmware supported, 139
- set up in zone mode, 140
- set up TVR 60 device address, 140
- unavailable keypad functions, 141
- unavailable TVR 60 functions, 141
- wiring to TVR 60, 139

L**Language, 20**

- changing, 119

Live dual streaming, 77**Live mode**

- configuring display, 39
- configuring time and date display, 41
- description, 33
- digital zoom, 33
- full screen view, 36
- multiscreen view, 36
- sequencing cameras, 37
- switch monitors, 34
- using KTD 405 keypad, 144

Logs

- export to USB, 128
- view system log, 127

M**Main menu**

- accessing, 29
- description, 29

Monitors

- configuring image, 39, 41
- connecting, 15
- description, 34
- selecting main and spot monitors, 42

- sequencing cameras, 42

- switch monitors, 34

Motion detection, 87

- defining motion detection area, 87
- setting the sensitivity level, 87
- setting the target size, 87

Mouse

- using, 25

Mouse pop-up menu

- live mode pop-up menu, 35
- PTZ pop-up menu, 49

Multiscreen layout

- selecting default, 42

Multiscreen viewing, 36**N****Network settings**

- DDNS, 100
- HTTP ports, 102
- multicast, 102
- NTP server, 101
- remote alarm host, 101
- server, 102
- setting up, 99

Notifications

- alarm types, 88
- external alarms, 92
- system event types, 95

P**Password**

- changing user password, 125
- default user passwords, 119
- enabling to gain access to DVR functions, 41

Playback, 55, 56

- changing playback speed, 62
- from system log, 61
- instant playback, 60
- playing back archived files, 69
- search results listed, 57
- using KTD 405 keypad, 145
- using the Web browser, 75
- video search, 58

Playback control panel

- description, 56

Player

- using for playback, 69

Power up and down DVR, 19**Preset position**

- calling up, 53
- selecting, setting up and deleting, 50

Preset tour

- calling up, 54

Protecting recorded files, 83**PTZ dome cameras**

- assigning protocols, 48
- configuring, 47

- connecting dome cameras to the DVR, 8
 - connecting to RS-485 port, 14
 - controlling using the Web browser, 77
 - mouse pop-up menu, 49
 - setup, 8
- PTZ mode
 - accessing, 49
 - shortcut access, 37
 - using KTD 405 keypad, 144
- PTZ protocols
 - assigning, 48
 - configuring Interlogix cameras, 9
 - list, 135
- R**
- Rear panel
 - connecting devices, 6
- Recording
 - configuring settings, 79
 - protecting recordings, 83
 - recording schedules, 81
 - setting up HDD redundancy, 84
- Recording schedules
 - defining, 81
- Remote control
 - connect to DVR, 28
 - description, 26
- S**
- Sequencing cameras, 37, 44
- Setup Wizard
 - using, 19
- Shadow tour
 - calling up, 54
 - setting up, 52
- SMART information
 - viewing, 116
- System information
 - view, 127
- System logs
 - view, 127
- System notifications
 - e-mail set up, 103
 - event types, 95
 - notification alarm types, 95
- T**
- Time
 - configuring display, 41
- TruVision IP cameras, 107
- TVK-505U keypad, 137
 - access PTZ dome camera menus, 137
 - navigating TVR 60 menus, 138
 - set up with TVR 60, 137
- U**
- UltraView, 107
- User privileges
 - descriptions, 121
- Users
 - adding a new user, 120
 - customizing user privileges, 121
 - deleting a user, 124
 - managing, 119
 - modifying user information, 125
 - user levels, 119
- V**
- Video loss
 - setting up detection, 96
- Video snapshot
 - capture, 75
- Video tampering
 - setting up to detect, 97
- View log, 116
- View system log, 127
- W**
- Web browser
 - accessing, 72
 - installing Active X, 71
 - live dual streaming, 77
 - local configuration of DVR, 74
 - remote configuration of DVR, 74
 - searching and playing back recorded video, 75
 - searching for event logs, 77
 - video snapshot, 75
 - Windows Vista and 7 security issues, 71
- Z**
- Zoom in/out on a camera image, 34

Menu map

