

1. SAFETY PRECAUTIONS .....	23
2. INTENDED USE OF THE REFRIGERATOR .....	23
3. INSTALLATION AND CONNECTION .....	24
3.1 Choosing the site .....	24
3.2 Positioning and levelling the appliance .....	24
3.3 Electrical connection .....	24
4. PRODUCT DESCRIPTION .....	25
4.1 FAB 28 .....	25
4.2 FAB 30 – FA311X/XS – FAB310X/XS .....	25
4.3 FAB 32 .....	26
4.4 Shelves .....	26
4.5 Bottle shelf .....	26
4.6 Refrigerator compartment defrosting water drain .....	26
4.7 Fruit and vegetable box .....	26
4.8 Door shelves and containers .....	26
4.9 Cheese box .....	27
4.10 Inside lighting .....	27
4.11 Fan (on some models only) .....	27
5. ARRANGING FOODS INSIDE THE REFRIGERATOR COMPARTMENT .....	28
6. SETTING AND SELECTING THE OPERATING TEMPERATURE .....	28
7. SETTING AND SELECTING THE FREEZER COMPARTMENT OPERATING TEMPERATURE .....	29
7.1 Refrigerator without intensive cooling switch .....	29
7.2 Refrigerator with intensive cooling switch .....	29
7.3 Refrigerator with intensive freezing switch and cooling system. ....	29
7.4 Refrigerator with rapid freezing function FAB32 .....	29
8. FREEZING FOODS .....	31
8.1 Storing frozen foods .....	31
8.2 Thawing frozen foods .....	32
8.3 Making ice-cubes .....	32
9. MAINTENANCE AND CLEANING .....	33
9.1 Defrosting the refrigerator compartment .....	33
9.2 Defrosting the freezer .....	33
9.3 Cleaning the refrigerator .....	33
9.4 Switching off the refrigerator .....	33
9.5 Practical advice for saving energy .....	34
9.6 Operating noise .....	34
9.7 Identifying and Dealing with Malfunctions .....	34
9.8 Changing the inside light bulb .....	34
10. TROUBLESHOOTING GUIDE .....	35

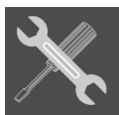

**INSTRUCTIONS FOR THE USER:** these provide recommendations for use, a description of the controls and the correct procedures for cleaning and maintaining the appliance



**INSTRUCTIONS FOR THE INSTALLER:** these are intended for the **qualified engineer** who is to install, commission and test the appliance

### DISPOSAL INSTRUCTIONS – OUR ENVIRONMENT POLICY

Our refrigerators are only packaged using non-pollutant, environment-friendly, recyclable materials. We urge you to cooperate by disposing of the packaging properly. Contact your local dealer or the competent local organisations for the addresses of collection, recycling and disposal facilities.

Never leave all or part of the packaging lying around. Packaging parts, and especially plastic bags, may represent a suffocation hazard for children.

Your old appliance must also be disposed of properly.

**Important** deliver the appliance to your local organisation authorised to collect scrapped appliances. Proper disposal allows the intelligent recovery of valuable materials. Refrigeration appliances contain gases which may damage the environment; it is important to ensure that the refrigeration circuit pipelines are not damaged until the competent service has taken delivery of the appliance.

Before scrapping your refrigerator it is important to remove doors and leave shelves in position as for use, to ensure that children cannot accidentally become trapped inside during play. Also, cut the power supply lead and remove it and the plug.



THIS APPLIANCE IS MARKED ACCORDING TO THE EUROPEAN DIRECTIVE 2002/96/EC ON WASTE ELECTRICAL AND ELECTRONIC EQUIPMENT (WEEE).

THIS GUIDELINE IS THE FRAME OF A EUROPEAN-WIDE VALIDITY OF RETURN AND RECYCLING ON WASTE ELECTRICAL AND ELECTRONIC EQUIPMENT.

## 1. SAFETY PRECAUTIONS

Keep the instruction handbook in a safe place; it contains important information which must be applied when installing, using and servicing the refrigerator. The handbook must be kept so that it can be passed on to any subsequent owners of the appliance.

The manufacturer declines all responsibility in case of failure to comply with the following precautions:

- Never put a damaged appliance into operation: if in doubt, contact your dealer.
- The appliance must be installed and connected to the electrical mains in full compliance with the instructions provided in the handbook. The electrical connection conditions must be as specified on the nameplate , **which is in the bottom left-hand corner of the body of the refrigerator**. The appliance's electrical safety is only guaranteed if the household electrical system is earthed in accordance with the relevant regulations.
- Make sure that all repairs and servicing are only carried out **by authorised engineers from the Smeg after-sales service**. Always disconnect the appliance from the electrical mains in case of breakdown and maintenance, when changing light-bulbs or during cleaning. Never defrost using electrical devices or steam cleaners. Never remove frost or ice with sharp items, **as this may cause irreparable damage to the walls of the refrigerator**.
- Never attempt to move the refrigerator by pulling on the door or the handle.
- High-alcohol drinks must only be stored sealed and vertical. Never store liquids in cans or glass containers in the freezer compartment, especially if they contain added carbon dioxide. Never store products containing gases, flammable propellants or explosive substances in the freezer: explosion hazard!
- The use of electrical appliances (such as ice-cream makers or whisks) inside the appliance is forbidden.
- To ensure the refrigerator operates correctly, never obstruct or cover the air ducts in any way.
- Never touch frozen products taken straight from the freezer or put them in your mouth. Burn hazard due to the very low temperatures.
- Never eat or drink foods which look or smell strange.
- This appliance is not suitable for use by persons (including children) with reduced physical, sensory or mental capacity, or by those without experience or knowledge, unless they are supervised or instructed on the use of the appliance by a person responsible for their safety.
- Children must be supervised to ensure that they do not play with the appliance.

In case of electricity blackout, open the door(s) as little as possible. Once partly or completely thawed, frozen foods must not be re-frozen.



### **Warning:**

**this refrigerator contains isobutane (R600a); this refrigerant gas is CFC-free but combustible. When transporting, installing, cleaning and repairing the refrigerator, take care not to damage any parts of the refrigeration circuit to prevent the risk of gas leaks. In case of damage, do not use naked lights and ventilate the room containing the appliance appropriately.**

## 2. INTENDED USE OF THE REFRIGERATOR

The appliance is specifically constructed for domestic use and is therefore suitable for the refrigeration and storage of fresh and frozen foods and the production of ice-cubes. The appliance has not been designed or manufactured for professional use. Smeg declines all responsibility for damage deriving from improper use of the appliance. The refrigerator has undergone the necessary tests on the tightness of the refrigeration circuit and complies with the safety regulations for electrical appliances.



### **Warning:**

**the manufacturer declines all responsibility for injury or damage caused by failure to comply with the above regulations or deriving from tampering with even just one part of the appliance and the use of non-original spare parts.**



### 3. INSTALLATION AND CONNECTION

#### 3.1 Choosing the site

Always place the refrigerator in a dry place with satisfactory ventilation. Never expose it to direct sunlight or install it outdoors. Depending on its climate class (stated on the nameplate inside the refrigerator compartment), the appliance can be used in different temperature conditions:

Class	Ambient temperature
SN (Subnormal)	from +10°C to +32°C
N (Normal)	from + 16° C to + 32° C
ST (Subtropical)	from + 18° C to + 38° C
T (Tropical)	from + 18° C to + 43° C

Never place the refrigerator close to heat sources. If this is unavoidable, a suitable insulating panel must be used to allow the appliance to function properly. Otherwise, place the appliance at least 3 cm from electric or gas cookers and at least 30 cm from combustion or radiation heating systems.

To allow proper cooling of the condenser, the refrigerator must not be placed too close to the wall. To prevent this, the appliance comes complete with two plastic spacers which must be fitted to the top of the condenser. If the refrigerator is installed underneath a wall cupboard, the distance between the two must be at least 5 cm.

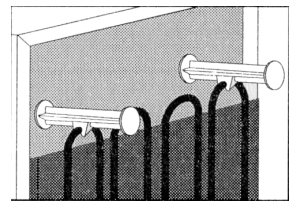

Take care not to scratch or damage the floor when installing the appliance on parquet or linoleum. If necessary, when positioning slide the refrigerator over pieces of wood or a mat to the point decided for connection to the electrical mains.

#### 3.2 Positioning and levelling the appliance

Place the fridge on a stable and level floor. In case the floor is not perfectly level, use the two adjustable feet on the front part of the fridge (pict. 1). To ensure major stability, easier movement and a correct positioning of the product, two additional wheels (pict. 2) are present at the rear. In any case we recommend to move the fridge very carefully in order to avoid floor damage (especially in case of wooden floor).

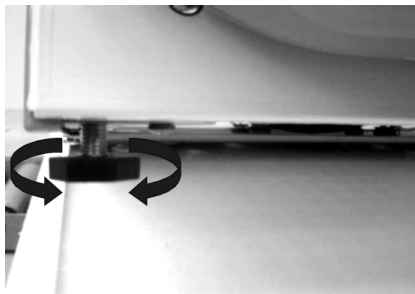

1)

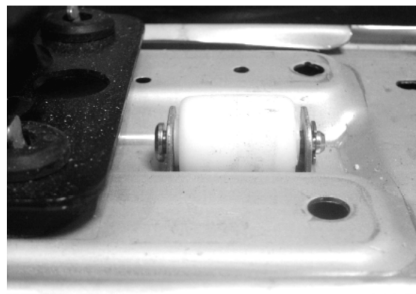

2)

#### 3.3 Electrical connection

Before switching the refrigerator on for the first time, leave it vertical for at least two hours. Then connect the appliance's power supply lead to a mains socket with earth contact, installed in accordance with electrical safety regulations. The rated voltage and frequency are stated on the nameplate inside the refrigerator compartment. The appliance must be connected to the electrical mains and earthed in compliance with the relevant regulations and requirements. The appliance is able to withstand short fluctuations in voltage of no more than 15% less or 10% more than the rated voltage stated on the nameplate. If the power supply lead has to be replaced, this operation must only be carried out by an **authorised Smeg technical service engineer**.

The socket must be accessible after the appliance has been placed.



## 4. PRODUCT DESCRIPTION

### 4.1 FAB 28

**Refrigerator (A):** compartment for storing fresh foods

**Freezer compartment (B):** compartment for storing frozen foods and for freezing fresh foods.

To open the door, pull the handle towards you. (see diagram below)

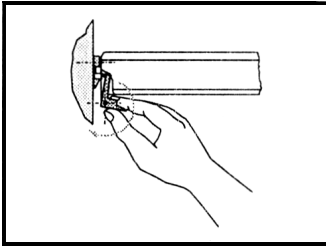

To close, push the door towards its hook and check that it snaps shut.

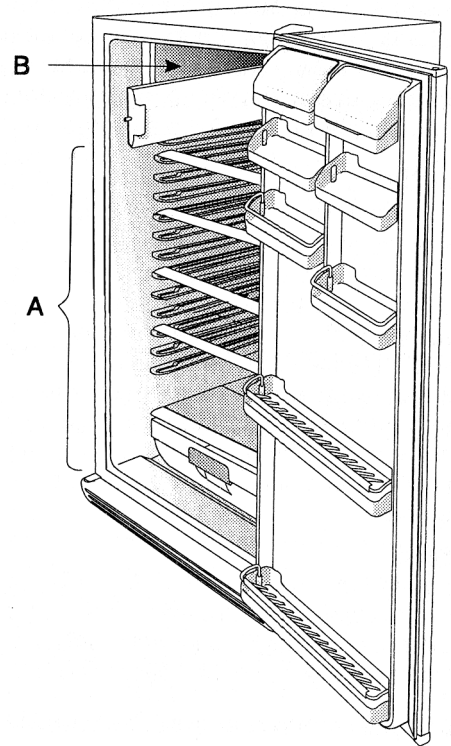

### 4.2 FAB 30 – FA311X/XS – FAB310X/XS

**Refrigerator (A):** compartment for storing fresh foods

**Freezer compartment (B):** compartment for storing frozen foods and for freezing fresh foods.

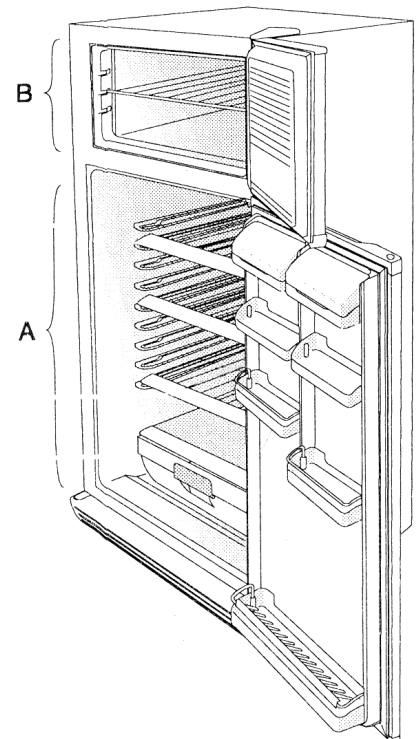



### 4.3 FAB 32

**Refrigerator (A):** compartment for storing fresh foods

**Freezer compartment (B):** compartment for freezing frozen foods. The various foods can be placed in the baskets provided. The bottom of the compartment has a channel (D) for collecting and draining the water generated by defrosting (see "Maintenance and Cleaning").

**Control panel (C):** external controls for regulating the freezer's operation

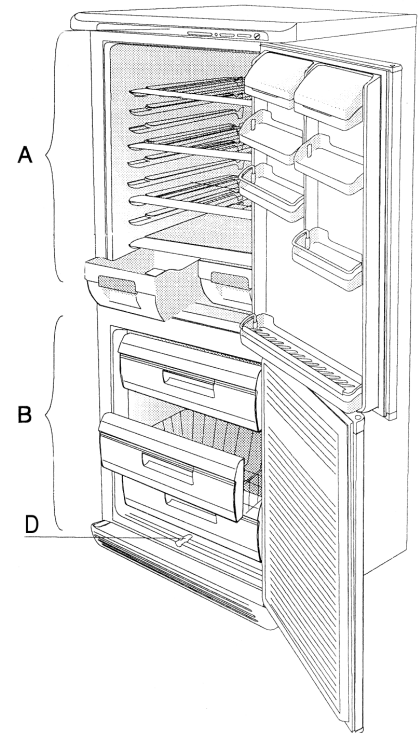

### 4.4 Shelves

each refrigerator comes complete with several shelves which can be set at different heights by placing them on the runners provided. Each shelf has a safety fitting to prevent it from being pulled completely out or accidentally removed. To remove it from the appliance, lift it at the back and extract it. Then change the position of the shelf or shelves as you require. For easy removal of all internal accessories, the door has to be opened completely.

### 4.5 Bottle shelf

Like ordinary shelves, the bottle shelf can also be set at different heights. It can be fitted into the refrigerator compartment in two different positions: horizontally or with the front part raised so that the bottles can be placed on a slant. To remove the bottle shelf, lift it at the back and pull it outward.

**Warning: if you wish to place bottles of above-average length on the bottle shelf, it must be set at a height which will not prevent the door from being closed properly.**

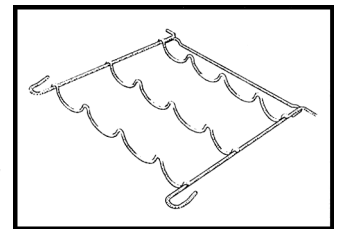

### 4.6 Refrigerator compartment defrosting water drain

The rear of the refrigerator compartment, underneath the refrigerating plate, has a channel and a hole for collecting the defrosting water. To ensure the refrigerator can function properly, take care never to block this hole. It is best to check and clean it fairly regularly using a piece of stiff wire.

### 4.7 Fruit and vegetable box

this container (there are 2 in the model FAB 32) is at the bottom of the refrigerator compartment, which is fitted with a glass shelf to cover fresh foods that require constant humidity for optimum storage.

### 4.8 Door shelves and containers

The inside of the door is fitted with special shelves and boxes to take eggs, butter, dairy products, tubes, preserves and other small packages. The bottom of the door has a shelf to take vertical bottles. To stop bottles from falling when the door is opened and closed, they must be secured with the special retainer rod supplied.



All door shelves and boxes can be removed for cleaning. To remove them from the door, tap them upward with your fist in the first on one side of the insertion zone and then on the other. Do not place excessively heavy bottles on the bottle shelf, and place bottles on the shelf gently when loading them (Fig.1). When removing bottles, do not pull them in a diagonal direction as this may over-strain the retainer rod (Fig.2).

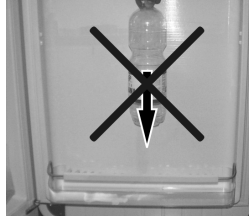

Fig. 1)

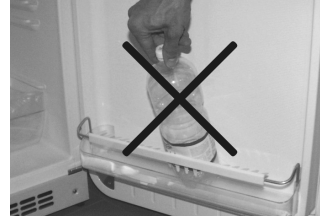

Fig. 2)

### **4.9 Cheese box**

A special cheese box with lid is supplied (depending on model). This box can be placed on any shelf as required.

### **4.10 Inside lighting**

When the refrigerator door is opened, the light comes on; it remains on until the door is completely closed again. The light comes on even if the refrigerator thermostat is set on "0" (stop), meaning that the refrigerator is switched off.

### **4.11 Fan (on some models only)**

The fan helps keep the temperature well distributed and reduces condensate on the shelves. It does not work when the refrigerator door is open. Turning on the fan is recommended when the ambient temperature and relative humidity are high.

To turn on the fan, press the symbol . To stop it, just set the switch on the symbol 0

*Electric energy consumption rises when the fan is operating*





## 5. ARRANGING FOODS INSIDE THE REFRIGERATOR COMPARTMENT

Arrange the foods on the various shelves, taking care that they have an airtight wrapping or cover. This precaution will:

- conserve foods' fragrance, moisture and freshness;
- prevent the cross-contamination of foods with different aromas and tastes;
- prevent the humidity level inside the refrigerator becoming too high because of the normal breathing of food (especially fresh fruit and vegetables). In some operating conditions (rise in ambient temperature and humidity, more frequent opening of the door) this might cause condensation to form on the shelves.

Use only containers approved for food storage. Always allow hot foods and drinks to cool to room temperature before placing them inside the refrigerator.

Never store explosive substances in the appliance and only store high-alcohol drinks firmly sealed and vertical.

## 6. SETTING AND SELECTING THE OPERATING TEMPERATURE

The knob in the top right-hand corner of the refrigerator is used to set the operating temperature both in the refrigerator and in the freezer (in case of the mod. **FAB32** it controls the operating temperature in the refrigerator section only).

When the knob is turned to **0** ("stop"), the appliance is switched off.

The operating settings are from 1 to 7.

There is no direct correspondence between the setting chosen and the temperature in the two sections of the appliance. Increasing the setting number reduces the temperature inside the appliance. Only use the highest settings (6-7) if absolutely necessary: with these settings, the temperatures inside the refrigerator compartment may be close to 0°C and electricity consumption will be higher. In normal operating conditions, a medium-low setting (2-3) is recommended. This will provide effective storage of the fresh foods in the refrigerator compartment and of the frozen foods in the freezer compartment.

On models fitted with cooling fan, a slightly higher temperature should be set when the fan is on, since the air currents reduce the temperature inside the refrigerator.

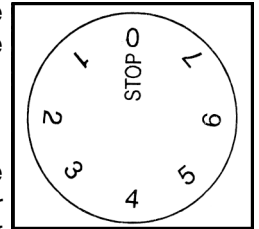

### **Important**

**Changes in weather conditions (temperature and humidity) and the frequency with which the doors of the two separate compartments are opened may affect the refrigerator's operating temperatures.**





## 7. SETTING AND SELECTING THE FREEZER COMPARTMENT OPERATING TEMPERATURE

### 7.1 Refrigerator without intensive cooling switch

24 hours before freezing a large amount of fresh foods turn the thermostat to a setting between 5 and 7. After the 24 hours have passed, insert the fresh foods and turn the thermostat knob to the setting of your choice (see "Setting the Temperature").



#### Important

**Changes in weather conditions (temperature and humidity) and the frequency with which the door is opened affect the refrigerator's operating temperatures.**

### 7.2 Refrigerator with intensive cooling switch

24 hours before freezing a large amount of fresh foods, turn on the switch on the thermostat regulator box. The function is enabled by pressing the switch so that the coloured "I" sign is visible. The switch is off when the "O" sign is visible. After turning on the intensive cooling function, turn the thermostat to a setting between 5 and 7. After the 24 hours have passed, insert the fresh foods, turn off the switch and turn the thermostat knob to the setting of your choice. This procedure should be used the first time the refrigerator is turned on, and whenever it is turned on after a period out of use, to lower the temperature in the freezer compartment more quickly. (See "Setting the Temperature")

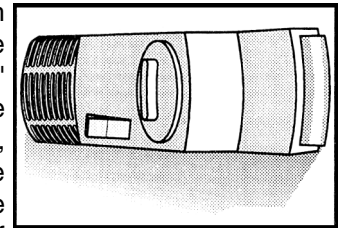

### 7.3 Refrigerator with intensive freezing switch and cooling system.

24 hours before freezing a large amount of fresh foods, turn on the switch on the thermostat regulator box. The function is enabled by putting the switch in the "❄️", position, and is turned off by putting it back on the symbol "0". After turning on the intensive cooling function, turn the thermostat to a setting between 5 and 7. After the 24 hours have passed, insert the fresh foods, turn off the switch and turn the thermostat knob to the setting of your choice. This procedure should be used the first time the refrigerator is turned on, and whenever it is turned on after a period out of use, to lower the temperature in the freezer compartment more quickly. (See "Setting the Temperature").

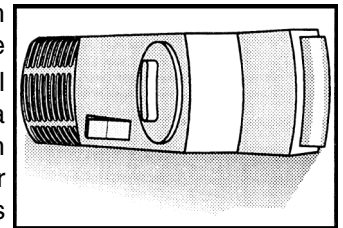

Cooling fan and intensive freezing cannot operate at the same time.

### 7.4 Refrigerator with rapid freezing function FAB32

The top of the appliance carries two switches and a selector knob for setting the freezing temperature.

#### 7.4.1 Control panel

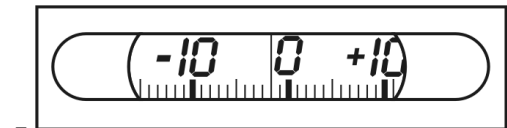
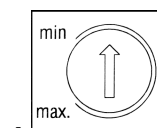
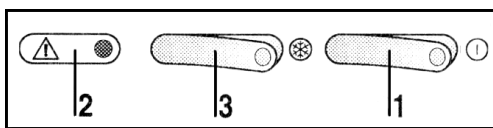

- 1 Freezer on/off switch;
- 2 Red warning light: indicates that the temperature inside the freezer is higher than the temperature set. Goes out when the set temperature is reached;
- 3 Rapid freezing switch;
- 4 Temperature regulator;
- 5 Freezer compartment temperature external thermometer.

To turn on the freezer press the switch 1. If the green light is on, the freezer is working. Then set the thermostat using the regulator provided (4). To reduce the temperature in the freezer compartment, adjust the setting from "min" to "max.". It is best to keep the regulator on a middle setting in normal operating conditions and only turn it to max for rapid freezing of the foods loaded. Settings close to the "min." level are recommended if there is only a small amount of food in the freezer compartment.



#### Important

**Changes in weather conditions (temperature and humidity) and the frequency with which the door is opened affect the refrigerator's operating temperatures.**



#### 7.4.2 Rapid freezing

To activate this function press switch 3 described in section “7. Setting and selecting the freezer compartment operating temperature”.

If the orange light is on, the function has been activated. When this function is set the refrigeration system operates continuously and allows rapid freezing of large amounts of fresh foods. Small amounts of fresh foods (up to about 2 kg) can be frozen even without activating the rapid freezing function.

To avoid wasting electricity, do not keep this function activated unless really necessary. The rapid freezing switch should be turned on the first time the freezer is turned on, and whenever it is turned on after a period out of use, to lower the temperature in the relative compartment more quickly. Do not place fresh or frozen foods inside until the red light (2) described in section “7. Setting and selecting the freezer compartment operating temperature”, which indicates that the set temperature has not been reached completely, has gone out.

#### **External thermometer**

Indicates the approximate temperature in the freezer compartment. It takes the thermometer a few hours to respond to changes in the thermostat knob setting because of the thermal inertia of the sensor.



#### **Important**

***The cooling temperature should be set so that the reading on the thermometer is -18°C or below. This is the best range for the proper storage of frozen and deep frozen foods.***



## 8. FREEZING FOODS

For proper storage and freezing, fruit and vegetables should be packed in portions of not more than 1 kg and meat and fish up to a max. of 2 kg. Small packages of food freeze more quickly, giving better conservation of their nutrients and flavour, even after thawing and preparation. Use only freezer bags, aluminium film, food-approved polyethylene film and freezer containers. Do not use paper bags, non food-approved cellophane bags, shopping bags or used freezer bags. Pack foods in airtight packs and try to expel all the air. If using bags, close the packs with the elastic bands or plastic-coated wire strips provided. Always cool hot foods to room temperature before placing them in the freezer and do not allow frozen foods to touch fresh foods for freezing. Always mark packs with the date of freezing, quantity and type of food and make sure that foods are fresh and in good condition. The max. amount of fresh foods which can be frozen in a 24-hour period is marked on the nameplate. Do not exceed the stated amount: this reduces the freezer's efficiency and its ability to preserve the frozen foods it already contains.

For models equipped with the intensive freezing switch: turn on the switch and turn the thermostat knob to the position 5-7 twenty-four hours before you freeze a large quantity of fresh foods. After 24 hours have gone by, put in the fresh foods and after another 24 hours have gone by, turn off the switch and turn the thermostat knob to the desired position. The switch is on when the marking "I", "❄" or the coloured marking is visible. It is off when the marking 0 on the switch is visible, or when the coloured marking is not visible.

### 8.1 Storing frozen foods

When purchasing frozen foods, always take care that the pack is not damaged, that the product is not past its sell-by date and that the thermometer of the freezer in which the products are displayed for sale does not show a temperature above -18°C. Also note the temperature advice, storage period and modes of consumption stated by the producer. Purchased foods should also be protected using suitable insulated containers during transportation to eliminate the risk of thawing. An increase in temperature might reduce their storage life and adversely affect their quality.

Do not purchase frozen foods which are carrying too much frost; they might already have been thawed.

FOOD	STORAGE PERIOD (IN MONTHS)											
	1	2	3	4	5	6	7	8	9	10	11	12
Vegetables								+	+	+		
Fruit										+	+	+
Bread - Confectionery			+									
Milk			+									
Ready-meals			+									
Meat: beef										+	+	+
veal								+	+	+		
pork				+	+	+						
poultry								+	+	+		
game						+	+	+				
minced meat				+								
Smoked sausage	+											
Fish: oily			+									
lean	+											
Offal		+										



***To prevent deterioration of frozen foods, do not exceed the permitted storage date, which depends on the type of food.***

### ***8.2 Thawing frozen foods***

Partially thawed foods should be eaten as soon as possible. Low temperatures preserve foods but they do not destroy the micro-organisms which are activated after thawing, which may cause the stored foods to deteriorate. If thawed foods smell and look normal, they can be cooked and if required re-frozen once they have cooled.

Depending on their type and intended use, frozen foods can be thawed correctly at room temperature, in the refrigerator, in an electric oven (conventional or fan), or in a microwave oven using the relevant function.

### ***8.3 Making ice-cubes***

Fill the tray provided 2/3 full of water or any other liquid you wish to freeze. Place it in the freezer compartment, making sure that its bottom is dry so that it will not stick to the shelf of the compartment. To detach the ice-cubes, twist the tray slightly or place it under running water for a few seconds.



## 9. MAINTENANCE AND CLEANING

### 9.1 Defrosting the refrigerator compartment

The refrigerator compartment has automatic defrosting. During normal operation of the refrigerator, frost forms on its back wall when the compressor is working and dissolves when it is not in operation. When the compressor is not working, the frost which has built up on the back wall melts and the water flows into the opening provided in the bottom of the body of the refrigerator. From here, it flows into the tray on the compressor, where it evaporates.



#### **Warning**

*the amount of ice which forms on the back wall may vary with changes in weather conditions (temperature and humidity), the frequency with which the door is opened, the appliance's operating temperatures and the amount of fresh foods stored inside (especially fruit and vegetables).*

### 9.2 Defrosting the freezer

The freezer compartment has to be defrosted manually. When the thickness of frost or ice on the shelves exceeds 2 cm, the freezer should be defrosted. A few hours before defrosting, use the knob provided to set the thermostat on 7 in order to further lower the temperature of the frozen foods (in case of mod. **FAB32** turn the freezer COOLING REGULATOR to the MAX setting). Then turn the knob to the 0 (stop) setting (in case of mod. **FAB32** turn the freezer off using the switch provided) and disconnect the plug from the electrical mains. Remove the frozen foods from the freezer compartment and protect them from thawing while cleaning. For the FAB32 model, fit the pipe provided into the groove in the bottom of the appliance. Place a container underneath the pipe to collect the defrosted water.

### 9.3 Cleaning the refrigerator

Before cleaning, disconnect the plug from the electrical mains. Clean the outside using only water and a gentle liquid detergent or an ordinary detergent for washable surfaces (such as a window-cleaning product). Never use products containing abrasives or substances which may attack the lacquered or painted parts, acids or chemical solvents. Use a sponge or a soft cloth.

Do not use steam cleaners to clean the inside; we recommend the use of specific disinfectants. Specific SMEG-brand products for cleaning steel are available from our Service Centres.

Remove the shelves and accessories, taking care not to apply excessive force when removing. Follow the instructions provided in the "Door Shelves and Containers" section carefully. Never wash removable plastic parts in the dishwasher; use only warm water and washing-up liquid or water and vinegar. Take care not to wet the electrical lighting components with water or detergents.

Clean the gaskets with warm water and then dry.

To allow the refrigerator to operate at full efficiency, periodically also clean the condenser on the rear with a brush or a vacuum cleaner.



Also make a periodic check on the tray above the compressor, and clean it if necessary.

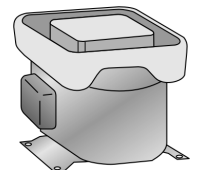

### 9.4 Switching off the refrigerator

If the refrigerator is to be out of use for some time, turn the thermostat knob to 0 (stop). For model FAB32, proceed as explained above to switch off the refrigerator section, and press the switch provided on the controls display to switch off the freezer. Then empty the compartments, disconnect the appliance from the electrical mains, and once it has defrosted dry any residual moisture which has collected. Leave the door ajar to prevent the humidity and trapped air from creating unpleasant smells.



### 9.5 Practical advice for saving energy

- Install the refrigerator in a cool, well ventilated place, protected against direct sunlight and well away from heat sources.
- Do not place hot foods in the refrigerator or freezer sections. Wait for foods and drinks to cool to room temperature before placing them on the shelves;
- Open the door(s) as infrequently and for as short a time as possible to prevent the compartments from warming up too much;
- Clean the condenser (rear of the refrigerator) periodically to prevent the appliance from losing efficiency;
- On models equipped with intensive cooling and rapid freezing, do not leave these functions activated for longer than absolutely necessary;
- If the refrigerator is to be out of use for a long period, it is best to empty it and switch it off;
- Thaw frozen foods in the body of the refrigerator in order to exploit the cold stored in the frozen foods, which will be transferred to the refrigerator if this procedure is used.

### 9.6 Operating noise

The refrigerator and freezer are cooled by means of a compression system. In order to maintain the preset temperature inside the refrigerator and freezer sections, the compressor comes into operation in response to the level of cooling required, and may operate continuously if necessary. When the compressor starts up a humming sound will be heard, tending to drop in volume after a few minutes. Another normal refrigerator operating noise is a gurgling due to the coolant flowing through the pipes in the circuit. This noise is perfectly normal and does not mean that the appliance is malfunctioning. If it is over-loud, there may be other causes. In this case, check that:

- the refrigerator is properly levelled on the floor and does not vibrate when the compressor is in operation: **adjust the feet provided as appropriate**;
- The drawers, shelves and door boxes are correctly fitted and securely in place: **fit correctly**;
- **Bottles and containers on the various shelves are stable and not touching**: the vibration due to operation of the compressor may generate some noise;
- Do not place **kitchen units or other appliances so that they are touching the refrigerator**.

### 9.7 Identifying and Dealing with Malfunctions

Your new refrigerator is designed and built to strict quality standards. This section is intended to enable you to identify the origin of any malfunctions which may occur before contacting the Smeg After-Sales Service.

### 9.8 Changing the inside light bulb

Before changing the bulb, make sure that the light has not stopped working simply because the part inside the lamp socket has become loose. In all cases, whether you wish to check that the socket is connected correctly or change the bulb, for safety reasons the plug must be removed from the power socket. Use your fingers to squeeze the cover (in the direction shown by the arrow 1) to remove it from its seat. Extract it (by pulling it in direction 2) and change the bulb (E14, max 15 W).

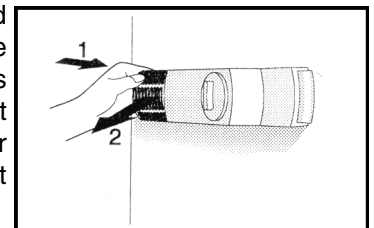



## 10. TROUBLESHOOTING GUIDE

PROBLEM	POSSIBLE CAUSE	PROBABLE SOLUTION
Noisy operation		- see "operating noise" section
The compressor starts up too often or operates continuously:	<ul style="list-style-type: none"> <li>- compressor and condenser cooling inadequate:</li> <li>- rise in outside temperature;</li> <li>- doors opened often or for long periods;</li> <li>- too much fresh food placed in the appliance</li> </ul>	<ul style="list-style-type: none"> <li>- check that the rear of the appliance is properly ventilated as explained in point "3.1 Choosing the site" and that the condenser is not over-dirty;</li> <li>- freeze less food at a time;</li> </ul>
The compressor does not start up:	<ul style="list-style-type: none"> <li>- temperature regulator on 0 (stop). In case of FAB 32, freezer switch turned off;</li> <li>- power supply lead not connected to the electrical mains;</li> <li>- mains socket not supplying electrical power.</li> </ul>	<ul style="list-style-type: none"> <li>- connect the lead to the power supply;</li> <li>- contact the electricity supplier</li> </ul>
Refrigerator section not cooled sufficiently	<ul style="list-style-type: none"> <li>- inside temperature setting thermostat set too low (1-2) (provides a higher temperature inside the appliance);</li> <li>- door opened often or for long periods;</li> <li>- door not closing properly</li> <li>- rise in outside temperature.</li> </ul>	<ul style="list-style-type: none"> <li>- Turn the regulator to an intermediate setting (4-5).</li> <li>- open the door less often and for as short a time as possible;</li> <li>- check that the foods are arranged on the shelves correctly and are not preventing the door from closing properly, and that the refrigerator is well levelled on the floor;</li> <li>- check that the gasket is sealing properly and is not damaged.</li> </ul>
Water in bottom of refrigerator compartment:	- "Condensation drain" opening blocked or frozen	- Clear the drain opening
Door hard to open just after closing:		- if you attempt to open the door again just after closing it (especially the freezer door), considerable strength is required. This is because of the vacuum caused by cooling of the warm air that has entered the appliance.



PROBLEM	POSSIBLE CAUSE	PROBABLE SOLUTION
<p>Temperature inside freezer not low enough to freeze foods properly</p>	<ul style="list-style-type: none"> <li>- inside temperature setting thermostat set too low;</li>   <li>- door opened often or for long periods;</li>   <li>- door not closing with an airtight seal;</li>   <li>- too much sugar in foods for freezing</li> </ul>	<ul style="list-style-type: none"> <li>- Turn the regulator to an intermediate setting (4-5). For mod. <b>FAB32</b> turn the regulator provide on the external display towards the "max" setting. If the red light is on, the temperature inside the freezer is higher than that set);</li> <li>- open the door less often and for as short a time as possible;</li> <li>- check that the foods are arranged on the shelves correctly, that the gasket is sealing properly and is not damaged, and that the refrigerator is well levelled on the floor;</li>   <li>- some foods can only be completely frozen at very low temperatures (ice-cream, concentrated fruit-juices)</li> </ul>
<p>Too much condensation forming in refrigerator section</p>	<ul style="list-style-type: none"> <li>- check that the door gaskets are providing an airtight seal on the refrigerator;</li>   <li>- door opened often or for long periods;</li>   <li>- too much fresh food (fruit and vegetables) placed on the shelves.</li> <li>- Foods not properly covered or stored in airtight containers</li> </ul>	<ul style="list-style-type: none"> <li>- In case of cracks, try to soften the gasket by pulling it with one hand and sliding your closed fingers along the inside</li> <li>- open the door less often and for shorter times, especially when the appliance is working in warm, humid conditions;</li> <li>- place less food inside the refrigerator section;</li>   <li>- Cover the containers and seal foods.</li> </ul>
<p>Temperature inside refrigerator section too cold - fresh foods are freezing:</p>	<ul style="list-style-type: none"> <li>- cooling temperature regulator device set too high (meaning lower temperature inside the appliance)</li> </ul>	<ul style="list-style-type: none"> <li>- Turn the regulator to a lower setting (1-2).</li>   <li>- cover foods using suitable bags and containers;</li> <li>- do not place fruit and vegetables inside when too wet</li> <li>- do not place foods inside touching the back of the refrigerator.</li> </ul>





PROBLEM	POSSIBLE CAUSE	PROBABLE SOLUTION
Too much ice forming on back wall of refrigerator section (layer of frost more than 1 cm thick):	<ul style="list-style-type: none"> <li>- Cooling temperature regulator device set too high (meaning lower temperature inside the appliance);</li> <li>- door opened often or for long periods;</li> </ul>	<ul style="list-style-type: none"> <li>- Turn the regulator to a lower setting (1-2) to increase the temperature inside the appliance slightly;</li> <li>- check that the gaskets are providing an airtight seal;</li> <li>- open the door less often and for shorter times;</li> <li>- rise in atmospheric temperature and humidity;</li> <li>- do not place hot food or drinks inside the refrigerator;</li> </ul>
Too much ice forming in freezer	<ul style="list-style-type: none"> <li>- inside temperature setting thermostat set on too low a temperature;</li> </ul>	<ul style="list-style-type: none"> <li>- Turn the regulator to a lower setting (1-2) to increase the temperature inside the appliance slightly;</li> <li>- check that the gaskets are providing an airtight seal: If they are cracked, try to soften the gasket by pulling it with one hand and sliding your closed fingers along the inside;</li> <li>- open the door less often and for shorter times;</li> <li>- rise in atmospheric temperature and humidity;</li> <li>- do not place hot food or drinks inside the freezer;</li> </ul>
Front of cabinet hot to the touch	-	<ul style="list-style-type: none"> <li>- the refrigerator is operating normally. Inside the cabinet there is a surface cooling system designed to restrict the formation of condensation in the area where the door gasket closes.</li> </ul>
Doors misaligned (except mod. FAB28)	-	<ul style="list-style-type: none"> <li>- check that the refrigerator is levelled properly, also adjusting the two rear feet if necessary (except mod. FA311X/XS and FAB310X/XS). Check whether changing the settings of the four feet improves the alignment.</li> </ul>



PROBLEM	POSSIBLE CAUSE	PROBABLE SOLUTION
Condensation forming on the gasket of the freezer compartment door (FAB28) or on the wall of the freezer compartment next to the door	- The gasket is not providing an airtight seal on the freezer compartment.	- Adjust the hinge if necessary: undo the two screws and raise or lower the hinge slightly as required. Then tighten the screws to fix it in place. If the condensation is on the top, raise the hinge; if it is on the bottom, lower it. - open the door less often and for shorter times, especially in warm, humid weather conditions;

**AFTER-SALES SERVICE – READING THE NAMEPLATE.**

IF THE PROBLEMS WITH THE PRODUCT YOU HAVE PURCHASED ARE NOT AMONGST THOSE DESCRIBED ABOVE AND IF YOU NEED MORE INFORMATION, PLEASE CONTACT THE AUTHORISED AFTER-SALES SERVICE. YOU WILL FIND THE ADDRESS AND TELEPHONE IN YOUR LOCAL TELEPHONE DIRECTORY UNDER **SMEG**.

TO SPEED UP THE SERVICE, PLEASE BE READY TO INFORM OUR CALL SERVICE OPERATORS OF THE MODEL OF THE PRODUCT YOU HAVE PURCHASED AND THE SERIAL NUMBER MARKED ON THE NAMEPLATE INSIDE THE BODY OF THE REFRIGERATOR. THANK YOU IN ADVANCE FOR YOUR ASSISTANCE.