

 smeg

INSTRUCTIONS FOR USE

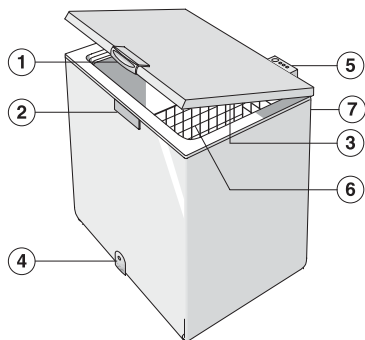

1. Lid handle.
2. Lock (if provided).
3. Seal.
4. Defrost water drain plug (depending on model).
5. Control panel.
6. Basket (depending on model).
7. Condenser (located at the rear).

Climatic Class	Amb. T. (°C)	Amb. T. (°F)
SN	From 10 to 32	From 50 to 90
N	From 16 to 32	From 61 to 90
ST	From 16 to 38	From 61 to 100
T	From 16 to 43	From 61 to 110

INSTALLATION

- Refer to chapter “Before using the appliance”.
- Unpack the appliance.
- Remove the 4 protection pieces inserted between lid and appliance.
- **Warning: two of the four protection pieces must be fitted in the seat of the condenser plastic supports, located at the rear of the product.**

This is necessary to ensure the correct distance from the wall.

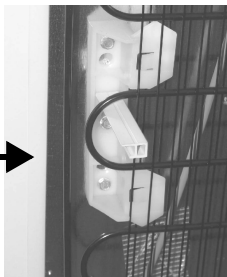

- Ensure that the defrosting water drainage plug (if provided) is correctly positioned (4).
- For best operation of the appliance and in order to avoid damage when the lid is opened, leave a space of at least 7 cm from the rear wall and 7 cm at the sides.
- Fit the accessories (if provided).

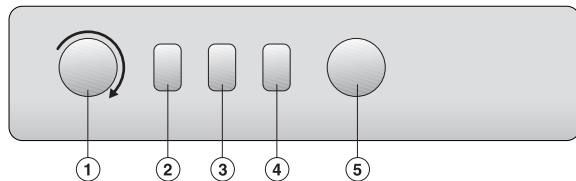

1. **Thermostat:** Temperature adjustment.
2. **Red LED (if provided):** indicates that the appliance temperature is not sufficiently low.
3. **Green LED (if provided):** indicates that the appliance is on.
4. **Yellow LED (if provided):** indicates that the fast freeze function is active.
5. **Fast freeze button (if provided):** press to activate the fast freeze function.

Switching on the appliance

- The appliance is factory set for optimum operation at a temperature of -18°C.
- Plug in the appliance.
- The green LED lights up (if provided).
- Also the red LED (if provided) will switch on because the temperature inside the appliance is not yet sufficiently low for food storage. The red LED will normally switch off within the first six hours after the appliance is switched on.
- **After connecting the appliance to the mains supply and when the optimal temperature has been reached (this phase takes about 1 hour during which the lid will not open), ensure that the fast freeze button is not pressed (the yellow LED, if provided, is off)**
- Place food inside the product only when the red LED (if provided) has switched off.
- Thanks to the efficient lid seal, the appliance lid will not re-open easily immediately after closing. Wait a few minutes before re-opening the lid of the appliance.

Temperature Adjustment

Use the thermostat to select the ideal storage temperature. To adjust the internal temperature, proceed as follows:

- Turn the thermostat knob to 1 for a storage temperature that is less cold.
- Turn the thermostat knob to 6 /  for a colder storage temperature.
- When the appliance is only partially full, choose a lower thermostat setting. For average loads, set the thermostat to “3 Eco/e” to optimize energy consumption.

INSTRUCTIONS FOR USE

BEFORE USING THE APPLIANCE

Your new appliance is designed exclusively for domestic use and for storing frozen food, freezing fresh food and making ice cubes.

Regulations require that the appliance is earthed. The manufacturer declines all liability for injury to persons or animals and for damage to property resulting from failure to observe the above procedures and reminders.

- After unpacking, make sure that the appliance is undamaged and that the lid closes perfectly tight. Any damage must be reported to your dealer within 24 hours after delivery of the appliance.

- Wait at least two hours before switching the appliance on in order to ensure the refrigerant circuit is fully efficient.
- Installation of the appliance and electrical connections must be carried out by a qualified electrician, in accordance with the manufacturer's instructions and local safety regulations.
- Clean the inside of the appliance before using it.
 - Before connecting the appliance to the mains supply, ensure that the voltage corresponds to that given on the rating plate located on the rear of the appliance.
 - Electrical connections must be made in accordance with local regulations.**

FREEZING FOOD

Preparation of fresh food for freezing

- Before freezing, wrap and seal fresh food in: aluminium foil, cling film, air and water-tight plastic bags, polyethylene containers with lids, provided they are suitable for freezing foods.
- Food must be fresh, mature and of prime quality in order to obtain high quality frozen food.
- Fresh vegetables and fruit should preferably be frozen as soon as they are picked to maintain the full original nutritional value, consistency, colour and flavour.
- Always leave hot food to cool before placing in the appliance.

Freezing fresh food

- Place foods to be frozen in direct contact with the walls of appliance:
 - foods to be frozen,
 - foods already frozen.
- Avoid placing foods to be frozen in direct contact with food already frozen.
- For best and fastest freezing, foods should be split into small portions; this will also be useful when the frozen items are to be used.

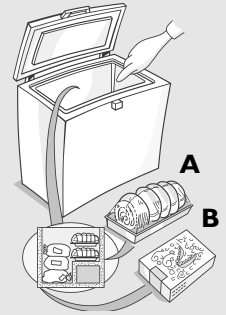

- At least 24 hours before storing fresh food in the appliance, press the fast freeze button. For appliances without this button, turn the thermostat to .
- Place the food to be frozen and keep the lid of the appliance closed for 24 hours. At the end of this period, switch off the fast freeze button (if provided).

FOOD STORAGE

Refer to the table on the appliance (if provided).









Classification of frozen foods

Put the frozen products into the appliance and classify them; The storage date should be indicated on the packs, to allow use within expiry dates.

Advice for storing frozen food

When purchasing frozen food products:

- Ensure that the packaging is not damaged (frozen food in damaged packaging may have deteriorated). If the package is swollen or has damp patches, it may not have been stored under optimal conditions and defrosting may have already begun.

MONTHS	FOOD		
1-3			
4-7			
8-12			

- When shopping, leave frozen food purchases until last and transport the products in a thermally insulated cool bag.
- Once at home, place the frozen foods immediately in the appliance.
- Avoid, or reduce temperature variations to the minimum. Respect the best-before date on the package.
- Always observe the storage information on the package.

Note:

Eat fully or partially defrosted foods immediately. Do not refreeze unless the food is cooked after it has thawed. Once cooked, the thawed food can be refrozen.

If there is a long power failure:

- Do not open the appliance lid except to place ice packs (if provided) over the frozen foods on the right and left of the appliance. This will slow down the rise in temperature.**

INSTRUCTIONS FOR USE

PRECAUTIONS AND GENERAL RECOMMENDATIONS

- **After installation, make sure that the appliance is not standing on the power supply cable.**
- Do not store glass containers with liquids in the appliance since they may burst.
- Do not eat ice cubes or ice lollies immediately after taking them out of the appliance since they may cause cold burns.
- Before servicing or cleaning the appliance, unplug it from the mains or disconnect the electrical power supply.
- Do not install the appliance in places exposed to direct sunlight or near heat sources in order to avoid increasing power consumption.
- Do not store or use gasoline or other flammable vapours and liquids in the vicinity of this or any other appliance. The fumes can create a fire hazard or explosion.
- Install the appliance in a perfectly horizontal position, on a floor strong enough to take its weight and in an area suitable for its size and use.
- Install the appliance in a dry and well-ventilated place. The appliance is set for operation at specific ambient temperature ranges, according to the climatic class indicated on the data plate located at the rear of the product. The appliance may not work properly if it is left for a long period at a temperature above or below the indicated range.
- If the appliance is left empty for short periods, it is preferable not to switch it off.
- Be careful not to damage the floors when you move the appliance (e.g. parquet flooring).
- Do not use mechanical devices or any means other than those recommended by the manufacturer to speed up the defrosting process.
- Do not use electrical appliances inside the product, unless such appliances are specifically recommended by the manufacturer.
- This appliance is not designed for use by young children or the infirm without supervision.
- This appliance is not intended for use by persons (including children) with reduced physical, sensory or mental capabilities, or lack of experience and knowledge, unless they have been given supervision or instruction concerning use of the appliance by a person responsible for their safety.
- The power cable may only be replaced by an authorized person.
- Do not use extension leads or adapters.
- Electrical disconnection must be possible either by unplugging the appliance or by means of a double-pole switch located upline from the socket.
- Ensure that the voltage indicated on the appliance data plate corresponds to the domestic supply voltage.
- Do not ingest the contents (non-toxic) of the ice packs (if provided).
- Restrict the number of times you open the lid.

DEFROSTING THE APPLIANCE

The appliance should be defrosted when the thickness of ice on the walls reaches 5-6 mm.

- Disconnect the appliance from the mains power supply.
- Remove the packs of food from the appliance and wrap them close together in newspaper and store in a very cool place or thermally insulated bag.
- Leave the appliance lid open.
- Remove the internal defrost water drain plug (depending on model).
- Remove the external defrost water drain plug (depending on model) and reposition it as shown in the figure.

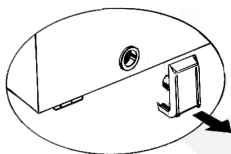

- Place a bowl beneath the drainage channel to collect the residual water. If available, use the divider.
- Speed up defrosting by using a spatula to detach the ice from the appliance walls.
- Remove the ice from the bottom of the appliance.
- **In order to avoid permanent damage to the appliance interior, do not use pointed or sharp metal instruments for removing the ice.**
- **Do not use abrasive products or heat up the interior artificially.**
- **Dry the interior of the appliance thoroughly.**
- On completion of the defrosting, refit the plug.

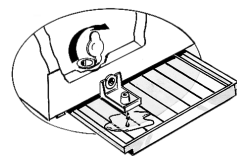

CARE AND MAINTENANCE

- Remove the ice from the upper edge (see the Troubleshooting Guide).
- Clean the inside after defrosting, using a sponge dampened with warm water and/or mild detergent.
- Clean the side motor cooling grille (depending on model).
- Remove dust from the condenser on the rear of the appliance.

Before carrying out maintenance, unplug the appliance.

Do not use abrasive products, scourers or stain-removers (e.g. acetone, trichloroethylene) to clean the appliance.

To obtain the best results from your appliance, carry out cleaning and maintenance at least once a year.

CHANGING THE LID LIGHT BULB (IF PROVIDED)

- Disconnect the appliance from the mains power supply.
- Remove the diffuser by following the sequence of steps shown in the figure.
- Unscrew the light bulb and replace it with an identical bulb of the same wattage and voltage.
- Refit the diffuser and plug in the appliance.

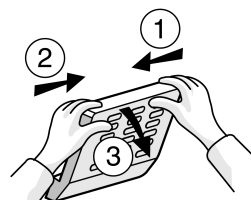

TROUBLESHOOTING GUIDE

1. The red LED (if provided) remains alight.

- Is there a power failure?
- Is a defrosting operation in progress?
- Is the appliance lid properly closed?
- Is the appliance placed near a heat source?
- Is the thermostat setting correct?
- Are the ventilation grille and condenser clean?

2. The appliance is too noisy.

- Is the appliance perfectly horizontal?
- Is the appliance in contact with other furniture or objects that may cause vibrations?
- Has the packaging been removed from under the appliance?

Note: Gurgling noises from the refrigerating circuit after the compressor cuts out are perfectly normal.

INSTRUCTIONS FOR USE

3. The green LED (if provided) is off and the appliance is not working.

- Is there a power failure?
- Is the plug properly inserted in the socket?
- Is the electric cable intact?

4. The green LED (if provided) is off and the appliance is working.

- The green LED is not working. Contact the After Sales Service for a replacement.

5. The compressor runs continuously.

- Have hot foods been put in the appliance?
- Has the appliance lid been left open for a long time?
- Is the appliance placed in a very warm room or near heat sources?
- Is the thermostat setting correct?
- Has the fast freeze function (depending on model) been pressed by mistake?

6. Too much ice on the upper edge.

- Are the defrost water drainage plugs correctly positioned?
- Is the appliance lid properly closed?
- Is the appliance lid seal damaged or deformed? (See chapter "Installation")
- Have the 4 protection pieces been removed? (See chapter "Installation")

7. Formation of condensate on the external walls of the appliance.

- It is normal for condensation to form under certain atmospheric conditions (humidity above 85%) or if the appliance is located in a damp or poorly ventilated room. The performance of the appliance is in no way affected.

8. The layer of ice on the internal walls of the appliance is not uniform.

- This phenomenon is quite normal.

SAFEGUARDING THE ENVIRONMENT

1. Packing

The packaging material is entirely recyclable, and marked with the recycling symbol. Follow local regulations for scrapping. Keep the packaging materials (plastic bags, polystyrene parts, etc.) out of reach of children, as they are potentially dangerous.

2. Scrapping

The appliance is manufactured using recyclable material . This appliance is marked according to the European directive 2002/96/EC on Waste Electrical and Electronic Equipment (WEEE).

By ensuring this product is disposed of correctly, you will help prevent potential negative consequences for the environment and human health, which could otherwise be caused by inappropriate waste handling of this product.

The symbol  on the product, or on the documents accompanying the product, indicates that this appliance may not be treated as household waste. Instead it shall be handed over to the applicable collection point for the recycling of electrical and electronic equipment.

Before scrapping, make the appliance unusable by cutting off the power cable and removing the doors and shelves so that children cannot easily climb inside the appliance.

Disposal must be carried out in accordance with local environmental regulations for waste disposal. Deliver the appliance immediately to an authorized dump; do not leave it unattended even for a few days, since it is potentially dangerous for children. For more detailed information about treatment, recovery and recycling of this product, please contact your local city office, your household waste disposal service or the shop where you purchased the product.

Information:

This appliance does not contain CFCs. The refrigerant circuit contains R134a (HFCs) or R600a (HCs), see the rating plate inside the appliance.

Appliances with Isobutane (R600a):

Isobutane is a natural gas with low environmental impact. Caution is required, however, since isobutane is flammable. Therefore, it is essential to ensure that refrigerant pipelines are not damaged.

This product contains Fluorinated Greenhouse Gases covered by the Kyoto Protocol, the refrigerant gas being in a hermetically sealed system. Refrigerant gas: R134a has a Global Warming Potential (GWP) 1300.

Declaration of conformity

- This appliance is designed to store food and is manufactured in conformity with European Directive 90/128/EEC, 02/72/EEC and Regulation (EC) No. 1935/2004 
- This appliance is designed, manufactured, and retailed in compliance with:
 - the safety objectives prescribed in the Low Voltage Directive 2006/95/CE (which replaced Directive 73/23/CEE as amended);
 - the protection requirements of the "EMC" Directive 89/336/EEC amended by Directive 93/68/EEC.
- The electrical safety of the appliance can only be guaranteed if the product is connected to an approved earth connection.

AFTER-SALES SERVICE

Before calling out an After-sales Service technician, make sure that:

1. the plug is properly inserted in the socket;
2. the mains electrical supply is present;
3. the meter box safety switch has not tripped;
4. the power supply voltage corresponds to that indicated on the appliance;
5. if the problem persists, contact the After-sales Service, tel. 199.135.135 * (in contact with your local area Technician).

Before calling the After-sales Service, be sure to have the following information ready:

- your full address and telephone number;
- the appliance model;
- the serial number ("S/N") of the appliance, indicated on the accompanying documentation and on the data plate on the rear of the unit;
- the nature of the fault.

* Maximum cost 14 cents/min (VAT included) without connection charge from landlines. Average cost 39 cents/min (VAT included) and maximum connection charge of 15 cents (VAT included) from mobile networks. For further details on mobile charges, contact your network operator.