



User Manual

UPS-1500-OL

1500 VA Stand Alone Online Battery Backup

UPS-2000-OL

2000 VA Stand Alone Online Battery Backup

UPS-3000-OL

3000 VA Stand Alone Online Battery Backup

SX-BDL-1500

1500 VA Stand Alone Online Battery Backup
with SX-1115 bundle

SX-BDL-2000

2000 VA Stand Alone Online Battery Backup
with SX-1120 bundle



Table of Contents

1.	EMC Statements – FCC Part 15	3
2.	Important Safety Instructions	4
3.	Introduction	6
4.	Product Description	6
	Double Conversion On-Line Technology.....	6
	Diagnostic Tests.....	7
5.	System Configuration	7
	LED Descriptions.....	9
	LCD Descriptions.....	10
	RS-232 Standard Interface.....	10
	SNMP Communications Option.....	11
	Remote Emergency Power Off (REPO) Port.....	11
6.	Determining the Power Requirements of Your Equipment	11
7.	Hardware Installation Guide	12
	Installation.....	13
	Standard Brackets.....	13
	19" Cabinet Ear Installation.....	13
	Vertical Installation Steps.....	14
	Wall-Mounted Installation Steps.....	14
	19" Rack Mount using 5 in 1 bracket.....	15
8.	Rackmount Installation Steps	16
	UPS Rail Installation Instructions for 19" Cabinet.....	16
9.	Initial Connection and Startup	19
10.	User's Operations	22
	Turning Off the UPS when connected to an AC Source.....	22
	Starting the UPS from a DC source (cold start).....	22
	Turning off the UPS when in DC Mode.....	22
	Self Test Operation.....	23
	Audible Alarm silence in DC Mode or Fault Mode.....	23
11.	Batteries	23
	Replacing the Battery.....	23
12.	Troubleshooting	25

13.	LCD Fault Codes	26
14.	Specifications	27
15.	Appendix A: Extended Battery Pack User Guide	30
	Estimated Run Time for UPS with Extended Battery Packs	30
	LED Description	32
	Extended Battery Pack Operation	32
	Extended Battery Pack Installation	34
	Extended Battery Pack Q&A	35
16.	Trademarks	36

Thank you for selecting this uninterruptible power supply (UPS). It provides you with protection for connected equipment. **Please read this manual** before installing the SurgeX SX-BDL-1500, SX-BDL-2000, UPS-1500-OL, UPS-2000-OL, UPS-3000-OL as it provides important information that should be followed during installation and maintenance of the UPS and batteries, allowing you to correctly set up your system for the maximum safety and performance. Included is information on customer support and service, if it is required. If you experience a problem with the UPS, please refer to the Troubleshooting section in this manual to correct the problem. If the problem is not corrected, please collect information so that the Technical Support personnel can more effectively assist you.

1. EMC Statements – FCC Part 155

Notice: Pursuant to section 15 of the FCC rules, this product has been tested and thereby complies to the conditions of a Class B (SX-BDL-1500, UPS-1500-OL) and Class A (SX-BDL-2000, UPS-2000-OL, UPS-3000-OL) digital device, which have been established for offering sufficient protection against dangerous interference for installation in a residential area. Installation and use of the equipment should comply with the instructions provided in order to avoid such interference due to the amount of radio frequency energy that is radiated and generated by the equipment. In spite of this, we cannot assure that a certain amount of interference may not occur in some installations. If, by turning on and off, it can be deduced that your radio or television reception is found to be influenced by harmful interference from the equipment, it is recommended to use one of the following preventive measures.

- Place the receiving antenna in a separate location or orientation.
- Ensure a greater distance is achieved between the receiver and the equipment.
- Ensure that your equipment is connected to an outlet on a separate circuit than the receiver.
- Contact a technician experienced with radio and TV or a dealer for further assistance.

ICES-003

This Class B Interference Causing Equipment meets all requirements of the Canadian Interference Causing Equipment Regulations ICES-003. Cet appareil numérique de la classe B respecte toutes les exigences du Règlement sur le matériel brouilleur du Canada.

Declaration of Conformity Request

Units labeled with a UL mark comply with the following standards and directives:

- UL 1778

CAUTION: A shielded-type power cord is required in order to meet FCC emission limits and to prevent interference to the nearby radio or TV reception. It is essential that only the supplied power cord be used. Use only shielded cables to connect I/O devices to this equipment.

Warning: Any changes or modifications not expressly approved by the manufacturer of this device could void the user's authority to operate the equipment.

2. Important Safety Instructions (SAVE THESE INSTRUCTIONS)

CAUTION! (UPS having Internal Batteries): Risk of electrical shock – Hazardous live parts inside this unit are energized from the battery supply even when the input AC power is disconnected.

CAUTION! (No User serviceable Parts): Risk of electrical shock, do not remove cover. No user serviceable parts inside. Refer servicing to qualified service personnel.

CAUTION! (Non-isolated Battery supply): Risk of electric shock, battery circuit is not isolated from AC input, hazardous voltage may exist between battery terminals and ground. Test before touching.

WARNING! (Fuses): To reduce the risk of fire, replace only with the same type and size of fuse.

WARNING! Unit intended for installation in a controlled environment.

CAUTION! Do not dispose of batteries in a fire, the battery may explode.

CAUTION! Do not open or mutilate the battery, released electrolyte is harmful to the skin and eyes.

CAUTION! A battery can present a risk of electric shock and high short circuit current. The following precaution should be observed when working on batteries:

- Remove watches, rings or other metal objects.
- Use tools with insulated handles.

To reduce the risk of electric shock, disconnect the UPS from the main supply before installing a computer interface signal cable. Reconnect the power cord only after signaling interconnections have been made. Servicing of batteries should be performed or supervised by personnel with knowledge of batteries and the required precautions. Keep unauthorized personnel away from batteries.

These UPS units are extremely heavy. Do not install the UPS in a rack or enclosure by its front two ears only. Adjustable rack rails are required for this type of installation.

The instructions contained within this safety manual are deemed important and should be closely followed at all times during installation and follow-up maintenance of the UPS and batteries.



CAUTION

The unit has a dangerous amount of voltage. If the UPS indicator is on, the unit's outlets may have a dangerous amount of voltage even when not plugged into the wall outlet because the battery may continue to supply power.

Care should be taken to undertake installation indoors, free from electrically-conductive particles which are under temperature and humidity control, in order to reduce the risk of electric shock.

It is best to disconnect the device using the power supply cord. Ensure that the equipment is placed in a position near the outlet where easily accessible.

Except for replacing the batteries, all servicing on this equipment must be carried out by qualified service personnel.

Before conducting any maintenance, repair, or shipment, first ensure that everything is turned off completely **and disconnected**.

For additional safety instructions, please use the Safety Manual as a reference.

Special Symbols

The following symbols used on the UPS warn you of precautions:



RISK OF ELECTRIC SHOCK – Please observe the warning that a risk of electrical shock is present



CAUTION: REFER TO OPERATOR'S MANUAL – Refer to the operator's manual for additional information, such as important operating and maintenance instructions



SAFE GROUNDING TERMINAL – Indicates primary safe ground



LOAD ON/OFF – Pressing the button turns on/off the output receptacles and the indicator light.



RJ45 RECEPTACLE – The receptacle provides network interface connections and telephone or telecommunications equipment should not be plugged into it.



Please do not discard of the UPS or the UPS batteries as the UPS may have valve-regulated lead-acid batteries. Please recycle batteries appropriately.

3. Introduction

The information provided in this manual covers single phase SX-BDL-1500, SX-BDL-2000, UPS-1500-OL, UPS-2000-OL, UPS-3000-OL uninterruptible power systems, their basic functions, operating procedures, options available and emergency situations. It also includes information on how to ship, store, handle, and install the equipment. Only detailed requirements of the UPS units are described herein, and installation must be carried out in accordance with this manual. Electrical installation must also carefully follow local legislation and regulations. Only qualified personnel should conduct these installations as failure to acknowledge electrical hazards could prove to be fatal.

4. Product Description

Many different kinds of sensitive electrical equipment can be protected by an Uninterruptible Power Supply (UPS) including computers, workstations, process control systems, telecommunications systems, sales terminals, other critical instrumentation, etc. The purpose of the UPS is to protect these systems from poor quality utility power, complete loss of power, or other associated problems.

Electrical interference exists in many forms, causing problems in AC power, from lightning, power company accidents and radio transmission motors, air conditioners, and vending machines. Protection of sensitive electrical equipment is vital to protect against power outages, low or high voltage conditions, slow voltage fluctuations, frequency variations, differential and common-mode noise, transients, etc.

To prevent power line problems from reaching critical systems causing damage to software, hardware, and equipment malfunctions, the UPS maintains constant voltage, isolating critical load output and cleaning the utility AC power.

Double Conversion On-Line Technology

A double conversion on-line technology UPS provides completely isolated, clean, uninterrupted single-phase power to your critical systems, while maintaining the batteries for their maximum potential. In the event that the power failure lasts longer than the UPS backup time, the UPS will shut down avoiding battery damage. When the input AC voltage returns, the UPS will automatically return online to recharge the batteries.

As shown in fig. 1 block diagram:

- An input filter reduces transients on the incoming utility.
- To maintain full battery charge, the AC input power is rectified and regulated in the rectifier feeding power to the battery converter and inverter.
- DC power is converted to AC in the inverter, passing it on to the load.
- Power is maintained from the battery during a power failure.
- The converter increases voltage appropriately for the inverter.

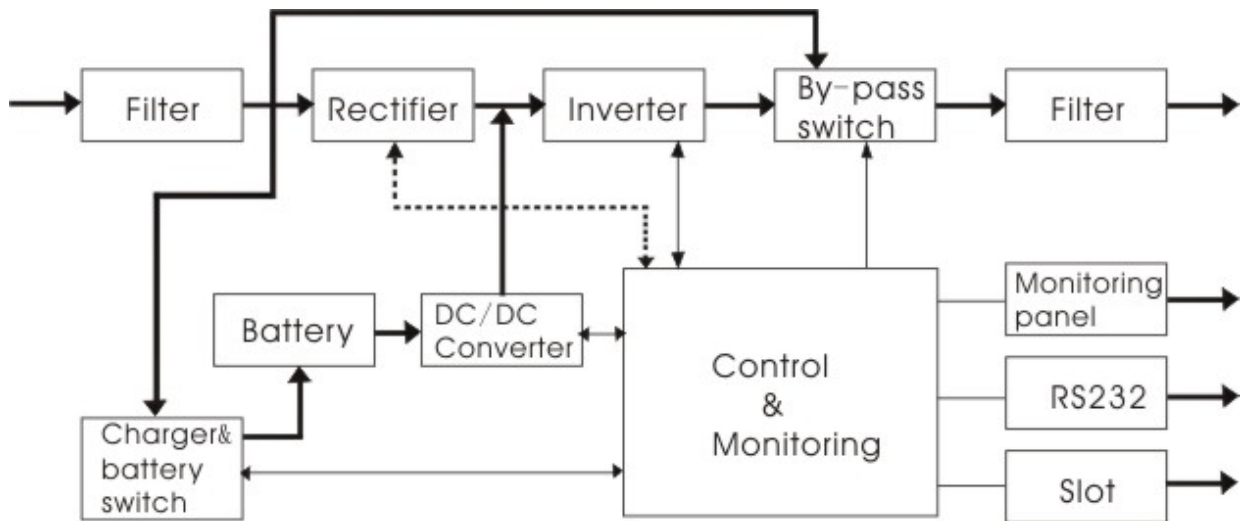

Figure 1 – Block Diagram

Diagnostic Tests

When the UPS is started, a diagnostic test is automatically executed, checking the electronics and batteries, reporting any problems on the LCD display. A diagnostic test can also be performed manually from the front panel at any time.

5. System Configuration

The UPS device and the internal batteries make up the system. Depending on the site and load requirements of the installation, certain additional options are available for the solution.

Planning a UPS system, the following should be taken into consideration:

- The total demand of the protected system shall dictate the output power rating (VA). Allow a margin for future expansion or calculation inaccuracies from measured power requirements.
- Backup time required will indicate the battery size needed. If the load is less than the UPS nominal power rating, then actual backup time is longer.
- The following options are available:
 - Extended Battery Packs
 - UPS-BPX-1500 for 1500
 - UPS-BPX-2000 for 2000/3000
 - Connectivity Options –SNMP/WEB card

See the Specification section of this manual for additional model information.

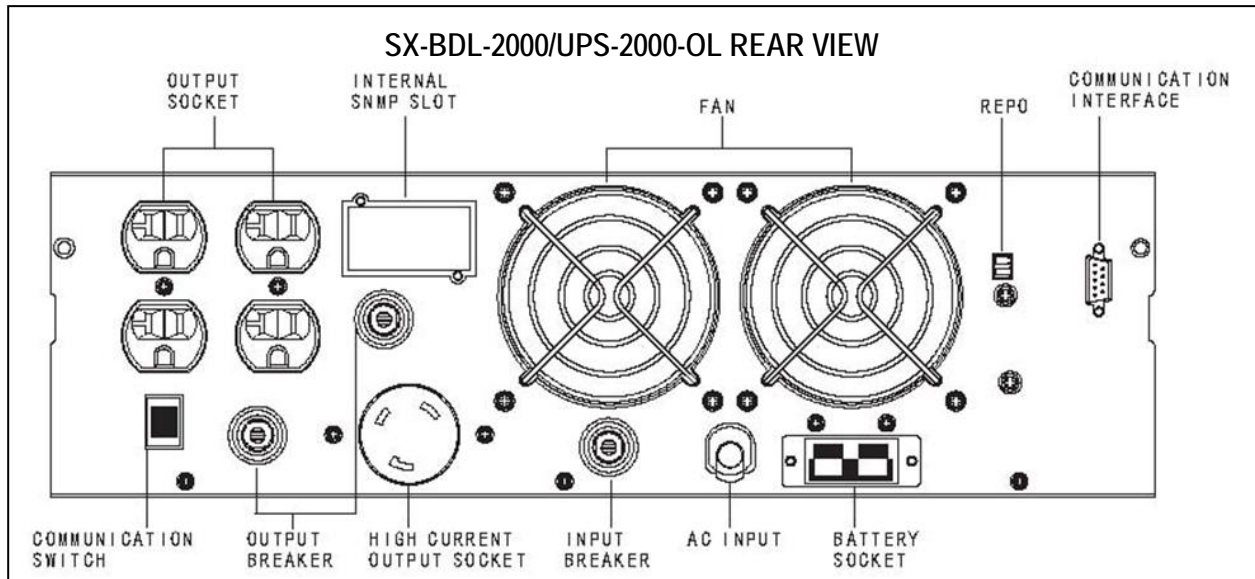
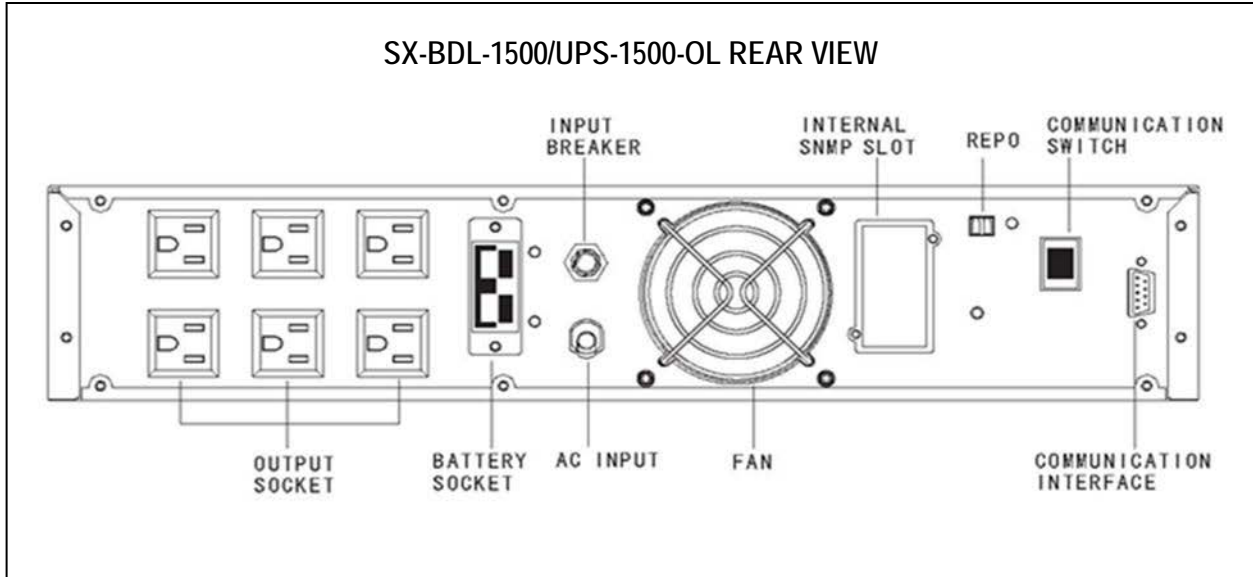

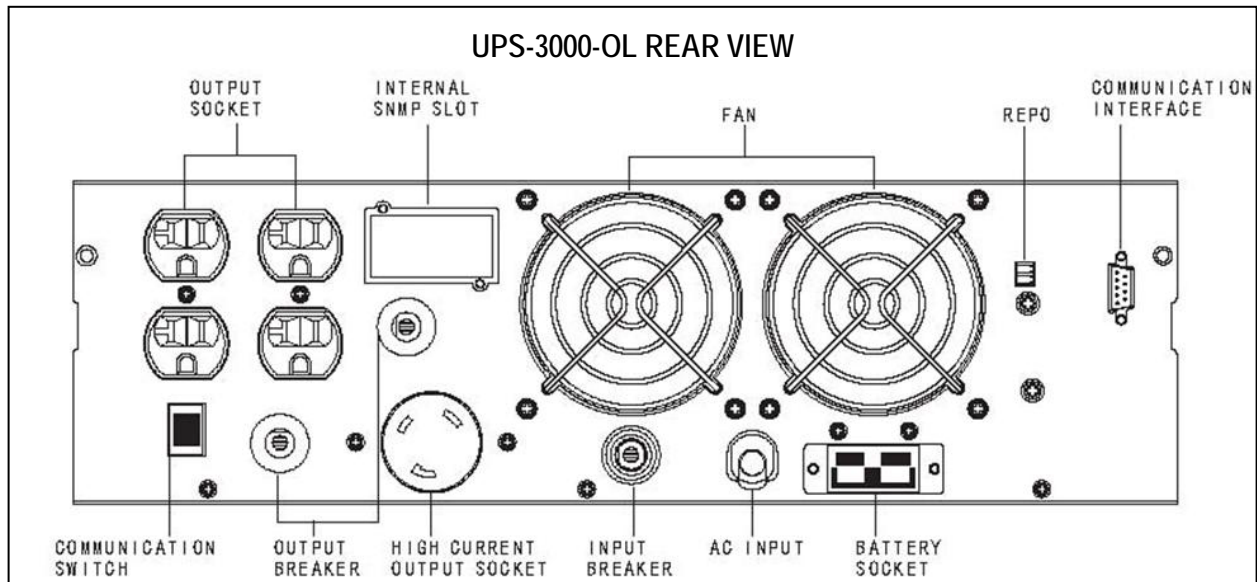

LED Description

The UPS has three LED's on the front control panel. These LED's allow the user to quickly understand if any action is needed.

Red LED

If this LED is illuminated it indicates a fault and the UPS will have no output. Faults that would indicate this alarm condition include:

- Overload
- Inverter fault
- BUS fault
- Over temperature fault

Yellow LED

If this LED is illuminated it indicates the user needs to take some action, and included:

- UPS in Bypass Mode
- Batteries Overcharged
- Charger fault
- Fan fault
- Batteries discharged to low voltage level

Green LED

If this LED is illuminated it indicates that everything is normal and the UPS is being powered by incoming AC utility or by the batteries

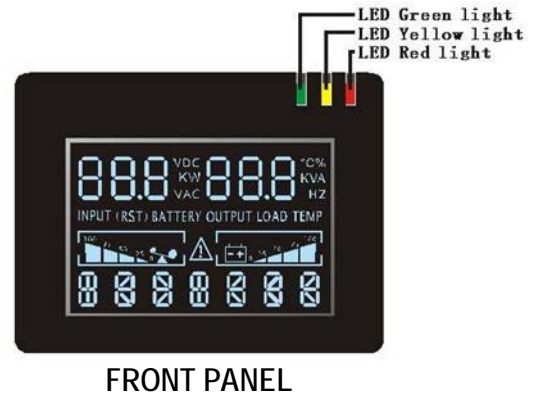

FRONT PANEL

LED Descriptions

There are four lines of information in the LCD display. Each line provides specific information related to the unit status and/or operation. Line information will be described from top to bottom with the top being line one.

Line One

Provides data in to numeric sections, with the data corresponding to the applicable category in line one and two

Line Two

Allows the user to identify which variable information is being displayed.

- Input
- Output
- Battery
- Load
- Temperature

Line Three

This is a graphics section with load graphics on the left and battery graphics on the right. The failure icon will appear in this section when a failure occurs.

Line Four

This indicates the status of the UPS.

- ON LINE = utility mode
- ON BATT = battery mode
- ON BPS = bypass mode
- UPS OFF = standby mode

RS-232 Standard Interface

The RS-232 interface uses a 9-pin female D-sub connector. Information provided includes data about utility, load and the UPS. The interface port pins and their functions are identified in the following table:



PIN #	FUNCTIONS
1,4,6,7,8	NOT USED
2	TRANSMIT
3	RECEIPT
5	GND
9	REMOTE WAKE UP

CAUTION: MAX RATED VALUES 12VDC

SNMP Communications Option

The UPS provides an intelligent slot for internal or external network card. This special intelligent network card can be compatible with popular software and hardware found on the web and in operating systems. It can support operating systems such as HP Open View, IBM Netview, SUN Netmanager, etc. This enables the UPS to provide instant UPS and power information over the network. Please contact your reseller for additional details.

NOTES: The UPS can be monitored through the RS232 interface or the SNMP card, but only one way at a time. The user can choose RS232 or SNMP communications through the communications switch on the rear panel of the UPS. RS232 is chosen if the switch is depressed to the RS232 position, and SNMP is chosen if the switch is depressed to the SNMP position. When there are two or more monitored pieces of equipment, the ground of each piece of equipment should be shared. The SNMP card is configured as DHCP by default IP setting.

Remote Emergency Power Off (REPO) Port

A customer supplied switch located remotely can be used to close the REPO connection and allows the UPS output receptacles to be switched off. Since the REPO shuts down the equipment immediately, orderly shutdown procedures are not followed by any power management software. The UPS will have to be manually restarted in order to regain power to the outlets on the UPS.

6. Determining the Power Requirements of your Equipment

- A. Make sure the total Volt-Amp (VA) requirements of your connected equipment does not exceed the maximum VA rating for the UPS. The maximum VA ratings are shown in the Specifications section of this document.
- B. Ensure that the equipment plugged into the battery-powered outlets does not exceed the UPS rated capacity. If UPS rated capacities are exceeded, an overload condition may occur and cause the UPS to shut down and trip the circuit breaker.
- C. If the power requirements of your equipment are listed in values other than Volt-Amps (VA), convert Watts (W) or Amps (A) into VA by doing the calculations below. Note: The equation below only calculates the maximum amount of VA that the equipment can use, not what is typically used by the equipment at any given time. Users should expect usage requirements to be approximately 60% of the value to estimate power requirements:

$$\text{Watts (W)} \times 1.43 = \text{ ______ VA } \text{ or } \text{ ______ Amps (A)} \times 120 = \text{ ______ VA }$$

Add the totals for all of the equipment and multiply this total by 0.65 to calculate actual power requirements.

NOTE: Many factors can affect the amount of power that your computer system will require. The total load that you will be placing on the battery-powered outlets should not exceed 85% of the UPS capacity.

7. Hardware Installation Guide

Inspect the UPS upon receipt. The packaging is recyclable; keep it for reuse or dispose of properly.

A. Safety Information

Information presented here is vital to all personnel. Please read all Safety information.

B. Storage and Transportation

Please handle the UPS and associated equipment with extreme caution since a high amount of energy is contained in the batteries. Always keep the unit in an upright position as marked on the packaging, and never drop the unit.

Please adhere to the following instructions if the UPS is not installed immediately:

- Store the equipment as is in its original packing and shipping carton.
- Do not store in temperatures outside the range of -15°C to $+25^{\circ}\text{C}$
- Ensure that the equipment is fully protected from wet or damp areas and from moist air.

In order to maintain the batteries, the UPS should be recharged every 6 months for at least 8 hours. If flammable substances such as gases or fumes are present, or if the room is airtight, a hazardous situation may exist in which no electrical equipment should be operated.

The instructions in this manual explain how to install the UPS safely. Not acknowledging such electrical hazards may be fatal – keep this manual for future reference.



WARNING! It is strongly recommended that the UPS cabinet not be opened as components have very high voltage and touching those components may be fatal. Only a qualified technician or authorized agent may service the unit.

The UPS unit's output receptacles carry live voltage even when not connected to an input voltage source. The UPS has its own internal energy source.

C. Environment

Ensure that all environmental concerns and requirements are met according to specifications listed in this document, otherwise the safety of installation personnel cannot be guaranteed, and the unit may malfunction.

Ensure that you remember the following when locating the UPS system and battery options:

- Avoid extremes of temperature and humidity. Maximum battery life can be attained with a recommended temperature range of $+15^{\circ}\text{C}$ to $+25^{\circ}\text{C}$.
- Provide protection for the equipment from moisture.
- Space and ventilation requirements must be met. Ensure there is 100mm behind and 50mm on the sides of the UPS for proper ventilation.
- Ensure that the front of the UPS remains clear for user operation.

D. Rack-Mount Accessories

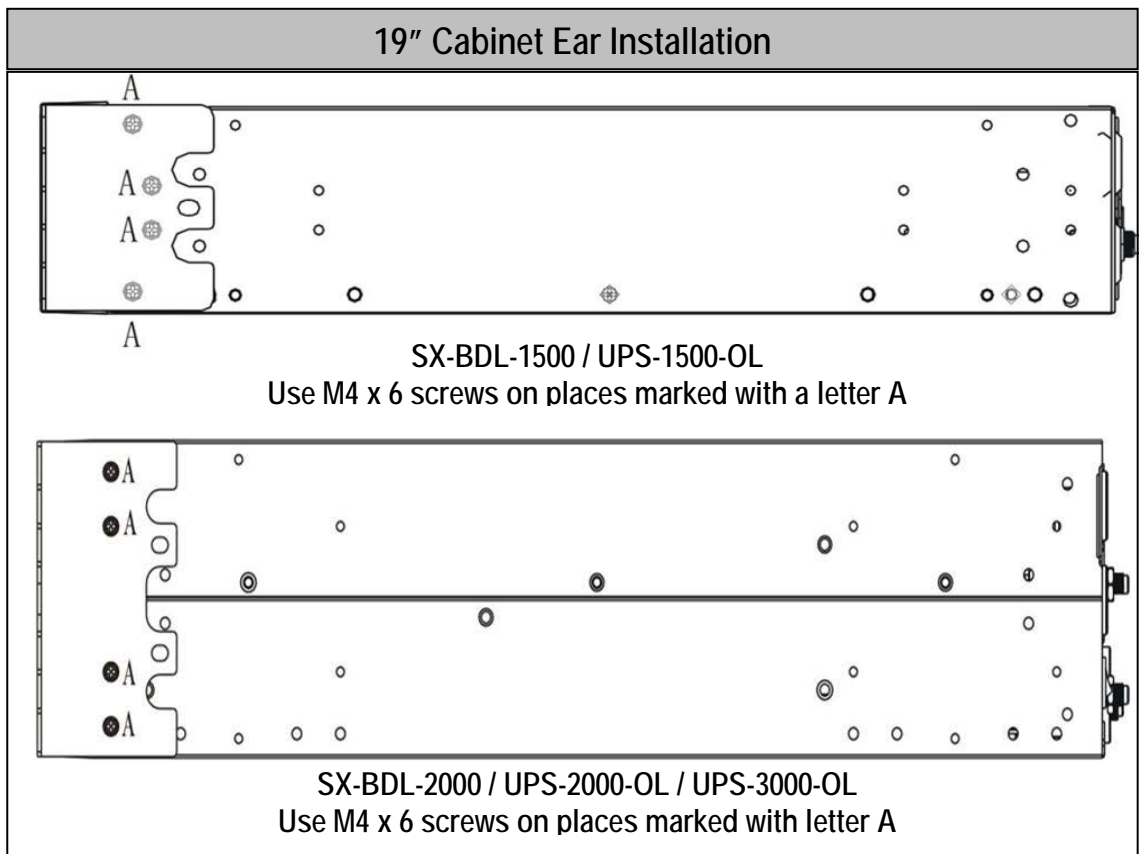
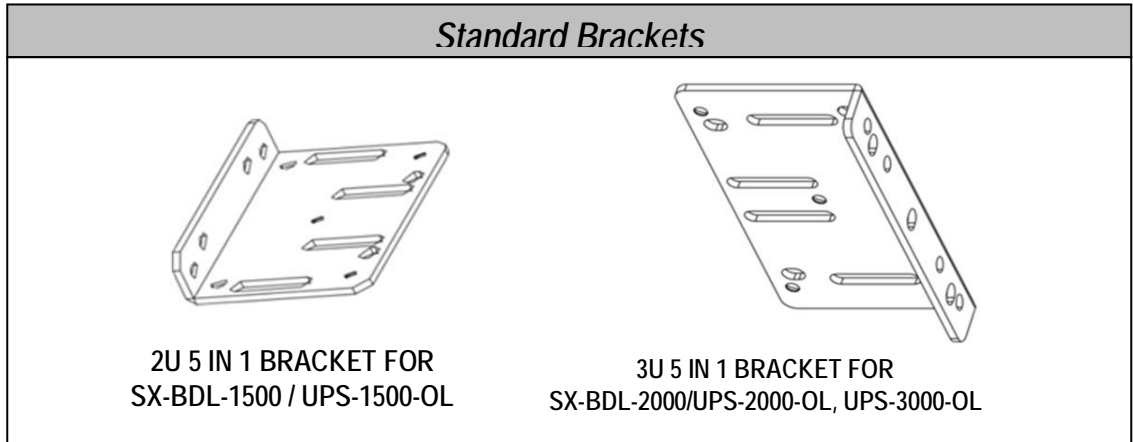

Vertical Installation Steps

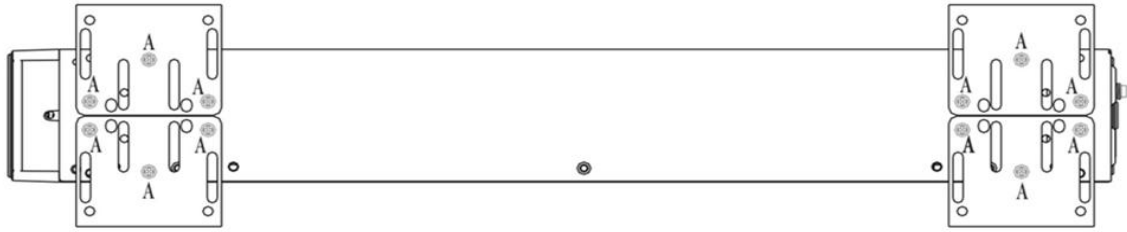

SX-BDL-1500 / UPS-1500-OL
Use M4 x 6 screws on places marked with letter A

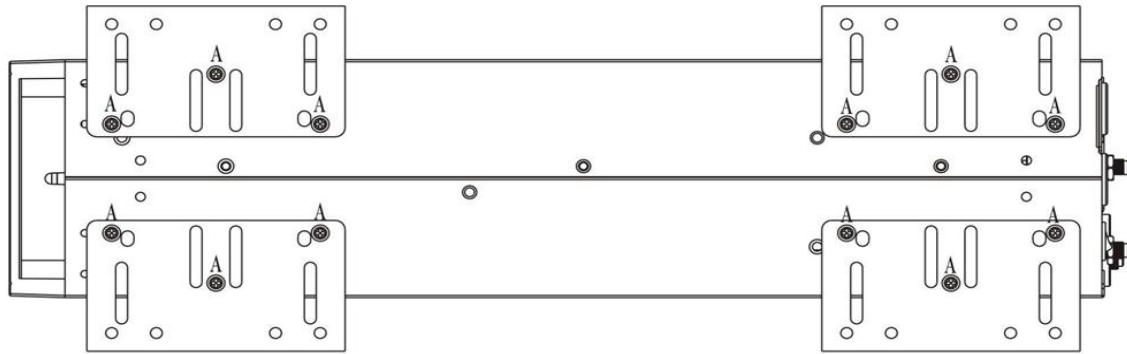

SX-BDL-2000 / UPS-2000-OL / UPS-3000-OL
Use M4 x 6 screws on places marked with letter A

Wall-Mounted Installation Steps



SX-BDL-1500 / UPS-1500-OL
Use M5 x 12 screws on places marked with letter B

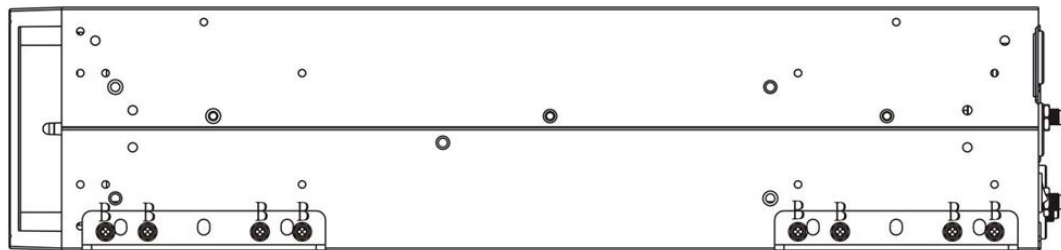

19" Rack Mount Using 5 in 1 Bracket

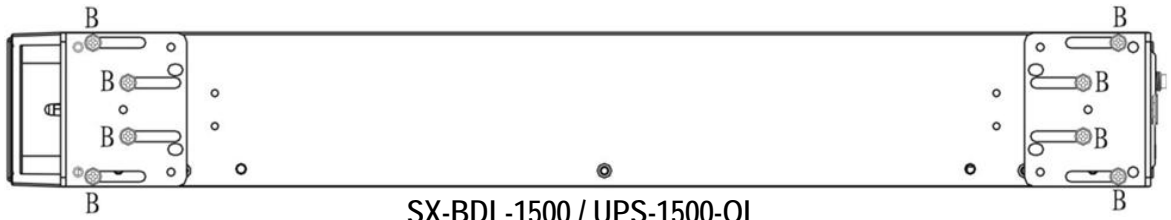

SX-BDL-1500 / UPS-1500-OL

Use M5 x 12 screws on places marked with letter B

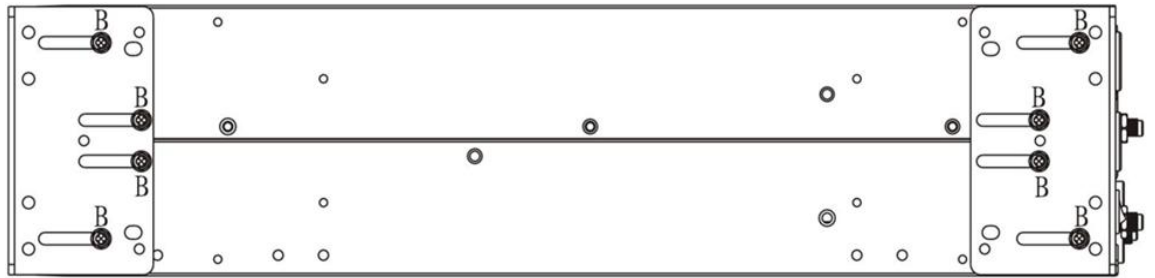

SX-BDL-2000 / UPS-2000-OL / UPS-3000-OL

Use M5 x 12 screws on places marked with letter B

8. Installation of Rack Mount and Accessories

A.

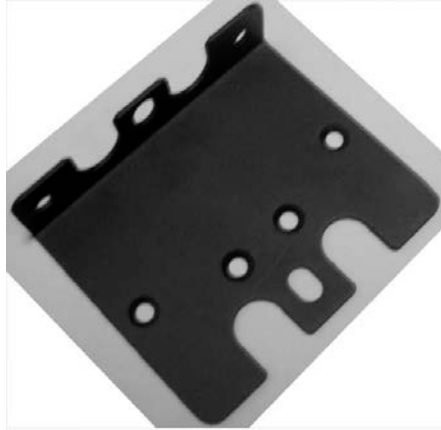

2U EAR FOR UPS OR BPX
MOUNTING IN CABINET

B.

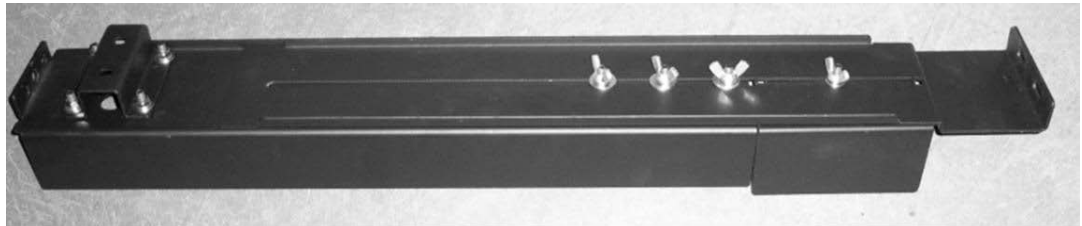

EXPANDABLE RAIL FOR UPS OR BPX MOUNTING IN CABINET

C.



MOVEABLE NUT FOR
MOUNTING RAIL KIT
IN CABINET

D.



UPS FRONT VIEW AFTER INSTALLING 2U EARS

E.



ASSEMBLE THE RAIL ONTO THE CABINET U-BAR WITH
SCREWS AT FRONT & BACK USING MOVABLE NUTS

F.



PUSH THE UPS OR BPX INTO THE CABINET VIA THE RAIL
FROM THE FRONT

G.



ATTACHE UPS OR BPX EAR ONTO CABINET U-BAR WITH
SCREWS ON BOTH LEFT & RIGHT SIDES

NOTE: Any external Battery Packs must be installed next to or under the UPS. Please refer to Appendix A: Battery Pack User Guide for more information when installing these.

9. Initial Connection and Startup

Ensure that the UPS and optional battery packs are mounted correctly, and the UPS is disconnected from input power before proceeding.

A. Connections Installation

1. Connect external battery packs (option)

CAUTION: CONNECT ONLY BATTERY PACKS PROVIDING THE SAME DC VOLTAGE AS THE UPS – PLEASE DOUBLE CHECK LABELING ON THE UPS AND BATTERY PACKS TO ASSURE PROPER VOLTAGES ARE CONNECTED. CONNECTING THE INCORRECT BATTERY PACK TO THE UPS MAY RESULT IN DAMAGE TO THE UPS AND/OR BATTERY PACK THAT WILL VOID THE WARRANTY.

- Ensure that the UPS is disconnected from AC input and is off while connecting the External Battery Packs. Ensure all battery breakers are in the “OFF” position.
 - Remove the EBP covers on the UPS and EBP. Connect the battery cable that comes with the External Battery Pack between the External Battery Pack to the UPS.
 - Secure the DC battery cable to the rear of the UPS, and the rear of the EBP by using M3 x 8 screws provided (2 each per connector end).
 - Connect the 5-15P from the EBP to an input AC utility source per specifications.
 - Connect a second battery pack to the first EBP in the same fashion if more than one is to be installed.
 - Refer to Appendix A: Battery Pack User Manual for more details
- #### 2. Connect SNMP card (option)
- Remove the two screws securing the SNMP cover plate on the rear of the UPS, and slide the SNMP NetAgentII card into the slot. Secure the card into the slot with the two screws previously removed.
- #### 3. Close the battery breakers on the Optional battery packs if installed.
- #### 4. Connect Devices to UPS
- A. Plug the equipment/devices that require battery back-up into the back of the UPS. Avoid using an extension cord.
- Be sure to plug your core equipment (e.g. computer, monitor, critical data storage device, etc.) into the Battery Power supplied outlets.
 - Plug your peripheral equipment (e.g. printer, scanner, fax, audio device) to the Bypass outlet(s).
 - Do not plug a laser printer into the UPS output outlets, as its power demand is much higher than typical peripherals and may cause the circuit breaker to trip. It is suggested that laser printers and other heavy loads be connected to the Bypass outlets.

5. **Connect to Utility Power**

For UPS-1500-OL, UPS-2000-OL, UPS-3000-OL Models only:

(For SX-BDL-1500 and SX-BDL-2000 connection installation, skip to instructions below)

- A. Plug the UPS into a 3-wire grounded receptacle of proper size per UPS specifications. Make sure the receptacle is protected by the proper size fuse or circuit breaker, and is not located on the same circuit with equipment requiring higher amounts of power (e.g. refrigerator, air conditioner, copier). Avoid using an extension cord to connect the UPS to the input power receptacle.
- **NOTE:** Size of Branch Circuit Over-current Protection – CAUTION – to reduce the risk of fire, connect only to a circuit provided with 30 amperes maximum branch circuit over-current protection in accordance with National Electric Code, ANSI/NFPA 70.

For SX-BDL-1500 and SX-BDL-2000 Models only:

(For UPS-1500-OL, UPS-2000-OL, and UPS-3000 connection installation instructions, refer to instructions above)

- A. **Connect UPS to SX-1115:** Plug the UPS power cord into the SX-1115 (into the receptacle on the back of the SX-1115). Avoid using an extension cord.
- B. **Then plug the SX-1115 into a 3-wire grounded receptacle of proper size.** Make sure the receptacle is protected by the proper size fuse or circuit breaker, and is not located on the same circuit with equipment requiring higher amounts of power (e.g. refrigerator, air conditioner, copier). Avoid using an extension cord to connect the SX-1115 to the input power receptacle.
- C. **NOTE:** Size of Branch Circuit Over-current Protection – CAUTION – to reduce the risk of fire, connect only to a circuit provided with 30 amperes maximum branch circuit over-current protection in accordance with National Electric Code, ANSI/NFPA 70.

6. **Connect Telephone or Data Device**

- A. If you wish to protect a fax, modem or other telephone or data networking device, plug the cable from the wall into the "IN" jack. Connect the cable provided with the UPS from the "OUT" jack to the fax, modem, or other networking device. To protect a 10Base-T (UTP) network interface, obtain and use a UTP cable to connect the "OUT" jack to your computer.

7. **Charge Batteries:** Once the UPS has been connected to an AC power source the internal charger will start charging the UPS batteries, at this point the yellow LED is illuminated, and the LCD displays "UPS OFF". In this state the output voltage is zero, which means UPS has no output. Please realize that although you may start using the UPS immediately, maximum back-up time will still not be available, so it is recommended to charge the batteries for a minimum of 6 hours before use.

B. Startup Installation

1. Start and configure the UPS



On/Off Button

Function Button

Inquiry Button

- Press and hold the ON/OFF button for more than 3 seconds to turn on the UPS. The UPS should now start its inspection of the internal functions, main synchronization, and inverter startup. Then power should start to be supplied via the outlets. Once turned on, the UPS will perform a self-test function, when the yellow LED turns to green, LCD displays "on line", and means UPS is working in utility mode.
- ### 2. Configure the local monitoring software if desired.
- Insert the UPSilon 2000 CD (included with UPS packaging) into the CD ROM of the local computer.
 - Select "Install program" from the Autorun menu and choose for the correct operating system.
 - Follow the setup instructions. Enter the product key when prompted. The software key is found on the CD cover. Click finish when prompted.
 - The UPSILON icon will appear in the system tray of the desktop near the system clock. Double click this icon to enlarge the program window.
 - Connect the RS232 cable (included in the UPS packaging) to the Computer and UPS. Communication should start momentarily. If it does not, click on Settings up on the UPSilon toolbar, then select a different Comport until communication is established.
 - Click on "Manual" in the UPSILON toolbar for further software configuration.

NOTE: PLEASE VERIFY AUTOMATIC SHUTDOWN TIME PARAMETERS IN THE SETTINGS SECTION FOR YOUR SPECIFIC INSTALLATION.

3. Configure the optional NetAgentII SNMP card if installed.

- Insert the NetAgent Utility CD (included with SNMP packaging) into a PC and download the user manual
- Install Netility from the AutoRun menu
- Connect a network cable from the PC to the SNMP card.
- Run Netility program and it will auto-search and list available NetAgents (SNMP card)
- Highlight and click "Configure" to change the network settings on the NetAgent discovered.
- Disconnect the cable to the PC and connect the SNMP card to your network.
- Access the SNMP card via the network and make configuration changes using the manual downloaded previously.

NOTE: PLEASE VERIFY AUTOMATIC SHUTDOWN TIME PARAMETERS IN THE SETTINGS SECTION FOR YOUR SPECIFIC INSTALLATION.

4. After charging is complete, connect the loads to the UPS while monitoring the load levels via the UPS LCD or via the software.
 - Do not connect any devices that have the possibility of overloading the UPS.

Refer to the Troubleshooting section and/or Technical Support with any problems during setup.

10. User's Operations

The only operations that users are permitted to do are:

- Turning the UPS unit ON or OFF
- Operating the user interfaces
- Connecting data interface cables
- Changing the batteries

All such operations are to be performed exactly as instructed in this manual. The greatest care possible must be taken for any of these operations, and any change thereof may prove very hazardous to the operator.

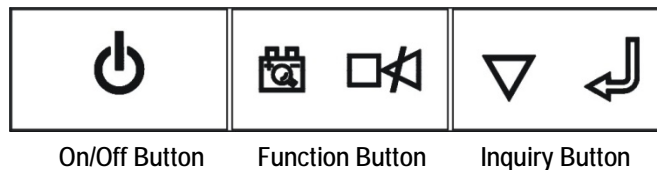

Turning Off the UPS when connected to an AC source

- Press and hold the ON/OFF button for more than 3 seconds to turn off the UPS. This means the internal inverter has been deactivated.
- The unit will run a self test prior to the deactivation of the inverter.
- The green LED will be off and the yellow LED will be on. The LCD display will indicate "On BPS", which means the UPS is providing no output.

Starting the UPS from a DC source (cold start)

- Assure that the UPS has fully charged batteries and the internal battery pack is connected.
- Assure that there is no AC input power source and/or the unit is not plugged into an outlet.
- Press and hold the ON/OFF button for three seconds.
- Once turned on, the UPS will perform a self-test function, when the yellow LED turns to green, LCD displays "On Batt" – the UPS is now functioning in DC mode.

Turning Off the UPS when in DC Mode

- Press and hold the ON/OFF button for more than 3 seconds to turn off the UPS. This means the internal inverter has been deactivated.
- During the shutdown period, the UPS will run a self test. Once the self-test has been completed, assuming there is still no AC input, the LCD will no longer display information. This indicates the UPS has no output.

Self Test Operation

Please refer to the three operating buttons on the front panel of the UPS.

- Confirm the UPS is in "Utility Mode".
- Press and hold the "Function" button for a minimum of two seconds.

The self-test will last for 10 seconds, during this time the LED's will be lit in a sequential, repeating fashion

Audible Alarm silence in DC Mode or Fault Mode

- When the UPS is in DC Mode, the audible alarm will sound every four (4) seconds. Press and hold the "Function" Button for a minimum of two (2) seconds to disable the audible alarm.
- When the UPS is in Fault Mode, the audible alarm will continuously sound. Press and hold the "Function" Button for a minimum of two (2) seconds to disable the audible alarm.

11. Batteries

REPLACING THE BATTERY (Qualified Service Personnel Only)

CAUTION! Read and follow the IMPORTANT SAFETY INSTRUCTIONS before servicing the battery. Service the battery under the supervision of Qualified Service Personnel knowledgeable of batteries and their precautions.

CAUTION! Use only the specified type of battery. See your dealer for replacement batteries.

CAUTION! The battery may present risk of electrical shock. Do not dispose of batteries in a fire as it may explode. Follow all local ordinances regarding proper disposal of batteries.

CAUTION! Do not open or mutilate the batteries. Released electrolyte is harmful to skin and eyes and may be toxic.

CAUTION! Although the battery system voltage is only 12VDC and 24VDC, the battery can present a high risk of short circuit current and electrical shock. The short circuit current capability of the battery is sufficient to burn wire or tools very rapidly, producing molten metal. Observe these precautions when replacing the battery:

- A. Remove all watches, rings or other metal objects.
- B. Only use tools with insulated handles.
- C. Do not lay tools or metal parts on top of battery or any terminals.
- D. Wear protective eye wear (goggles), rubber gloves, and boots.
- E. Disconnect the charging source before connecting or disconnecting the battery terminals.
- F. Determine if the battery is inadvertently grounded. If inadvertently grounded, remove the source of the ground. Contact with a grounded battery can result in electrical shock! The likelihood of such shock will be reduced if such grounds are removed during installation and maintenance (applicable to a UPS and a remote battery supply not having a grounded circuit).

Slide the plastic cover to the right



Remove the M5 x 10 screws on the right side



Remove plastic front cover

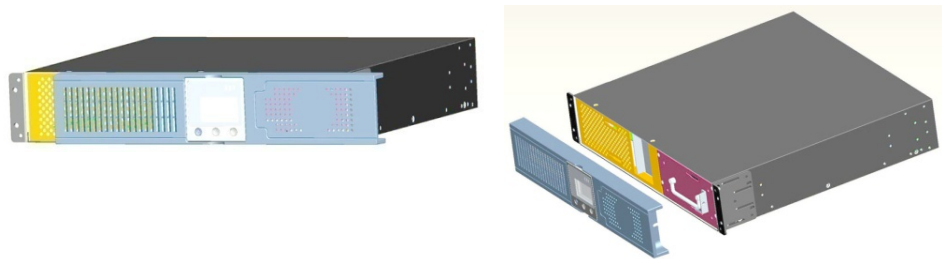

Locate the battery tray on the right front side of the UPS

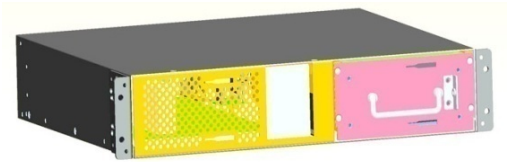

Remove (4) M4x6 screws marked with letter A.



Remove the battery tray from the UPS.

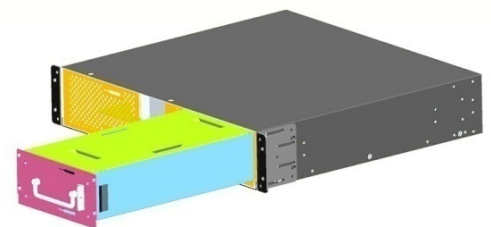

12. Troubleshooting

Issue	Audible Alarm	Alarm Description	What You Should Do
The "Input" letters in the second row of the LCD are flashing	Two Beeps per second at startup for 8 total seconds	The Input Voltage or frequency may be beyond the normal acceptable range.	Verify that utility voltage and frequency is within acceptable range. If so, contact support.
The "Input" letters in the second row of the LCD are flashing	One beep per 2 minutes	Possible mis-wiring AC line and neutral line	Check wiring of input to UPS (reversed wiring, etc) Rewire, if necessary
Battery Indicator Flashing	One beep per second	Batteries are undercharged, disconnected or need to be replaced.	Check UPS batteries. If necessary reconnect batteries, wait 12 hours to charge or replace defective batteries
Utility Normal-UPS has no AC input	N/A	Possibility that circuit breaker on UPS has tripped	Reset circuit breaker
Insufficient battery run-time	Once every 4 seconds in DC mode	"On batt" displayed on LCD	<ol style="list-style-type: none"> 1. If batteries are undercharged let UPS charge batteries at least 12 hours 2. After charging, if runtime is still insufficient, replace with new batteries 3. Reduce output load to lengthen runtime
UPS will not start after pressing the "On/Off" button	N/A	<ol style="list-style-type: none"> 1. Insufficient time for button depression 2. UPS has no battery connected 3. Battery voltage is too low to power the load 4. Fault has occurred inside the UPS 	<ol style="list-style-type: none"> 1. Depress the "On/Off" button for at least three seconds 2. Make sure the batteries are connected and the connector on the battery cartridge is "mated" correctly 3. Plug the UPS in, remove all loads, and allow to charge for 12 hours 4. Contact dealer for service details
Major fault detection by the UPS	Constant beep	Type of fault and fault code displayed on LCD.	Review abnormal process information table listed below in this manual and take appropriate action, If problem does not resolve contact supplier for service and provide error code(s)

13. LCD Fault Codes

	BYP MODE	LINE MODE	BAT MODE	BAT TEST MODE
BUS FAULT	62	05、 25	01、 21	40、 41
INV FAULT	61、 63	04	24	42
OVERHEAT	33	06	08	43
OP SHORT	/	16	02	44
OVERLOAD	/	03	09	45
FAN FAULT	36	28	38	46
CHARGE FAULT	07	07	/	/
BAT OVER	11	11	11	11

14. Specifications

	120V MODEL	SX-BDL-1500 UPS-1500-OL	SX-BDL-2000 UPS-2000-OL	UPS-3000-OL
INPUT	Voltage	120 VAC (80 - 138V at 100% load) 60-138V at 40% load		
	Capacity VA (W)	1500 VA (1050 W)	2000 VA (1400 W)	3000 VA (2100 W)
	Frequency	60 Hz		
	Power Factor	≥ 0.97		
	Topology	True on-line, Double conversion, Input PF correction		
OUTPUT	Voltage	120 VAC		
	Frequency	60 Hz		
	THD (full load)	Linear ≤ 5%; non-Linear ≤ 10%		
	Wave Form	Sine wave, zero transfer time		
	Load Power Factor	0.7		
	Efficiency AC/DC/AC	≥90%		
	Auto Restart	Yes		
	Start on Battery	Yes		
	Rated Current	12.5 A	16.6 A	25 A
	Overload Capacity	110-150% for 30 sec, ≥ 150% for 200 msec		
	Crest Factor	3:1 at full load		
BATTERY	Battery Type (UPS)	(4) 12V 7.2 AH / 48V	(8) 12V 7.2AH / 96V	
	Backup Time	7-11 min (internal batteries) to 18 hours using External Battery Packs (EBP)		
	Extended Battery Packs	UPS-BPX 1500	UPS-BPX 2000/3000	
	Battery Type (EBP)	2 strings of (4) 12V 7.2 AH / 48V	2 strings of (8) 12V 7.2 AH / 96V	
	Recharge Time	< 8 hours to 90%		

	120V MODEL	SX-BDL-1500 UPS-1500-OL	SX-BDL-2000 UPS-2000-OL	UPS-2000-OL
PHYSICAL	Dimensions	W x D x H (inches)		
	Unit Dimensions	17.3" x 25.6" x 3.4"	17.3" x 21.7" x 5.2"	
	Shipping Dimensions	22.3" x 31.4" x 9.2"	22.3" x 27.4" x 11.0"	
	Unit Weight	57.3 lbs	79.4 lbs	81.6 lbs
	Shipping Weight	68.4 lbs	91.5 lbs	93.7 lbs
	Line Cord	5-15P	5-20P	L5-30P
	Receptacles	(6) NEMA 5-15R	(1) NEMA L5-20R + (4) NEMA 5-20R	(1) NEMA L5-30R + (4) NEMA 5-20R
	Communication Interface	RS-232 or SNMP (optional card)		
Included in box	UPSILON CD, horizontal brackets, 5:1 brackets, manual, 6ft DB9 cable			
ENVIRONMENT	Operating Temperature	0 - 40°C (32 - 104°F)		
	Audible Noise	< 50dba at one meter		
	Altitude	11,500 ft (3500 m) above sea level		
WARRANTY	Warranty	Three years electronics / Three years battery		
APPROVALS	North America	UL cUL FCC		
INDICATORS & ALARMS	LCD Visual Display	Input/output voltage & frequency, on-line mode, back up mode, battery capacity, load level		
	Audible Alarm	Beep every 4 sec (on battery)		
	UPS Fault	Continuous beeping sound and LCD display		

	EXTENDED BATTERY PACK MODELS	UPS-BPX 1500	UPS-BPX-2000
INPUT	Voltage	120 VAC	
	AC Current	2.2A	4A
	Frequency	50/60 Hz auto sensing	
	Input Protection	circuit breaker	
CHARGER OUTPUT	DC Voltage	55.0 ±0.5V	110.0 ±0.5V
	DC Current	2.5A (max)	
	Output Protection	Fuse	
BATTERY	Battery Type	sealed, non-spillable, maintenance free, valve regulated, lead acid	
	Extended Battery Packs	EBP2	EBP3
	Battery Type (EBP)	2 strings of (4) 12V 7.2 AH / 48V	2 strings of (8) 12V 7.2 AH / 96V
	Recharge Time	< 4 hours to 90%	< 6 hours to 90%
PHYSICAL	Dimensions	W x D x H (inches)	
	Unit Dimensions	17.3" x 25.6" x 3.4"	17.3" x 21.7" x 5.2"
	Shipping Dimensions	22.3" x 31.4" x 9.2"	22.3" x 27.4" x 11.0"
	Unit Weight	75.0 lbs	113.6 lbs
	Shipping Weight	86.0 lbs	125.7 lbs
	Line Cord	5-15P	
	Included in box	EBP, User Manual, DC cable, AC input cord	
	EXTENDED BATTERY PACK MODELS	UPS-BPX 1500	UPS-BPX-2000
WARRANTY	Warranty	Three years electronics / Three years battery	
APPROVALS	North America	UL cUL FCC	
INDICATORS & ALARMS	LED Visual Display	Charging LED, Battery test LED	

15. Appendix A: Extended Battery Pack (EBP) User Guide

Estimated Run Time for UPS with Extended Battery Packs

MODEL	LOAD		RUNTIME FOR QTY OF EXTENDED BATTERY PACKS IN MIN.					
	VA	WATTS	UPS	(1) EPB	(2) EPB	(3) EPB	(4) EPB	(5) EPB
SX-BDL-1500 UPS-1500-OL	750	525	18	68	124	184	248	315
	1500	1050	9	32	60	90	120	152
SX-BDL-2000 UPS-2000-OL	1000	700	29	109	200	298	402	510
	2000	1400	14	52	97	144	194	247
UPS-3000-OL	1500	1050	18	67	123	184	248	315
	3000	2100	9	32	60	89	120	152

CAUTION: It is very critical to connect the correct voltage EBP with the UPS intended.

UPS-BPX-1500 is for SX-BDL-1500/UPS-1500-OL

UPS-BPX-2000 is for SX-BDL-2000/UPS-2000-OL/UPS-3000-OL

Connecting the incorrect battery pack to the UPS may result in damage to the UPS and/or battery pack will void the warranty.

All EBPs have a different DC voltage configuration intended only for the UPS's listed above. Please do not mix BPX's and make sure you only connect the EBP to like EBPs or UPS indicated above. DC voltages are marked on both the UPS and the EBP – MAKE SURE THEY MATCH.



**CAUTION LABEL ON EBP CABLE CONNECTORS –
PLEASE CHECK VOLTAGES CAREFULLY**

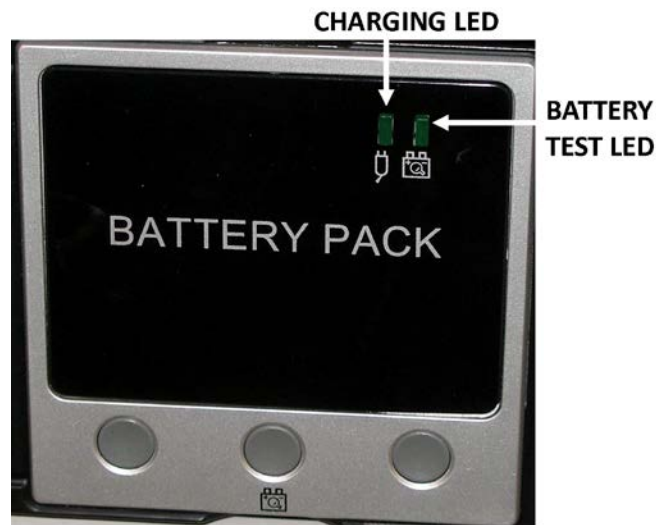
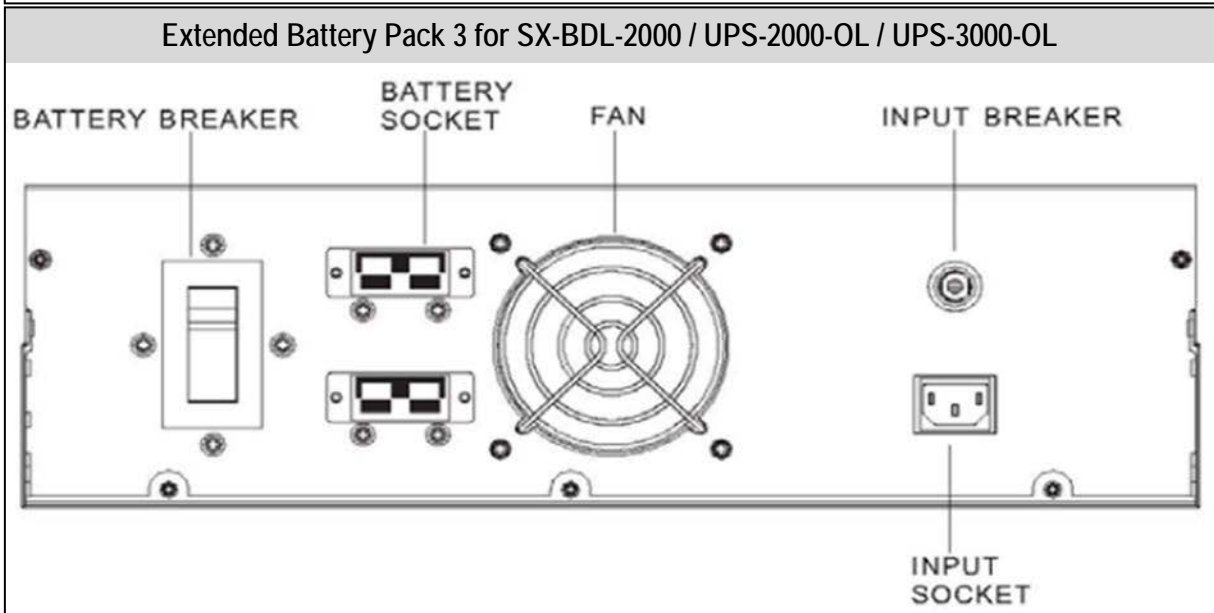
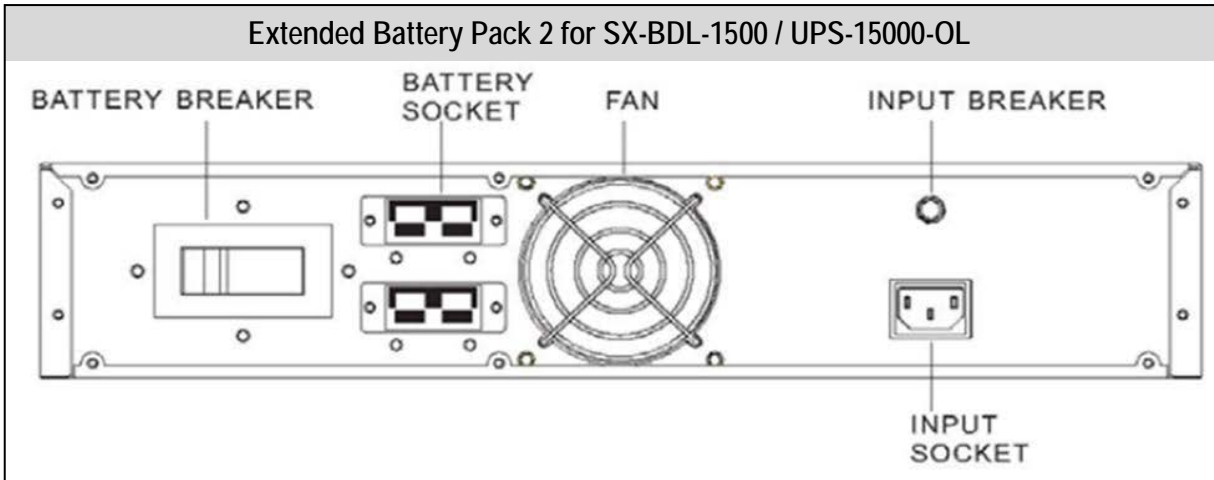

BATTERY FRONT PANEL

LED Description

The **Charging LED GREEN** indicates that the battery charger in the Extended Battery Pack is charging normally with the AC power cord attached to the Battery pack.

The **Battery Test LED GREEN** indicates that the DC output of the Extended Battery Pack (EBP) is normal. To perform the Battery Test,

- switch the breaker on the rear of the EBP to ON position
- press the Battery Test Button on the front panel of the EBP
- the DC output from the EBP is normal when the Battery Test LED is illuminated

Prior to connecting EBP's, test each EBP to assure proper operation.

Extended Battery Pack Option

The UPS System can be connected to multiple extended battery packs to increase the runtime when connected to the UPS supporting the load. Most UPS Systems are limited to one or two external battery packs because the UPS is responsible for the recharging and does not have the recharge capacity to handle the additional batteries to a full recharge. The UPS System overcomes this limitation by equipping each extended battery pack (EBP) with its own charger, providing the user a way to achieve significantly more battery backup time. Not all of the AC input power cords for the EBP's need to be connected to AC - the more you connect the faster the recharge of the batteries.

1. The DC Circuit Breaker on the rear of the EBP connects and disconnects the DC bus voltage from the EBP to the UPS. The DC Circuit Breaker will also trip to the OFF position in the event of an over-current condition in the EBP.



SX-BDL-2000 / UPS-2000-OL / UPS-3000-OL Rear View

2. The EBP's use a cable shipped with each EBP to "daisy chain" together additional EBP's to the first EBP being connected to the UPS in the appropriately labeled connector, or for connecting the first EBP to the UPS.

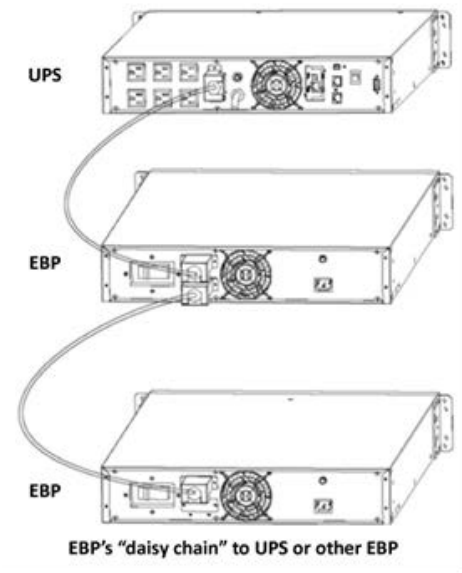

3. The AC input cord is for connecting AC utility to operate the Charger contained in each EBP



4. The input AC Circuit Breaker will trip to the OFF position in the event that the internal EBP charger draws excessive current.

Extended Battery Pack Installation

CAUTION: Extended Battery Pack (EBP) Installation should be performed by qualified service personnel.

1. Verify that the DC circuit breaker on the rear panel of the EBP is in the OFF position.
2. Turn the UPS OFF and disconnect the UPS Input Cord from the AC wall outlet.
3. Remove the EBP connector cover from the UPS rear panel.
4. Connect the external DC battery cable from the EBP to the appropriate connector on the UPS.
5. Secure the DC battery cable to both the rear of the UPS and the rear of the EBP by using M3 x 8 screws provided (2 each per connector end).
6. Repeat the above procedure for testing and securing each additional EBP required.

CAUTION: Do not use extension cords when connecting input AC power to UPS or EBP's

7. Move the DC circuit breaker on the rear of each EBP to the ON position. At this point the UPS will need to be started.
8. If the EBP's are plugged into an AC source and properly installed, the internal batteries will be charged when acceptable voltage is present. EBP's must be charged for a minimum of 6 hours for full battery time.

NOTE: If the EBP is going to be out of service or stored for six months or longer, the batteries must be recharged for at least 36 hours every six months.

Extended Battery Pack Q&A

1. Which EBP's do I connect to an AC input source?

It is possible to plug in every EBP into an AC input source. The more connected the faster the recharge time. It is recommended that every third EBP be connected to incoming AC utility to properly charge the batteries in a complete system. Leaving too many chargers connected may cause an over charge situation which could damage the batteries.

2. Which LED's are supposed to be lit on the front of each EBP?

When an EBP is connected to an AC input source and the unit is charging, a GREEN LED on the front of the EBP will be illuminated.

3. Are any LED's on the front of the EBP supposed to be lit if it is not connected to an AC input source?

No. The UPS and/or the EBP's that are plugged into an AC input source are responsible for charging the entire system. The EBP is still working and has the capability of providing DC voltage when needed. No LED on the front bezel will be illuminated.

4. The EBP is connected to an AC input source, why does the LED on the front of the EBP turn ON and OFF intermittently, and does this mean this EBP is not working?

The GREEN LED on the front of each EBP indicates that the charger contained in the EBP is charging. Under certain conditions when the batteries are 100% charged, the charger in the EBP will shut off and the LED will no longer be illuminated. This is normal operation for the EBP. The EBP is working properly.\

5. Why don't the LED's on each EBP connected to an AC input source turn ON and OFF at the same time?

The charger on each EBP functions independently from the others. One EBP charger may be charging while another one might be at 100% and the charger turned off. This is normal operation of the EBP.

16. Trademarks

Patents and Published Patent Applications – The Product may be covered by one of more of the following patents or published patent applications:

U.S. Patent Nos: RE39,446; 6,728,089; 6,744,613; 6,947,266; 7,068,487; 7,184,252; 7,511,934; 7,541,696; and 7,551,412.

U.S. Patent Application Publication Nos.: 20090303648; 20110063759; 20110102052; 20120128078; 20120130658; and 20120194955.

Canadian Patent No. 2,461,332 and Canadian Patent Application No. 2,511,695

European Patent Application Nos. EP2482085 and EP 2469554

Trademarks and Service Marks



ESP	ENERGY INTELLIGENCE	MULTI-STAGE
ECOMMANDCENTER	NEXT GEN	PCS
DIGITAL QC	SURGEX	DEFENDER SERIES
ELIMINATOR SERIES	SURGE ELIMINATION	SERIES MODE
ICE	INRUSH CURRENT ELIMINATION	COUYS
ADVANCED SERIES MODE	AXESS	CERVELLA