

Full HD Multiple Streams Box IP Camera

User Manual

Ver1.3

Table of Contents

1. Overview	2
1.1 Features	2
1.2 Package Contents	3
1.3 Dimensions	3
1.4 Connectors	4
2. Camera Cabling	5
2.1 Connect Power	5
2.2 Connect Ethernet Cable	5
2.3 Lens Mounting	6
2.4 Connect Alarm I/O	6
2.5 Connect RS485 (for DC12V/AC24V/PoE Model)	6
3. System Requirements	7
4. Access Camera	8
5. Setup Video Resolution	12
6. Configuration File Export/ Import	22
Appendix A: Technical Specifications	23
Appendix B: Delete the Existing DC Viewer	27
Appendix C: Setup Internet Security	28
Appendix D: Back Focus Adjustment	29

1. Overview

Supported with both H.264 and MJPEG standard, the product series not only features in superior Full HD resolution for real-time streaming at 25/30 fps, but also supplies D1 720p real-time streaming. With more computing power, the IP Camera could provide more flexibility for users and system managers.

1.1 Features

- Progressive Scan CMOS Sensor
- Dual Streams, Full HD real-time + D1 real-time
- H.264 and MJPEG Compression
- Motion Detection
- Privacy Masks
- WDR
- Smart Picture Quality/3DNR
- Day/Night (ICR) (optional)
- Auto Iris Lens support (optional)
- Micro SD support (optional)
- BNC Analog output
- PoE support
- ONVIF Support

1.2 Package Contents

Please check the package contains the following items listed below.

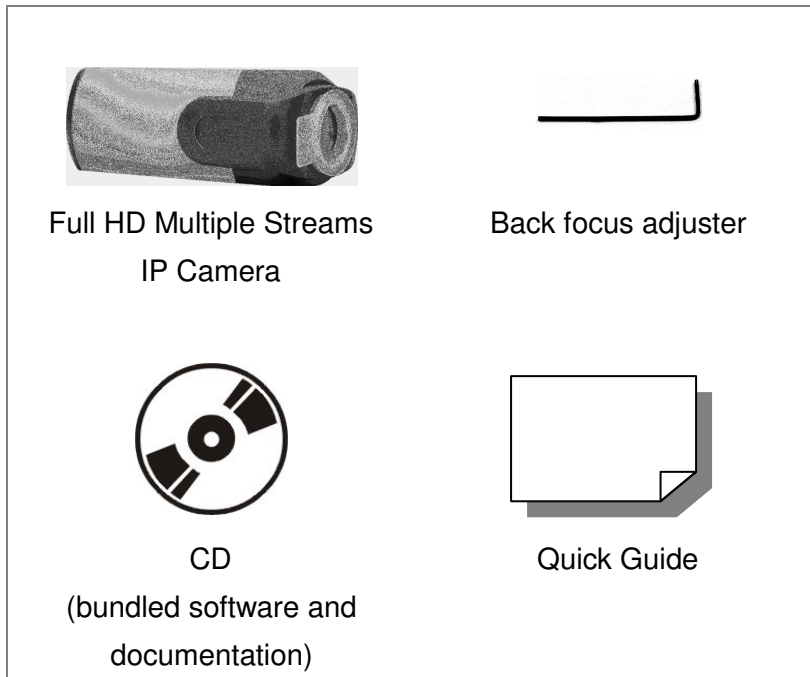

1.3 Dimensions

The IP Camera's dimensions are shown below.

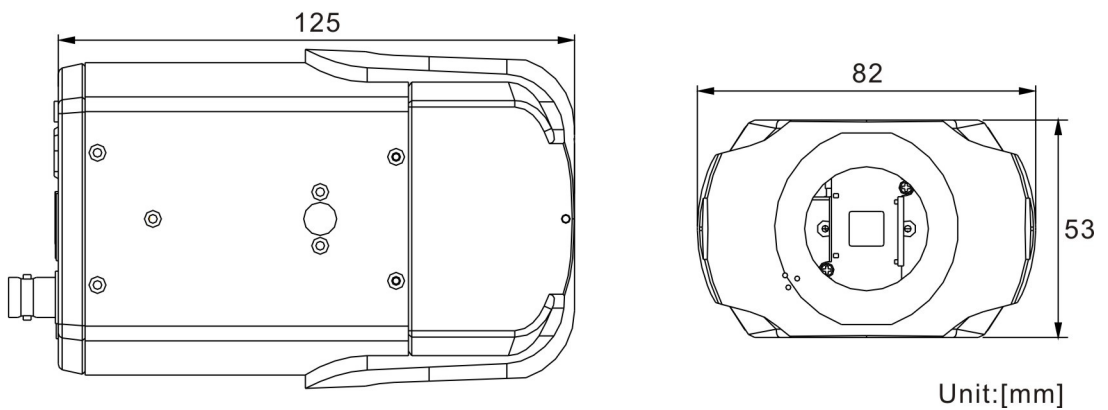

1.4 Connectors

The diagram below shows the IP Camera's reset button and various connectors. Definition for each connector will be given as follows.

DC 12V/ PoE

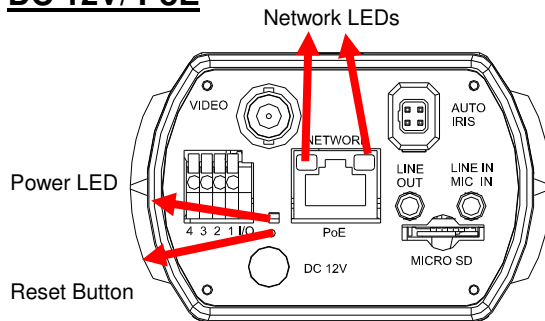

DC 12V/ AC 24V/ PoE

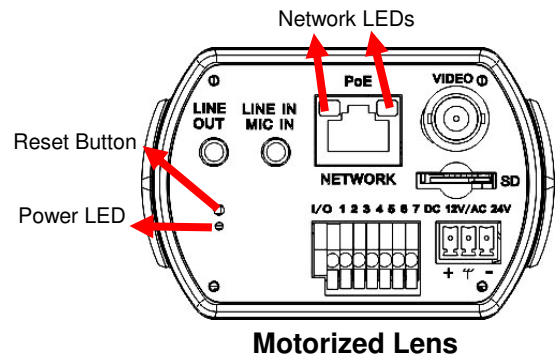
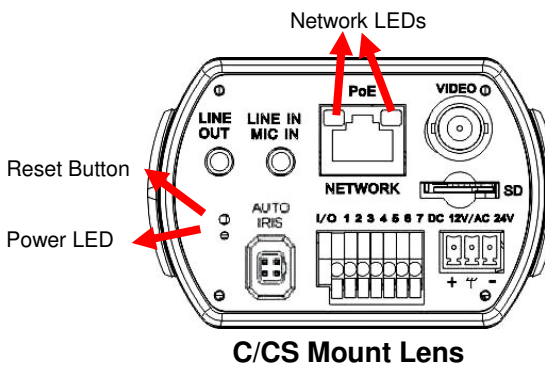

Definition	Remarks			
LINE OUT & LINE IN / MIC IN	Two-way audio transmission			
Power LED	Power connection indication (green light)			
Reset button	Reset to factory default			
AUTO IRIS connector	Auto iris lens connector			
NETWORK (with PoE)	RJ-45 connector			
Network LEDs	Network connection and activity indication			
I/O	1	Output +	5	GND
	2	Output -	6	D -
	3	Input +	7	D +
	4	Input -		
VIDEO (BNC connector)	For video output			
Micro SD Card slot	For video and snapshots storage			
AC 24V/DC 12V connector (AC 24V Model)	+	AC 24V: Power-1	DC 12V: Power	
	⏏	AC 24V: Earth GND	DC 12V: Reserved	
	-	AC 24V: Power-2	DC 12V: GND	

2. Camera Cabling

Please follow the instructions below to complete IP Camera installation.

2.1 Connect Power

Please refer to [Section: Connectors](#). Alternatively, connect the Ethernet cable to the camera's PoE port and plug the other end of the cable into a PoE switch.



NOTE: If using PoE, make sure Power Sourcing Equipment (PSE) is in use in the network.

2.2 Connect Ethernet Cable

Use of Category 5 Ethernet cable is recommended for network connection; to have best transmission quality, cable length shall not exceed 100 meters. Connect one end of the Ethernet cable to the RJ-45 connector of the IP Camera, and the other end of the cable to the network switch or PC.



NOTE: In some cases, you may need use an Ethernet crossover cable when connecting the IP Camera directly to the PC.

Check the status of the link indicator and activity indicator LEDs; if the LEDs are unlit, please check LAN connection.

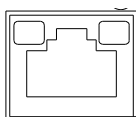

Green Link Light indicates good network connection.

Orange Activity Light flashes for network activity indication.

2.3 Lens Mounting

If use C-Mount lens, after removing the camera's plastic cover, users need to mount the C/CS mount adapter to the camera. Then attach the lens onto the C/CS mount adapter, as the illustrations shown below.

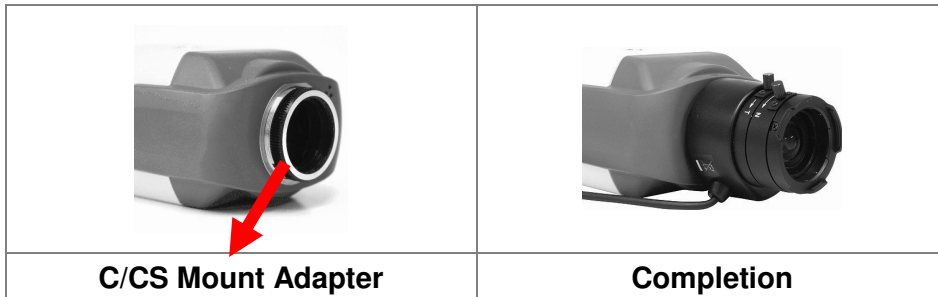

2.4 Connect Alarm I/O

The camera equips one alarm input and one relay output for alarm application. Refer to alarm pin definition below to connect alarm devices to the IP Camera if needed.

DC 12V/ PoE

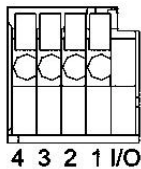

- PIN 1: Output+
- PIN 2: Output-
- PIN 3: Input+
- PIN 4: Input-

DC 12V/ AC 24V/ PoE

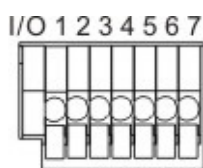

2.5 Connect RS485 (for DC12V/AC24V/PoE Model)

The RS-485 connector is the interface for connecting with the pan & tilt positioning system.

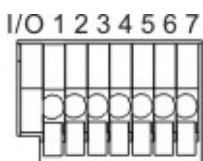

- PIN 6: D-
- PIN 7: D+

3. System Requirements

To perform the IP Camera via web browser, please ensure your PC is in good network connection, and meet system requirements as described below.

Items	System Requirement
Personal Computer	1. Intel® Pentium® M, 2.16 GHz or Intel® Core™2 Duo, 2.0 GHz 2. 2 GB RAM or more
Operating System	Windows VISTA/ Windows XP/ Windows 7
Web Browser	Microsoft Internet Explorer 6.0 or later Firefox Chrome Safari
Network Card	10Base-T (10 Mbps) or 100Base-TX (100 Mbps) operation
Viewer	ActiveX control plug-in for Microsoft IE

4. Access Camera

For initial access to the IP Camera, users can search the camera through the installer program: DeviceSearch.exe, which can be found in “DeviceSearch” folder in the supplied CD.

Device Search Software Setup

Step 1: Double click on the program Device Search.exe. After its window appears, click on the <Device Search> button on the top side.

Step 2: The security alert window will pop up. Click on <Unblock> to continue.

Device Search

Step 3: Click on <Device Search> again, and all the finding IP devices will be listed in the page. The IP Camera’s default IP address is: **192.168.0.250**.

Step 4: Double click or right click and select <Browse> to access the camera directly via web browser.

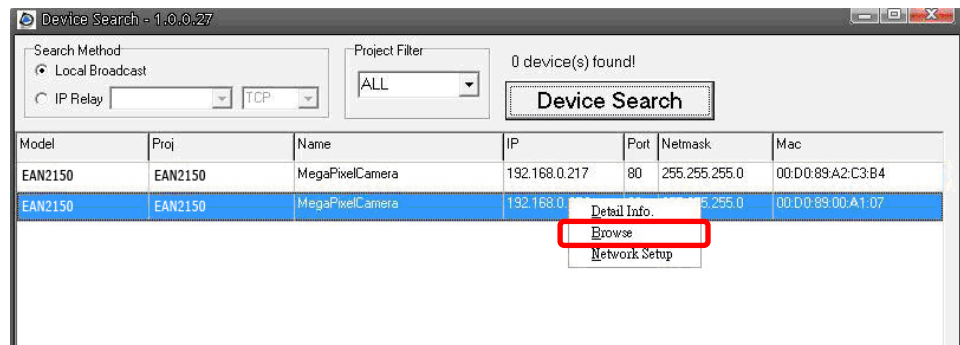

Step 5: Then the prompt window of request for entering default username and password will appear for logging in to the IP Camera.

The default login ID and password for the Administrator are:

Login ID	Password
Admin	1234



NOTE: ID and password are case sensitive.



NOTE: It is strongly advised that administrator's password be altered for the security concerns. Refer to [Full HD Multiple Streams IP Camera Menu Tree](#) for further details.

Additionally, users can change the IP Camera's network property, either DHCP or Static IP, directly in the device finding list. Refer to the following section for changing the IP Camera's network property.

Example of Changing IP Camera's Network Property

Users can directly change an IP Camera's network property, ex. from static IP to DHCP, in the finding device list. The way to change the IP Camera's network property is specified below:

Step 1: In the finding device list, click on the IP Camera that you would like to change its network property. On the selected item, right click and select "Network Setup." Meanwhile, record the IP Camera's MAC address, for future identification.

Step 2: The "Network Setup" page will come out. Select "DHCP," and press "Apply" button down the page.

Step 3: Click on <OK> on the Note of setting change. Wait for one minute to re-search the IP Camera.

Step 4: Click on the <Device Search> button to search all the devices. Then select the IP Camera with the correct MAC address. Double click on the IP Camera, and the login window will come out.

Step 5: Enter User name and Password to access the IP Camera.

Installing DC Viewer Software Online

For the initial access to the IP Camera, a client program, DC Viewer, will be automatically installed to your PC when connecting to the IP Camera.

If the Web browser doesn't allow DC Viewer installation, please check the Internet security settings or ActiveX controls and plug-ins settings (refer to [Section: Setup Internet Security](#)) to continue the process.

The Information Bar (just below the URL bar) may come out and ask for permission to install the ActiveX Control for displaying video in browser. Right

click on the Information Bar and select <Install ActiveX Control...> to allow the installation.

The download procedure of DC Viewer software is specified as follows.

Step 1: In the DC Viewer installation window, click on <Next> to start installation.

Step 2: The status bar will show the installation progress. After the installation is completed, click on <Finish> to exit the installation process.

Step 3: Click on <Finish> to close the DC Viewer installation page.

Once the DC Viewer is successfully installed, the IP Camera's Home page will be able to correctly display as the figure below.

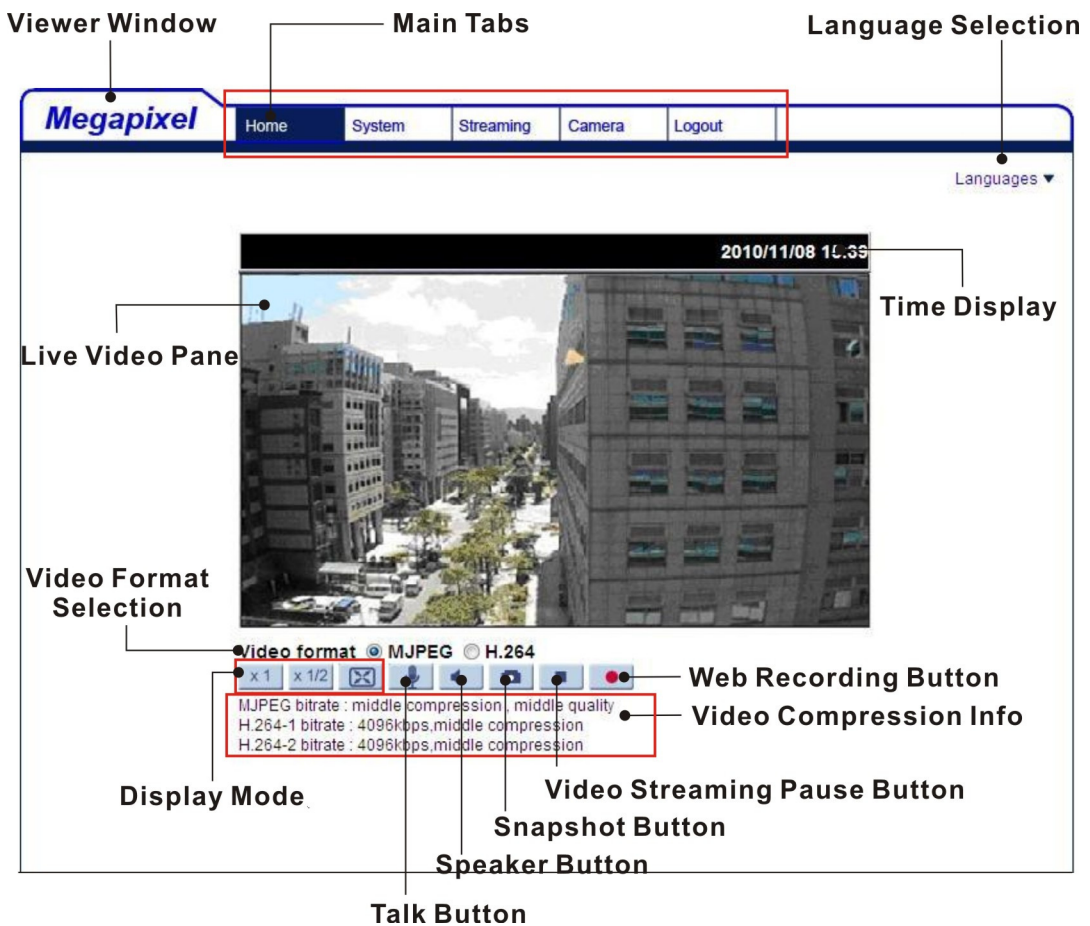

Image and Focus Adjustment

The image displays on the Home page when successfully accessing to the IP Camera. Adjust zoom and focus as necessary to produce a clear image.



Note: Please refer to [Full HD Multiple Streams IP Camera Menu Tree](#) for more button function detail.

5. Setup Video Resolution

Users can setup Video Resolution on Video Format page of the user-friendly browser-based configuration interface.

Video Format can be found under this path: **Streaming> Video Format**.

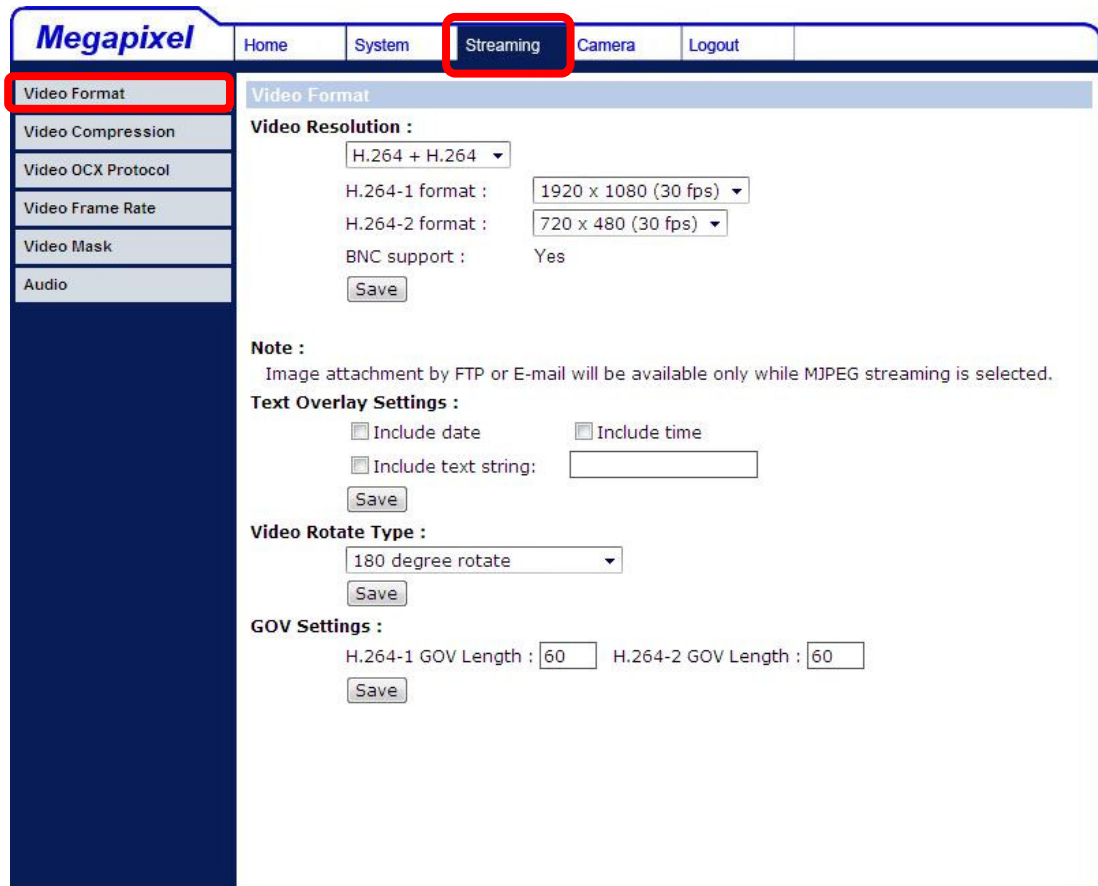

The screenshot displays the Megapixel configuration interface. The top navigation bar includes 'Home', 'System', 'Streaming', 'Camera', and 'Logout'. The 'Streaming' menu item is highlighted with a red box. On the left sidebar, the 'Video Format' option is also highlighted with a red box. The main content area is titled 'Video Format' and contains the following settings:

- Video Resolution :**
 - Format: H.264 + H.264
 - H.264-1 format : 1920 x 1080 (30 fps)
 - H.264-2 format : 720 x 480 (30 fps)
 - BNC support : Yes
 - Save button
- Note :**

Image attachment by FTP or E-mail will be available only while MJPEG streaming is selected.
- Text Overlay Settings :**
 - Include date
 - Include time
 - Include text string: [text input field]
 - Save button
- Video Rotate Type :**
 - 180 degree rotate
 - Save button
- GOV Settings :**
 - H.264-1 GOV Length : [60]
 - H.264-2 GOV Length : [60]
 - Save button

Click on <Save> to confirm the setting.

2M Model

- **Video Format**

The available Video Resolution for MJPEG & H.264 format includes:

H.264 + H.264		
H.264-1	H.264-2	BNC SUPPORT
1920 x 1080 (30fps)	720 x 480 (30fps)*	√
	640 x 480 (30fps)	√
	352 x 240 (30fps)	√
1920 x 1080 (15fps)	1920 x 1080 (15fps)	√
	1280 x 1024 (30fps)	√
	1280 x 720 (30fps)	√
	1024 x 768 (30fps)	√
	800 x 600 (30fps)	-
	720 x 480 (30fps)	√
	640 x 480 (30fps)	√
	352 x 240 (30fps)	√
1280 x 1024 (30fps)	1280 x 1024 (15fps)	√
	1280 x 720 (30fps)	-
	1024 x 768 (30fps)	-
	800 x 600 (30fps)	-
	720 x 480 (30fps)	√
	640 x 480 (30fps)	√
	352 x 240 (30fps)	√
1280 x 720 (30fps)	1280 x 720 (30fps)	√
	1024 x 768 (30fps)	-
	800 x 600 (30fps)	-
	720 x 480 (30fps)	√
	640 x 480 (30fps)	√
	352 x 240 (30fps)	√
1024 x 768 (30fps)	1024 x 768 (30fps)	√
	800 x 600 (30fps)	-
	720 x 480 (30fps)	√
	640 x 480 (30fps)	√
	352 x 240 (30fps)	√

800 x 600 (30fps)	800 x 600 (30fps)	√
	720 x 480 (30fps)	√
	640 x 480 (30fps)	√
	352 x 240 (30fps)	√
720 x 480 (30fps)	720 x 480 (30fps)	√
	640 x 480 (30fps)	√
	352 x 240 (30fps)	√
640 x 480 (30fps)	640 x 480 (30fps)	√
	352 x 240 (30fps)	√
352 x 240 (30fps)	352 x 240 (30fps)	-
H.264 + MJPEG		
H.264	MJPEG	BNC SUPPORT
1920 x 1080 (30fps)	720 x 480 (30fps)	√
	640 x 480 (30fps)	√
	352 x 240 (30fps)	√
1920 x 1080 (15fps)	1920 x 1080 (15fps)	√
	1280 x 1024 (30fps)	√
	1280 x 720 (30fps)	√
	1024 x 768 (30fps)	√
	800 x 600 (30fps)	-
	720 x 480 (30fps)	√
	640 x 480 (30fps)	√
	352 x 240 (30fps)	√
1280 x 1024 (30fps)	1280 x 1024 (15fps)	√
	1280 x 720 (30fps)	-
	1024 x 768 (30fps)	-
	800 x 600 (30fps)	-
	720 x 480 (30fps)	√
	640 x 480 (30fps)	√
	352 x 240 (30fps)	√
1280 x 720 (30fps)	1280 x 720 (30fps)	√
	1024 x 768 (30fps)	-
	800 x 600 (30fps)	-
	720 x 480 (30fps)	√
	640 x 480 (30fps)	√
	352 x 240 (30fps)	√

1024 x 768 (30fps)	1024 x 768 (30fps)	√
	800 x 600 (30fps)	-
	720 x 480 (30fps)	√
	640 x 480 (30fps)	√
	352 x 240 (30fps)	√
800 x 600 (30fps)	800 x 600 (30fps)	√
	720 x 480 (30fps)	√
	640 x 480 (30fps)	√
	352 x 240 (30fps)	√
720 x 480 (30fps)	720 x 480 (30fps)	√
	640 x 480 (30fps)	√
	352 x 240 (30fps)	√
640 x 480 (30fps)	640 x 480 (30fps)	√
	352 x 240 (30fps)	√
352 x 240 (30fps)	352 x 240 (30fps)	-
MJPEG Only		
MJPEG		BNC SUPPORT
1920 x 1080 (30fps)		√
1280 x 1024 (30fps)		√
1280 x 720 (30fps)		√
1024 x 768 (30fps)		√
800 x 600 (30fps)		√
720 x 480 (30fps)		√
640 x 480 (30fps)		√
352 x 240 (30fps)		-
H.264 Only		
H.264		BNC SUPPORT
1920 x 1080 (30fps)		√
1280 x 1024 (30fps)		√
1280 x 720 (30fps)		√
1024 x 768 (30fps)		√
800 x 600 (30fps)		√
720 x 480 (30fps)		√
640 x 480 (30fps)		√
352 x 240 (30fps)		-

(*) Default

3M Model

- **Video Format**

User Video Resolution section, select a preferred resolution setting. The available Video Resolution for MJPEG & H.264 format includes:

H.264 + H.264		
H.264-1	H.264-2	BNC SUPPORT
1920 x 1080 (30fps)	720 x 480 (30fps)*	√
	640 x 480 (30fps)	√
	352 x 240 (30fps)	√
1920 x 1080 (15fps)	1920 x 1080 (15fps)	√
	1280 x 1024 (30fps)	√
	1280 x 720 (30fps)	√
	1024 x 768 (30fps)	√
	800 x 600 (30fps)	-
	720 x 480 (30fps)	√
	640 x 480 (30fps)	√
	352 x 240 (30fps)	√
1280 x 1024 (30fps)	1280 x 1024 (15fps)	√
	1280 x 720 (30fps)	-
	1024 x 768 (30fps)	-
	800 x 600 (30fps)	-
	720 x 480 (30fps)	√
	640 x 480 (30fps)	√
	352 x 240 (30fps)	√
1280 x 720 (30fps)	1280 x 720 (30fps)	√
	1024 x 768 (30fps)	-
	800 x 600 (30fps)	-
	720 x 480 (30fps)	√
	640 x 480 (30fps)	√
	352 x 240 (30fps)	√
1024 x 768 (30fps)	1024 x 768 (30fps)	√
	800 x 600 (30fps)	-
	720 x 480 (30fps)	√
	640 x 480 (30fps)	√
	352 x 240 (30fps)	√

800 x 600 (30fps)	800 x 600 (30fps)	√
	720 x 480 (30fps)	√
	640 x 480 (30fps)	√
	352 x 240 (30fps)	√
720 x 480 (30fps)	720 x 480 (30fps)	√
	640 x 480 (30fps)	√
	352 x 240 (30fps)	√
640 x 480 (30fps)	640 x 480 (30fps)	√
	352 x 240 (30fps)	√
352 x 240 (30fps)	352 x 240 (30fps)	-
H.264 + MJPEG		
H.264	MJPEG	BNC SUPPORT
1920 x 1080 (30fps)	720 x 480 (30fps)	√
	640 x 480 (30fps)	√
	352 x 240 (30fps)	√
1920 x 1080 (15fps)	1920 x 1080 (15fps)	√
	1280 x 1024 (30fps)	√
	1280 x 720 (30fps)	√
	1024 x 768 (30fps)	√
	800 x 600 (30fps)	-
	720 x 480 (30fps)	√
	640 x 480 (30fps)	√
	352 x 240 (30fps)	√
1280 x 1024 (30fps)	1280 x 1024 (15fps)	√
	1280 x 720 (30fps)	-
	1024 x 768 (30fps)	-
	800 x 600 (30fps)	-
	720 x 480 (30fps)	√
	640 x 480 (30fps)	√
	352 x 240 (30fps)	√
1280 x 720 (30fps)	1280 x 720 (30fps)	√
	1024 x 768 (30fps)	-
	800 x 600 (30fps)	-
	720 x 480 (30fps)	√
	640 x 480 (30fps)	√
	352 x 240 (30fps)	√

1024 x 768 (30fps)	1024 x 768 (30fps)	√
	800 x 600 (30fps)	-
	720 x 480 (30fps)	√
	640 x 480 (30fps)	√
	352 x 240 (30fps)	√
800 x 600 (30fps)	800 x 600 (30fps)	√
	720 x 480 (30fps)	√
	640 x 480 (30fps)	√
	352 x 240 (30fps)	√
720 x 480 (30fps)	720 x 480 (30fps)	√
	640 x 480 (30fps)	√
	352 x 240 (30fps)	√
640 x 480 (30fps)	640 x 480 (30fps)	√
	352 x 240 (30fps)	√
352 x 240 (30fps)	352 x 240 (30fps)	-
MJPEG Only		
MJPEG		BNC SUPPORT
1920 x 1080 (30fps)		√
1280 x 1024 (30fps)		√
1280 x 720 (30fps)		√
1024 x 768 (30fps)		√
800 x 600 (30fps)		√
720 x 480 (30fps)		√
640 x 480 (30fps)		√
352 x 240 (30fps)		-
H.264 Only		
H.264		BNC SUPPORT
2048 x 1536 (15fps)		√
1920 x 1080 (30fps)		√
1280 x 1024 (30fps)		√
1280 x 720 (30fps)		√
1024 x 768 (30fps)		√
800 x 600 (30fps)		√
720 x 480 (30fps)		√
640 x 480 (30fps)		√
352 x 240 (30fps)		-

(*) Default

5M Model

- **Video Format**

User Video Resolution section, select a preferred resolution setting. The available Video Resolution for MJPEG & H.264 format includes:

H.264 + H.264		
H.264-1	H.264-2	BNC SUPPORT
1920 x 1080 (30fps)	720 x 480 (30fps)*	√
	640 x 480 (30fps)	√
	352 x 240 (30fps)	√
1920 x 1080 (15fps)	1920 x 1080 (15fps)	√
	1280 x 1024 (30fps)	√
	1280 x 720 (30fps)	√
	1024 x 768 (30fps)	√
	800 x 600 (30fps)	-
	720 x 480 (30fps)	√
	640 x 480 (30fps)	√
	352 x 240 (30fps)	√
1280 x 1024 (30fps)	1280 x 1024 (15fps)	√
	1280 x 720 (30fps)	-
	1024 x 768 (30fps)	-
	800 x 600 (30fps)	-
	720 x 480 (30fps)	√
	640 x 480 (30fps)	√
	352 x 240 (30fps)	√
1280 x 720 (30fps)	1280 x 720 (30fps)	√
	1024 x 768 (30fps)	-
	800 x 600 (30fps)	-
	720 x 480 (30fps)	√
	640 x 480 (30fps)	√
	352 x 240 (30fps)	√
1024 x 768 (30fps)	1024 x 768 (30fps)	√
	800 x 600 (30fps)	-
	720 x 480 (30fps)	√
	640 x 480 (30fps)	√
	352 x 240 (30fps)	√

800 x 600 (30fps)	800 x 600 (30fps)	√
	720 x 480 (30fps)	√
	640 x 480 (30fps)	√
	352 x 240 (30fps)	√
720 x 480 (30fps)	720 x 480 (30fps)	√
	640 x 480 (30fps)	√
	352 x 240 (30fps)	√
640 x 480 (30fps)	640 x 480 (30fps)	√
	352 x 240 (30fps)	√
352 x 240 (30fps)	352 x 240 (30fps)	-
H.264 + MJPEG		
H.264	MJPEG	BNC SUPPORT
1920 x 1080 (30fps)	720 x 480 (30fps)*	√
	640 x 480 (30fps)	√
	352 x 240 (30fps)	√
1920 x 1080 (15fps)	1920 x 1080 (15fps)	√
	1280 x 1024 (30fps)	√
	1280 x 720 (30fps)	√
	1024 x 768 (30fps)	√
	800 x 600 (30fps)	-
	720 x 480 (30fps)	√
	640 x 480 (30fps)	√
	352 x 240 (30fps)	√
1280 x 1024 (30fps)	1280 x 1024 (15fps)	√
	1280 x 720 (30fps)	-
	1024 x 768 (30fps)	-
	800 x 600 (30fps)	-
	720 x 480 (30fps)	√
	640 x 480 (30fps)	√
	352 x 240 (30fps)	√
1280 x 720 (30fps)	1280 x 720 (30fps)	√
	1024 x 768 (30fps)	-
	800 x 600 (30fps)	-
	720 x 480 (30fps)	√
	640 x 480 (30fps)	√
	352 x 240 (30fps)	√

1024 x 768 (30fps)	1024 x 768 (30fps)	√
	800 x 600 (30fps)	-
	720 x 480 (30fps)	√
	640 x 480 (30fps)	√
	352 x 240 (30fps)	√
800 x 600 (30fps)	800 x 600 (30fps)	√
	720 x 480 (30fps)	√
	640 x 480 (30fps)	√
	352 x 240 (30fps)	√
720 x 480 (30fps)	720 x 480 (30fps)	√
	640 x 480 (30fps)	√
	352 x 240 (30fps)	√
640 x 480 (30fps)	640 x 480 (30fps)	√
	352 x 240 (30fps)	√
352 x 240 (30fps)	352 x 240 (30fps)	-
MJPEG Only		
MJPEG		BNC SUPPORT
1920 x 1080 (30fps)		√
1280 x 1024 (30fps)		√
1280 x 720 (30fps)		√
1024 x 768 (30fps)		√
800 x 600 (30fps)		√
720 x 480 (30fps)		√
640 x 480 (30fps)		√
352 x 240 (30fps)		-
H.264 Only		
H.264		BNC SUPPORT
2592 x 1944 (10fps)		√
2048 x 1536 (20fps)		√
1920 x 1080 (30fps)		√
1280 x 1024 (30fps)		√
1280 x 720 (30fps)		√
1024 x 768 (30fps)		√
800 x 600 (30fps)		√
720 x 480 (30fps)		√
640 x 480 (30fps)		√
352 x 240 (30fps)		-

(*) Default

6. Configuration File Export/ Import

To export/ import configuration files, users can access the Maintenance page on the user-friendly browser-based configuration interface.

The Maintenance setting can be found under this path: **System> Maintenance**.

Users can export configuration files to a specified location and retrieve data by uploading an existing configuration file to the IP Camera. It is especially convenient to make multiple cameras having the same configuration.

Export

Users can save the system settings by exporting the configuration file (.bin) to a specified location for future use. Click on the <Export> button, and the popup File Download window will come out. Click on <Save> and specify a desired location for saving the configuration file.

Upload

To copy an existing configuration file to the IP Camera, please first click on <Browse> to select the configuration file, and then click on the <Upload> button for uploading.

Appendix A: Technical Specifications

Camera		2M
Image Sensor		1/2.7" Progressive CMOS
Effective Pixels		1920(H) x 1080(V)
Minimum Illumination	Color	0.2 lux @ F1.2
	B/W	0.02 lux @ F1.2
Shutter Speed		1~ 1/10000 sec.
White Balance		Manual / AWB / ATW
Operation		
Video Compression		H.264 / MJPEG
Video Streaming		Simultaneous H.264 1080p (25/30 fps) + MJPEG D1 (25/30 fps)
		Simultaneous H.264 1080p (25/30 fps) + H.264 D1 (25/30 fps)
Resolution	H.264	Full HD 1080p/ SXGA/ HD 720p/ XGA/ SVGA/ D1/ VGA/ CIF
	MJPEG	
Image Setting	Brightness	Manual
	Exposure	Auto / Manual
	Sharpness	Manual
	Contrast	Manual
	White Balance	Auto / Manual
	Saturation	Manual
	Backlight Compensation	On / Off
	Hue	Manual
	Digital Zoom	Support
	WDR	On / Off
	3D Noise Reduction	On / Off
	Motion detection	On / Off
	Privacy Mask	On / Off
	Privacy Mask Type	Color
	ICR *	Auto / On / Off
Tampering Alarm	On / Off	
Audio	Two-way Audio	Line out, Line in/Mic in
	Compression	G.711 / G.726
Alarm	Input	5V 10kΩ pull up
	Output	Photo Relay Output 300VDC / AC
Event Notification		HTTP, FTP, SMTP
Multiple Languages		English, French, German, Italian, Korean, Simplified Chinese, Russian
Network		
Interface		10/100Mbps Ethernet (RJ-45)
Protocol		IPv4/ IPv6, TCP/IP, UDP, RTP, RTSP, HTTP, HTTPS, ICMP, FTP, SMTP, DHCP, PPPoE, UPnP, IGMP, SNMP, QoS, and ONVIF
Password Levels		User and Administrator
Security		HTTPS, IP Filter, IEEE 802.1X
Internet Browser		Internet Explorer (6.0+), Chrome, FireFox, Safari
User Account		20
Mechanical		

Lens Mounting		C / CS mount
Connectors	Power	DC jack
	Ethernet	RJ-45
	Micro SD	Micro SDHC 32GB support
	Audio	Stereo phone jack, \varnothing 3.5 mm
	Alarm	4 pins terminal block, pitch 3.5 mm
	Auto Iris	DC Drive
	Analog Video	1.0 Vp-p / 75 Ω , BNC
	RS-485*	D+, D-
LED Indicator		Power, Link, ACT
General		
Operating Temperature		-10 °C ~ 50 °C (14 °F ~ 122 °F) Humidity: 10% to 90%, No Condensation
Power Source		DC 12V / AC 24V / PoE
		DC 12V / PoE
Power Consumption		4W
Regulatory		CE, FCC, RoHS Compliant
Dimensions		125 x 82 x 52 mm (L x W x H) (w/o lens)
Weight		330 g (0.73 lbs)

(*) Optional

Camera		3M	5M
Image Sensor		3M SONY Progressive Scan CMOS	5M Progressive Scan CMOS
Picture Elements		2048 (H) x 1536 (V)	2592 (H) x 1944 (V)
Shutter Speed		1~ 1/10000 sec.	
White Balance		Manual / AWB / ATW	
Operation			
Video Compression		H.264 / MJPEG	
Video Streaming		Single Stream: 2048 x 1536 (15fps)	Single Stream: 2592 x 1944 (10 fps) Single Stream: 2048 x 1536 (20 fps)
		Dual Streams: H.264 1080p (25/30 fps)+ MJPEG D1 (25/30 fps)	
		Dual Streams: H.264 1080p (25/30 fps)+ H.264 D1 (25/30 fps)	
Resolution	H.264	2048x1536/ Full HD 1080p/SXGA/ HD 720p/XGA/SVGA/D1/VGA/CIF	2592x1944/ 2048x1536/ Full HD 1080p/SXGA/HD 720p/XGA/ SVGA/ D1 /VGA/CIF
	MJPEG	Full HD 1080p/ SXGA/ HD 720p/ XGA/ SVGA/ D1/ VGA/ CIF	
Image Setting	Brightness	Manual	
	Exposure	Auto / Manual	
	Sharpness	Manual	
	Contrast	Manual	
	White Balance	Auto / Manual	
	Saturation	Manual	
	Hue	Manual	
	Backlight Compensation	On / Off	
	Digital Zoom	Support	
	WDR	On / Off	
	3D Noise Reduction	On / Off	
	Motion detection	On / Off	
	Privacy Mask	On / Off	
	Privacy Mask Type	Color	
	ICR *	Auto / On / Off	
Tampering Alarm	On / Off		
Audio	Two-way Audio	Line out, Line in/Mic in	
	Compression	G.711 / G.726	
Alarm	Input	5V 10kΩ pull up	
	Output	Photo Relay Output 300VDC / AC	
Event Notification		HTTP, FTP, SMTP	
Multiple Languages		English, French, German, Italian, Korean, Simplified Chinese, Russian	
Network			
Interface		10/100Mbps Ethernet (RJ-45)	
Protocol		IPv4/ IPv6, TCP/IP, UDP, RTP, RTSP, HTTP, HTTPS, ICMP, FTP, SMTP, DHCP, PPPoE, UPnP, IGMP, SNMP, QoS, and ONVIF	
Password Levels		User and Administrator	
Security		HTTPS, IP Filter, IEEE 802.1X	
Internet Browser		Internet Explorer (6.0+), Chrome, FireFox, Safari	
User Account		20	

Mechanical		
Lens Mounting		C / CS mount
Connectors	Power	DC jack
	Ethernet	RJ-45
	Micro SD	Micro SDHC 32GB support
	Audio	Stereo phone jack, ∅ 3.5 mm
	Alarm	4 pins terminal block, pitch 3.5 mm
	Auto Iris	DC Drive
	Analog Video	1.0 Vp-p / 75Ω, BNC
	RS-485*	D+, D-
LED Indicator		Power, Link, ACT
General		
Operating Temperature		-10°C ~ 50°C (14°F ~ 122°F) Humidity: 10% to 90%, No Condensation
Power Source		DC 12V / AC 24V/ PoE DC 12V / PoE
Power Consumption		3.7W 4W
Regulatory		CE, FCC, RoHS Compliant
Dimensions		125 x 82 x 52 mm (L x W x H) (w/o lens)
Weight		330 g (0.73 lbs)

(*) Optional

Appendix B: Delete the Existing DC Viewer

For users who have installed the DC Viewer in the PC previously, please first delete the existing DC Viewer from the PC before accessing to this IP Camera.

Deleting the DC Viewer

In the Windows <Start Menu>, activate <Control Panel>, and then double click on <Add or Remove Programs>. In the <Currently installed programs> list, select <DCViewer> and click on the button <Remove> to uninstall the existing DC Viewer.

Deleting Temporary Internet Files

To improve browser performance, it is suggested to clean up the all the files in the Temporary Internet Files.

The procedure is as follows:

Step 1: Click on the <Tools> tab on the menu bar and select <Internet Options>.

Step 2: Click on the <Delete> button under <Browsing history> section. Then click on the <Delete Files> button under the <Temporary Internet files> section.

Step 3: A confirmation window will pop up. Click on <Yes> to start deleting the files.

Appendix C: Setup Internet Security

If ActiveX control installation is blocked, please either set Internet security level to default or change ActiveX controls and plug-ins settings.

Internet Security Level: Default

Step 1: Start the Internet Explorer (IE).

Step 2: Click on the <Tools> tab on the menu bar and select <Internet Options>.

Step 3: Click on the <Security> tab, and select <Internet> zone.

Step 4: Down the page, click on the <Default Level> button and click on <OK> to confirm the setting. Close the browser window, and restart a new one later to access the IP Camera.

ActiveX Controls and Plug-ins Settings

Step 1: Repeat **Steps 1~3** of the previous section above.

Step 2: Down the page, click on the <Custom Level> button to change ActiveX controls and plug-ins settings. The Security Settings window will pop up.

Step 3: Under <ActiveX controls and plug-ins>, set **ALL** items (as listed below) to <Enable> or <Prompt>. Please note that the items vary by IE version.

ActiveX controls and plug-ins settings:

1. Allow previously unused ActiveX controls to run without prompt.
2. Allow Scriptlets.
3. Automatic prompting for ActiveX controls.
4. Binary and script behaviors.
5. Display video and animation on a webpage that does not use external media player.
6. Download signed ActiveX controls.
7. Download unsigned ActiveX controls.
8. Initialize and script ActiveX controls not marked as safe for scripting.
9. Run ActiveX controls and plug-ins.
10. Script ActiveX controls marked safe for scripting.

Step 4: Click on <OK> to accept the settings and close the Security Settings window.

Step 5: Click on <OK> to close the Internet Options screen.

Step 6: Close the browser window, and restart a new one later to access the IP Camera.

Appendix D: Back Focus Adjustment

When to adjust back focus

Back Focus refers to the distance from the rear lens element to the camera focal plane. In most cases, it is required to adjust back focus only when the camera's lens cannot hold focus throughout its zoom range.

What requirements

Tools required when carrying out back focus adjustment include:

1. Back focus adjuster (in the IP Camera's package)
2. Test chart / contrasting object

How to adjust back focus

Step 1: Set the camera on a stable mount, with the test chart or object at least 75 feet (23 meters) away (or as far as possible).

Step 2: Make sure the iris is wide open. Therefore, it is advised to keep the environment in low light condition.

Step 3: Adjust the focus to infinite far (∞).

Step 4: Turn the zoom to the extreme telephoto position, and then focus on the subject.

Step 5: Set the zoom to wide-angle position.

Step 6: Loosen the back focus ring's retaining screw with the supplied adjuster, and adjust the back focus ring for sharp picture.

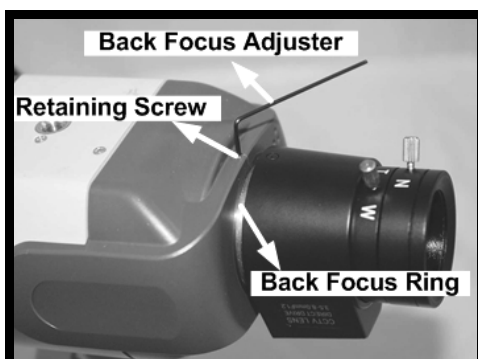

Step 7: Repeat steps 3 ~ 6 until focus can stay the same throughout the zoom range.

Step 8: Tighten the back focus ring's retaining screw to fix the ring.