

SCORPIO 23'

User's manual



INDEX

A-. Description.....	3
B-. Parts, components and functions.....	5
B1-. Dolly.....	6
B1.1 Track Wheels.....	9
B1.2 Pneumatic Wheels.....	11
B1.3 Leveling Jacks.....	13
B1.4 Steering.....	15
B1.5 Push Bar Support.....	16
B1.6 Wheel Arm Position.....	18
B2-. Telescopic column.....	22
B2.1 Process to telescope the Column.....	24
B3-. Fulcrum.....	26
B4-. The Crane Arm.....	29
B4.1-. The tubes.....	31
B4.1.1 The Main Tube	31
B4.1.1.1 Crane Arm Fixation Guides.....	33
B4.1.1.2 Protection bars.....	35
B4.1.2 Telescopic Tubes.....	36
B4.1.2.1 Hanging the Cable Looms	38
B4.2-. Conter Weight Holder.....	41
B4.2.1 Front and Back Counter Weight Holders.....	42
B4.2.2 The Sliding Weight.....	43
B4.2.3 The Moving Weight Carriage.....	44
B4.2.4 The Counter Weight.....	46
B4.2.5 Balancing the crane	48
B4.2.5.1 The Static Balancing.....	48
B4.2.5.2 The Dynamic Balancing.....	48
B5-. The Electronic Control Box.....	50
B5-.1 Functions.....	56
B5.1.1 Start up Prodecure	56
B5.1.2 Settings “Settings”.....	60
B5.1.3 Límits“Limits”.....	68
B5.1.4 The Arc Compensator “Arc Comp”.....	69
B5.1.5 Dynamic Counter Weight System Generator“CWE Gen”.....	70
B5.1.6 Motion Generator“MOTION GENERATOR”.....	70
B5.1.7 Sequential Limits “STOP SEQUENCE”.....	73
B5.2 Hand command.....	76
B6-. Leveling Head.....	78

A-. Description.

The SCORPIO 23' is a 7, 1 meter/ 23 foot telescopic crane. It has a telescopic arm range of 5, 5 meters/ 15 feet.

The crane arm is made of aluminium. It has 4 steel guides and two independent cables per tube. This provides smoother and quieter movement.

It has an electronic box which gives enough power to run the crane with a maximum controlled speed of "1,2m/s". Added features are: adjustable damping, electronic arm limits, an arc compensator, a motion generator, output encoder information, crane arm length and height, a stop sequence program and other information on a display screen.

It has a levelling head which is mounted at the end of the telescopic arm. The levelling head maintains the horizon in all positions for the Remote Camera Head.

Technical specifications.

- Weight: 600 kg. / 1322.8 lb.
- Max. weight: 1100 kg./ 2425 lb.
- Arm weight: 255 kg. / 562.2 lb.
- Fulcrum weight: 31.9 kg. / 70.3 lb
- Dolly weight: 188.5 kg / 415.6 lb.
- Max payload underslung: 70 kg / 154.3 lb.
- Max.payload overslung: 30kg. / 66.1 lb
- Max speed:1,2 m/s
- Arm length: 7,1m. / 23 ft.
- Telescopic range: 5.6m. / 15 ft.
- Rear length: 1.8m / 6 ft.

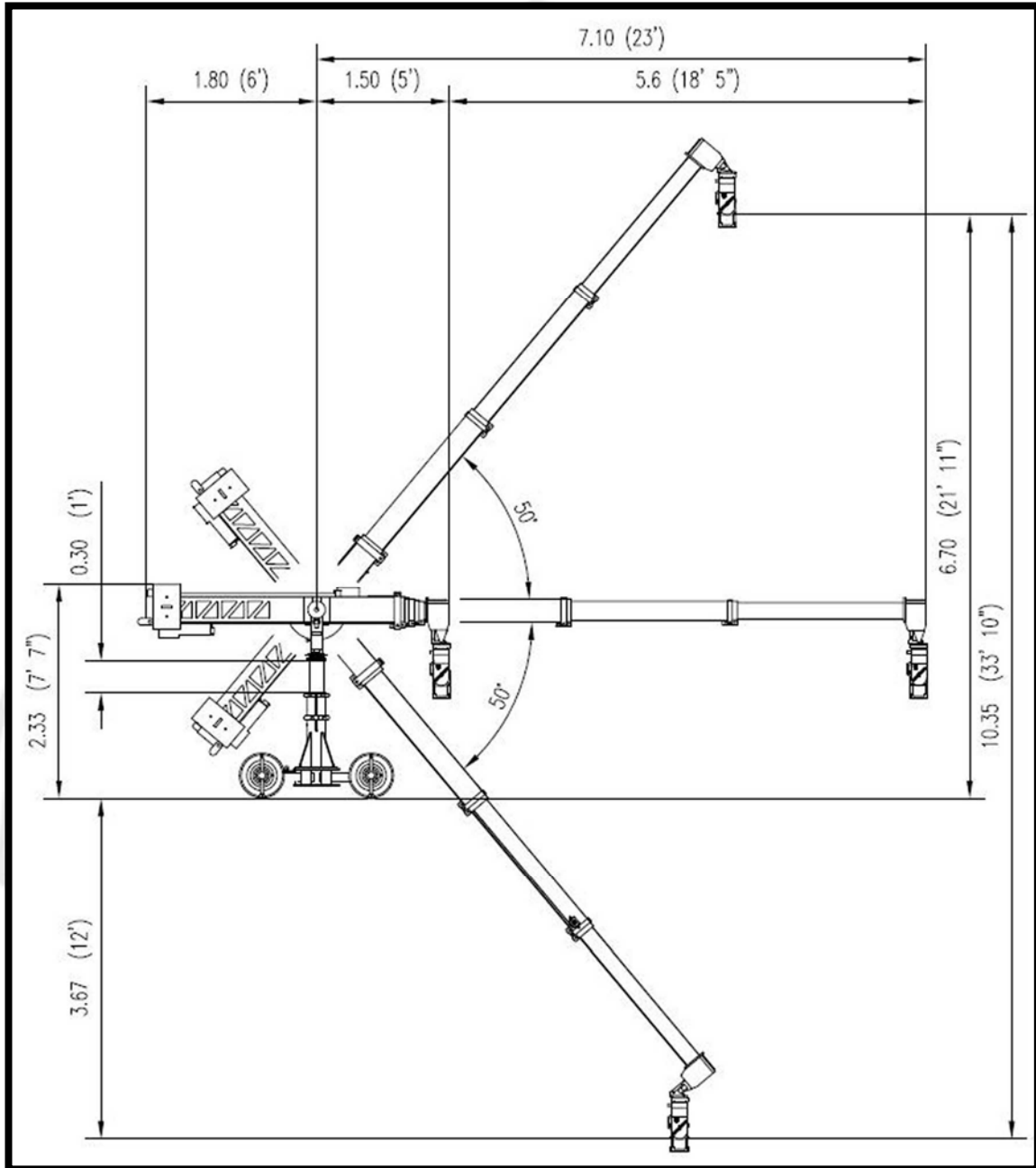

SERVICEVISION BIS SL

Ríos Rosas, 20 · 08940 CORNELLÀ DE LLOBREGAT (Barcelona) Spain · Tel. 34 93 223 86 30 · Fax 34 93 223 86 31
comercial@servicevision.es · www.servicevision.es

B-. Parts, components and functions.

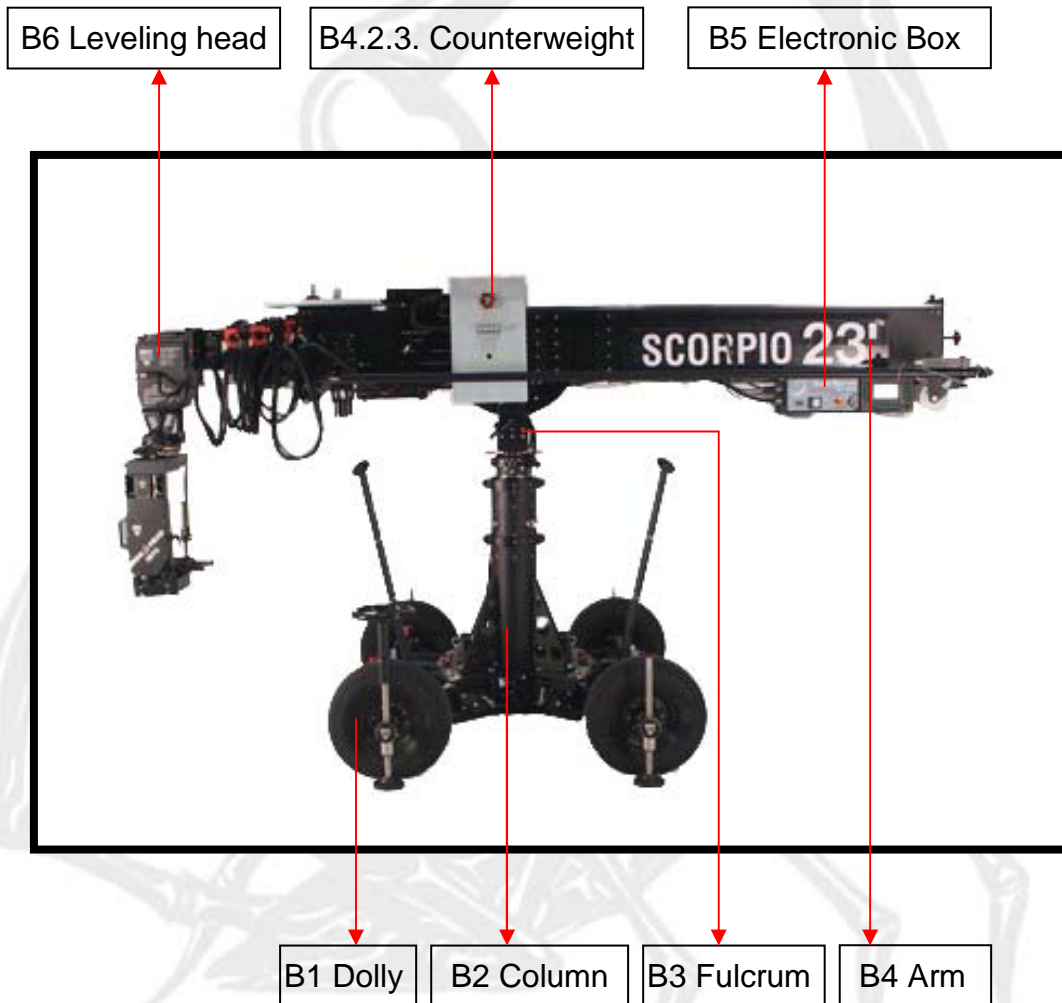

B1-. Dolly.

The SCORPIO 23' has a dolly with adjustable wheel arms and four levelling jacks. The adjustable wheel arms have three positions allowing us to use both 62cm. / 2ft. and 1m. / 3.3 ft tracks. This also gives us a major maneuverability advantage as we can pass through a regular 80cm. / 2.6 ft. doorway.

Its two independent steering handles and pneumatic wheels allow us to move the crane through tight corners.

Descripción:

- Length: 1715 mm. / 5.6'
- Width: 1345 mm. / 4.4'
- Height: 502 mm. / 1.6'
- Weight: 188.5 kg. / 415.5 lb.

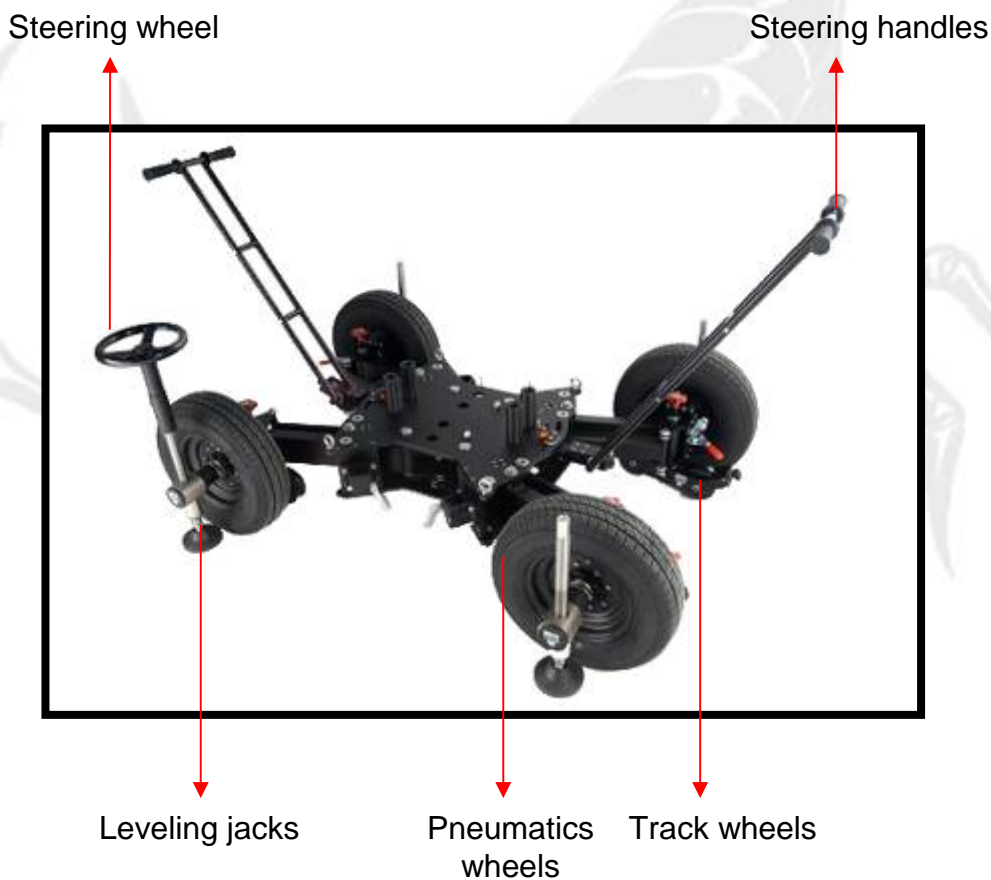

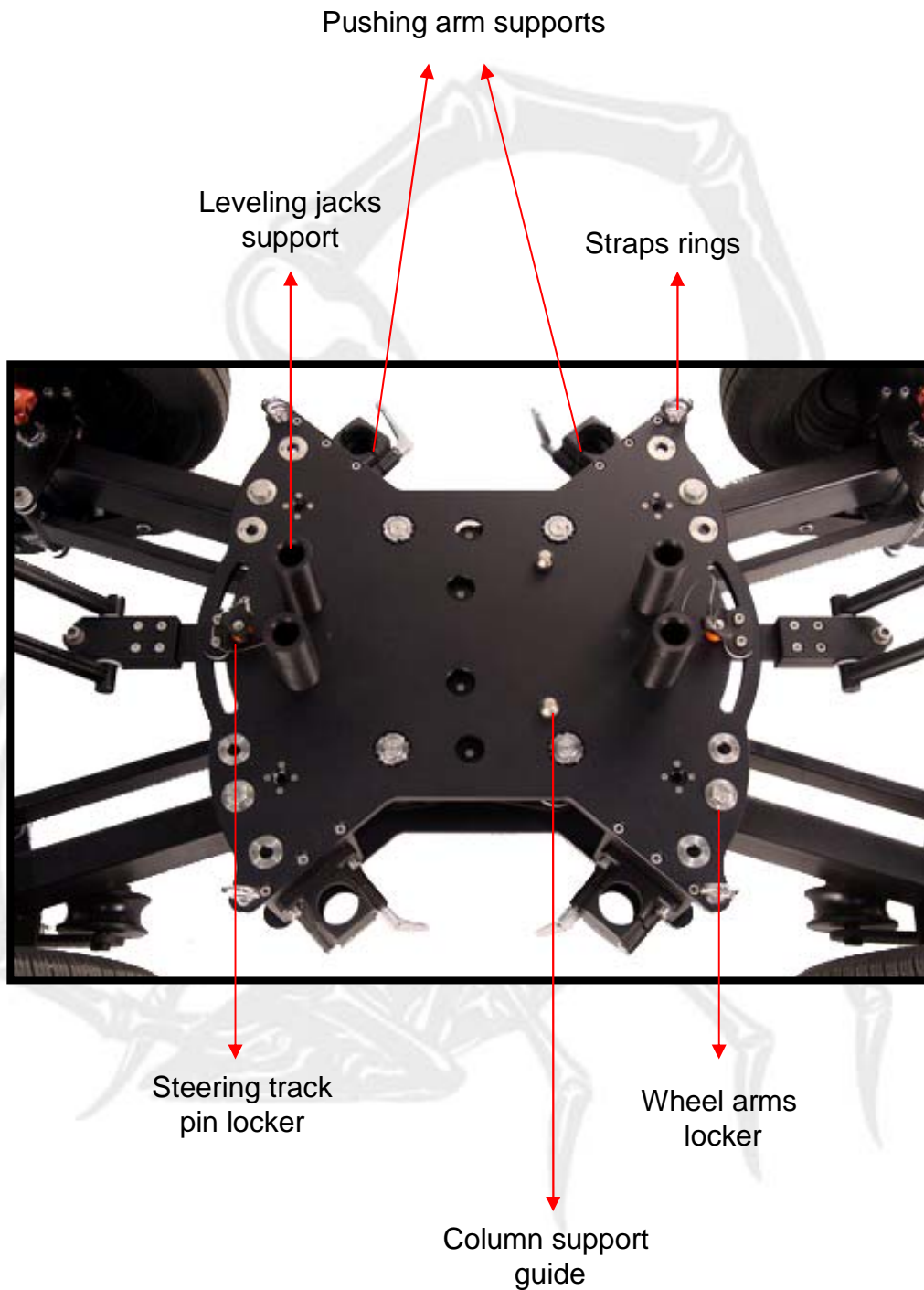

Three possibles dollie's configurations.

-62 cm. / 2 ft. track

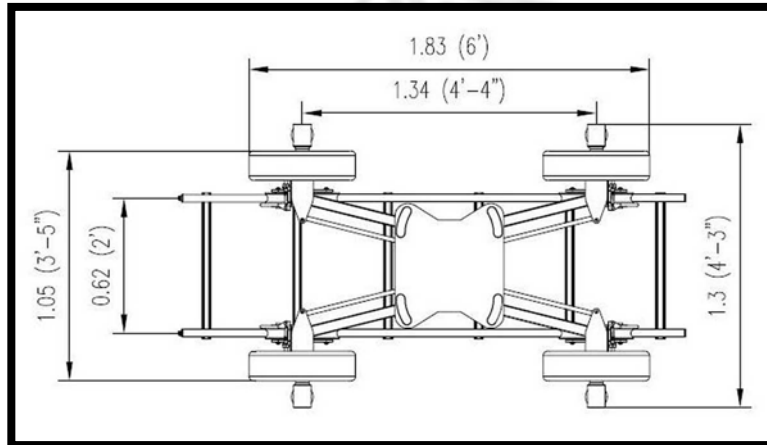

- 100 cm. / 3.3 ft. track

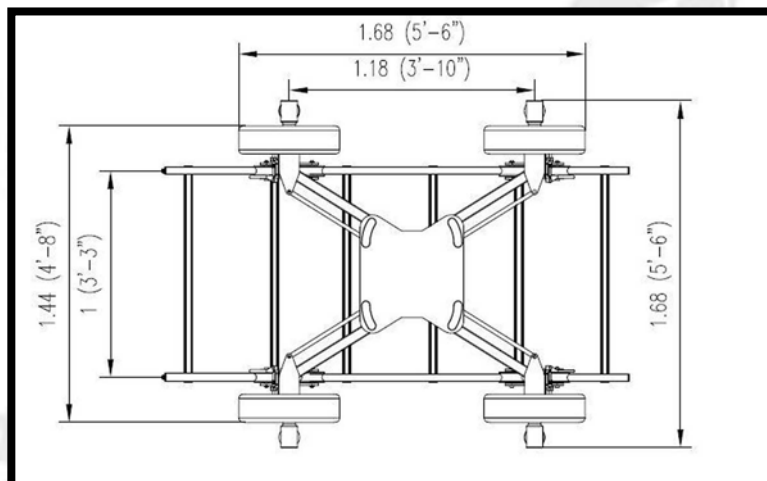

- Smaller position, only for go through a door.

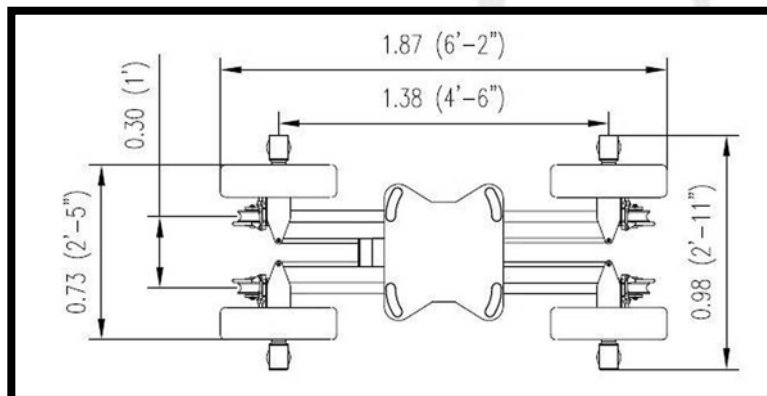

B1.1 Track wheels.

The SCORPIO 23' has quick put on/take off tracking wheels for tracking shots. These tracking wheels are designed to eliminate the memory effect.



The tracking wheels can be fixed on the dolly while transporting it, but we recommend removing and storing them when not in use.

To fix or remove the tracking wheels they are fastened to the bottom of the dolly, next to the pneumatic wheels, with a direction positioner and locking screw.

The tracking wheels must be mounted with their brake facing outwards.



You must keep that there are two kinds of track wheels. One of them can move the axial part, and the other one is fixed. This characteristic is used to adjust correctly the dolly with the tracks. It's important that the same kind has to be assembled at the same dolly's side.

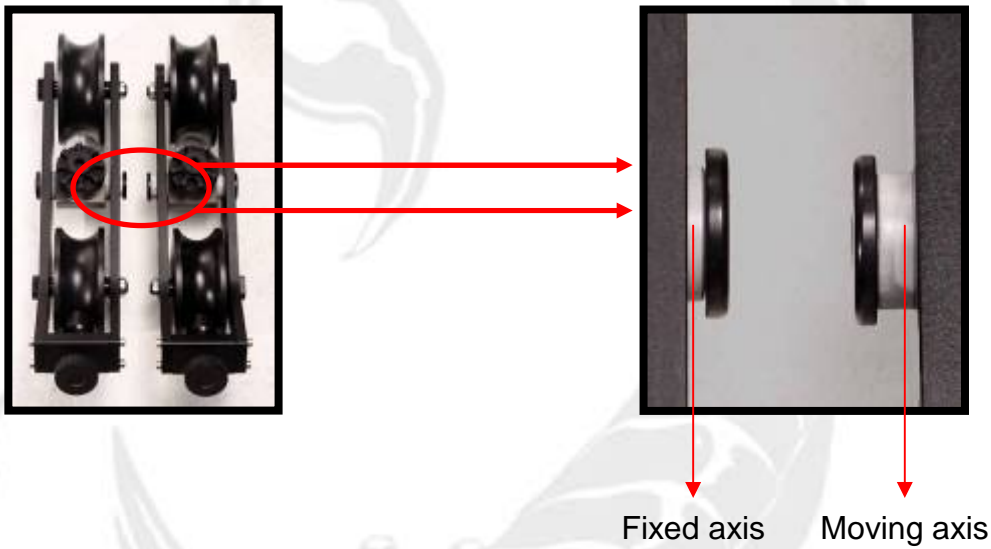

B1 Pneumatic Wheels.

The pneumatic wheels always have to be on the dolly. They are only allowed to be removed when the crane is on tracks.

Especifications:

- Inflated with air 2-2.5 bar.
- Ref. 145/80R10 69S

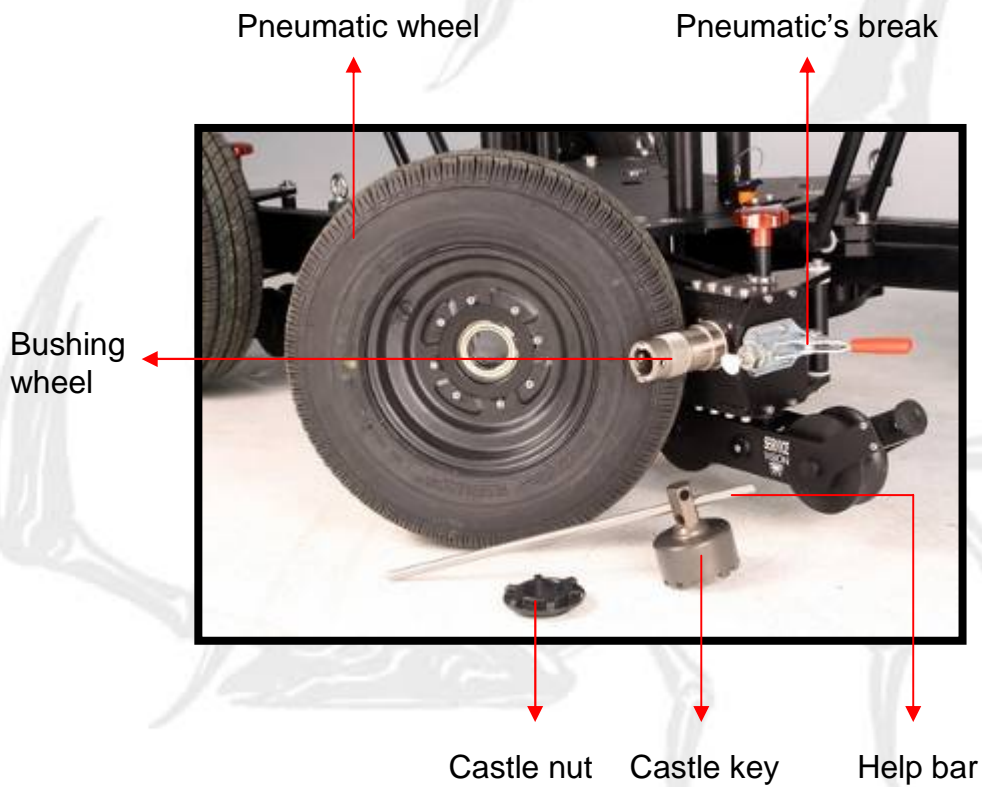

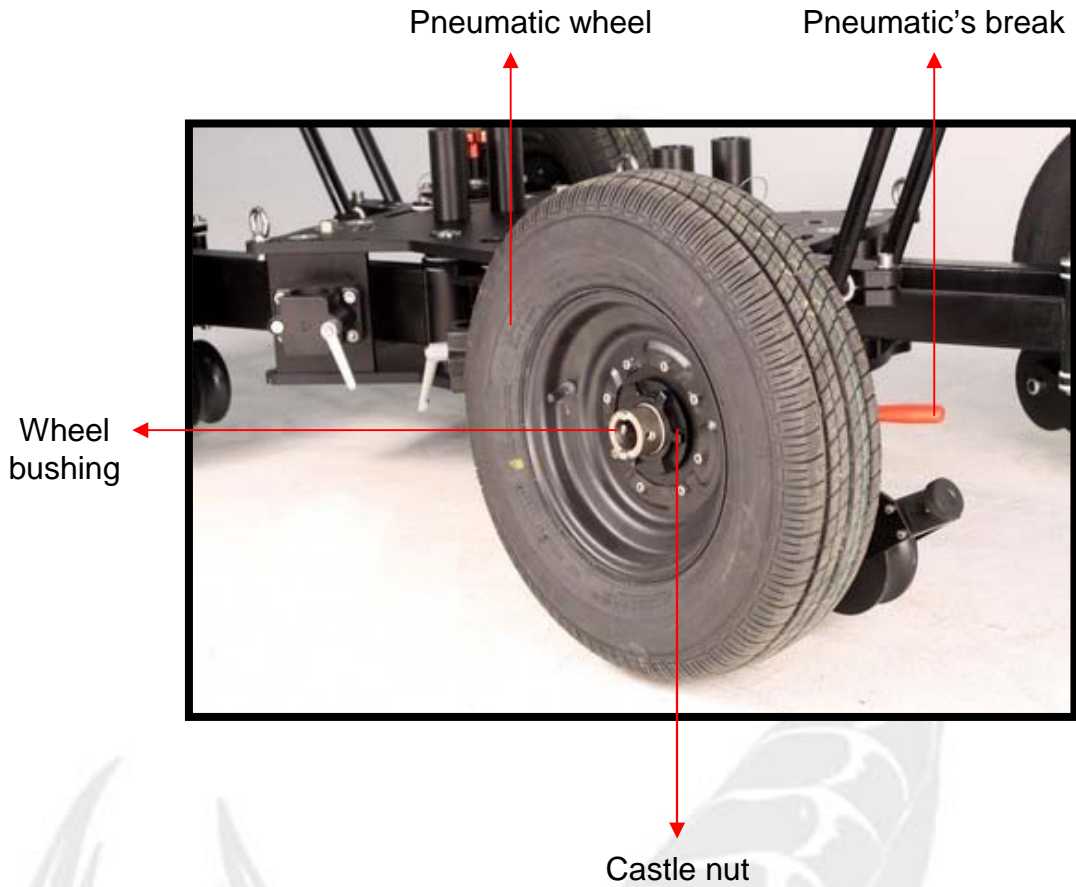

To remove the wheels they must be lifted from the ground with their respective levelling jack. The brake must be off. With the castle tool unscrew the nut that fixes the wheel to the dolly. Then with two hands remove the wheel from the wheel bushing.



To fix the wheel again, do the same operation fixing the castle nut with your hands only.

B1.3 Leveling jacks.

For transport and normal use of the crane without tracks, the levelling jacks must always be mounted on the dolly.

The levelling jacks have two locations: mounted on the outside of the pneumatic wheels or in their holders located on the dolly.



- Leveling's assembly.

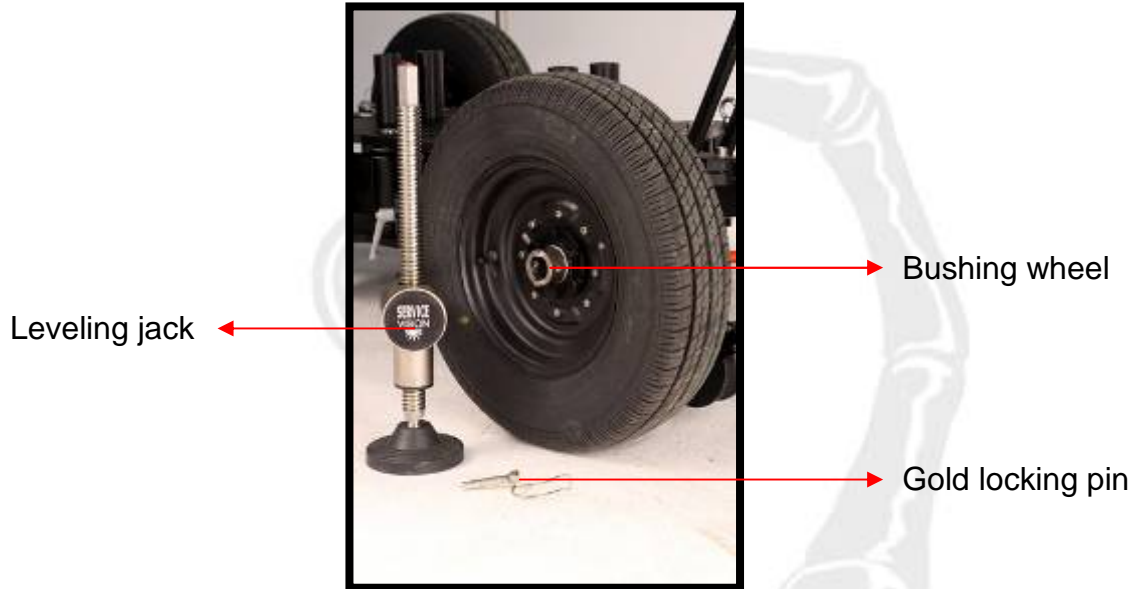

To fix them onto the wheels slide them into the tube that comes out of the wheel bushing and lock them in place with the gold locking pin. To do this operation the foot of the levelling jack must not touch the ground.

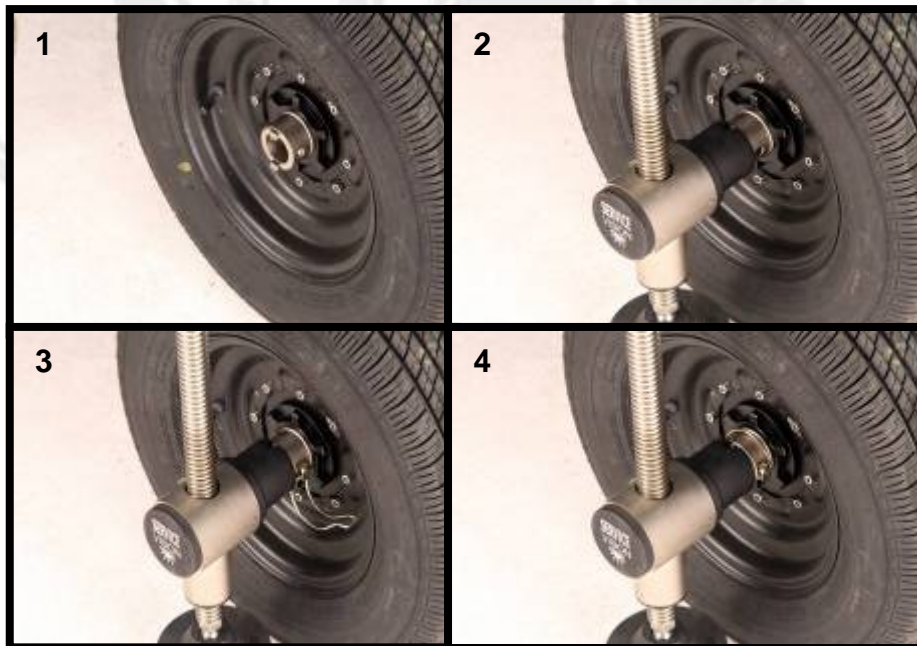

B1.4 Steering.

For transport and normal use the crane's steering handles must always be locked with the locking pins. Only remove the locking pin when you need to use the steering.

When you remove the locking pin, put it in its support on the dolly.

The dolly has two independent steering handles, one for each set of wheels, front and back.

It is possible to use them both independently or together if you need to make a tight corner.

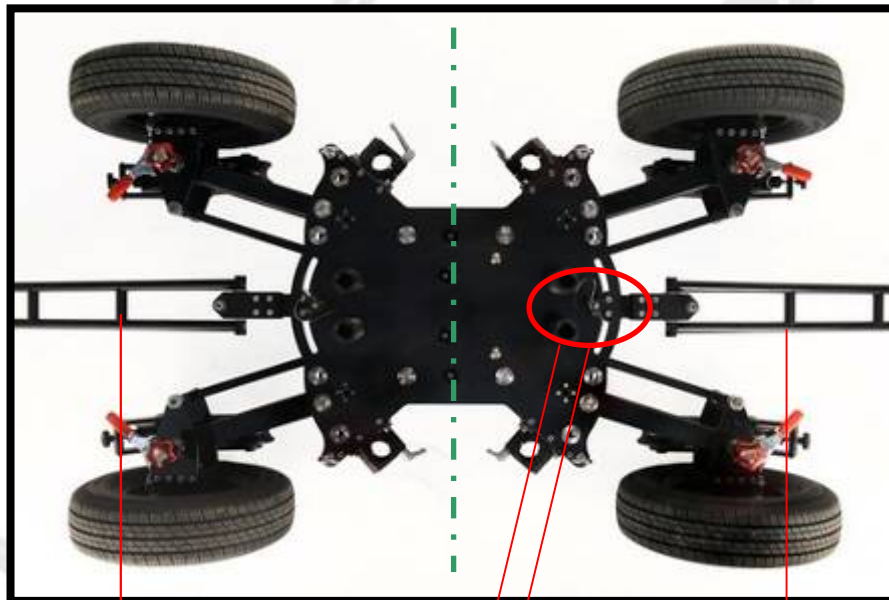

Steering handles

Steering handles



Steering
locking pin

B1.5 Push Bar Support

The push bar clamps are situated on both sides of the dolly. Standard 50 mm. tubes can be mounted to push the dolly on tracks.

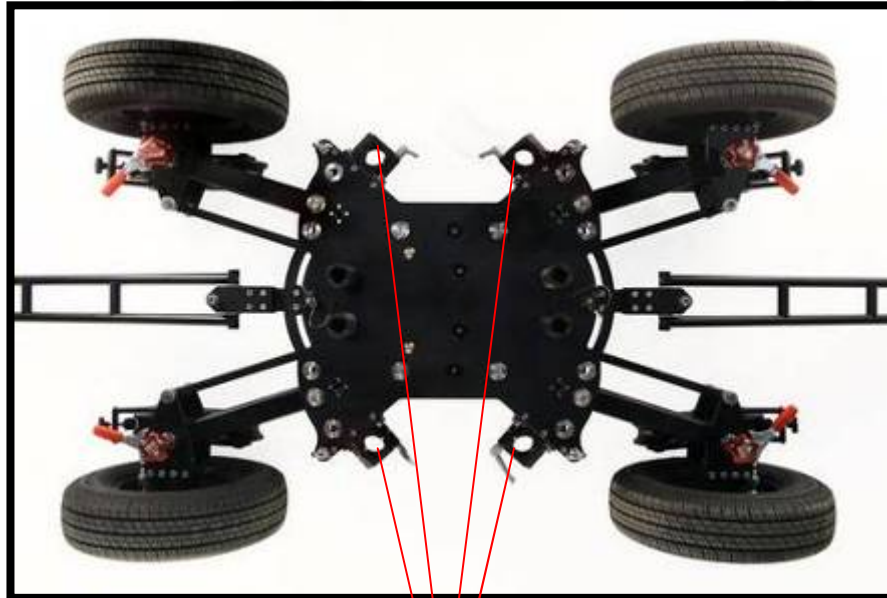

Push bar clamps



- Possible assembly.



B1.6 Wheel Arm Position

The SCORPIO 23' has three wheel arms positions. This allows us to use 62cm / 2 ft., and 1m. / 3.3 ft., tracks and allows us to pass through a standard 80cm. / 2.6 ft. doorway.

Option A is for 1m. / 3.3 ft. wide tracks and high speed movements. It is the widest and therefore makes the crane most stable.



The option B is for 62cm / 2 ft. wide tracks and normal speed movements.



The option C is the narrowest and is used to pass the crane through doorways. In this configuration it is forbidden to use the crane to shoot. The base is not stable enough to allow arm movement. The crane is top heavy and will topple over. The steering can only turn a few degrees in either direction because of the width of the wheel arms.

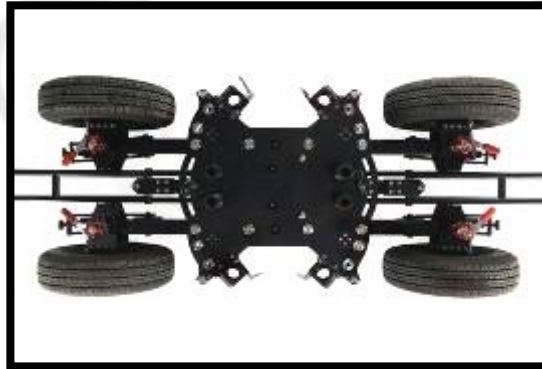

All three configurations can be used for transportation.

- How to change the position.

Fasten the crane arm with it's straps to change the configuration of the wheel arms. It is not necessary to remove the counterweights.

The four levelling jacks have to be mounted on the wheels.

Lift the dolly with all the levelling jacks except the respective wheel's until you can move the respective wheel's arm. Be careful as the crane is slightly unstable during the operation.



Remove the screw that holds the wheel arm in place with the 24mm ratchet spanner.



Using your hands move the wheel arm to the new position and fix the screw back in place.



Lower the levelling jacks until the wheel touches the ground. Repeats the same operation with the three other wheel arms.

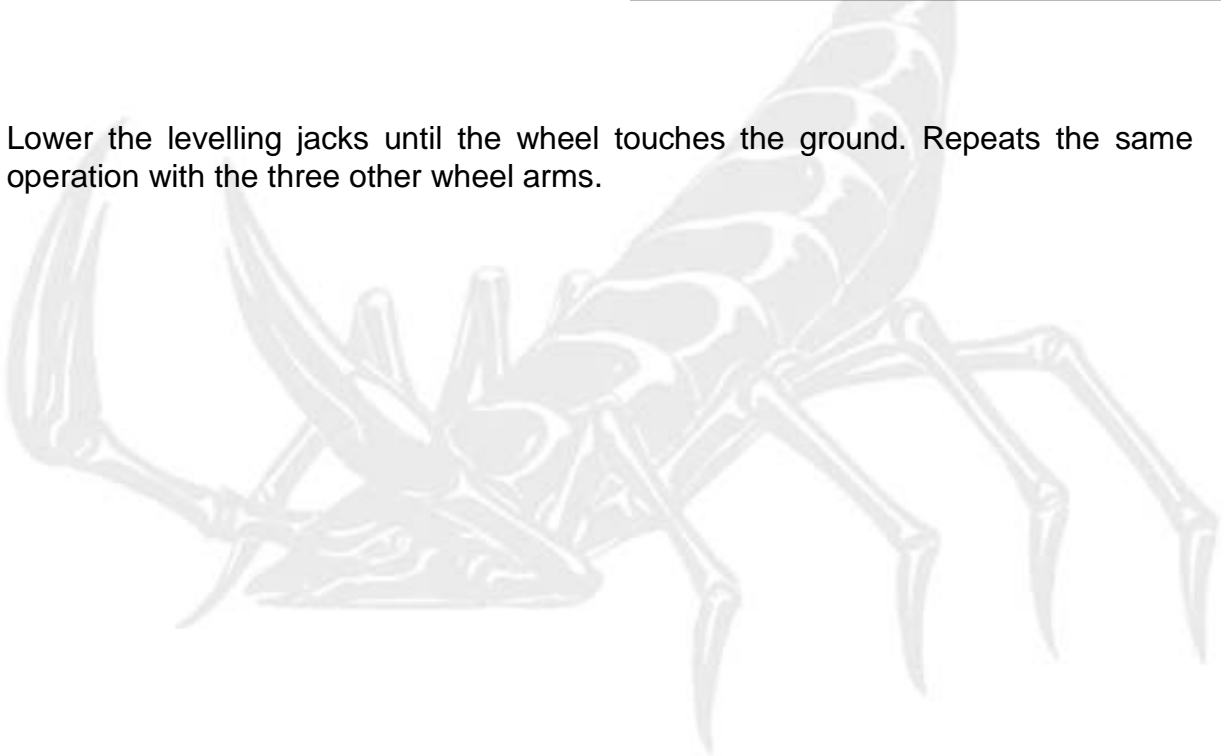

B2-. Telescopic column.

The SCORPIO 23'arm is supported by a 90 cm / 3ft. high column. This column is made up of a main column with a telescopic section inside it. It can be raised 40cm / 1.3ft.. This can be done with a 1kW. drilling machine.

The column has a flat base. It can therefore be fixed to any properly designed structure on a camera car etc.

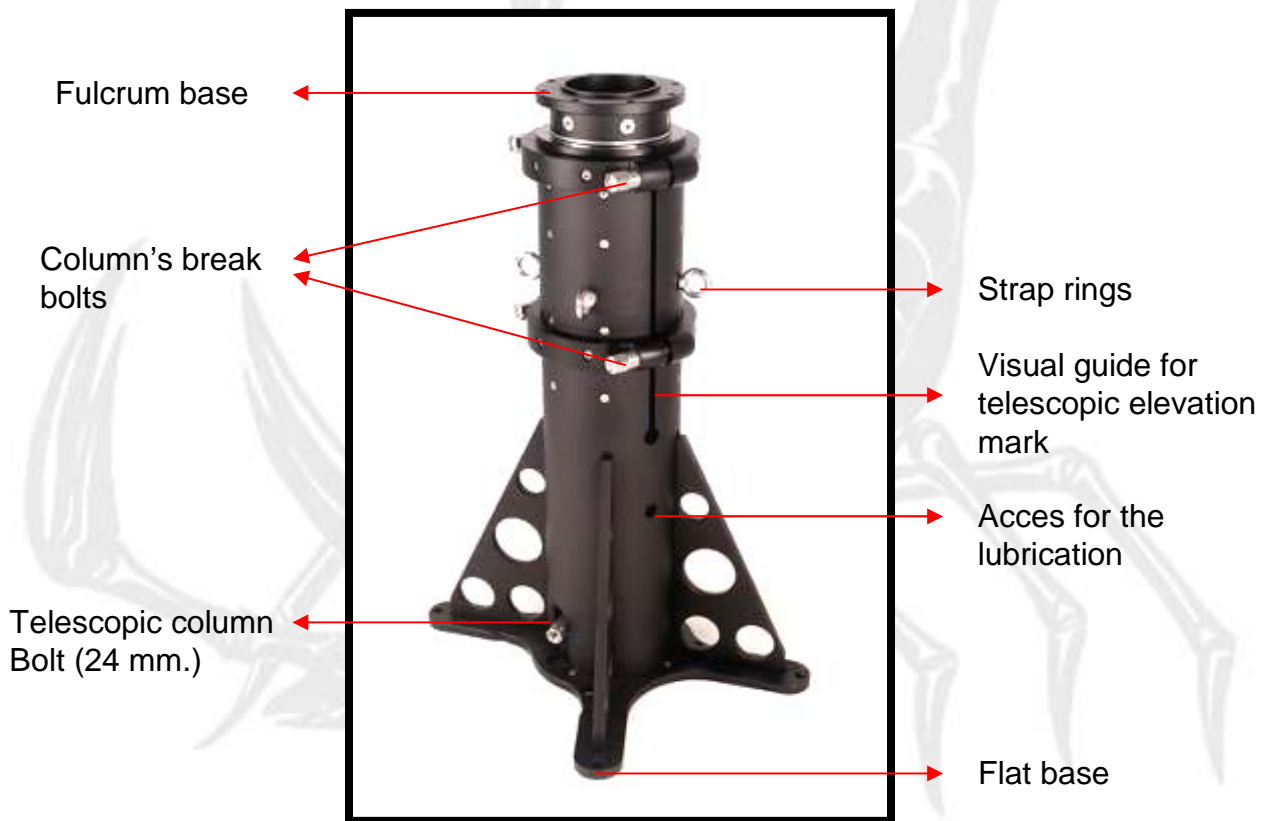

Column's sketch:

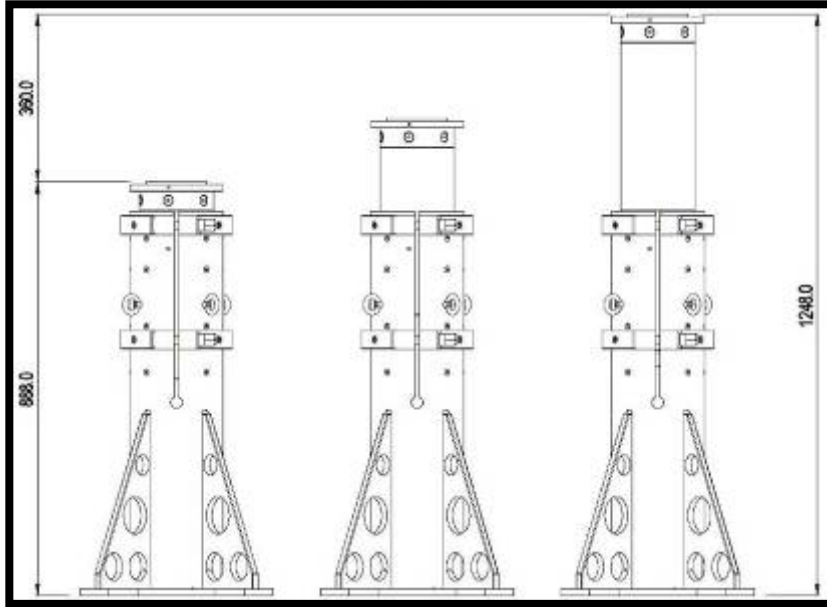

Hole support
guide

B2.1 Process to telescope the Column

To elevate the column the arm can be loaded or unloaded.
Remove the arm straps, fix the pan and tilt brakes and loosen the four column bolts.

Telescopic column
bolt ←



At the bottom of the base there is a 24mm nut which is mechanically linked to the telescopic column. Use it to raise and lower the column.

It is possible to use the ratchet spanner provided or an electrical drilling machine (1kW.) with the adaptor provided.



Use the two guide lines marked on the telescopic column to know where the maximum and minimum heights are.



Visual guide
mark

When you have finished tighten the four column bolts again.

B3-. Fulcrum.

The SCORPIO 23' s arm is supported on the Column by the Fulcrum.

A Panoramic or Tilt motion is made via the Fulcrum. The Pan and Tilt brakes are situated on the Fulcrum.

The arms of the Fulcrum are of different widths so that the correct mounting position of the Crane Arm is evident.

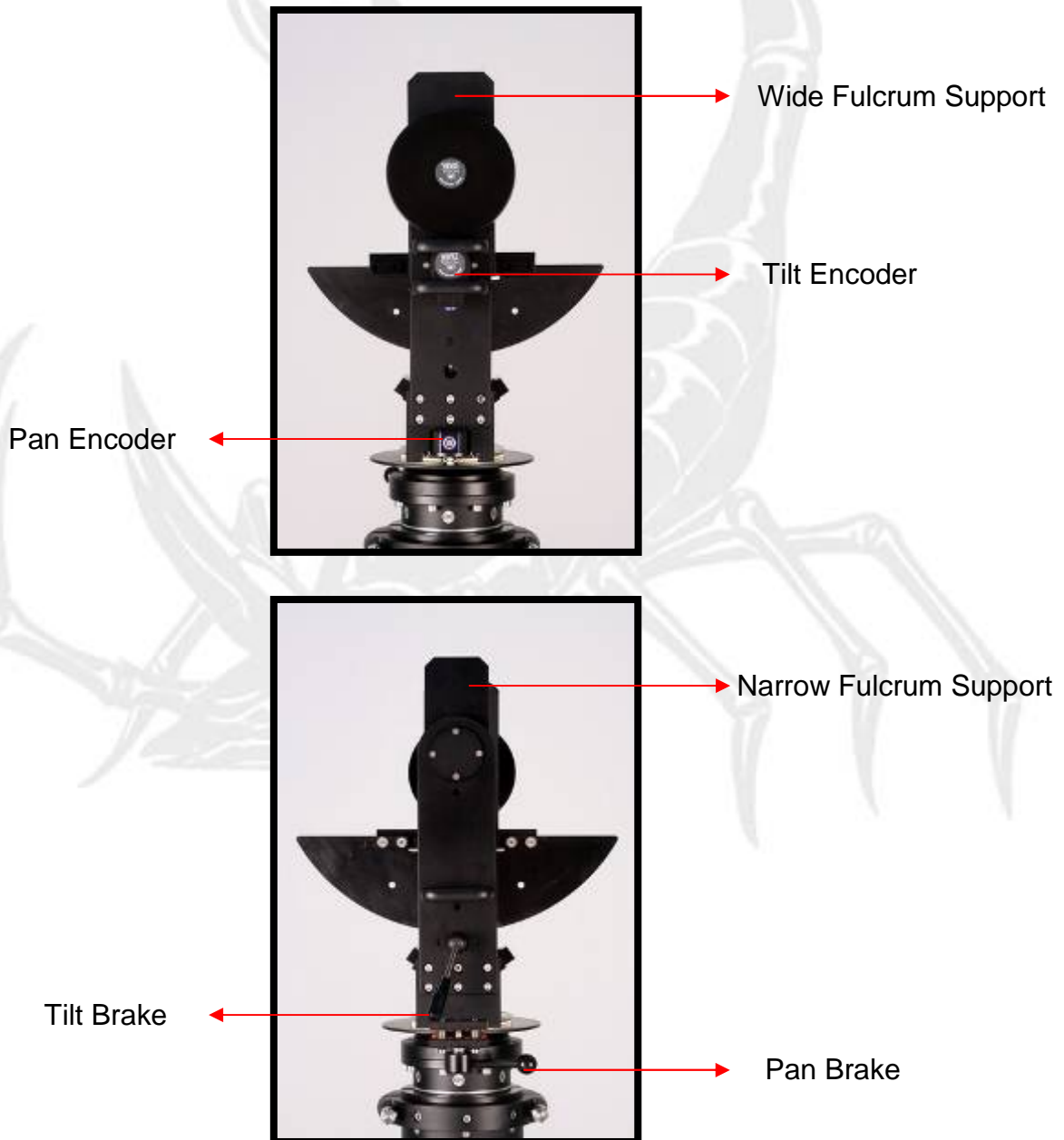

Both the Pan and Tilt angles are measured by an encoder which is connected via a belt to the Crane Arm. The encoders send information to the Electronic Box.

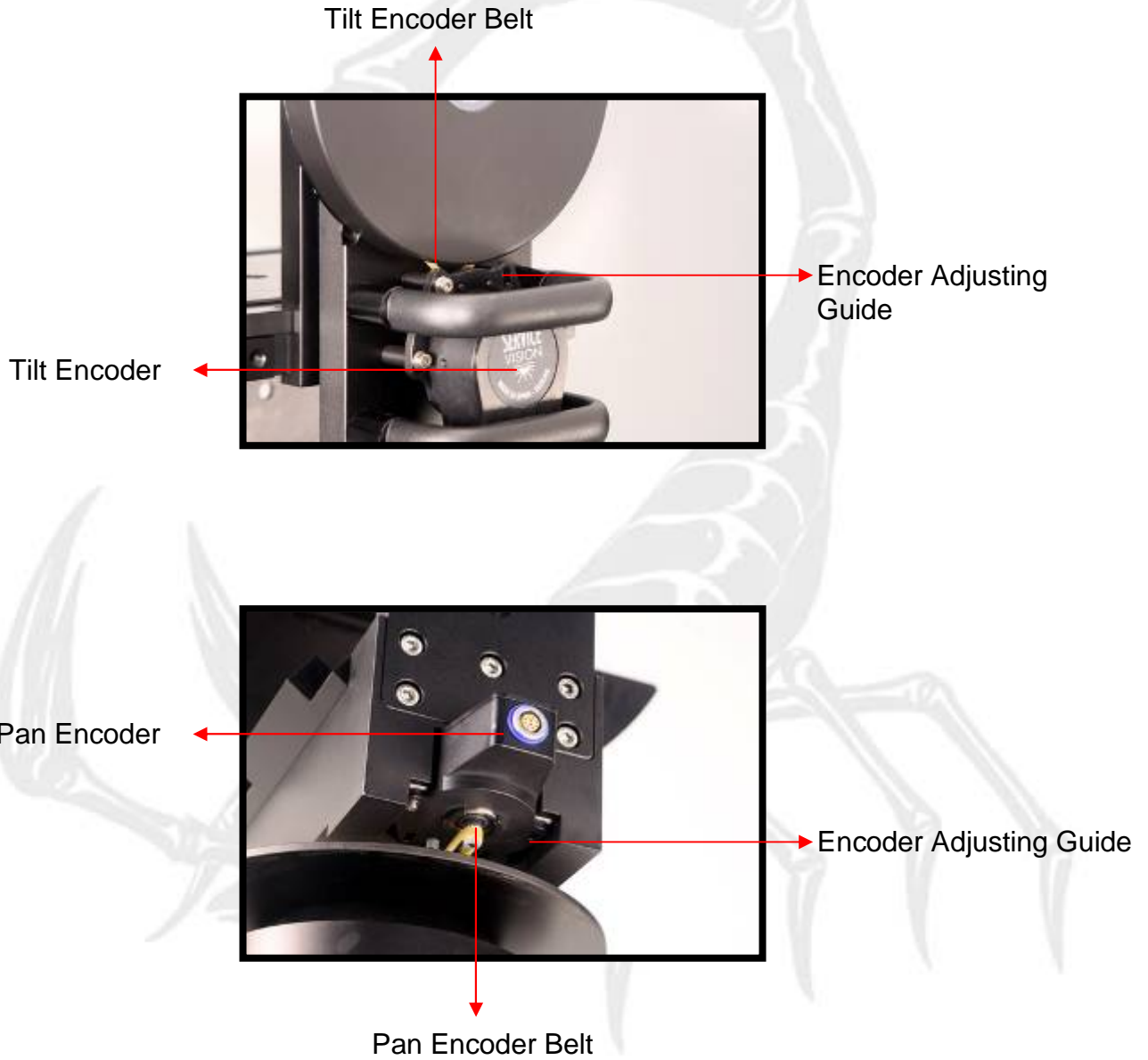

The Fulcrum has a flat base which enables it to be mounted on it's Column or any other suitable support.

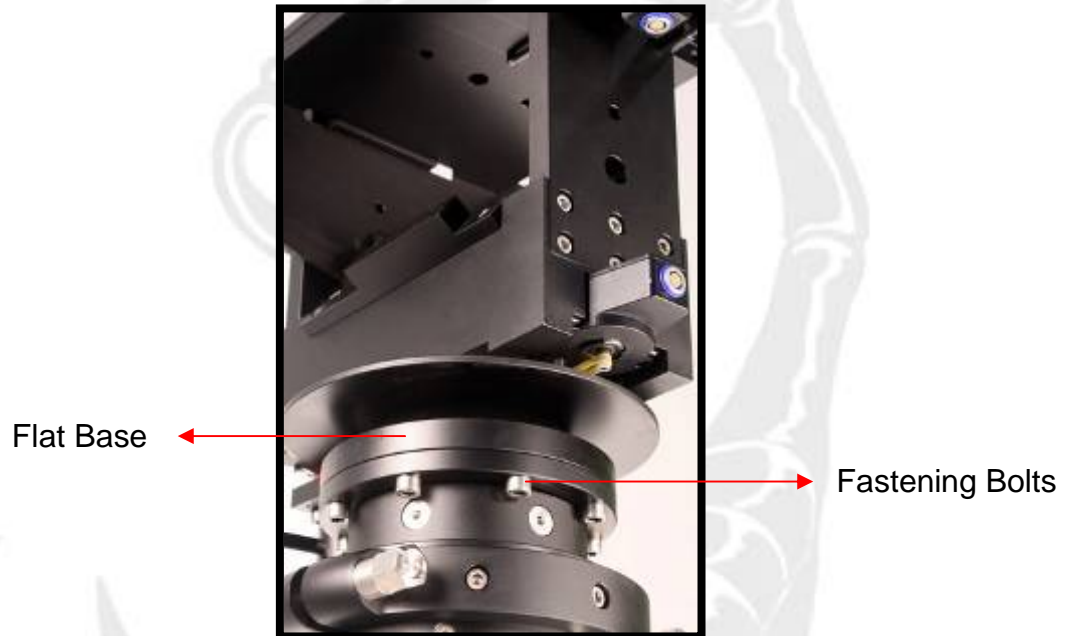

B4-. The Crane Arm

The arm of the SCORPIO 23' is made up of a main, fixed, tube and three telescopic tubes. These tubes enable you to move the camera from 1,5 / 4.9 ft. meters to 7,4 m. / 24.3 ft.

Other components of the crane arm are the counter weight carriage, the levelling head and the electronic box which controls the system.

The arm must always be strapped to the base via the adjustable ratchet straps when the crane is not working.

The ratchet straps can only be removed once the crane arm is completely balanced.

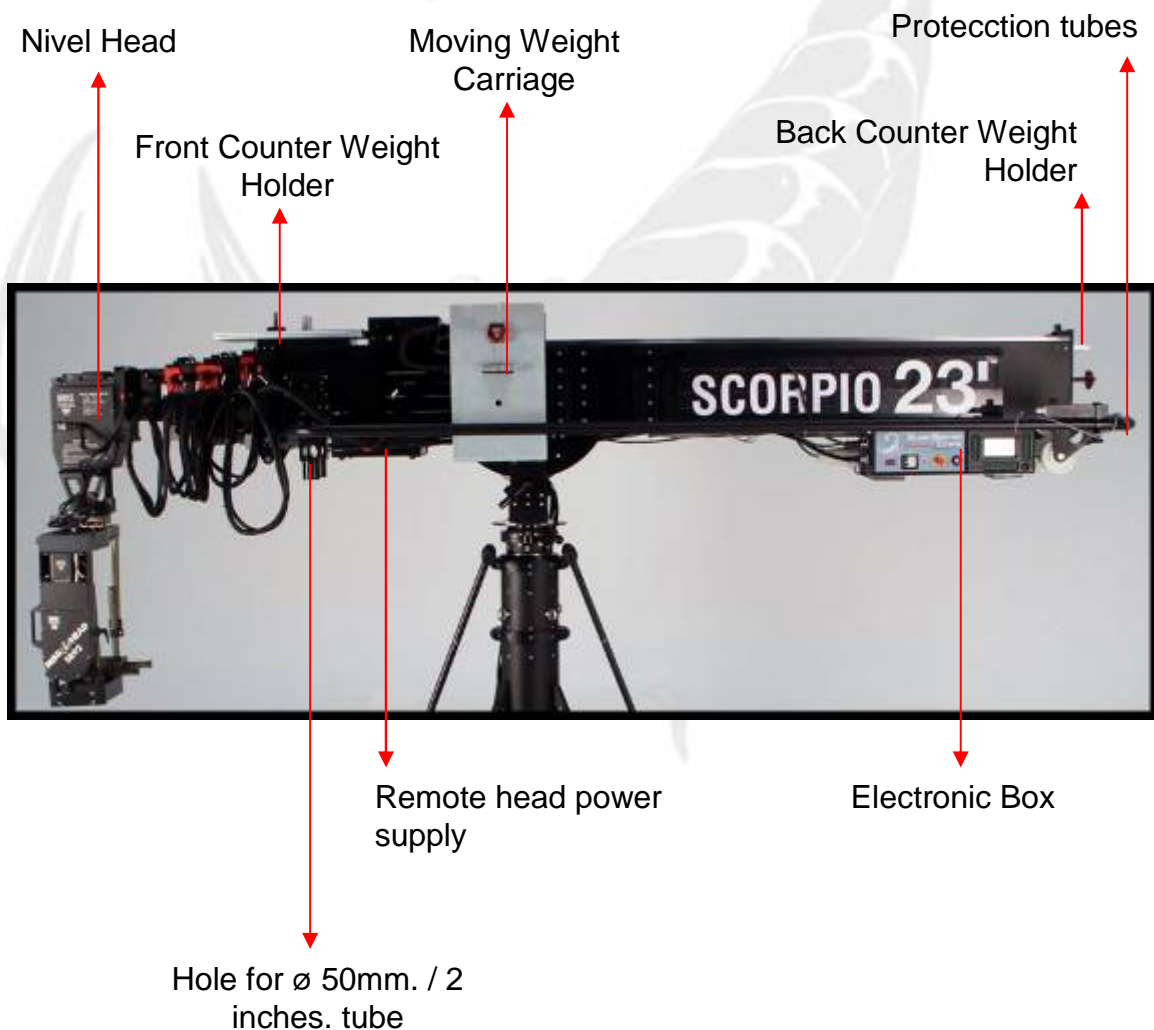

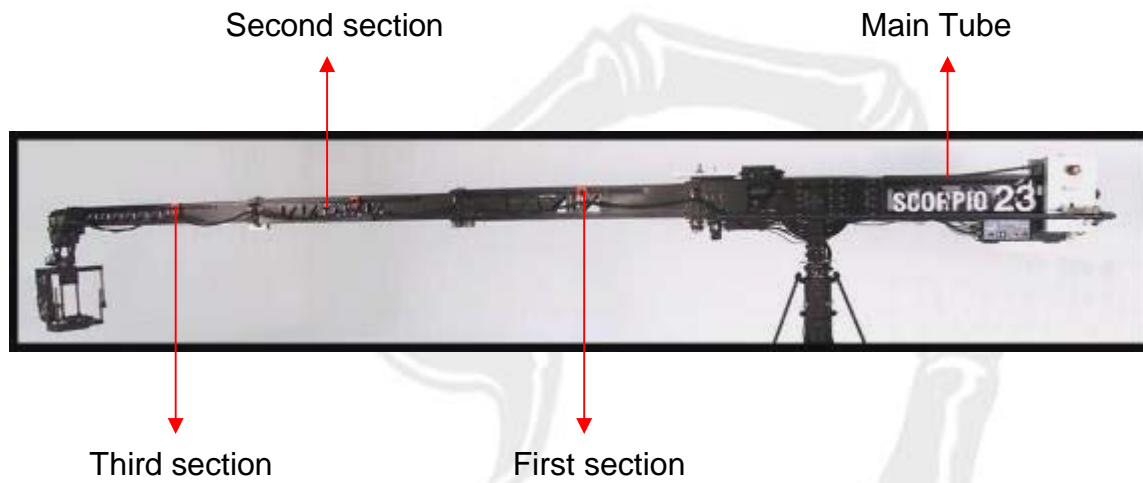

B4.1 The tubes

B4.1.1 The Main Tube

There are two plastic guide beams situated underneath the rear and front end of the main tube. The former are supports for the electronic box and the latter are supports for the remote head power supply.



Remote head power supply



Electronic Box



Underneath the front end of the main tube there are also two horizontal holes. These, with a 50mm round bar put through them, can be used to lift the crane arm when mounting and dismounting it from the fulcrum. This bar with the two wheels at the back end of the Crane Arm enable us to move the Crane Arm while out of it's support with ease.

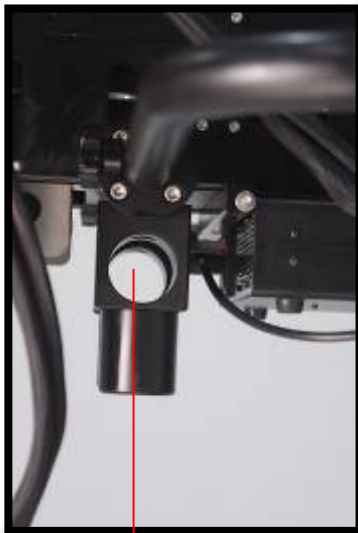

Hole for \varnothing 50mm. / 2 inches. tube

Tube \varnothing 50mm. / 2 inches.

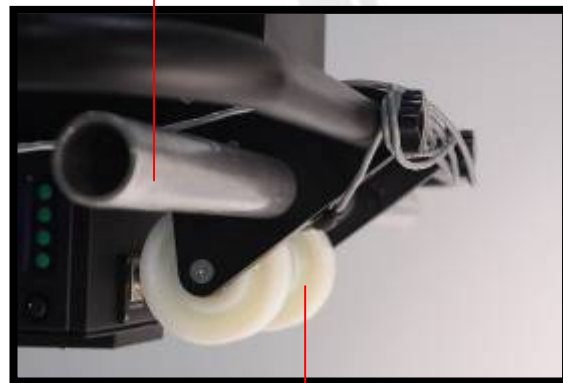

Back end wheels

There are weight holders on the back and front top end of the main tube which are used for counter balancing the crane.

Back weight holder

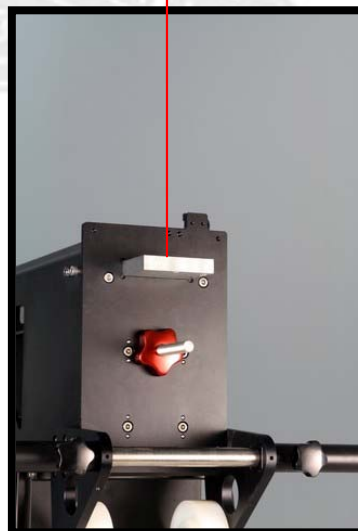

Front weight holder

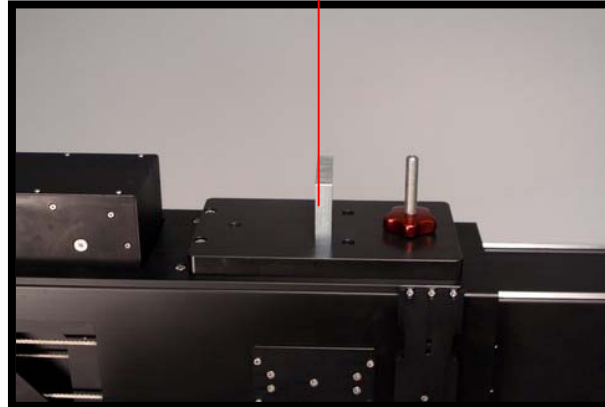

The Moving Weight Carriage is on the top centre part of the main tube. This is also used for counter balancing the crane.

B4.1.1.1 Crane Arm Fixation Guides

The crane arm is held onto the fulcrum by two clamping guides which are in the centre of the crane arm.. The clamps have a sliding piece with two screws which are used to clamp the guide between them. These screws must always be tight while the crane arm is on the fulcrum.

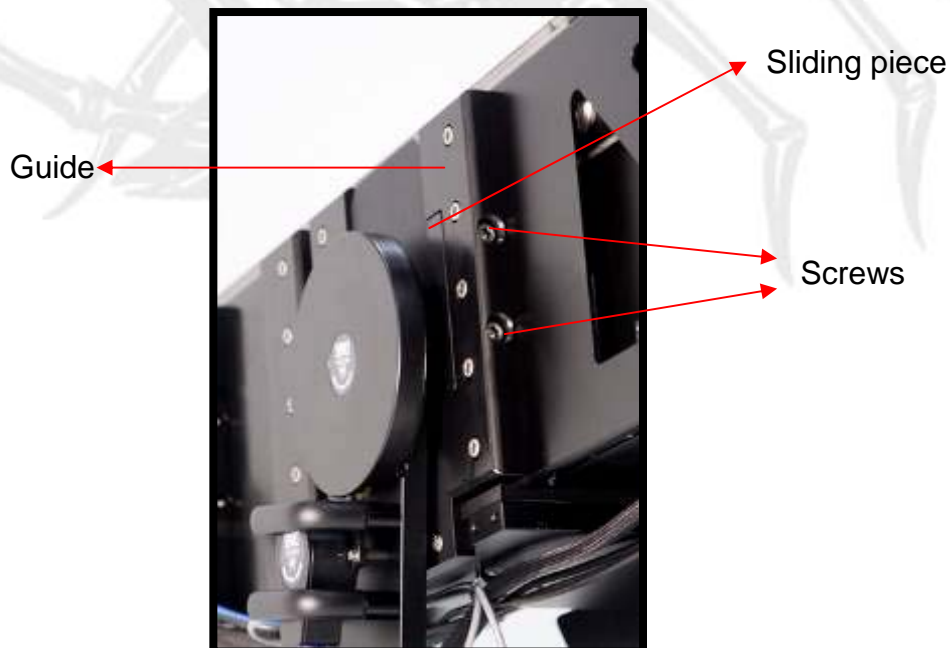

The guides that fit into the clamps and their respective clamps are of different widths so that a mistake can not be made while mounting the crane arm.

Wide Fulcrum Support

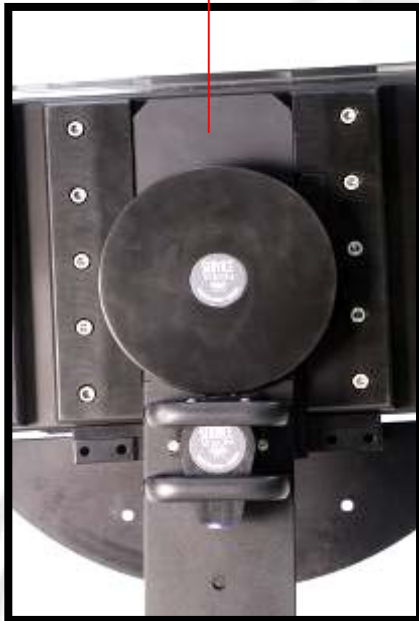

Narrow Fulcrum Support

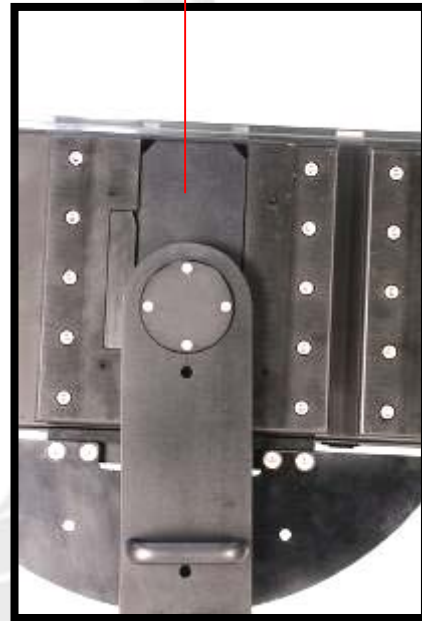

The positioning guides that connect the Crane Arm to the fulcrum have been positioned so that the weight distribution is correct for the tilt axis. Therefore it is prohibited to put anything between the Crane Arm and the Fulcrum.

When remounting the Crane Arm on the fulcrum make sure that there is nothing in between them. This would cause the weight distribution to be totally out of balance and the crane would never be able to be balanced correctly. For this reason is forbidden to put anything between their arm and the fulcrum.

B4.1.1.2 Protection Bars

On each side of the central tube there are two fixation pins. These are used for fixing the Protection Bars to the Crane Arm with two locking screws.

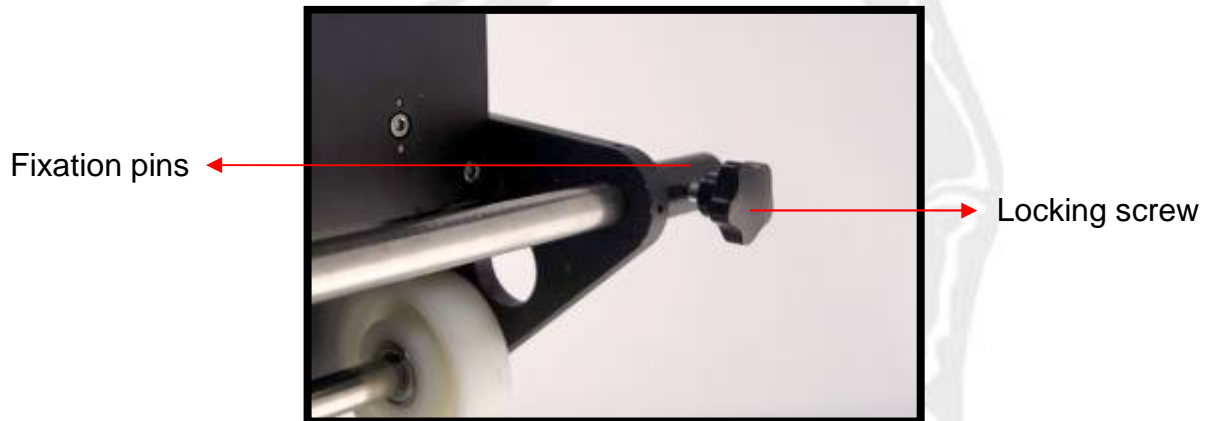

These Protection Bars mark out the area in which the Counter Weight Carriage moves and therefore must never be removed while the crane is working. The operator never could be between the arm and the protection bars.

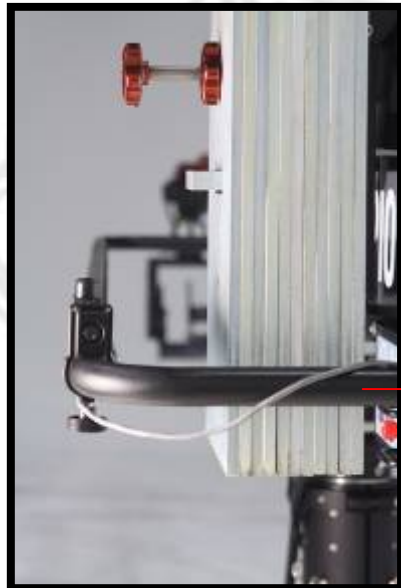

Protector bar

They are also used to hold and move the Crane Arm, hold the hand unit, hold the monitor support and hold the Sliding Weight.

B4.1.2 Telescopic Tubes

The Crane Arm is made up of three Telescopic Tubes which have a cable system between them. Each tube has a system of guides and guide wheels on the top and bottom.

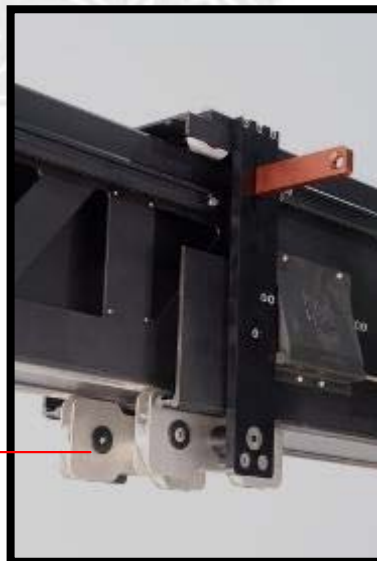

Bottom Guide wheels

Top Guide wheels

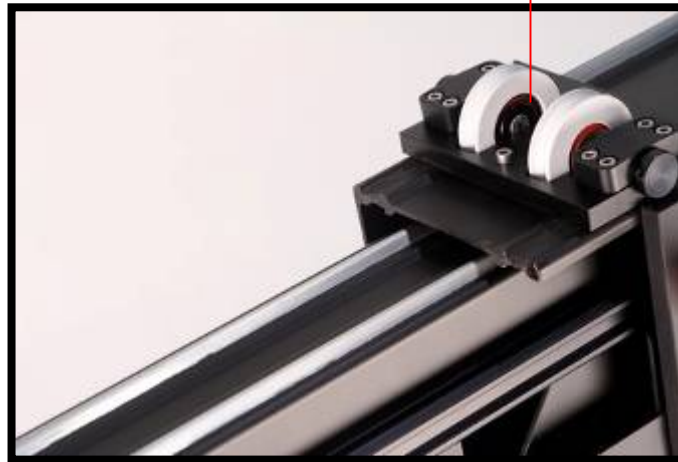

With the correct adjustment of the guide wheels on the top we can reduce the vibration transmission to the end of the crane and therefore the camera and lens.

The Crane Arm is moved with a double cable system within each tube. This system with a cable on each side of each tube ensures that the tubes move in a completely straight line.

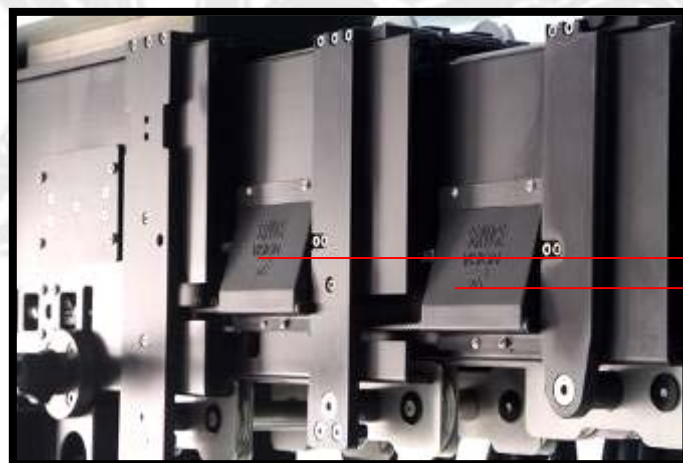

In/Out cable

This system of short cables within each tube means less maintenance as there is much less cable stretch.

B4.1.2.1 Hanging the Cable Looms

The Telescopic Tubes have a fixed and a moving cable support which run down the side of the Crane Arm.

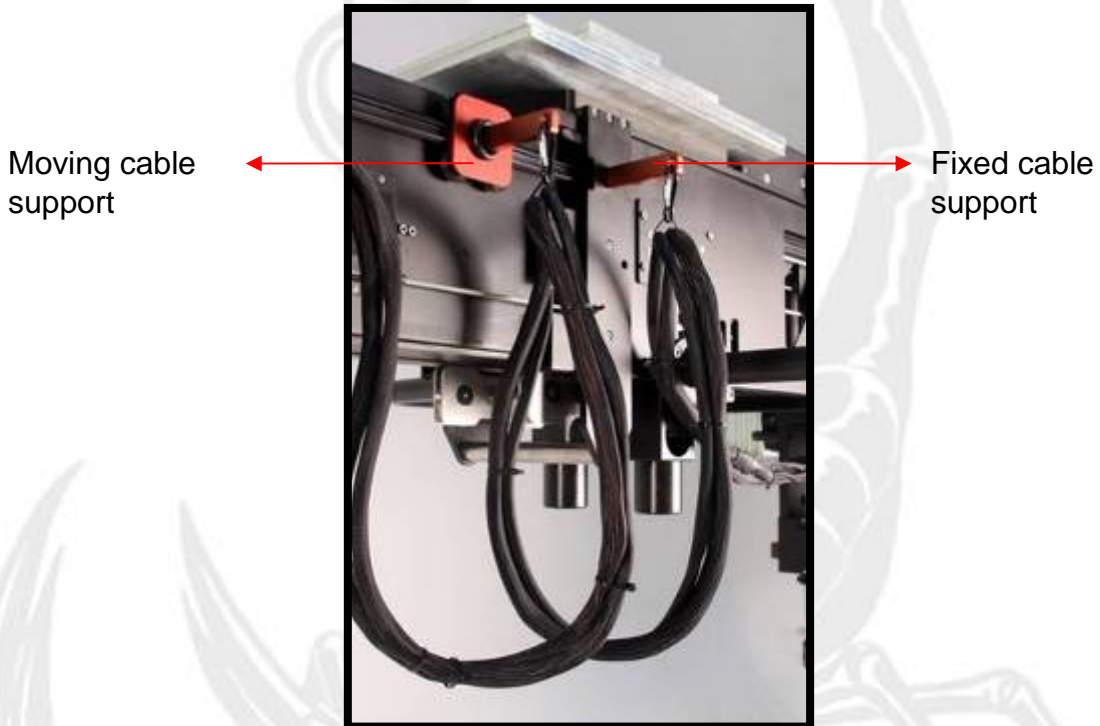

The moving cable supports must all have a rubber ring around them to stop the noise generated when they bump into the Telescopic Tube when the tubes move in and out.

Each of the cable supports has a karabiner. This allows you to take off and put on the cable looms without tools and without having to break up the cable looms each time.

To hang the cable looms the Crane Arm must be at its maximum length. To be sure of this the crane is switched off/on and then the back/max length limit is made. Then, the moving cable supports are put into the middle of their respective tubes.

Moving cable support

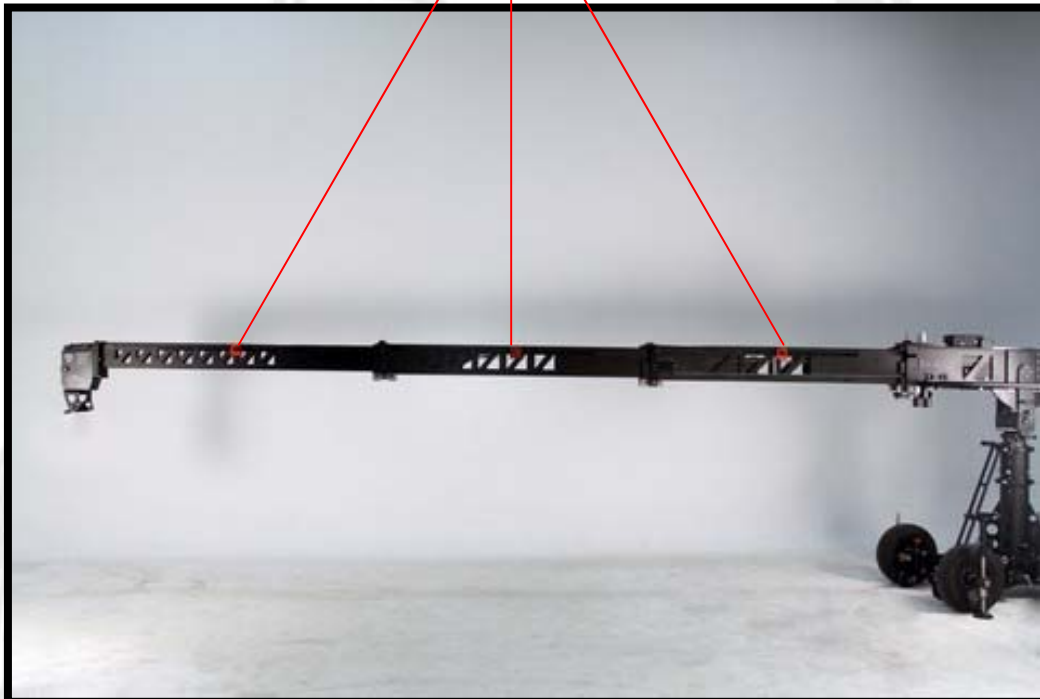

The remote and levelling head looms are connected. Moving from the levelling head to the Crane Base the looms are held in the air and a mark, with tape, is made at each cable fixation point.



Once all the corresponding marks have been made the two looms are rolled up.

Now a cable tie is put on each tape mark. This cable tie is attached to the Karabiner as the cable is then unwound from the Leveling Head until the Crane Base.



It is important that the Cable Loom is made in loops so that when the Crane Arm is closed the cable hangs correctly.

Once the Cable Loom has been hung it has to be checked throughout the whole movement of the arm so see if there is any risk of it being cut.



B4.2 Counter Weight Holders

The Scorpio 23' has four Counter Weight Holders. Two are fixed and they are called the front and back Counter Weight Holders. The next is manually movable and is called the Sliding Weight. Lastly we have the Moving Weight Carriage which balances the telescopic arm as it moves in and out.

B4.2.1 Front and Back Counter Weight Holders

The Back Counter Weight Holder is situated at the back of the main tube of the Crane Arm. It consists of a screw and a red locking nut that are used to fasten the original counter weights. It is recommendable to put on small to medium size weight as to not have the weights sticking out above the main tube.

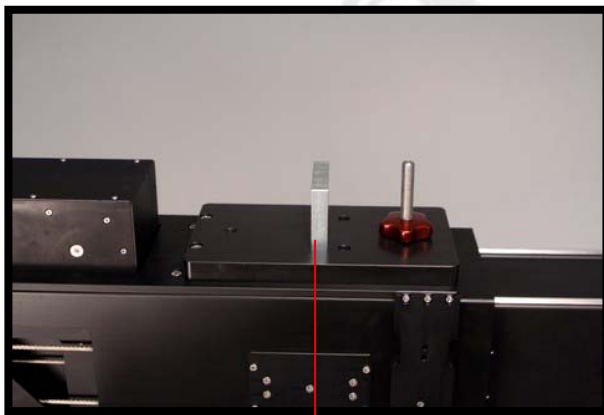

Front Counter
Weight Holder

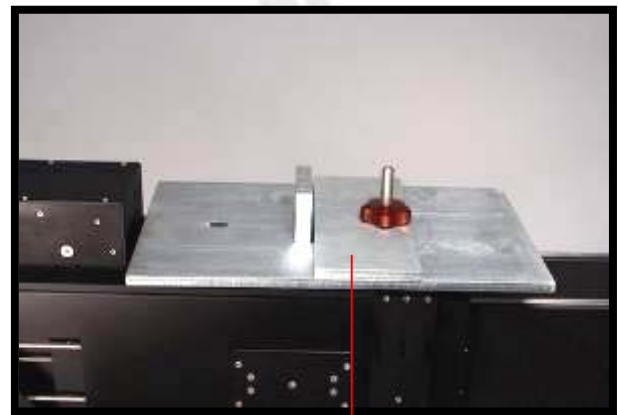

Counter Weight

This weight holder is used when the crane is front heavy.

The Front Counter Weight holder is situated at the top front part of the main tube. It consists of a screw, a red locking nut and a platform that are used to hold in place and fasten the counter weights. Here, all original weight sizes can be used with out having any size problems. This weight holder is used when the crane is back heavy.

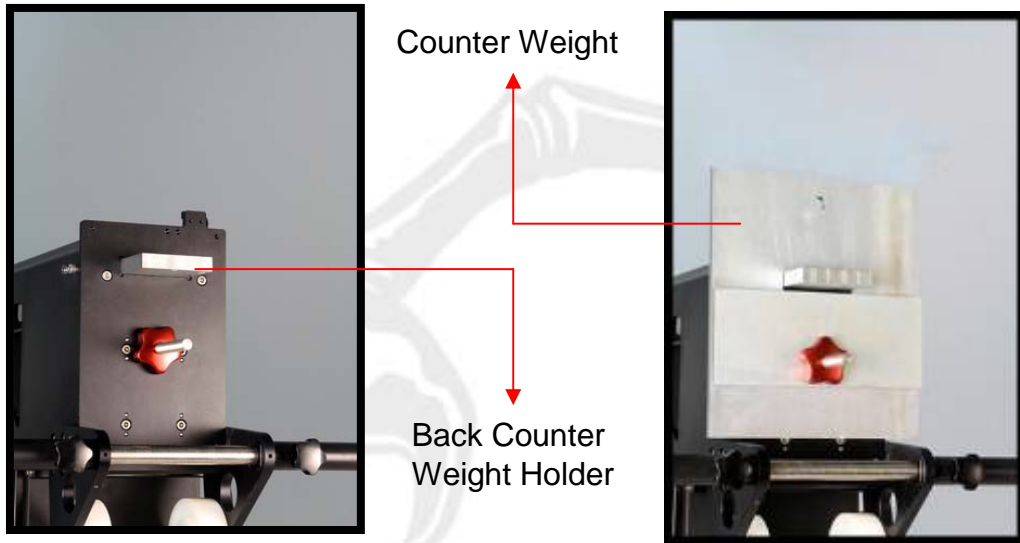

B4.2.2 The Sliding Weight

The Sliding Weight is a five kilogram cylindrical weight that is put on the Protection Bar of the main tube. It has a lock off screw that can be loosened to be able to move the weight comfortably along the Protection Bar.



B4.2.3 The Moving Weight Carriage

This weight holder is the one that counter balances the telescopic crane arm while it's moving. It consists of an inverted metallic "U" that is connected to the moving carriage on the Crane Arm. The U is fixed to the carriage with two metric 20 hexagonal bolts. It has two "male" positioners, on each of its sides, which fit into the "female" weights.

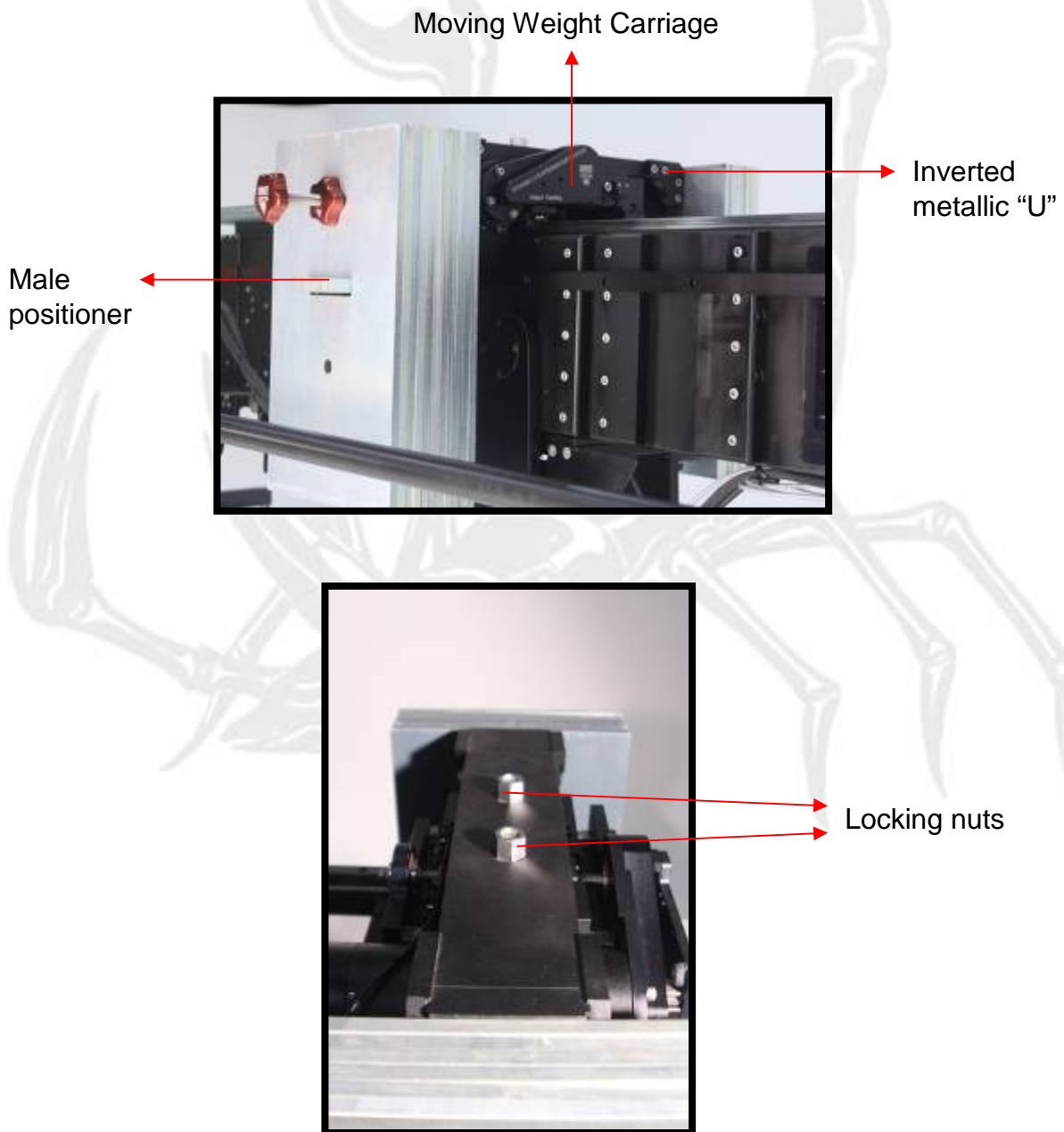

The counter weights are fastened onto the weight carriage by to screws. These screws have a intermediate locking nut to be able tighten different amounts of weights easily. These screws have two locking positions. One on the top and one on the bottom part of the “U”. The top locking position is recommended for safety reasons.

The crane is never used without the Weight Fastening Screws securely fastened.

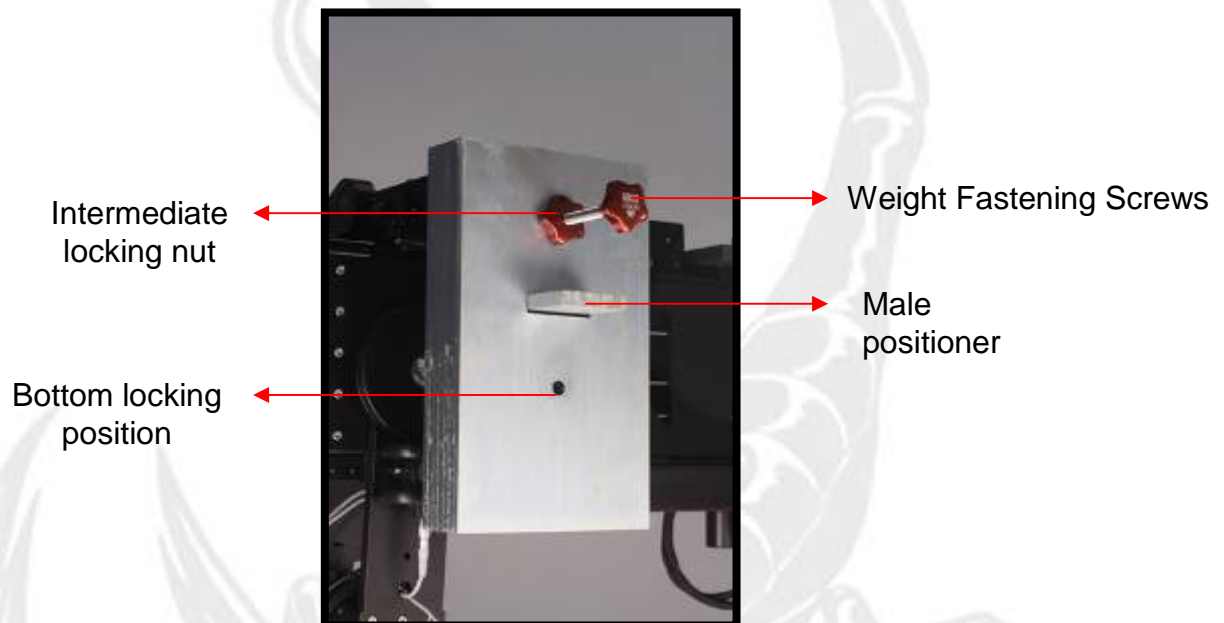

The maximum number of weights can be told be the length of the male positioner on the “U”. This maximum amount can never be passed.

B4.2.4 The Counter Weights

The Scorpio 23' has the following weights:

- 26- 15 kg./ 33 lbs. counter weights
- 1 - 12 kg. / 26.5 lbs. counter weights
- 3 - 7,5 kg. / 16.5 lbs. counter weights
- 2 - 3,7 kg. / 8.2 lbs. counter weights
- 2 - 1,85 kg. / 4.1 lbs. counter weights
- 2- 1 kg. / 2.2 lbs. counter weights

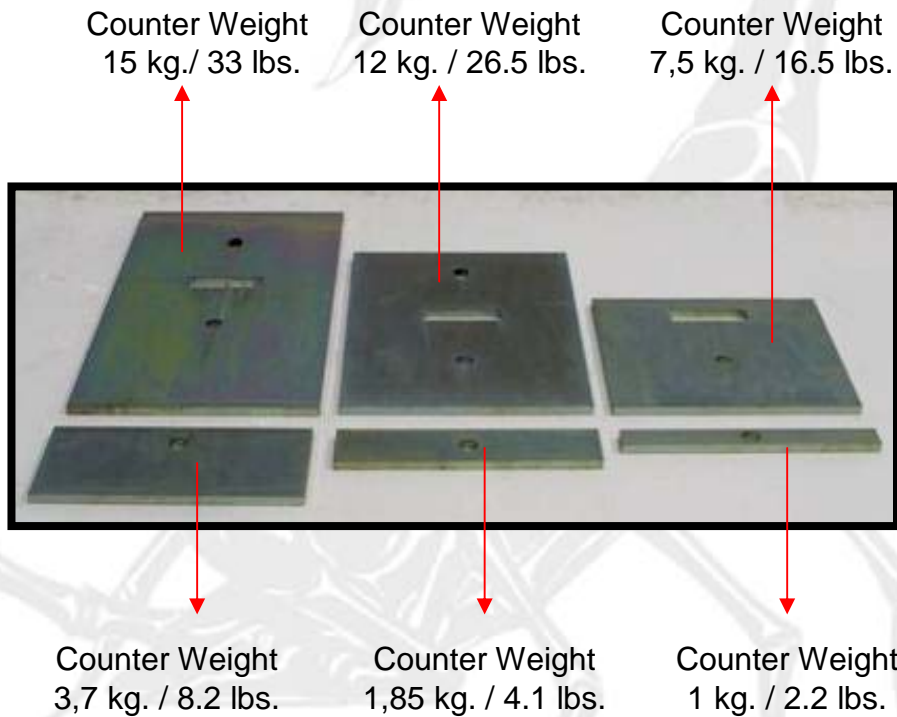

All the counter weights fit into three weight trolleys for your convenience.

The crane is never used without the Weight Fastening Screws securely fastened.

- Fix cable's assembly.

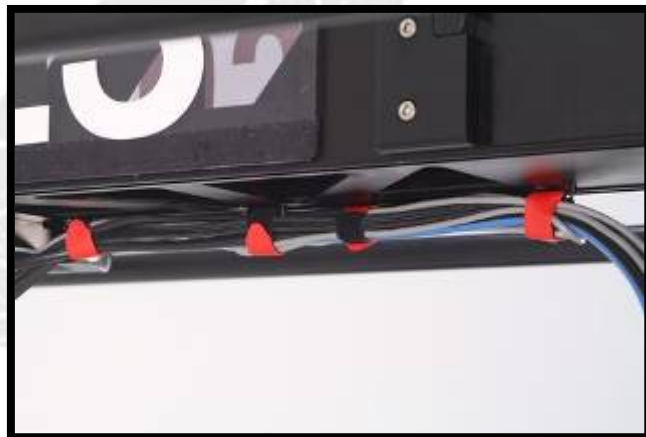

B4.2.5 Balancing the crane

To balance the crane there are two steps. Step one is to balance the static part of the crane, ie as if it were a rigid crane. The second step is to balance the moving part of the crane, ie the telescoping arm.

During the process the Dynamic Counter Weight System must be in it's middle position (50%) and NOT active.

To balance the crane correctly the FULL camera package and remote head must be loaded onto the front of the crane and if anything is changed on the camera package or remote head the crane must be rebalanced from the beginning.

B4.2.5.1 The Static Balancing

The objective of this initial balancing is to balance the mass of the front and the back parts of the crane.

Make sure that the crane has no Counter Weights on all three weight holders and that it is securely fastened to the base via the ratchet straps.

We start by putting the Sliding Weight and the Moving Weight Carriage in the central pivoting point of the Crane Arm. The Sliding Weight is moved by hand and the Weight Carriage is moved by powering up the crane.

To do the next step the crane must be switched off. Once all the movable weights are centred one of the ratchet straps can be loosened, but not taken off. Now weights are added to the Front and or Back Counter Weight Holders until the perfect balance of masses is achieved. When the nearly perfect balance has been reached take off both of the ratchet straps as they will slightly influence the weight. Now the final balancing can be done.

B4.2.5.2 The Dynamic Balancing

To do the Dynamic Balancing Counter Weights are added to both sides of the Weight Carriage until the maximum arm length is reached.

Once the Static Balancing has been achieved the ratchet straps are taken off and the crane arm can be extended. When the crane becomes front heavy, stop, and add weight until the correct balance is achieved.

This process is repeated until the Crane Arm is at the maximum length and is balanced through out it's entire length.

At the end when the maximum length has been reached the smaller sized weights are used to reach the correct balance.

Once the correct balance has been achieved the Sliding Weight can be used for fine balancing at different Crane Arm angles.

To reach 100% perfect balance automatically throughout the full movement of the arm the Dynamic Counter Weight System can be used. This lets us move the position of the weights on the carriage.

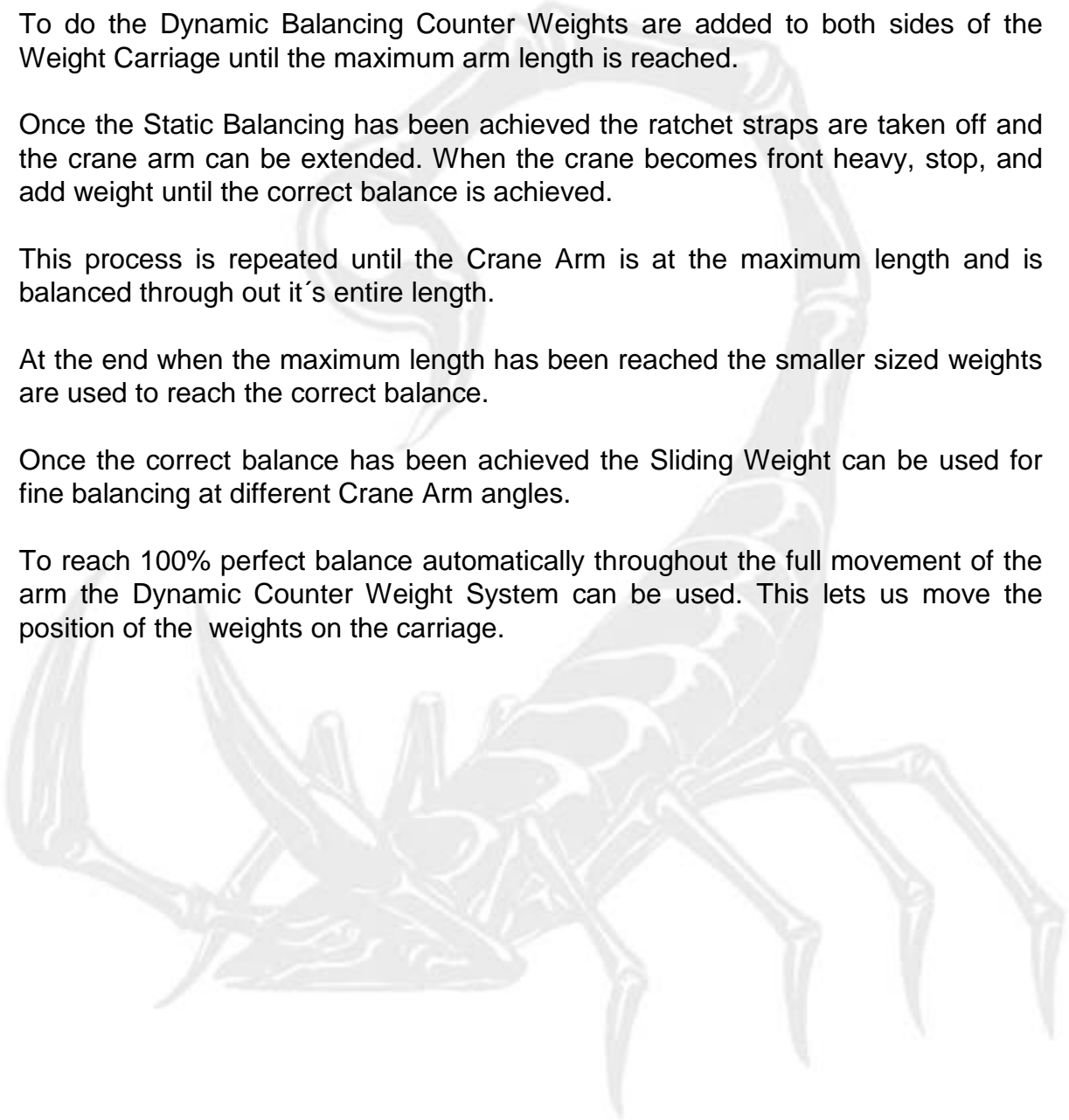

B5-. The Electronic Control Box

The SCORPIO 23' is controlled by an Electronic Control Box. The Electronic Control Box controls and drives the crane's motor which in turn moves the telescopic crane arm. It also controls other special features which puts the SCORPIO 23' apart from the other telescopic cranes. It serves as the Central Control Unit for the Leveling Head and the Dynamic Counter Weight System. It reads all the encoder information from all the cranes axes so that it can, later, be used by external systems.

The Electronic Control Box has a screen which is the "interface" between the user and the SCORPIO 23'.

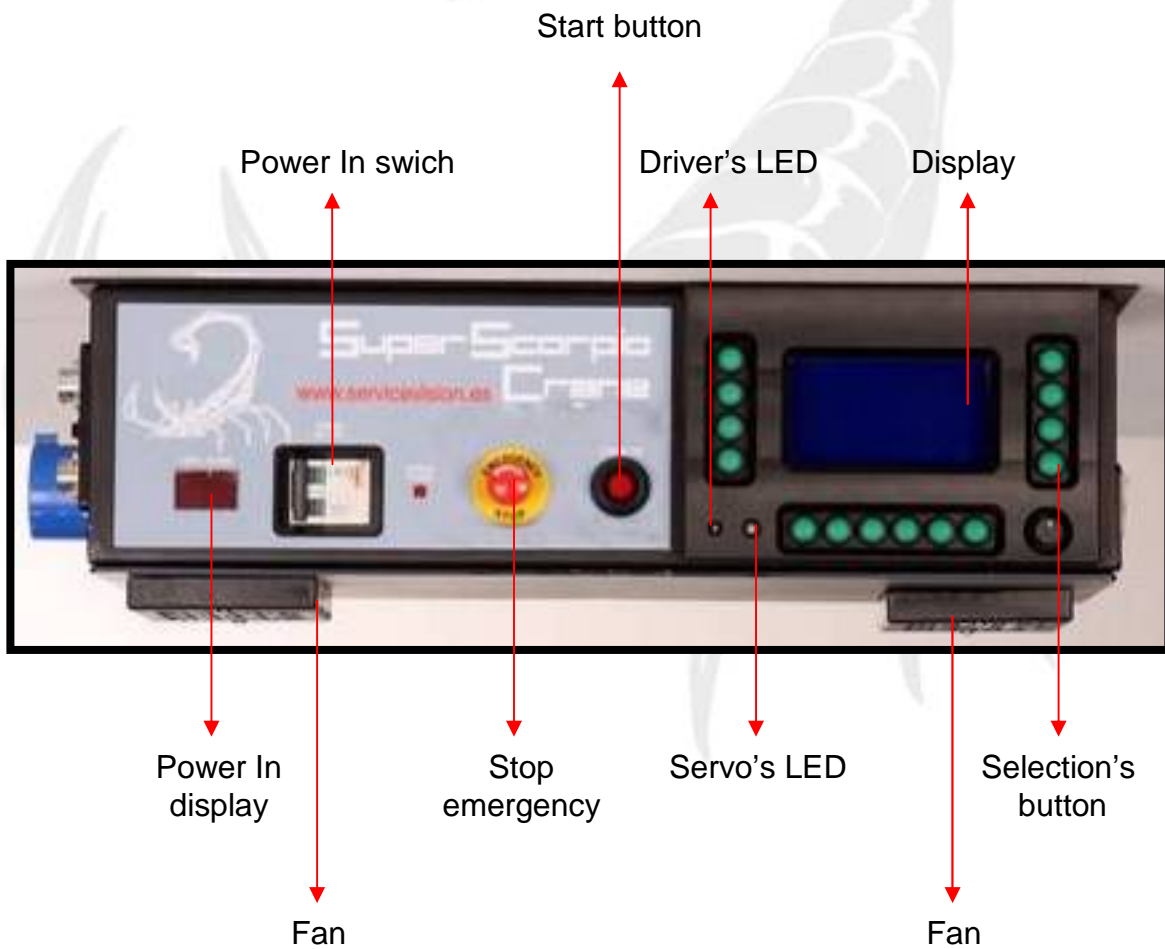

Motor's connector



Encoder output's connector
- D connector 25 female DB-25S-A191-A1977



Hand command's connector
- NEUTRIK 7pins panel female NC7FP1

Encoder output's connector
-D connector 25 female DB-25S-A191-A1977

13 B- ARM Brown
25 B- TRACK CRANE Brown
12 B+ ARM White
24 B+ TRACK CRANE White
11 A- ARM Blue
23 A- TRACK CRANE Blue
10 A+ ARM Green
22 A+ TRACK CRANE Green
9 –
21 B- TILT CRANE Brown
8 –
20 B+ TILT CRANE White
7 GND Green
19 A- TILT CRANE Blue
6 –
18 A+ TILT CRANE Green
5 –
17 B- PAN CRANE Orange
4 –
16 B+ PAN CRANE Yellow
3 RX Brown
15 A- PAN CRANE Black
2 TX Red
14 A+ PAN CRANE Red
1 –
26 –
27–

- Hand command's connector
- NEUTRIK 7pins panel female NC7FP1

1 Red (VCC +5)
2 Black (GND)
3 Blue (COMMAND)
4 Yellow (SPEED)
5 Orange (GREEN SWITCH - GND)
6 Grey (GND)
7 Purple (RELAY RED SWITCH)

AC Output Scoprio Head for power supply
 - BURNDY 4 pins female panel UT100-104ST

12V Output for monitor
 -NEUTRIK 4 pins female panel NC4 FP1

Dynamic Counterweight System Cable
 -BRUNDY 8 pins female panel UTGO 128S EB -001-2

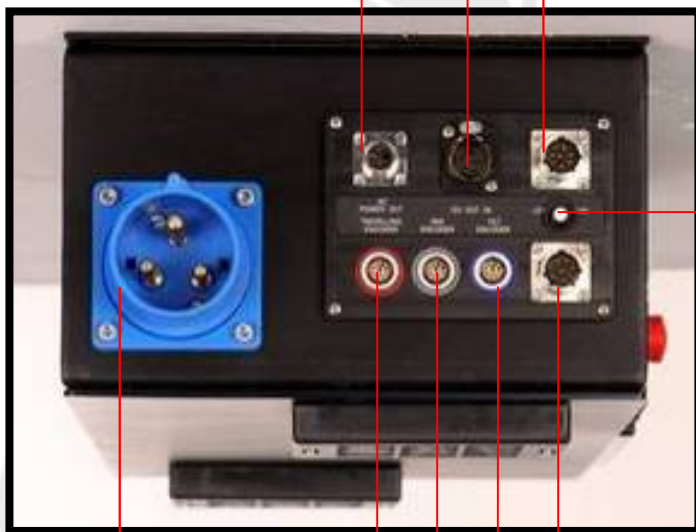

15A

Connector AC
 (110V a 240V 16A)

Leveling Head Cable
 -BRUNDY 8 pins female panel UTGO 128S

Input Tilt encoder
 - LEMO 10 pin female panel EGG -2B.310.CYM

Input Pan encoder
 - LEMO 10 pin female panel EGG -2B.310.CYM

Input wheel track encoder
 - LEMO 10 pin female panel EGG -2B.310.CYM

- AC Output Scoprío Head for power supply
-BURNDY 4 pins female panel UT100-104ST

1 Blue (VCC 220V)
2 -
3 Yellow (GND 220V)
4 Yellow – Green (GROUND)

- 12V Output for monitor
-NEUTRIK 4 pins female panel NC4 FP1

1 Black (GND)
2 -
3 -
4 Red (VCC +12V)

- Dynamic Counterweight System Cable
-BRUNDY 8 pins female panel UTGO 128S EB –001-2

1 Red (CVV +28V)
2 Black (GND)
3 Green (LEVEL A1+ OUT)
4 Blue (LEVEL A1 - OUT)
5 Grey (485 -)
6 Blue (485 +)
7 White (LEVEL B1 + OUT)
8 Brown (LEVEL B1 - OUT)

- Leveling Head Cable
-BRUNDY 8 pins female panel UTGO 128S

1 Red (CVV +28V)
2 Black (GND)
3 Green (LEVEL A1+ OUT)
4 Blue (LEVEL A1 - OUT)
5 Grey (485 -)
6 Blue (485 +)
7 White (LEVEL B1 + OUT)
8 Brown (LEVEL B1 - OUT)

- Input Tilt encoder
-LEMO 10 pin female panel EGG -2B.310.CYM

1 Red (VCC)
2 Black (GND)
3 Green (ENC A+)
4 Blue (ENC A-)
5 White (ENC B+)
6 Brown (ENC B-)
7 -
8 -
9 -
10 -

- Input Pan encoder
-LEMO 10 pin Female panel EGG -2B.310.CYM

1 Red (VCC)
2 Black (GND)
3 Green (ENC A+)
4 Blue (ENC A-)
5 White (ENC B+)
6 Brown (ENC B-)
7 -
8 -
9 -
10 -

- Input wheel track encoder
-LEMO 10 pin Female panel EGG -2B.310.CYM

1 Red (VCC)
2 Black (GND)
3 Green (ENC A+)
4 Blue (ENC A-)
5 White (ENC B+)
6 Brown (ENC B-)
7 -
8 -
9 -
10 -

B5.1 Functions

B5.1.1 Start up Procedure

Before the crane can be switched on the correct voltage, depending on the setting of the Voltage Selector Switch 110/220V, must appear on the volt meter “POWER IN”. Once the voltage has reached it’s peak the “START” button can be pressed.

After pressing the START button screen “1” will appear. It shows us that the system is trying to connect with the Motor and the Leveling Head axes.



Screen 1

If the Central Control Unit does not find one or both of these axes screen “2” will automatically appear and show us that there is a communication problem.



Screen 2

If the Central Control Unit finds all axes screen “3” will automatically appear and show us that the Leveling Head is searching the “0” or real horizon automatically.



Screen 3

Once the horizon has been reached screen “4” will automatically appear. While the crane is switched on the Leveling Head will maintain this level.

If we have not selected [Search Level] YES the system will pass straight on to screen “4”. The level at which the Leveling Head is will be memorized and will be kept while the crane is switched on.

In the case where the Leveling Head is not connected or there is a problem in the system, the screen will stay in screen “3” until the ESC button is pressed.

In this case the Leveling Head will not work.



Screen 4

Screen “4” only appears for a couple of seconds. It shows us which axes are connected. Axis 1 is the Arm Motor, axis 2 is the Leveling Head and axis three is Dynamic Counter Weight System.

After a few seconds screen “5” will appear. This screen tells us that the crane is moving with limited speed and that we must make one of the electronic limits. The crane has a Front Limit and a Back Limit. It does not matter which one we make. The crane needs to make a limit to be able to calculate where the Crane Arm is. The crane must be moved with the Hand Unit until it makes one of the limits.



Screen 5

Once the limit has been made screen “6” will appear.



Screen 6

This is the Principal Menu. The different features buttons and system information appear in this screen. The following system information appears:

- The type on crane being used, SCORPIO 23´
- The length of the crane arm in meters or feet (from the center of rotation).
- The position of the Dynamic Counter Weight System “CWE” in percentage.
- The PAN axis angle with respect to where the Crane Arm was when the system was switched on or from where the Crane Arm was when the “Pan Rest” from the “Settings” menu was pressed.
- The TILT axis angle with respect to the horizon.
- The height of the camera fixation plate with respect to the central rotation of the Tilt.
- The Arm Movement Speed from 0 –100. If the Speed setting is below 5, “Very Slow” [SCREEN 7], appears where the numbers normally are so that it is not thought that the crane is not working.
- The Damping level from 0, very hard – 40, very soft. This is how soft or hard the Crane Arm slows down. This setting does not effect the Programmable Limits or Final Arm Limit ramps.



Screen 7

From screen “6” the rest of the special functions menus and settings can be accessed.

B5.1.2 Settings “Settings”

From this menu all the system configuration tools can be accessed. By pressing the [Settings] button in the principle menu the Settings Menu is accessed. Once pressed screen “8” will appear.



Screen 8

By pressing the [Units] button the unit for measurement is changed. If “Meters” appears next to [Units] the measurements will be in meters. If “Feet” appears next to [Units] the measurements will be in feet.



Screen 9

By pressing the [Head Position] button the position of the remote head with respect to the Crane Arm is selected. If “Under Slung” appears next to [Head Position] it means that the remote head must be mounted below the Camera Fixation Plate. If “Over Slung” appears next to [Head Position] it means that the remote head must be mounted above the Camera Fixation Plate. This setting effects the way in which the Leveling Plate of the Leveling Head maintains the horizon. To change this setting the crane must be switched off/on for it to register the change.



Screen 9B

By pressing the [CWE Adj] button the Dynamic Counter Weight Adjustment Menu is accessed. Once pressed screen “10” will appear. In this menu different Counter Weight Carriage positions, in relation to the Crane Arm length, can be programmed. This is used to generate a movement of the Counter Weight Carriage in order to balance the Crane Arm.

In this menu the CWE is activated or deactivated. The points that we have programmed with the “Add Point” button, the Crane Arm length and the position of the CWE expressed in percentage can be seen.



Screen 10

By pressing the [Enable] button the CWE is activated or deactivated. If “YES” appears next to [Enable] the Electronic Control Box will let the CWE be controlled by the Program that the operator programs.

If “NO” appears next to [Enable] the system will not let the CWE be controlled by the program and no automatic motion will be generated. However, the Dynamic Counter Weight Carriage can still be moved by pressing the Green button and the Tight/Wide potentiometer at the same time. In this case screen “11” will appear.



Screen 11

When ever a new CWE motion is programmed the previous program must be erased. To erase the previous program the “Reset Point” button is pressed.

To program the CWE the arm must start from it’s shortest length. By pressing the Green Button on the Hand Unit and the Tight/Wide Potentiometer at the same time the CWE is moved. The CWE is moved until the perfect balance is found and then the “Point” is programmed”. To Program the “Point” the “Add Point “ button is pressed (Screen 11B). This process is repeated throughout the whole range of the Crane Arm.



Screen 11B



Screen 11C

This program is activated from the Principle Menu.

By pressing the [Back] button the system returns to the “Settings” menu.

By pressing the [Search Level] button the horizon is set manually “No” or automatically “Yes”. If “Yes” appears next to [Search Level] the Leveling Head will automatically search the real horizon. If “No” appears, the horizon can be manually set by the operator. This case is used for if a “off set” on the horizon is wanted and as a back up for if something goes wrong with the automatic leveling.



Screen 12

By pressing the [Pan Rest] button the Pan degree counter in the Principal Menu (Screen 6) will be reset and will start from zero. This function is used to reset the “0 degrees” of the Crane Arm pan axis.

By pressing the [Aux] button twice the Aux menu is accessed. This menu is used to verify and adjust the electronic system. Once pressed screen “12” will appear.

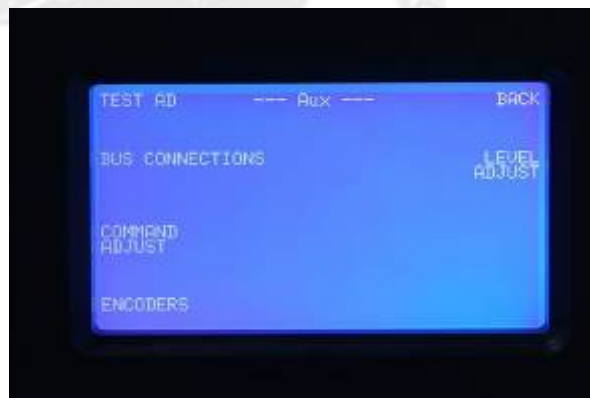

Screen 13

By pressing the [Test AD] button the Analog to Digital Converter menu is accessed. Once pressed screen “14” will appear. In this menu the Analog to Digital Converters of the Central Control Unit can be checked. With this information the functionality of each potentiometer within the system can be checked and a problem can be distinguished to be a potentiometer or another part of the system.



Screen 14

By pressing the [Bus Connections] button the Bus Connections menu is accessed. Once pressed screen “15” will appear. In this screen the connected circuit boards and the software versions and their release dates can be seen.

In this display we can detect what axis are connected and we can verify the version of the software they have. The most important one is the axis CONTROL who determinate the version of the software of the crane. This is the number that changes when we upgrade the software of the crane.



Screen 15

By pressing the [Command Adjust] button the Command Adjust menu is accessed. Once pressed screen “16” will appear. In this screen adjustments can be made to the Tight/Wide potentiometer, “zero window”, on the Hand Unit. An automatic zero can also be recalibrated on the Tight/Wide potentiometer for if there were any interference effecting it.



Screen 16

By pressing the [Zero Drift] button the system sets an automatic zero on the Tight/Wide potentiometer. The system does an automatic re-zero on the Tight/Wide Potentiometer, by it's self, for if there were any interference effecting it but it can also be done manually from this menu by pressing [Zero Drift].

By pressing the [Window Adjust] button the Window Adjust menu is accessed. Once pressed screen “17” will appear. If the response of the Tight/Wide potentiometer seems to fast or to slow it can be adjusted by entering into this menu. By pressing “+” button the zero window will be maximized and by pressing the “-” button the window will be minimized.

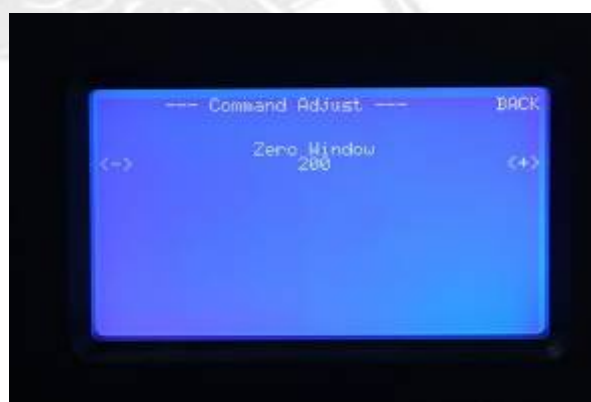

Screen 17

By pressing the [Encoders] button the Encodes menu is accessed. Once pressed screen “18” will appear. In this menu the encoders that read the Pan, Tilt and Travelling are verified. If the numbers do not change from zero it means that the system is not receiving a signal from the respective encoder.

With this information a problem can be distinguished to be an encoder or another part of the system thus helping the technician trouble shoot.



Screen 18

By pressing the [Level Adjust] button the Level Adjust menu is accessed. Once pressed screen “19B” will appear. This menu is the most delicate and thus the button must be pressed three times to gain access. In this menu the Leveling Head adjustments are made.



Screen 19

If the Leveling Head is not connected or there is a problem with the communication or cables, screen “19C” will appear. This screen tells us that there is a communication problem.

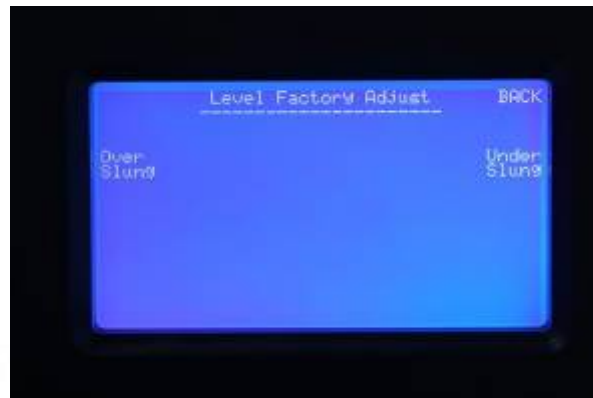

Screen 19B



Screen 19C



Screen 19D

B5.1.3 Limits “Limits”

By pressing the [Limits] button the Limits menu is accessed. Once pressed screen “20” will appear. In this menu two electronic arm length limits can be set.



Screen 20

Before setting the limits “Clear All” must be pressed to clear all previous limits. Now, the crane arm is moved to the first position where the first limit is wanted and “Set” is pressed. A first open bracket will appear in the menu. Then the arm is moved to the second position where the second limit is wanted and “Set” is pressed again. A second closed bracket and the option to clear just one of the limits will appear in the menu (SCREEN “22”).



Screen 21



Screen 22

If the limit closest to the remote head is wanted to be erased the “Clear[” button is pressed and if the limit closest to the crane is wanted to be erased press the “Clear]” button. If both of the limits are not set the system will not detect any limit and the arm will be able to move throughout the whole normal range.

When the systems is switched off the limits are lost.

B5.1.4 The Arc Compensator “Arc Comp”

If the [Arc Comp] button is pressed “Yes” will appear next to [Arc Comp] and the Arc Compensator will be activated. This feature compensates for the arc generated when both the Pan and/or Tilt are moved. The compensation is automatic, works in any arm position and does not effect the normal operation of the arm. Once the Arc Compensator has been activated “Yes” will appear next to [Arc Comp] (Screen 23). The arm will telescope by it’s self correcting the arc generated by the Pan and/or Tilt movement. The Tilt compensation limit depends on the arm length and the Pan can correct until +50° and -50° from it’s “ 0° ”. The crane makes it’s own “ 0° ” on both the Pan and Tilt when you switch on the crane.

When the Arc Compensator is activated the Motion Generator and Limits disappear.



Screen 23

B5.1.5 Dynamic Counter Weight System Generator “CWE Gen”

If the [CWE Gen] button is pressed “Yes” (Screen 24) will appear next to [CWE Gen] and the CWE Generator will be activated. The CWE Generator will move the Dynamic Counter Weights in accordance with the preprogrammed points at the preprogrammed arm lengths in the display [CWE Adj] from Settings. If the CWE Generator is not activated (Enable: [No] in the CWE Adj screen) this button will not appear (screen 25).



Screen 24



Screen 25

B5.1.6 Motion Generator “MOTION GENERATOR”

This feature lets us do an arm motion generation depending on the position of the Pan or Tilt encoder.

If the [Mo Gen] button is pressed screen “26” will appear. In this menu the points can be programmed and the program can be activated.



Screen 26

To start off, using the [Pan/Tilt] button, the Pan or Tilt encoder is selected as the one who will generate the arm movement. The one that is seen on the screen [Pan/Tilt] is the one that will be used as the reference (Screen 26/27).



Screen 26



Screen 27

Next the [Reset] button is pressed to reset all previously programmed points. The “0” next to the word “Points” must be checked to make sure that the points memory has been erased (Screen 26).

Starting from the first position and having in mind that the movement must only be in one direction the first point is programmed. To program points the [Insert] button is pressed. It is know that the point has been programmed by the “1” that will appear next to the word “Points” (Screen 28).

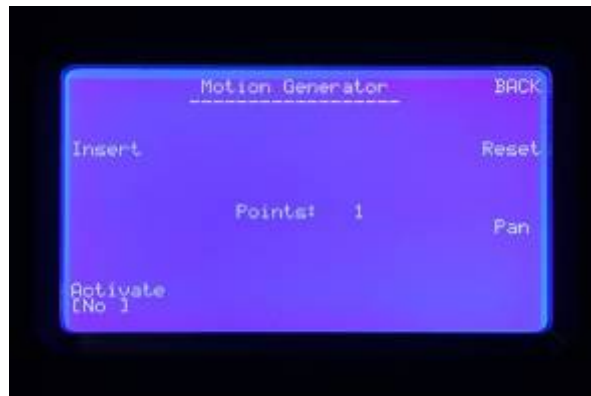

Screen 28

The Crane Arm is panned or tilted and the telescopic arm moved again until the second position. [Insert] is pressed again to program the point and a “2” will appear. This process is carried out until we reach the end position of the move. The more points that are programmed the better the crane arm movement will be. Not like the angular movement of the arm the telescopic does not have to be in the same direction.

Once the movement has been programmed the [Activate] button is pressed and the system will follow the program. Next to [Activate], “Yes” will appear meaning that the crane is being moved by the program (Screen 29).



Screen 29

If the program is activated at a point where the arm position does not co-inside with a preprogrammed encoder angle “30” will appear on the screen. This means that the arm is moving, slowly, to the position that co-insides with the preprogrammed encoder angle.



Screen 30

Once the Motion Generator has been activated the telescopic arm will respond automatically to the angular movement of the Pan/Tilt.

To deactivate the program the [Activate] button is pressed and “No” will appear next to [Activate]. If the Motion Generation screen is exited the program is automatically deactivated for security reasons.

B5.1.7 Sequential Limits “STOP SEQUENCE”

This feature allows for the programming of sequential crane arm limits. By pressing the [Stop Seq] button screen “31” is accessed.



Screen 31

Before starting the program the [Reset] button must be pressed and it must be checked that there is a “0” next to the word “Points”. Starting from the Crane Arm’s shortest length the arm is moved to the first “Stop” and the “Insert” button is pressed. A “1” will appear on the screen where the “0” was (Screen 32). This process is repeated until all the “Stops” have been inserted.

The Stops must be programmed in one direction only. It is not possible to change direction while programming stops.



Screen 32

Once all the stops have been programmed the Crane Arm is brought back to it’s closed position and the [Activate] button is pressed. Next to [Activate] “Yes” must appear, indicating that the program is active. Once the program has been activated the [Insert] button will disappear and the word “Point” with a “1” next to it will appear. Even if more than one Stops has been programmed the “1” shows that the Stop Sequence is working between the normal closed position and the first programmed Stop (Screen 33).

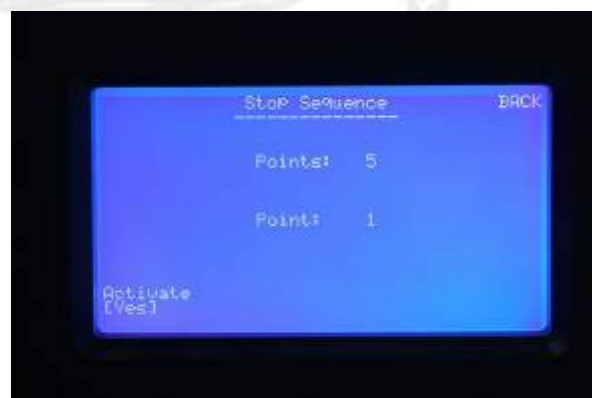

Screen 33

The arm can now be telescoped between these two points. When the second stop is wanted to be reached the Green button on the Hand Unit is pressed and a “2” will appear next to the word “Point”. Now the arm can be telescoped between the closed position and the second programmed Stop (Screen 34).



Screen 34

This process is repeated to change from Stop to Stop until the last programmed Stop.

When the first Stop is wanted as the limit the [Initial Stop] button is pressed and the program goes back to the first programmed Stop “1” (Screen 33).

To deactivate the program the [Activate] button is pressed and a “No” must appear next to [Activate]. If this menu is exited the program will be deactivated automatically for security reasons.

B5.2 Hand command





Hand command's connector
-NEUTRIK 7 pins male panel NC7 MD LX

Speed control

- 1 Red
- 2 Black
- 3 Blue
- 4 Yellow
- 5 Brown
- 6 Green
- 7 Orange

B6-. Leveling Head

The SCORPIO 23´ has a Leveling Head that will maintain the Real Horizon or a set horizon depending on the setting in the Settings menu.

This leveling head can work in two positions, Over Slung and Under Slung. For these functions to work correctly they must be set in the Settings menu.

The Leveling Head is fastened to the Crane Arm with six bolts which must all be present at all times. Three go on one side and the other three on the other.

The Leveling Head Fastening Plate is bolted with four bolts to the last of the telescopic tubes. This fastening plate has four holes with slight play to allow for adjustment of the Leveling Head horizon.

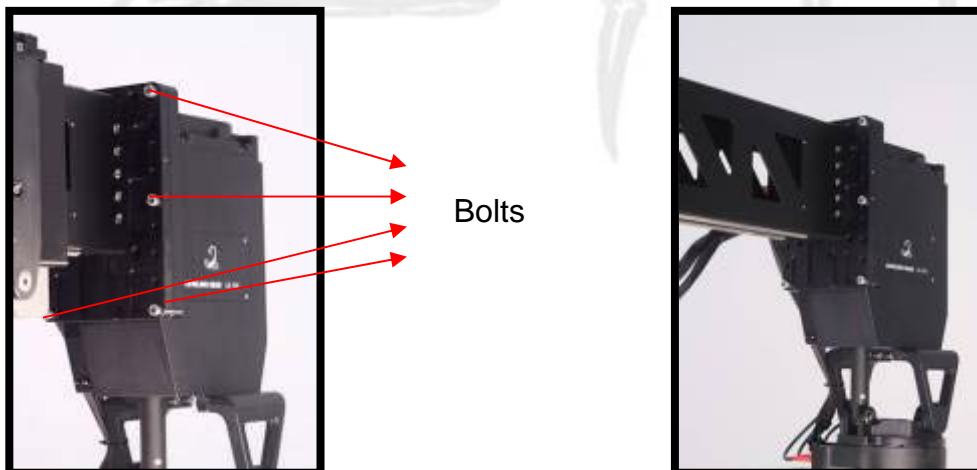
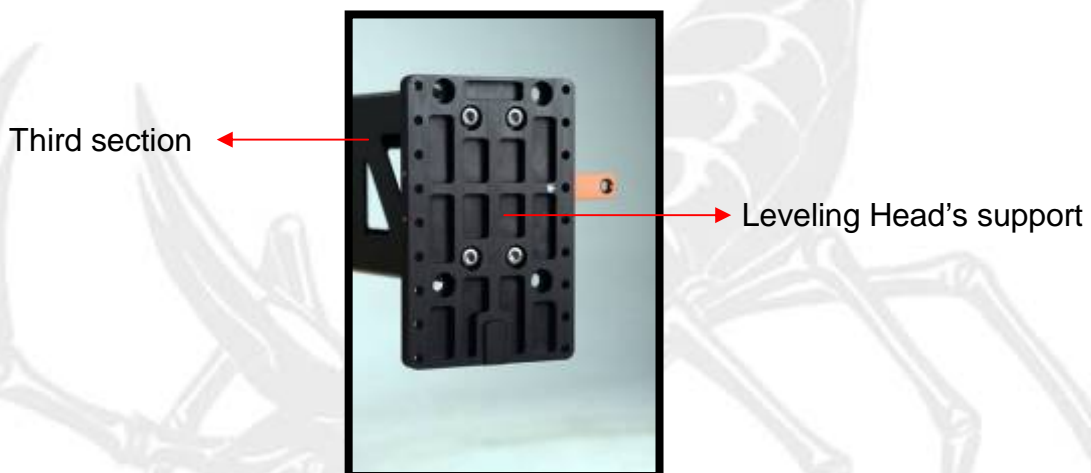

To invert the Leveling Head the six bolts are removed and the Leveling Head inverted.

The Leveling Head cable must be connected and the LEDs must turn green.

The maximum weight that can be mounted on the Leveling Head is 70 kilograms in the Under Slung position and 30 in the Over Slung position. This includes the remote head and the camera package.

