

DVD-ME1

DVD+CD+MP3 Player

Owner's Manual



DVD
VIDEO

● BLAUPUNKT®

TABLE OF CONTENTS

Safety Precautions	2	Play Discs in Various Ways	
Safety Concerns	3	Mute	13
Key Features	4	Fast Play	13
Playable Discs	4	Slow Play	13
What is MP3?	4	Repeat Play	14
Installation Warnings	5	Select Subtitles	14
Installation Tools	5	Select Angles	14
Terms for Discs	5	Zoom Play	14
Technical Specifications	6	Function Setting	
Troubleshooting	6	Menu Setting	15
Note on Copyright	6	TV Display	16
Preparation Before Operation		TV Type	16
Remote Control	7	Angle Mark	16
Front Panel	7	Captions	16
Display	8	Screen Saver	16
Rear Panel	8	Compression	16
Names and Layout of Remote Controls	8	Dual Mono	16
Connect to a Mobile Amplifier	9	Dynamic Ring	16
Connect to a TravelPilot DX-N	9	Front Speaker	16
Connect to a TV/Monitor	10	Password Set Up	17
Connect to Home Amplifier	10	Preferences	17
Basic Operations		MP3 Operations	
TV/Video Selection	11	Play Discs	18
Play Discs	11	Repeat Play	18
System Settings	11	Other Functions	18
Pause	11	Others	
OSD (On-Screen-Display)	12	Using Headphone	19
Volume Control	12	Installation Guide	19
DVD Menu Play	12	Limited Warranty Information	20
Audio Mode	12		

SAFETY PRECAUTIONS

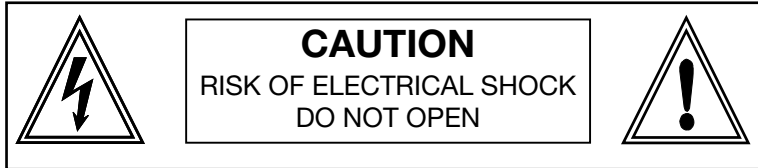

WARNING! To reduce the risk of fire or electric shock, do not expose this appliance to rain or moisture. Dangerous high voltages are present inside the enclosure. To prevent electrical shock, do not open the cabinet.



The lightning flash with arrowhead symbol within and equilateral triangle is intended to alert the user to the presence of uninsulated "dangerous voltage" within the product's enclosure that may be of sufficient magnitude to constitute a risk of electric shock to persons.



The exclamation point within and equilateral triangle is intended to alert the user to the presence of important operating and maintenance (servicing) instructions in the literature accompanying the product.

CAUTION TO PREVENT ELECTRIC SHOCK MATCH WIDE BLADE OF PLUG TO WIDE SLOT, FULLY INSERT.

CAUTION This unit employs a laser system. To ensure the proper use of the unit, read this manual carefully and keep it for future reference. If the unit requires servicing, contact the retailer and or Blaupunkt service center - see "Limited Warranty Information". To prevent direct exposure to the laser radiation, do not open the cabinet or back of the unit.

NOTE: This equipment has been tested and found to comply with the limits for a Class B digital device, pursuant to part 15 of the FCC Rule. These limits are designed to provide reasonable protection against harmful interference in a residential installation. This equipment generates, uses, and can radiate radio frequency energy and if not installed and used in accordance with the instructions, may cause harmful interference to radio communications. However, there is no guarantee that interference will not occur in a particular installation. If this equipment does cause harmful interference to radio or television reception, which can be determined by turning the equipment off and on, the user is encouraged to try to correct the interference by one or more of the following measure:

- * Reorient or relocate the receiving antenna
- * Increase the separation between the equipment and receiver.
- * Connect the equipment to an outlet on a circuit different from that to which the receiver is connected.
- * Consult the dealer or an experienced radio/TV technician for help.

SAFETY CONCERNS

We always recommend you have your Blaupunkt DVD/MP3 player professionally installed but the installation process is often so easy that the average consumer can achieve success with little trouble. All operating instructions should be followed. Regardless of person installing, you should be sure to review the following points before proceeding with the installation:

- **READ THE MANUAL!** Understanding the product and installation limitation before lifting a screwdriver. Follow Instructions -
- **POWER SOURCES** - Make sure to use operate only from the type of power source indicated on the rear panel. For products intended to operate from battery power, or other sources, refer to the operating instructions. Do not overload the power source to prevent a risk of fire or electric shock.
- **POWER LINES** - An outside antenna system should not be located in the vicinity of overhead power lines or other electric light or power circuits, or where it can fall into such power lines or circuits. When installing an outside antenna system, extreme care should be taken to keep from touching such power lines or circuits as contact with them might be fatal.
- **POWER CABLE** - Make sure to route power cables appropriately so that they are not likely to be walked on or pinched by items placed upon or against them, paying special attention to cords at plugs, convenience receptacles, and the point where they exit from the product.
- **CLEANING** - Disconnect this product from the power source before cleaning. Do not use liquid cleaners or aerosol cleaners. Use a damp cloth.
- **WATER & MOISTURE** - Do not use this product near water.
- **ACCESSORIES** - Do not place this product on an unstable object. Any mounting of the product should follow the manufacturer's instructions, and should use a mounting accessory recommended by the manufacturer.
- **LIGHTNING** - During a lightning storm, or when it is left unattended and unused for long periods of time, unplug it from the power source prevent damage to the product due to lightning and power-line surges.
- **OBJECT & LIQUID ENTRY** - Never push objects of any kind into this product and/or liquid entry to product could result in a fire or electric shock.
- **SERVICING** - Any attempt to service this product yourself as opening or removing covers may expose you to dangerous voltage or other hazards.
- **DAMAGES REQUIRING SERVICE** - Disconnect this product from the power source and refer servicing to qualified service personnel under the following conditions;
 - a) Damage to the power cord or plug
 - b) Water damage
 - c) Product malfunction or change in performance
 - d) If the product has been dropped
- **PART REPLACEMENT** - Make sure to use the replacement parts specified and/or approved by the manufacturer to prevent potential fire, electric shock or other hazards. Upon completion of any service or repair, be sure to perform safety checks by qualified service personnel.
- **WEAR SAFETY GLASSES AT ALL TIMES** - Flying debris are always dangerous.
- **PROTECT THE VEHICLE** - Always disconnect the negative battery cable before starting any kind of installation work. This prevents a possible high current electrical short (potential fires).
- **HEAT** - Keep all products away from nearby hot components such as amplifiers, radiators, heat registers, stoves or vehicle components that heat up over time such as hoses, high current wires, and braking systems components. Make sure to leave enough room for ventilation on openings and slots to protect if from over-heating.
- **GIVE YOURSELF LOTS OF TIME** - Rushing to complete an installation nearly always ends up with problems.
- **WHILE DRIVING, KEEP EYES ON THE ROAD AND NOT ON THE MONITOR. KEEP THE VOLUME LOW.**

Please record the model and serial number located at rear panel.



Model No. _____

Serial No. _____





THANK YOU FOR CHOOSING BLAUPUNKT!

Congratulations! You are now the owner of an exceptional in-car (12VDC) & home (110VAC) DVD/MP3 player from the audio and video enthusiasts at Blaupunkt. Not only do we offer you a great product but also a supportive owner's manual. Although technically informative, we are also very concerned about the end consumer using proper installation techniques for the highest performance possible from their new in-car & home DVD/MP3 player. Most important to us are concerns with safety and the installation process. Since our Blaupunkt retail dealers have the tools and experience for an optimized and safe installation, we always recommend they do the final vehicle integration. But, should you choose to install these products yourself, please take the time to read this manual completely and abide by all precautions.

KEY FEATURES

- 1. SUPERB SOUND QUALITY:** Dolby Digital  system developed by Dolby laboratories and DTS  developed by DTS Inc., features in DVD and audio CD. *Some DVD/MP3 player might not ready for DTS features.
- 2. HIGH DEFINITION:** The unit adopts MPEG2 coding format and brings the horizontal resolution over 500 lines.
- 3. UNIQUE FUNCTIONS:** Multi-angle and multi-language bring unique functions if your DVD media has capability.
- 4. COMPATIBILITY:** Compatible with most DVD, SVCD (Super Video CD), VCD (Video CD), CD & MP3 formatted disc (see below).
- 5. ZOOM & ANGLE:** Enjoy up to 4 times larger pictures on your monitor.

PLAYABLE DISCS

TYPE	DISC LOGO	CONTENTS	DISC SIZE	PLAY TIME (approx.)
DVD Video*		Audio + Video (motion pictures)	12cm	2h (for single-sided DVD), 4h (for double-sided DVD)
			8cm	80min (for single-sided DVD), 160min (for double-sided DVD)
Super Video CD/ Video CD		Audio + Video (motion pictures)	12cm	SVCD (45 mins), VCD (74 mins)
			8cm	VCD (20 mins)
CD		Audio	12cm	74 mins
			8cm	20 mins
MP3**		Audio	12cm	10+ hours (128kbits per second or higher compression recommended)

* Region codes for DVD disc is printed on the rear panel, only the disc with same code can be played.

**This product reads MP3 formatted CD-Rs (CD-Recordable). CD-RW (CD-rewritable) media does not work in the player.

WHAT IS MP3?

It is the compression technology developed by MPEG (the Moving Picture Experts Group) in 1988. MPEG had developed a compression system for digital television video data and their accompanying soundtracks. The part of the MPEG format is MPEG audio Layer-3, abbreviated as MP3. It is a special compression technology to fit in smaller spaces for example, DVD movies, HDTV broadcasts and DSS satellite systems.

A typical MP3 files is about 1/11 the size of an equivalent CD-audio file. Therefore, about 13 hours of CD-quality songs can be stored in MP3 format. A CD stores songs as digital information. The data on a CD uses a high-resolution, uncompressed format. Music's analog waveform on digital media (CDs and CD-Rs) is sampled 44,100 times per second (44.1KHz). The samples are 2 bytes (16 bits) long, and there are 2 separate channels for left and right speakers for stereo sound. Thus, CD stores 1,411,200 bits per second. (44,100 samples/second x 16 bits/sample x 2 channels) 1.4 million bit per second is 176,400 bytes per second. If an average music is 3 minutes long, music consumes about 32Mbytes of space on CD. An audio CD has a capacity of 654.7 MB, and can store up to 74 minutes of music. The most common bit rate for MP3 is 128,000 bits per second (128K), which produces very close to CD-quality sound, 1,411,200 bits per second. Now, you see a tremendous space reduction to 9 percent. The more bit rate is the better sound quality, but more space to store.

NOTE on MP3: For high quality sound, we recommend converting MP3 files with sampling frequency of 44.1KHz and a fixed bit rate of 128kpbs. Note that the unit may not play tracks in the order that you record them to the disc.

INSTALLATION WARNINGS!

Before disassembling your beautiful new car you need some basic installation knowledge and skill with common hand and power tools. Following such basic installation tips and warnings will prevent possible damage to the vehicle and also prevent possible fires.

- AGAIN...READ THE MANUAL! There is a lot of helpful information in this manual that will save time and prevent problems later.
- COVER THE VEHICLE WORK AREAS - Use fender covers or blankets to protect the work areas from scratches or dings.
- DISCONNECT THE (-) LEAD ON THE BATTERY - No sparks or fires please!
- "REVIEW" THE INSTALLATION - Before using any tools or moving vehicle components, take five minutes to review the installation intentions.
- "REVIEW" THE VEHICLE - Before drilling any holes or cutting into any surfaces, make sure there are no fuel or hydraulic lines behind the surfaces. Also make sure there are no wires routed directly behind or near the desired mounting.
- ENSURE PROPER FIT - Before cutting or drilling, make sure the DVD/MP3 player will physically fit in its desired location. Check for clearance around rear deck torsion bars or other structural elements.
- EVERY CAR IS ASSEMBLED DIFFERENT - Every auto manufacturer uses different assembly techniques. Take care in removing/modifying all trim panels and mounting surfaces since they often use unique screws or snap fasteners that are difficult to replace if they are lost or broken.
- BE CAREFUL WITH CABLE ROUTING - When routing audio cables, make sure RCA and speaker wires are routed away from high current power lines for audio amplifiers and vehicle systems lines when possible. This will help prevent noises from creeping into the audio system, plus prevent potential damage to the vehicle wiring itself.
- BE CAREFUL WITH ALL CONNECTIONS - When making connections, make sure each connection is clean and properly secured. Observe all polarity markings carefully to ensure proper end performance.
- CAUTION - FUEL TANKS AND FUEL LINES ARE NOW LOCATED DIRECTLY BENEATH THE REAR DECK IN MANY CARS - CHECK FOR ADEQUATE CLEARANCE BEFORE EVEN CONSIDERING SUCH A MOUNTING LOCATION!

INSTALLATION TOOLS

For most installations, simple hand tools are adequate to install an aftermarket products. Depending upon the mounting locations used, you will need power tools for drilling and cutting plastics and metal. A good starting list is summarized below:

- Tape measure and ruler
- Marking pen and starting punch
- Phillips and flat blade screwdrivers (small and medium sizes)
- Nylon wire bundle ties
- Pliers: standard vice-grip and needle nose styles
- Light-duty trim pry-bar for removing door trim
- Cutting shears or nibbling tool for cutting thin and medium gauger metal
- Wire cutters, wire strippers, electrical tape, crimping pliers and appropriate crimp-on terminals
- Power drill with appropriate sized drill bits

TERMS FOR DISCS

- **TITLE:** The longest sections of a picture or music segment on a DVD. Each title has an indication number, which makes it easy to locate.
- **CHAPTER:** It is smaller than title. A title is composed by several chapters. Each chapter has an assigned number for search.
- **TRACK:** The image or music in a CD. Each track has a number for search.
- **SCENE:** The menu pictures, motion & motionless pictures for SVCD with PBC function can be divided into some parts, the parts are scenes.
- **PBC:** Playback operations on SVCD/VCDs. Some playback operations of VCDs may be embedded by software producers. This feature may not be available all VCDs. Please refer to the supplied manual in your VCDs.

CONDENSATION: Water will appear on the pick up lens with sudden temperature increase. Please do not use this unit in a humid place. In case of malfunctioning of the unit due to high condensation, unload the disc and leave the unit on for about an hour to evaporate condensation.

CLEANING: Use soft cloth with a little neutral detergent to wipe the cabinet, panel and controls. Never use any type of solvent, such as thinner or benzene.

HANDLING DISC: Do not touch the play side of the disc. Do not attach paper or tape on the disc. Keep the disc away from direct sunlight or heat source. Store the disc in a disc case after playback. Wipe the disc outwards from the center with clean clothe before playback

TECHNICAL SPECIFICATIONS

Power supply	DC12V, 1.5A
Power Consumption	≤ 20W
Operating Temp.	5°C to 35°C (41°F to 95°F)
Dimensions	170 x 73 x 215 mm (W/H/D)
Weight	1.4Kg
Signal system	NTSC (US)/PAL/AUTO
Laser	Wavelength 650nm
Audio Output (Analog)	Output level: 1.5 ± 0.25V Load impedance: 10KΩ
Video output	Output level: 1 ± 0.2V Load impedance: 75Ω
Headphone out	Jack type: Ø 3.5mm headphone jack
Frequency response	10Hz~20KHz ± 0.5dB
Signal/noise ratio	≥ 110dB ("A" weighted)
Audio distortion + noise	≤ -70dB (1KHz)
Channel separation	≥ 85dB (1KHz)
Dynamic range	≥ 90dB (1KHz)

Supplied Accessories

Audio cable (red and white, 18 ft.)	1 pair
Video cable (white, 18 ft.)	1
Remote control	1
AAA batteries	2
External remote sensor	1
Face bezel	1
DC 12V Power cord (mobile)	1
AC adapter Input: 100-240V~30W 50/60Hz Output: DC 12V 1.5A (home)	1
Mounting brackets (horizontal & trunk mount)	2
Mounting screws	8
Protecting pad	1
Noise filter for power source	1
Owner's manual	1

TROUBLESHOOTING

No power:	Check power connection to the unit +12 volt, ground, and remote lines. Use voltmeter to verify voltages are at terminals of the unit.
No picture:	Check video cable connection, color adjustment, and monitor operation.
No sound:	Check audio cables connection, amplifier or source connection to set receiving DVD signal output. Check audio mode setting.
Image distortion:	Check signal system (NTSC, PAL, AUTO). Eject the disc and clean it.
Remote control trouble:	Check batteries. Point the remote control at the remote control sensor of the unit.
No disc playback:	Make sure insert a playable disc (check the disc type, region code and color system). Place disc playback side down in the proper guide. Clean the disc. Cancel or change the parental lock function. (The factory pre-set is 99999.) Turn power switch or power connection on and off.

NOTE ON COPYRIGHT

- This product incorporates copyright protection technology that is protected by method claims of certain U.S. patents and other intellectual property rights owned by Macrovision Corporation and other rights owners. Use of this copyright protection technology must be authorized by Macrovision Corporation, and is intended for home and other limited viewing uses only unless otherwise authorized by Macrovision Corporation. Reverse engineering or disassembly is prohibited.
- Manufactured under license from Dolby Digital Laboratories. "Dolby" and the Double-D symbol are trademarks of Dolby Laboratories. Confidential unpublished works. (c) 1992-1997 Dolby Laboratories, Inc. All rights reserved.
- DTS and DTS Digital Out are trademarks of Digital Theater System, Inc.

PREPARATIONS BEFORE OPERATION

Remote Control

1. Open the battery cover

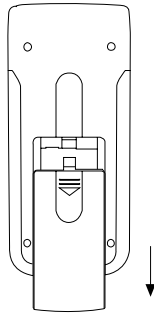

2. Insert two AAA batteries, make sure to match "+" and "-" on the batteries to marks inside the battery compartment,

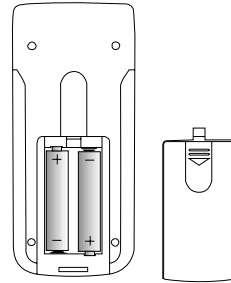

3. Close the battery cover.

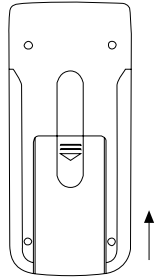

4. Point the remote control at the external remote sensor or point the remote control at the display window, operate in the range of 5 meters and 30° from the front of the remote sensor. Make sure there is no barrier between them.

Notes:

1. The batteries can last about 6 months generally. Change the batteries if the remote control does not work.
2. If the remote control is not used for a long time, remove the batteries to prevent battery leakage.

Front Panel



- | | |
|--------------------|---------------------|
| ① Power On/Standby | ⑥ Stop |
| ② Disc Tray | ⑦ Display |
| ③ Play | ⑧ Standby Indicator |
| ④ Open/Close | ⑨ Headphone Jack |
| ⑤ Pause | |

PREPARATIONS BEFORE OPERATION

Display

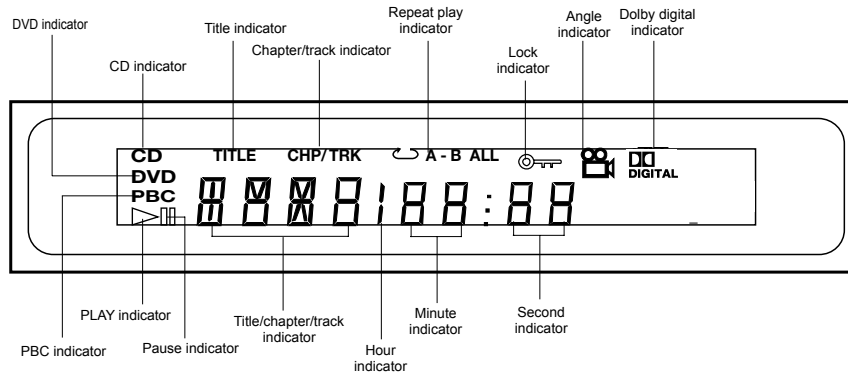

Rear Panel

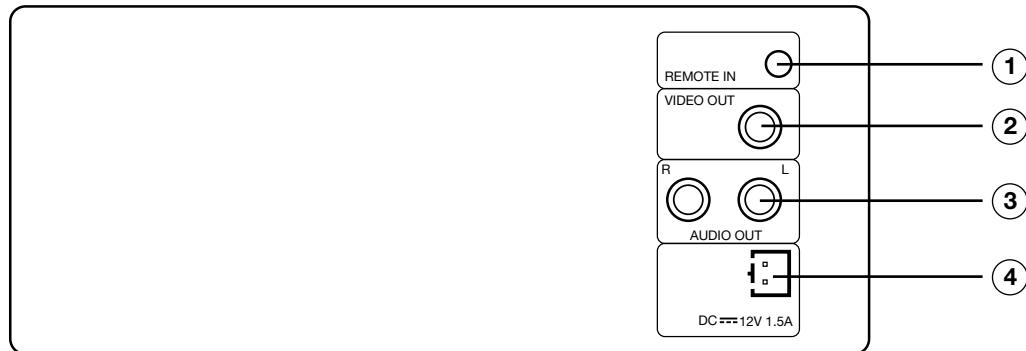

- ① Remote In ② Video Out ③ Audio Out ④ DC In

Names and Layout of Remote Controls

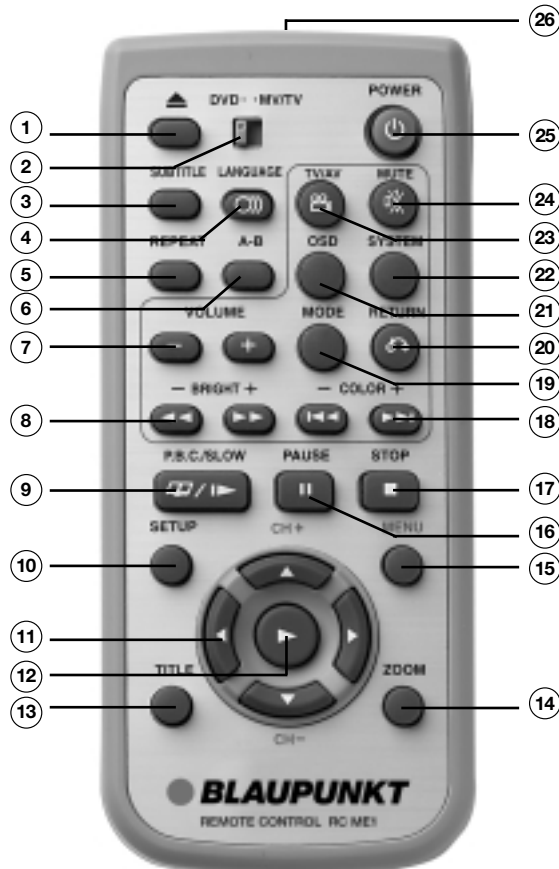

- ① Open/Close
- ② DVD & MV/TV Select
- ③ Subtitle
- ④ Language
- ⑤ Repeat
- ⑥ A-B repeat
- ⑦ Volume
- ⑧ FR/FF Search
- ⑨ P.B.C. (Left Side)
- ⑩ SetUp Menu
- ⑪ Direction Buttons
- ⑫ Play
- ⑬ Title
- ⑭ Zoom
- ⑮ Menu
- ⑯ Pause
- ⑰ Stop
- ⑱ Previous/next
- ⑲ Audio Mode
- ⑳ Return
- ㉑ OSD (On-Screen-Display)
- ㉒ System
- ㉓ Angle
- ㉔ TV/AV Select (For MV/TV)
- ㉕ Mute
- ㉖ Power
- ㉗ Remote Transmitter

PREPARATIONS BEFORE OPERATION

Connect to a Mobile Amplifier Turn off all the equipment before connections.

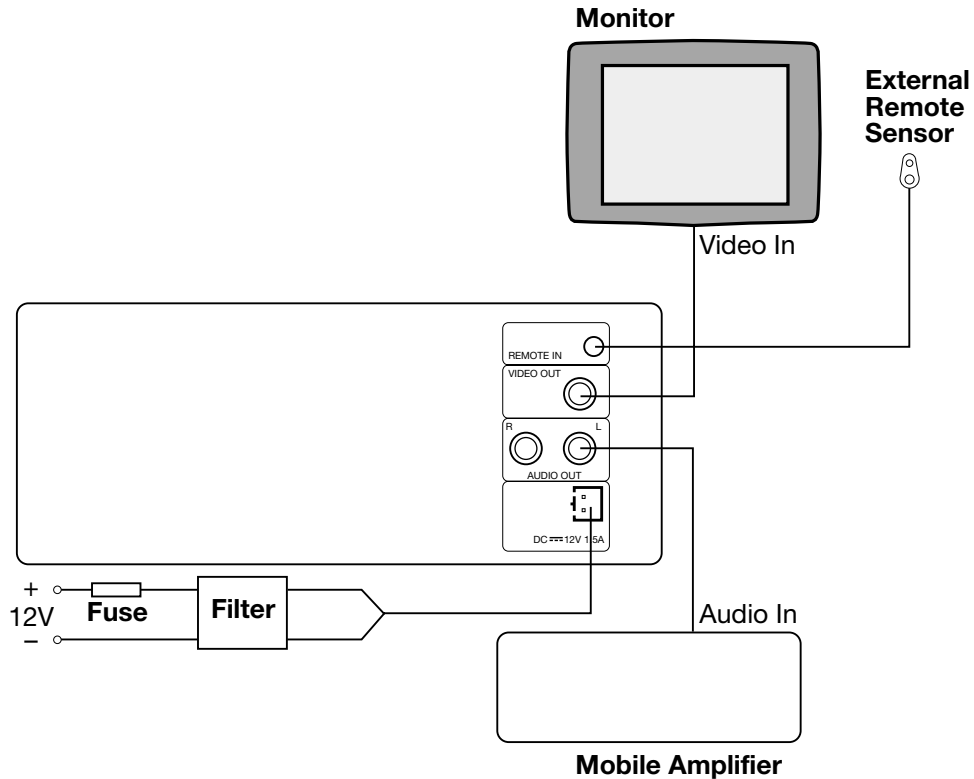

In the connection diagram, the system's power leads should be connected at the same point to minimize noise.

Connect to a TravelPilot DX-N Navigation System Turn off all the equipment before connections.

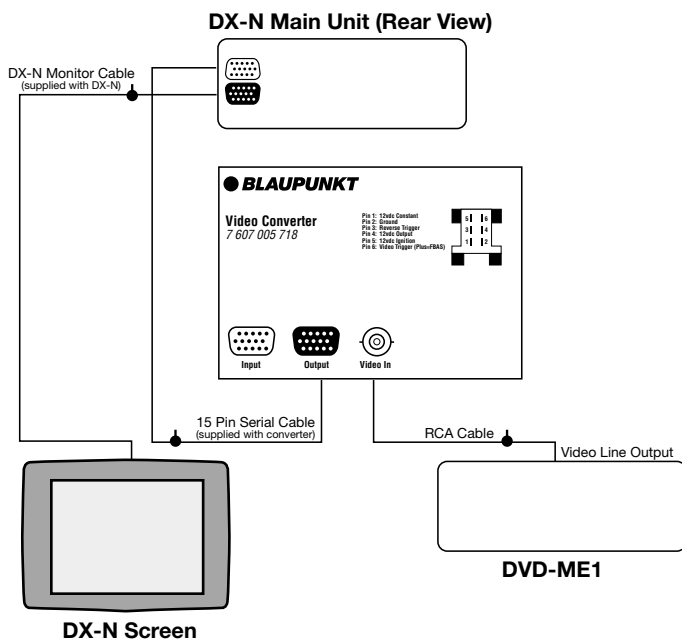

- This schematic describes the installation of an After Market video source, such as VCR, DVD, TV Tuner, or Video Game, connected to a Blaupunkt DX-N Navigation System through a Blaupunkt Video Converter, P/N 7 607 005 718. The Video Converter is necessary to convert the source's video signal into a usable format for the DX-N.
- Signal connections include: (a) RCA connection from the video source's output to the converter's input, (b) 15 pin serial connection between the converter's output and the DX-N ROM 15 pin input, and (c) DX-N ROM connection to the DX-N screen, using the supplied video cable.
- Note: When using a gooseneck mounting adapter, P/N 7 612 001 204, the supplied cable will take the place of the DX-N monitor cable supplied with the DX-N package.
- Note: Video source audio connection can be made via RF modulator to any factory radio or via RCA cable through an After Market radio if an auxiliary input is available.

PREPARATIONS BEFORE OPERATION

Connect to a TV/Monitor Turn off all the equipment before connections.

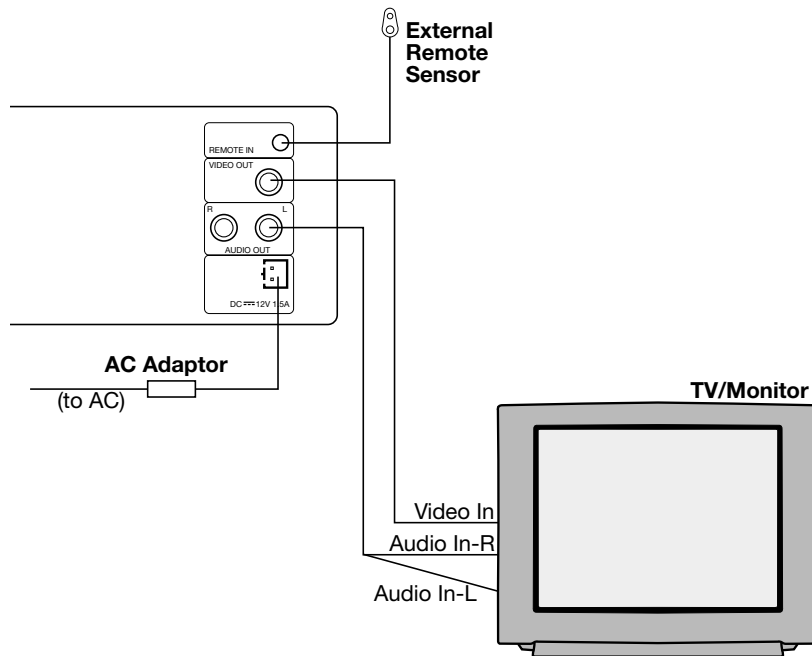

Set the unit. You have to set the unit according to the TV/monitor to be connected.

- If the system of the TV/monitor is PAL, push **[SYSTEM]** and select PAL.
- If the system of the TV/monitor is NTSC, push **[SYSTEM]** and select NTSC.
- If the system of the TV/monitor is AUTO (multi-system), push **[SYSTEM]** and select AUTO.
- Connect the unit to a wide-screen TV. Set the "TV Display" to "16:9 WIDE" in the function setting column.
- Connect the unit to an ordinary TV. Set the "TV Display" to "4:3/PS" or "4:3/LB" in the function setting column.

CONNECT TO AC ADAPTOR (supplied)
1. Connect the output terminal of the AC adaptor to DC IN jack of this unit.
2. Connect the other plug to AC power source.

If you want to enjoy the music by yourself, please connect the headphone (not supplied) to the jack on the front panel.

Connect to an Ordinary Home Amplifier Turn off all the equipment before connections.

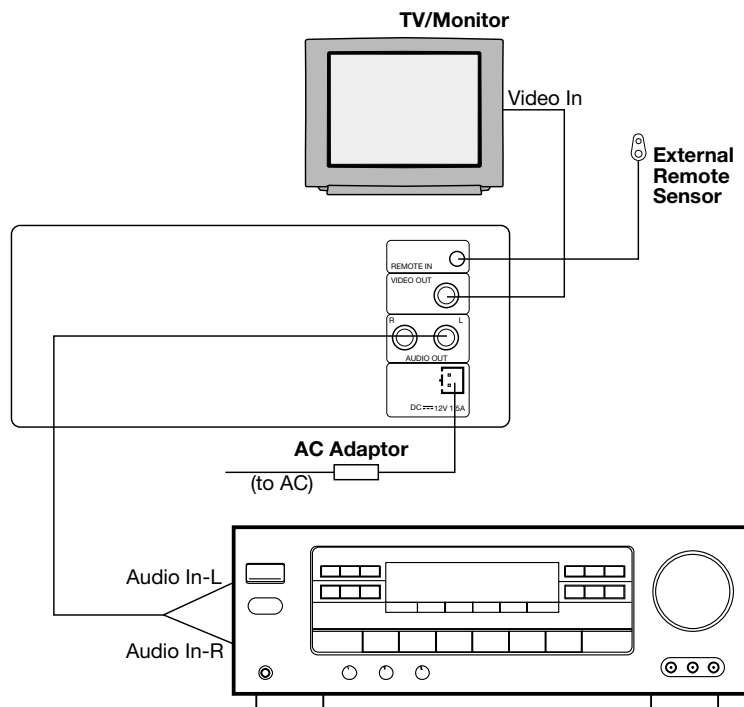

There is no sound output from the output terminal when a DTS disc is played.

BASIC OPERATIONS

TV/Video Selection

Press POWER on the TV and audio system.

1. Press "TV/VIDEO" on the TV/monitor, select VIDEO mode.

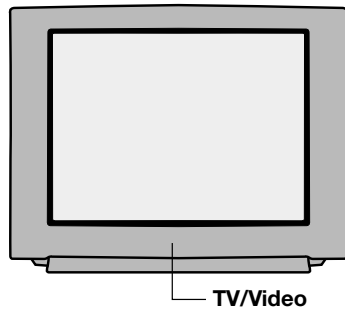

2. Select the correct audio input for your system.

■ Each amplifier is different from another, please refer to the manual of the amplifier. (e.g., connect the audio output of the DVD player to the DVD audio input of an amplifier.)

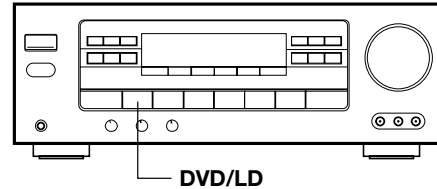

Note: this step can be cancelled if you are utilizing the auxiliary input of a Blaupunkt receiver.

Play Discs



1. Press [POWER] to turn on the unit.

Front Panel

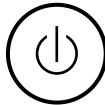

2. Press ▲ to open the disc tray and load a disc with the label side up.

Open/Close

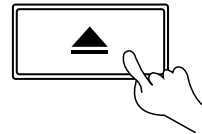

3. Press ▲ again to close the disc tray. The unit begins to read the disc.

Front Panel

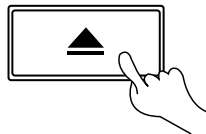

4. Press ► (PLAY) to play the disc.

AFTER STEP 4 IS FINISHED:

- PLAY DVD
The TV screen shows DVD menu or title menu.
- PLAY CD
Press ► (PLAY), the unit plays the disc according to the track numbers.

5. Stop playback. Press ■



6. Remove the disc and turn off the power. You have to push this button twice to stop playback of a DVD disc.

System Settings



According to the system of the TV/monitor, set the system of the unit to make it match the TV/monitor.

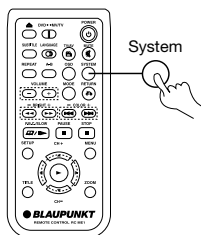

1. If the system of the TV/monitor is PAL: Press [SYSTEM], select PAL. The screen shows:

PAL

2. If the system of the TV/monitor is NTSC: Press [SYSTEM], select NTSC. The screen shows:

NTSC

Pause

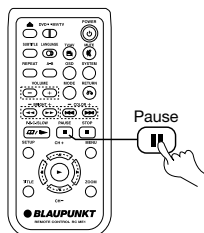

WHEN PLAYING PICTURES

If the pictures of DVD are played, press || to make playback pause. The unit enters step play status. Each time you press ||, the picture advances one frame.

STEP

WHEN PLAYING MUSIC CD
Press || to make playback pause.
Press ► (PLAY) to resume playback.

BASIC OPERATIONS

OSD (On-Screen Display) DVD CD

When the OSD is pressed, the TV/monitor screen shows the operation functions and information about the disc.

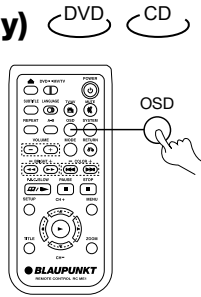

Press **OSD** to select:



Volume Control DVD CD

- Press **VOLUME** on the TV/monitor or amplifier to adjust the volume.
- Press **VOLUME** on the remote control.

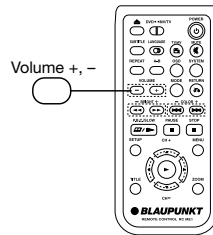

1. Press + to raise the volume.

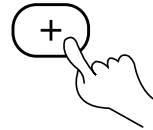

2. Press - to lower the volume.

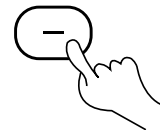

DVD Menu Play DVD

Some DVD's have title menus and chapter menus. Press **▶** (PLAY), the screen shows the menu. Press **▶▶** or **◀◀** to skip the next or previous page, select with direction buttons.

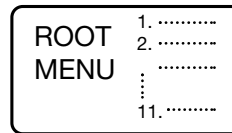

Example: select track 13.

1. Press **▼** to select track 13.

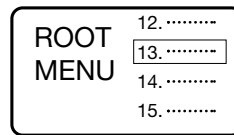
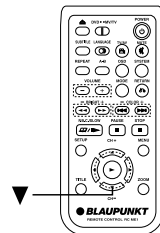

2. Press **▶** (PLAY) to start playing track 13.

Press **TITLE** once to return to the title menu. Press **MENU** once to return to the root menu; press it again to return to the current playback.

Audio Mode DVD CD

- You may select a needed language from a multi-language DVD.
- You may select the right channel or left channel or stereo from a multi-channel CD.

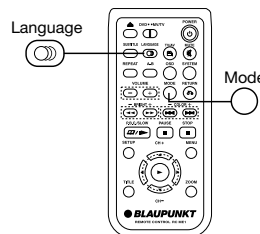

PLAY DISCS IN VARIOUS WAYS

WHEN PLAYING DVD

Press , the screen shows orderly:

AUDIO 1/2:AC-3 2CH

AUDIO 2/2:AC-3 2CH

Different discs differ in languages.

WHEN PLAYING CD

Mode



MONO L

Mode



MONO R

Mode



STEREO

Mute

When playing a disc, this function can remove the sound.

1. REMOVE SOUND
Press **MUTE**, the screen shows "MUTE".

MUTE

2. RESUME SOUND
Press **MUTE** again, the screen shows "MUTE OFF".

Fast Play

When playing a disc, you may play it forward fast or reverse it fast to find what you want.

1. Press  to play forward fast. Each time you press the button, the screen shows orderly:

- ① FF 2X
- ② FF 4X
- ③ FF 6X
- ④ FF 8X
- ⑤ PLAY

2. Press  to reverse the disc fast. Each time you press the button, the screen shows orderly:

- ① FR 2X
- ② FR 4X
- ③ FR 6X
- ④ FR 8X
- ⑤ PLAY

3. Press  (PLAY) to switch to normal play while FF or FR playing.

Slow Play

Enjoy slow motions by the following steps.

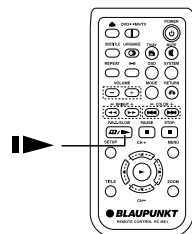

1. Press  to play slowly.

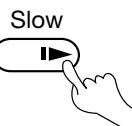

The screen shows orderly:

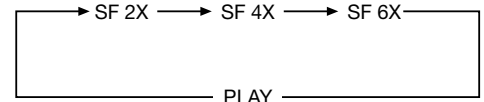

2. Press  (PLAY) to play normally.

PLAY DISCS IN VARIOUS WAYS

Repeat Play

This function can be used to repeatedly play a title, chapter, track, disc, or some part on a disc.

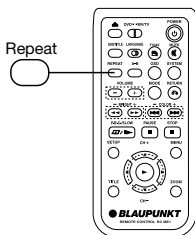

DVD

You may repeat a title or chapter.

1. Repeat a chapter.
Press **REPEAT**, the screen will show:

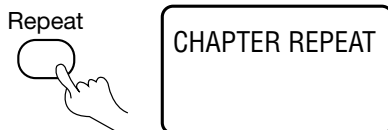

2. Repeat a title.
Press **REPEAT** twice, the screen will show:



3. Remove "REPEAT" function.
Press REPEAT until "TITLE REPEAT" disappeared.

CD

You may repeat a track, a disc according to the following steps.
CD can play repeatedly directly.

1. Repeat a track.
Press **REPEAT**, the screen shows "REPEAT ONE". The unit plays the current track.



2. Repeat a disc.
Press **REPEAT**, the screen shows "REPEAT ALL". The unit plays all the tracks on the disc.

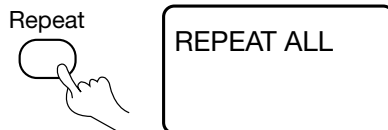

3. Remove "REPEAT" function.
Press **REPEAT** till "REPEAT OFF" displayed on TV screen.

REPEAT SOME PARTS

You may press **A-B** to enjoy some parts repeatedly when playing a disc.

PLAY DVD, CD.

1. Set a starting point A.

The screen shows:



2. Set an end point B.

The screen shows:



Afterwards, the unit plays from A to B.

3. Press **REPEAT** again until "REPEAT AB" disappeared.

Select Subtitles

This operation works only with discs on which multiple subtitle language are recorded.

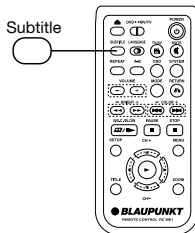

PLAY DVD

1. Press **SUBTITLE** repeatedly until the desired language is selected.
The screen shows:

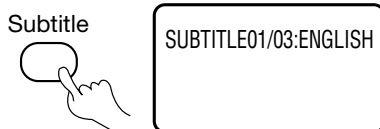

2. Remove the subtitle.
Press **SUBTITLE** until the screen shows "SUBTITLE OFF".

Notes:

- For some discs, subtitles can not be removed.
- Different discs differ in the language of subtitles.
- If the subtitles of discs can not be selected, press SUBTITLE, the screen shows "NO SUBTITLE".

PLAY DISCS IN VARIOUS WAYS

Select Angles

Some discs have images with different viewing angles, you may select among them. For example, when you watch a running train, you may watch it from the front the left window or the right window without stopping it.

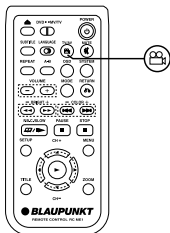

Example:
A DVD has four viewing angles at your option.

1. Press  to select ANGLE 1.

Screen

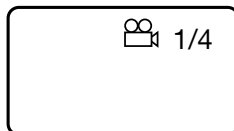

2. Press  to select other angles, the screen shows respectively:

 2/4 (select ANGLE2)

 3/4 (select ANGLE3)

 4/4 (select ANGLE4)

3. To resume normal playback, press  to select original angle.

Zoom Play

This function can be used to watch a motion or motionless picture.

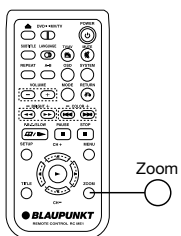

DVD

1. Press **ZOOM** during playback, the screen shows:

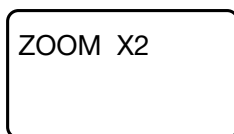

The picture is enlarged twice the size.

3. Push , , ,  to move the enlarged picture.

2. Press **ZOOM** again, the screen shows:

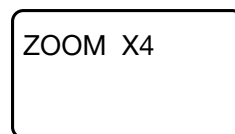

The picture is enlarged four times the size.

4. To resume the picture, push **ZOOM** until the screen shows "ZOOM OFF".

FUNCTION SETTING

Menu Setting

According to the recorded information and external equipment, set the following functions for the player to obtain the best playing status.

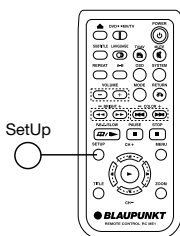





1. Press **SETUP** to set the main menu.

Setup

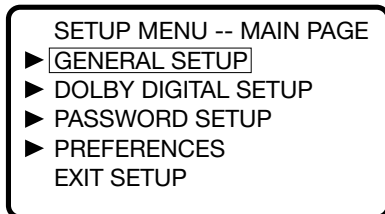

The screen shows:





2. Press direction buttons (, ) to select and press  (PLAY) to confirm.

Example:
Select "DOLBY DIGITAL SETUP"

- Press direction button  to select.

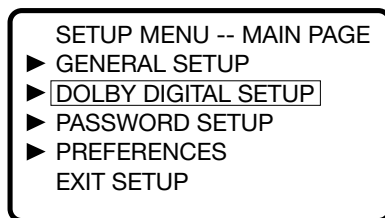
The screen shows:



- Press  (PLAY) to confirm and enter "DOLBY DIGITAL SETUP". The screen shows the submenu for your selection.

The screen shows:

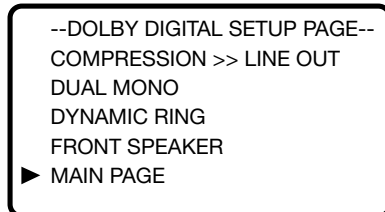



After Entering the menu, the unit automatically selects a column.

- Press the directional button  to select "DUAL MONO".

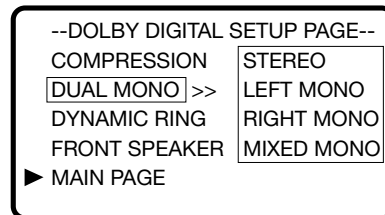
The screen shows:



- Press direction button ,  to select "LEFT MONO"

The screen shows:

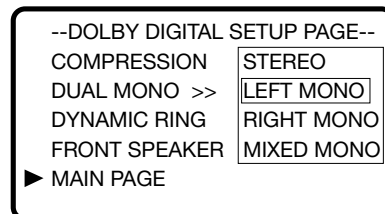

- Press  (PLAY) to confirm selection.



Set "DUAL MONO" in "DOLBY DIGITAL SETUP" to "LEFT MONO".

FUNCTION SETTING

3. Exit from menus.

- Press direction buttons and ► (PLAY) to select the relevant exit column.
- Press the direction buttons ▲, ► to exit from "DUAL MONO".
- Press the direction button ▼ to select "MAIN PAGE", press ► (PLAY) to exit from the current column and return to the main menu.

The screen shows:

The screen shows:

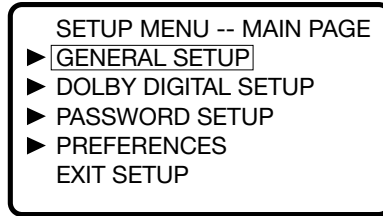

- Press ▲, ▼ to select "EXIT SETUP", then press ► (PLAY) to exit from the menu setting.

GENERAL SETUP

The setting structure is as follows:

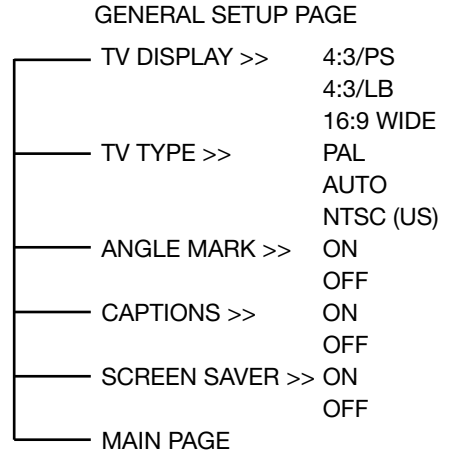

TV Display

1. 4:3/PS

This is selected when the unit is connected to a normal TV. Wide-screen images are shown on the screen, but with some parts cut automatically.



2. 4:3/LB

This is selected when the unit is connected to a normal TV. Wide-screen images are shown on the screen, with black belt on the top and bottom.



3. 16:9 WIDE

This is selected when the unit is connected to a wide-screen TV.



TV Type

You may select according to the color system of the TV/monitor to be connected.

- Select "AUTO" for a multi-system TV/monitor.
- Select "NTSC" for ra NTSC TV/monitor. (US)
- Select "PAL" for a PAL TV/monitor.

Angle Mark

This only works when there is an angle mark on the disc.

- Select "ON", the screen shows the mark when playing DVD.
- Select "OFF", the mark is not shown.

Captions

- ON
The hidden subtitle is shown.
- OFF
The hidden subtitle is turned off.

Screen Saver

Start the screen saver, the screen saver image appears when the unit stops or the image is frozen for a few minutes. This saver can keep the screen from being damaged.

- ON: Start the screen saver.
- OFF: Remove the screen saver.

DOLBY DIGITAL SETUP

The setting structure is:

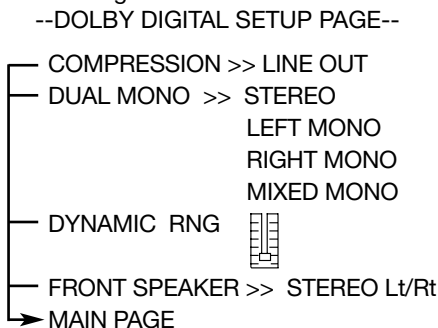

Compression

- LINE OUT: Compress input signals linearly.

Dual Mono

This is the output mode of the L and R signals of the set audio output. If it is set to "MIXED MONO", the function only works when the DVD being played is 5.1 channel.

Dynamic Range

When the compression mode is set to "LINE OUT", this is selected to adjust linear compression rate to obtain the different compression results of the signals.

Front Speaker

- STEREO Lt/Rt
Select this when you play a disc with dolby Pro Logic stereo, the disc signals can be decoded by the unit and be reproduced the realistic theater effects in your room.
- STEREO
Select this, the audio output is produced as an ordinary stereo signals.

FUNCTION SETTING

Password SetUp

The setting structure is:

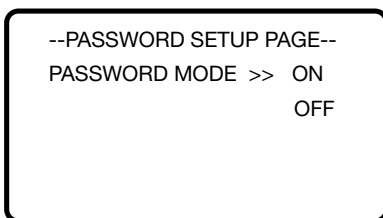

■ PASSWORD MODE

- ON: The password works, "PREFERENCES" is dim and can not be selected.
- OFF: The password is locked, "PREFERENCES" can be selected.

Enter the password according to the screen.

Note: The factory set password is: next symbol, next symbol, next symbol, next symbol, next symbol (press next button 5 times).

Preferences

The setting structure is:

AUDIO >>	ENGLISH FRENCH SPANISH CHINESE JAPANESE
SUBTITLE >>	ENGLISH FRENCH SPANISH CHINESE JAPANESE OFF
DISC MENU >>	ENGLISH CHINESE FRENCH SPANISH JAPANESE
COUNTRY >>	CHINA FRANCE HONG-KONG JAPAN TAIWAN GBR USA
PARENTAL >>	1. KID SAFE 2. G 3. PG 4. PG 13 5. 6. PG-R 7. NC-17 8. ADULT
DEFAULTS >>	RESET

■ LANGUAGE SELECTION

If a language mentioned above is recorded on the disc, you can select sounds, subtitle or disc menu languages. If not, the language recorded on the disc is shown.

■ PARENTAL LOCK

When playing the disc with parental lock function, you may select an age control grade according to to grade of disc and your desire.

Example: Select "PG", you cannot play DVD video disc rated higher than the PG grade. Parental control grades are listed from high to low, kids is the highest grade, adults is lowest grade.

■ DEFAULT >> RESET

Each function setting returns to the initial status in the factory if you select this option.

Note:

- "PREFERENCES" only can be selected password OFF after the unit goes into stop mode.

MP3 OPERATIONS

Play Discs

MP3 is an audio compression mode which adopts the Layer 3 in international standard MPEG. It compresses audio signals with a ratio of 12:1. With MP3, a disc may record over 600 minutes of music or 170 songs, but the sound quality is as good as a CD.

Note: 128 kbps or higher only.

SELECT TRACKS WITH MENUS

1. Load a disc, the screen shows the home menu after the unit finishes the search.

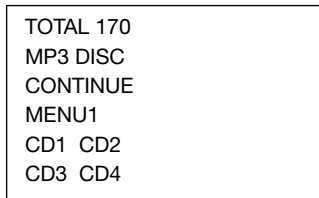

If the menu is shown on different pages, the screen shows ◀◀ or ▶▶ to instruct you to look at the next or previous page.

2. Select the content of the home menu.

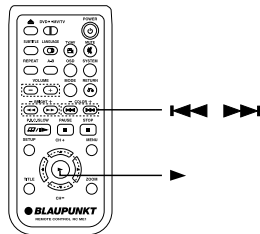

Press ◀◀ or ▶▶ to select (if you select CD3), the screen shows:

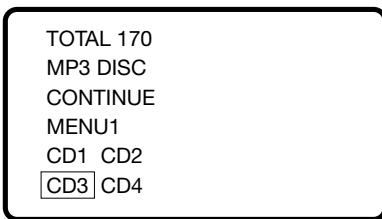

Press ▶ (PLAY) to enter the sub-menu.

3. Press ◀◀ or ▶▶ to select tracks according to the sub-menu.

Example: Select track 2 on CD3. (The 80th song on the disc.)

The screen shows:

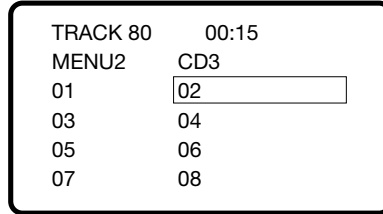

The unit will play the tracks you selected a few seconds later.

4. Press RETURN to return to the home menu.

Repeat Play

You may use repeat function to enjoy some track.

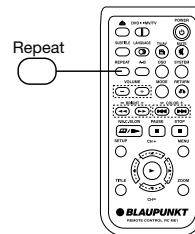

1. Select tracks to play.
2. Press REPEAT until the screen shows "REPEAT ONE".

The screen shows:

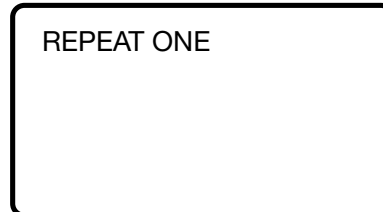

3. Remove repeat function.

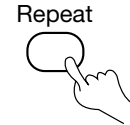

The screen shows:



Other Functions

When playing an MP3 disc, the unit has functions like mute, volume control, pause, previous/ next track, and channel selection. You may operate as you do with a CD.

NOTE on MP3: For high quality sound, we recommend converting MP3 files with sampling frequency of 44.1KHz and a fixed bit rate of 128kbps. Note that the unit may not play tracks in the order that you record them to the disc.

Using Headphone

- Insert the headphone into the PHONE jack.
- Use the VOLUME button on the remote to adjust the volume of the phone.
- When enjoying stories and music using headphone, set the volume to min before playing, then slowly adjust the volume control to suitable location.

Installation Guide

Connect the unit to car mobile DC 12V.

Impending installation

1. Fix the  bracket to the unit with screws.
2. Fix the unit to the car through mounting holes.

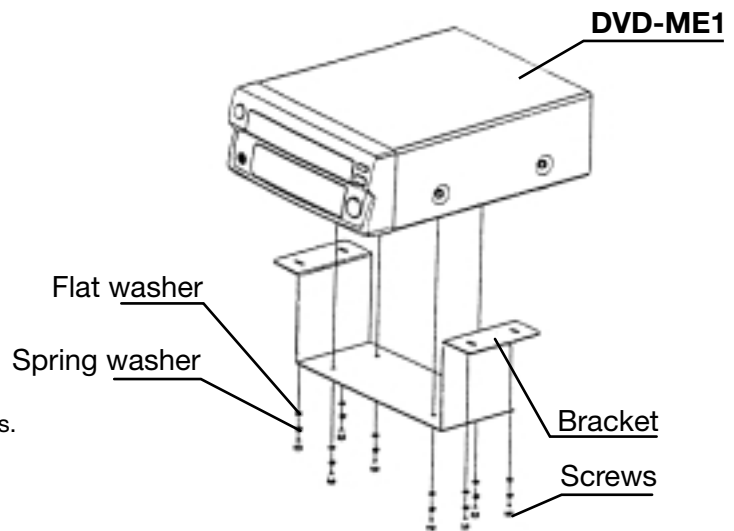

Horizontal placement

1. Fix the  bracket to the unit with screws.
2. Fix the unit to the car through mounting holes.

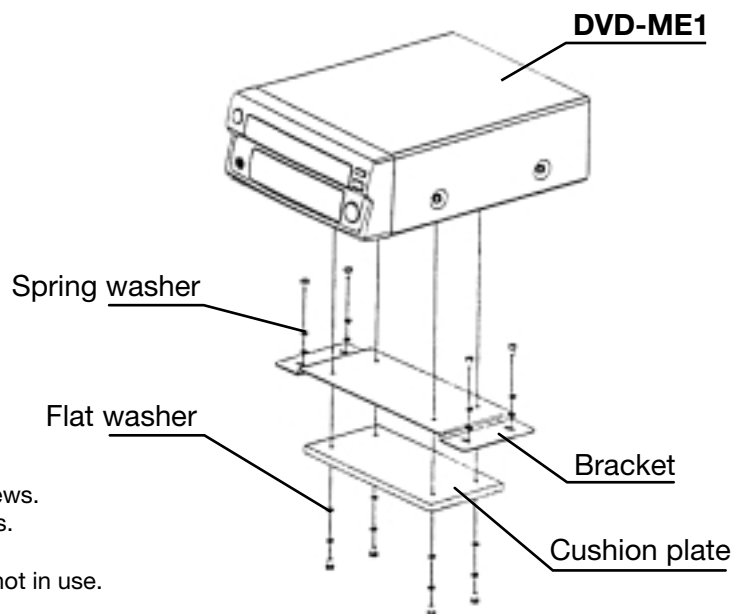

Note: Please remove the disc when the unit is not in use.

LIMITED WARRANTY INFORMATION (UNITED STATES ONLY)

Robert Bosch Corporation warrants new Blaupunkt car audio and video products it distributes in the United States through authorized Blaupunkt dealers, or which are imported as original vehicle equipment by the automobile manufacturer, to be free from defects in material and workmanship, in accordance with the following: For twelve (12) months after delivery to you, the original consumer purchaser, we will repair or at our option replace at no charge to you any car audio and video product which, under normal conditions of use and service, proves to be defective in materials or workmanship. However, this warranty does not cover expenses incurred in the removal or reinstallation of any car audio and video product, whether or not proven defective, and does not cover products not purchased from an authorized Blaupunkt dealer. This warranty is limited to the original consumer purchaser and is not transferable. Repaired and replacement car audio and video products shall assume the identity of the original for purpose of this warranty and this warranty shall not be extended with respect to such products. To obtain performance of this warranty, contact the nearest Blaupunkt authorized repair facility or our nearest office. A dated purchase receipt or other proof that the product is within the warranty period will be required in order to honor your claim. Carefully pack the unit and ship prepaid to the servicing location. For further information, write to the Robert Bosch Corporation, 2800 South 25th Avenue, Broadview, Illinois, 60155, attention Blaupunkt Customer Service Department or call 1-800-266-2528. Specifically excluded from this warranty are failures caused by misuse, neglect, abuse, improper operation or installation, dropping or damaging, unauthorized service or parts, or failure to follow maintenance instructions or perform normal maintenance activities. Normal maintenance activities for car audio and video products include but are not limited to cleaning and other minor maintenance activities and adjustments that are outlined in the owner's manual or that are normally required for continued proper operation. Also excluded from this warranty is the correction of improper installation and the elimination of any external electromagnetic interference. This warranty sets forth your exclusive remedies with respect to the products covered by it. We shall not be liable for any incidental, consequential, special or punitive damages arising from the sale or use of any Blaupunkt car audio and video products, whether such claim is in contract or tort. No attempt to alter, modify, or amend this warranty shall be effective unless authorized in writing by an officer of Robert Bosch Corporation. THIS WARRANTY IS IN LIEU OF ALL OTHER WARRANTIES OR REPRESENTATIONS, EXPRESS OR IMPLIED, INCLUDING ANY WARRANTY IMPLIED BY LAW, WHETHER FOR MERCHANTABILITY OR FITNESS FOR A PARTICULAR PURPOSE OR OTHERWISE AND SHALL BE EFFECTIVE ONLY FOR THE PERIOD THAT THIS EXPRESS WARRANTY IS EFFECTIVE. In the event any provision, or any part or portion of this warranty shall be held invalid, void or otherwise unenforceable, such holding shall not affect the remaining part or portions of that provision or any other provision hereof.

NOTICE TO CALIFORNIA OWNERS: If your Blaupunkt car audio product needs warranty repair service and there is no authorized service center reasonably close to you, you can return the defective unit to the dealer from whom you purchased it, or you can return it to any dealer who sells Blaupunkt car audio and video products. The dealer may, at the dealer's option, replace, repair or refund the purchase price for any Blaupunkt car audio and video products which prove defective under conditions of normal use. If the dealer fails to repair, replace, or partially refund your money, you may take your Blaupunkt car audio and video product to any repair shop and they can repair your unit at our expense unless the repair cost exceeds the depreciated value of the unit, but you must contact Blaupunkt to receive authorization to do this before your car audio and video product is repaired.

ROBERT BOSCH CORPORATION
BLAUPUNKT CUSTOMER SERVICE
2800 SOUTH 25TH AVENUE
BROADVIEW, IL 60155
TEL: 1-800-266-2528

BLAUPUNKT TECHNICAL SUPPORT

This player is designed to install quickly and easily into most vehicles. Should you experience installation problems, we will make all reasonable efforts to help you, the end purchaser or Installation Technician, to competently install these components. Before calling us please carefully review this owners manual for the answers to your questions. Should you need navigation system tech support, please refer to www.blaupunktusa.com before picking up the phone. In case, you need individual assistance, please call 1-800-266-2528 from 9AM to 4 PM (CST).



Robert Bosch Corporation
Sales Group - Blaupunkt Division
2800 S. 25th Avenue, Broadview, Illinois 60155 U.S.A.
www.blaupunktusa.com