



INSTRUCTION MANUAL

**MBR-1404G
MBR-1404GR**

Blood Bank Refrigerator



MBR-1404GR

Note:

1. No part of this manual may be reproduced in any form without the expressed written permission of SANYO.
2. The contents of this manual are subject to change without notice.
3. Please contact SANYO if any point in this manual is unclear or if there are any inaccuracies.

SANYO Electric Biomedical Co., Ltd. All rights reserved. Printed in Japan.

CONTENTS

PRECAUTIONS FOR SAFE OPERATION	P. 2
CAUTIONS FOR USAGE	P. 7
ENVIRONMENTAL CONDITIONS	P. 8
REFRIGERATOR COMPONENTS	P. 9
INSTALLATION	P. 13
BEFORE COMMENCING OPERATION	P. 15
REMOTE ALARM TERMINAL	P. 15
START-UP OF UNIT	P. 16
OPERATING INSTRUCTIONS	P. 17
ROUTINE MAINTENANCE	P. 19
TROUBLESHOOTING	P. 22
DISPOSAL OF UNIT	P. 22
SPECIFICATIONS	P. 23
PERFORMANCE	P. 23
SAFETY CHECK SHEET	P. 24

PRECAUTIONS FOR SAFE OPERATION

It is imperative that the user complies with this manual as it contains important safety advice.

Items and procedures are described so that you can use this unit correctly and safely. If the precautions advised are followed, this will prevent possible injury to the user and any other person.

Precautions are illustrated in the following way:

WARNING

Failure to observe WARNING signs could result in a hazard to personnel possibly resulting in serious injury or death.

CAUTION

Failure to observe CAUTION signs could result in injury to personnel and damage to the unit and associated property.

Symbol shows;

 this symbol means caution.

 this symbol means an action is prohibited.

 this symbol means an instruction must be followed.

Be sure to keep this manual in a place accessible to users of this unit.

< Label on the unit >

















This mark is labeled on the cover in which the electrical components of high voltage are enclosed to prevent the electric shock.

The cover should be removed by a qualified engineer or a service personnel only.











PRECAUTIONS FOR SAFE OPERATION

WARNING

-  **Do not use the unit outdoors.** Current leakage or electric shock may result if the unit is exposed to rain water.
-  **Only qualified engineers or service personnel should install the unit.** The installation by unqualified personnel may cause electric shock or fire.
-  **Install the unit on a sturdy floor.** If the floor is not strong enough or the installation site is not adequate, this may result in injury from the unit falling or tipping over.
-  **Never install the unit in a humid place or a place where it is likely to be splashed by water.** Deterioration of the insulation may result which could cause current leakage or electric shock.
-  **Never install the unit in a flammable or volatile location.** This may cause explosion or fire.
-  **Never install the unit where acid or corrosive gases are present** as current leakage or electric shock may result due to corrosion.
-  **Use a dedicated power source** as indicated on the rating label attached to the unit. **Ensure that a suitable fuse of adequate amperage is used to allow for compressor start up.**
-  **Remove dust from the power supply plug** before inserting in a power source. A dusty plug or improper insertion may pose a hazard.
-  **Use a power supply outlet with ground (earth)** to prevent electric shock. If the power supply outlet is not grounded, it will be necessary to install a ground by qualified engineers.
-  **Never ground the unit through a gas pipe, water main, telephone line or lightning rod.** Such grounding may cause electric shock in the case of an incomplete circuit.
-  **Do not insert metal objects such as a pin or a wire into any vent, gap or any outlet** for inner air circulation. This may cause electric shock or injury by accidental contact with moving parts.
-  **Never store volatile or flammable substances** in this unit. This may cause explosion or fire.
-  **Never store corrosive substances** in this unit. This may lead to damage to the inner components or electric parts.
-  **Do not pull out more than 2 drawers (for MBR-1404GR) at the same time** when storing or taking out of the stocked material. This may cause injury by falling or tipping of the unit if something heavy items are stored.















PRECAUTIONS FOR SAFE OPERATION

WARNING

-  **If this unit is to be used for storing poisons, radioactive material or other harmful products, ensure that it is in a safe area.** Failure to do so may lead to an adverse effect on the health of personnel in the area and the local environment. In this case, a request for repair or maintenance will necessitate a safety check sheet for maintenance personnel.
-  **Disconnect the power supply to the unit prior to any repair or maintenance** of the unit in order to prevent electric shock or injury.
-  **Ensure you do not inhale or consume medication or aerosols** from around the unit at the time of maintenance. These may be harmful to your health.
-  **Never splash water directly onto the unit** as this may cause electric shock or short circuit.
-  **Never disassemble, repair, or modify the unit yourself.** Any such work carried out by an unauthorized person may result in fire or injury due to a malfunction.
-  **Disconnect the power supply plug before replacement of the florescent light** to prevent electric shock.
-  **Disconnect the power supply plug if there is something wrong with the unit.** Continued abnormal operation may cause electric shock or fire.
-  **If the unit is to be stored unused in an unsupervised area for an extended period, ensure that children do not have access and that doors cannot be closed completely.**
-  **The disposal of the unit should be undertaken by appropriate personnel. Remove doors** to prevent accidents such as suffocation.
-  **Prepare a safety check sheet** when you request any repair or maintenance for the safety of service personnel.





PRECAUTIONS FOR SAFE OPERATION

CAUTION

-  **Select a level and sturdy floor for installation.** This precaution will prevent the unit from tipping. Improper installation may result in water spillage or injury from the unit tipping over.
-  **Do not install the unit at a place with the possibility of something falling on it.** The electric parts are located in the upper part of this unit.
-  **Connect the unit to a power source as indicated on the rating label attached to the unit.** Use of any other voltage or frequency other than that on the rating label may cause fire or electric shock.
-  **Fix the shelves securely.** Incomplete installation may cause injury or damage.
-  **When removing the plug from the power supply outlet, grip the power supply plug, not the cord.** Pulling the cord may result in electric shock or fire by short circuit.
-  **Never damage or break the power supply plug or cord. Do not use the supply plug if its cord is loose.** This may cause fire or electric shock.
-  **Do not touch any electrical parts** such as the power supply plug or any switches with a wet hand. This may cause electric shock.
-  **Do not put a container with water or heavy articles on the unit.** Injury may be caused if the articles fall. Current leakage or electric shock may result from the introduction of spilled water into electrical components.
-  **Do not climb onto the unit.** This may cause damage to the unit and cause it to tip over.
-  **Hold the handle when closing the door.** This will reduce the likelihood of a trapped finger.
-  **Do not lean on the door.** This may cause injury if the unit tips over.
-  **Never lean or press on the glass.** Excessive force may cause injury if the glass breaks.
-  **Check the filter mentioned in this manual and clean it as necessary.** A dusty filter may cause temperature rise or failure.
-  **Do not touch the condenser directly** when the filter is removed for cleaning. This may cause injury due to hot surface.
-  **Disconnect the power supply plug** before moving the unit. Take care not to damage the power cord. A damaged cord may cause electric shock or fire.

PRECAUTIONS FOR SAFE OPERATION

CAUTION

-  **Dispose of any water in the evaporation tray completely before moving the unit.** Spilled or splashed water may cause current leakage or electric shock.
-  **Be careful not to tip the unit over** during movement to prevent damage or injury.
-  **Disconnect the power plug** when the unit is not used for long periods.
-  **Do not put the packing plastic bag used in the packaging within reach of children** as suffocation may result

CAUTIONS FOR USAGE

1. Adequate space should be provided between the items inside the unit to allow air circulation.
2. Never store corrosive materials such as acid or alkali unless the container is completely sealed up. Corrosion may lead to failure of the unit in time.
3. In case condensation forms on the front glass or frame due to a high humidity environment, wipe it off with a soft and dry cloth.
4. Do not clean the unit with scrubbing brushes, acid, thinner, solvents powdered soap, cleanser or hot water. These agents can scratch the paint or cause it to peel. Plastic and rubber parts can be easily damaged by these materials, especially solvents. When a neutral detergent is used to clean the unit, rinse thoroughly with a cloth soaked in clean water.

ENVIRONMENTAL CONDITIONS

This equipment is designed to be safe at least under the following conditions (based on the IEC 1010-1):

1. Indoor use;
2. Altitude up to 2000 m;
3. Ambient temperature 5°C to 40°C
4. Maximum relative humidity 80% for temperature up to 31°C decreasing linearly to 50% relative humidity at 40°C;
5. Mains supply voltage fluctuations not to exceed $\pm 10\%$ of the nominal voltage;
6. Other supply voltage fluctuations as stated by the manufacturer.
7. Transient overvoltages according to Installation Categories (Overvoltage Categories) II; For mains supply the minimum and normal category is II;
8. Pollution degree 2 in accordance with IEC 664.

REFRIGERATOR COMPONENTS

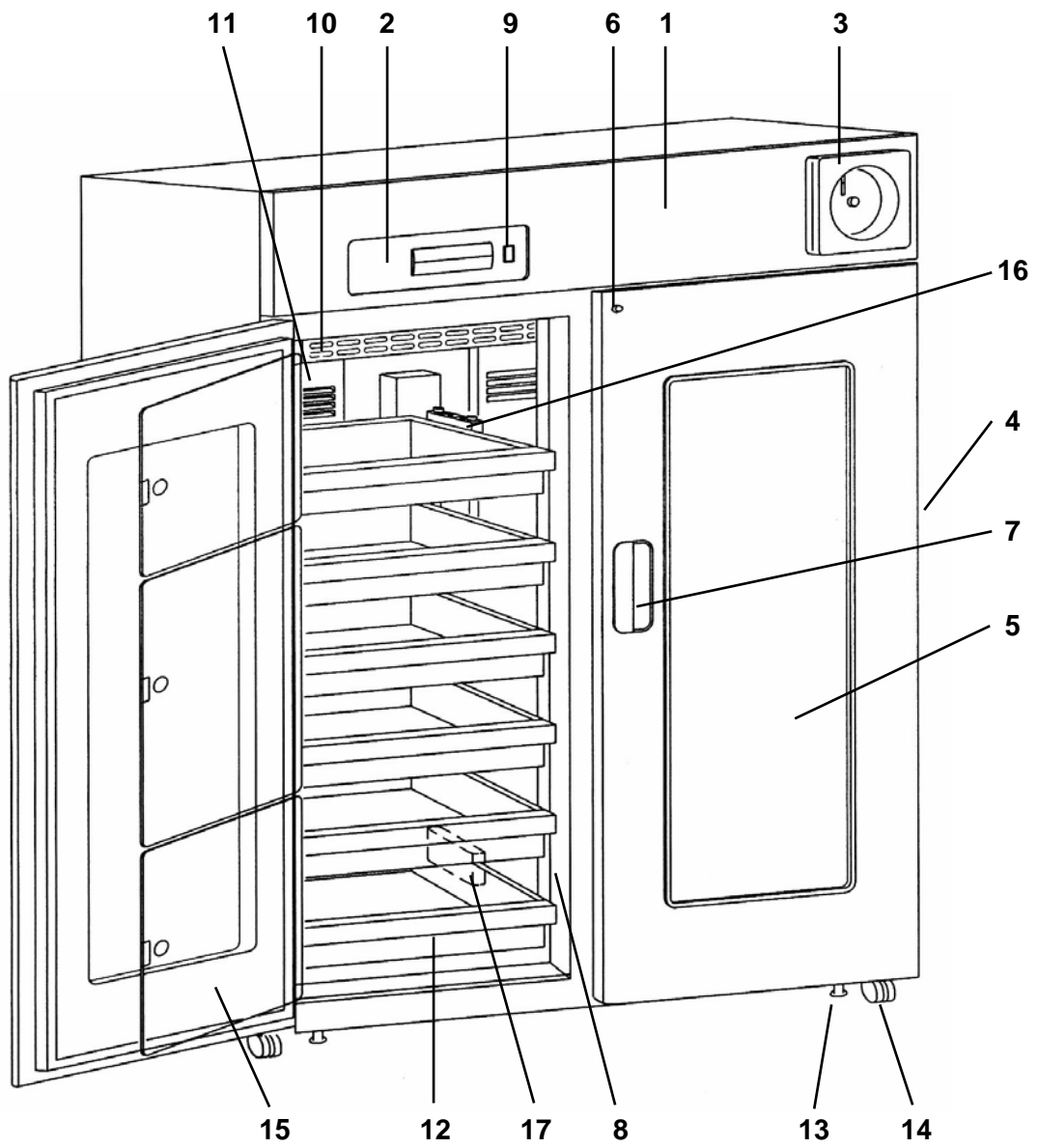

MBR-1404GR

REFRIGERATOR COMPONENTS

- 1. Front cover:** Open this cover to connect to a remote alarm or when cleaning the condenser filter. Refer to page 19.
- 2. Control panel:** Panel opens when the right top of the lower part of the cover is pushed. Refer to page 12.
- 3. Automatic temperature recorder:** A 7-day type recorder is provided. For proper usage of the recorder, see the instruction manual enclosed with the recorder.
- 4. Access port:** This port allows cables to be passed into the cabinet.
- 5. Glass window:** Water will sometimes condense on the glass in areas of high humidity. Wipe off the condensation with a dry soft cloth.
- 6. Lock:** Turn clockwise to 180° with a key and the door can be securely locked.
- 7. Handle:** Use this when opening or closing the door.
- 8. Fluorescent light:** 40 W white light. For the replacement, refer to page 20.
- 9. Light switch:** This switch is used for the fluorescent light.
- 10. Air intake vent:** Ensure this vent is never blocked. Failure to do so will result in unstable temperature distribution.
- 11. Air exhaust vent:** Ensure this vent is never blocked. Failure to do so will result in unstable temperature distribution.
- 12. Drawer (MBR-1404GR):** The items are kept in this drawer. One drawer capacity is about 40 kg.
Shelf (MBR-1404G): The items are kept in this shelf. One shelf capacity is about 40 kg.
Do not put anything on the bottom floor directly. Refer to page 16.
- 13. Leveling foot:** Use this foot to adjust the height and level the unit.
- 14. Caster:** For moving of the unit. At the time of installation, use the leveling foot to ensure that the caster does not touch the floor.
- 15. Inner door**
- 16. Upper monitor bottle**
- 17. Lower monitor bottle**

REFRIGERATOR COMPONENTS

Inside of front cover

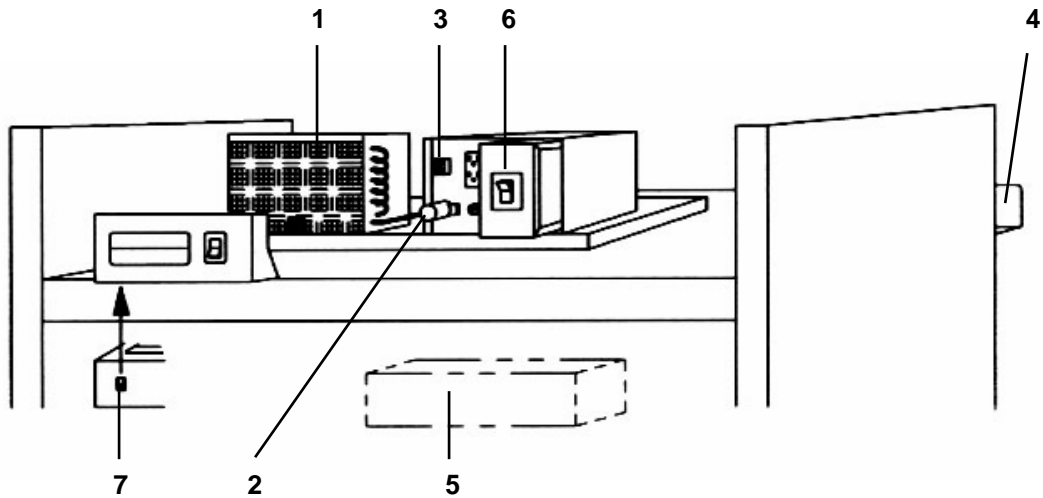

1. Condenser filter: This filter is to prevent dust from plugging the condenser. Please clean the filter once a month.

2. Glow starter: This is for fluorescent light. Use “FG-4P” for replacement.

3. Remote alarm terminal: Refer to page 15.

4. Spacer (rear side): This spacer keeps the unit the proper distance from the wall. This spacer is also available for metal fitting to prevent tipping.

5. Evaporating tray (rear side): This is for evaporation of the drained water from evaporator.

6. Power switch: “ | ”; ON, “ ”; OFF.

7. Battery switch: ON/OFF switch of installed battery for power failure alarm. Make sure to turn on this switch when the unit is in operation.

Note: Turn off the switch to protect the battery when the unit is not used for long periods.

REFRIGERATOR COMPONENTS

Control panel

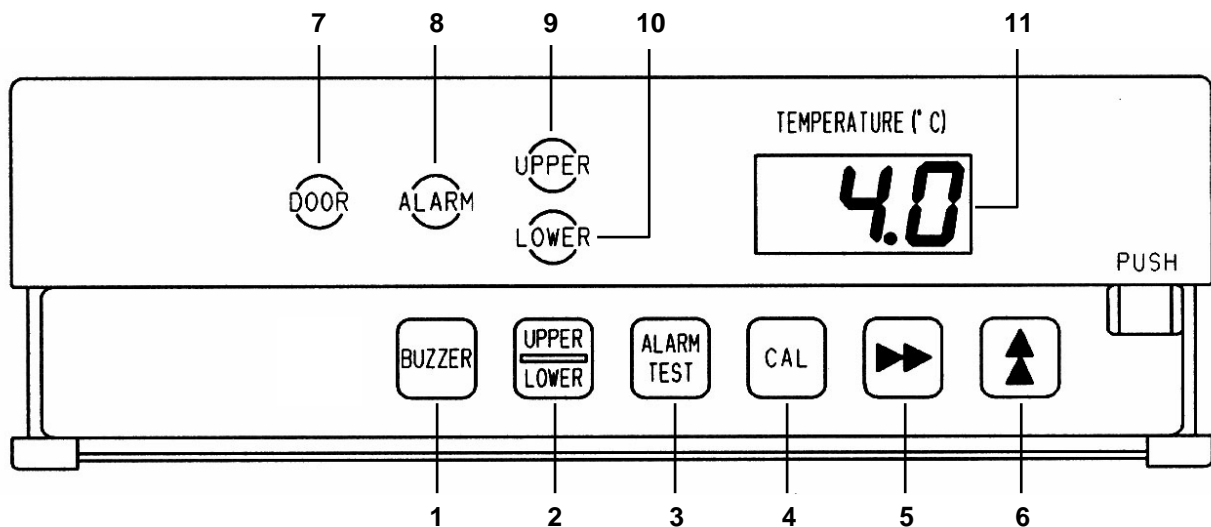

- 1. Alarm buzzer stop key (BUZZER):** Press this key to temporarily silence the buzzer in the event that the alarm operates and buzzer sounds.
- 2. Temperature display (UPPER/LOWER):** By pressing this key, the displayed temperature is changed; upper monitor bottle temperature, lower monitor bottle temperature, and average temperature of upper and lower monitor bottles are displayed in sequence.
- 3. Alarm test key (ALARM TEST):** To check the operation of alarm buzzer, lamp, and remote alarm terminal.
- 4. Calibration key (CAL):** To calibrate the temperature. Normally this key is not used.
- 5. Digit shift key (▶▶):** Pressing this key in the CAL mode will cause the changeable digits to move.
- 6. Numerical value shift key (▲):** Pressing this key in the CAL mode will cause the numerical value to change.
- 7. Door check lamp (DOOR):** This lamp is lit when the door is ajar or open.
- 8. Alarm lamp (ALARM):** This lamp is flashed during alarm condition.
- 9, 10. Temperature display monitor lamp (UPPER, LOWER):** Lamp 9 is lit when upper monitor bottle temperature is displayed. Lamp 10 is lit when lower monitor bottle temperature is displayed. Both 9 and 10 are lit when the average temperature is displayed.
- 11. Digital temperature display (TEMPERATURE °C):** The upper or lower monitor bottle temperature or average temperature is displayed.

INSTALLATION

Installation site

To operate this unit properly and to obtain maximum performance, install the unit in a location with the following conditions:

1. A location not subjected to direct sunlight

Installation in a location subjected to direct sunlight may lead to inadequate cooling.

2. A location with adequate ventilation

Leave at least 10 cm around the unit for ventilation. Poor ventilation will result in a reduction of the refrigeration capacity.

3. A location away from heat generating sources

Avoid installing the unit near heat-emitting appliances such as gas ranges or stoves. Heat can cause inefficient refrigeration.

4. A location with a sturdy and level floor



WARNING

Install the unit on a sturdy floor. If the floor is not strong enough or the installation site is not adequate, this may result in injury from the unit falling or tipping over.

Select a level and sturdy floor for installation. This precaution will prevent the unit from tipping. Improper installation may result in water spillage or injury from the unit tipping over.

5. A location where objects will not fall on the unit



CAUTION

Never install the unit in a place where the possibility exists that an object may fall on it. There are cooling circuits and electric components in the upper part of this unit. Current leakage or electric shock may be caused if an object falls on it.

6. A location without flammable or corrosive gas



WARNING

Never install the unit in a flammable or volatile location. This may cause explosion or fire.

Never install the unit where acid or corrosive gases are present as current leakage or electric shock may result due to corrosion.

7. A location not prone to high humidity



WARNING

Do not use the unit outdoors. Current leakage or electric shock may result if the unit is exposed to rain water.

Never install the unit in a humid place or a place where it is likely to be splashed by water. Deterioration of the insulation may result which could cause current leakage or electric shock.

INSTALLATION

Installation

1. Remove the packaging materials and tapes

Remove all transportation packaging materials and tapes. Open the doors and ventilate the unit. If the outside panels are dirty, clean them with a neutral detergent and wipe it up with a wet cloth.

2. Adjust the leveling foot

Extend the leveling feet by rotating them counterclockwise to contact them to the floor. See Fig. 1. Ensure the unit is level.

3. Fix the unit

Two hooks are attached to the rear of the cabinet. Fix the cabinet to the wall with these hooks and rope or chain.

If holes can be opened on the wall, open a hole with a 10.5 mm diameter and fix the cabinet by using the special bolt-nut supplied with this cabinet. This bolt-nut can be used only on concrete walls. See Fig. 2.

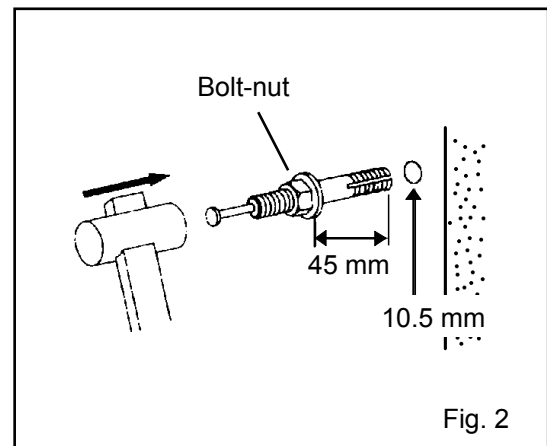
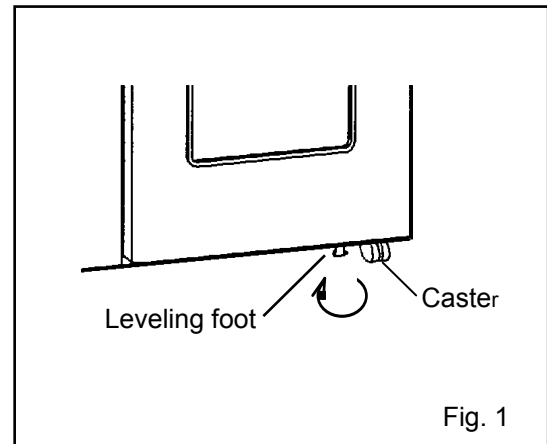

4. Ground (earth)

⚠ WARNING

Use a power supply outlet with ground (earth) to prevent electric shock. If the power supply outlet is not grounded, it is necessary to install a ground by qualified engineers.

Never ground the unit through a gas pipe, water main, telephone line or lightning rod. Such grounding may cause electric shock in the case of an incomplete circuit.

BEFORE COMMENCING OPERATION

Preparation of monitor bottle

Prior to the operation of the unit, fill the monitor bottles (upper and lower) with 10% glycerol (or other solution such as ethylene glycol) by the following procedure:

1. Remove the top and bottom drawer (or shelf).
2. Remove the monitor bottle cover as shown in the figure 1.
3. Detach the sensor from the monitor bottle.
4. To take out the bottle, remove two screws by loosening with hand
5. Pour 200 ml of 10% glycerol (or other solution) into the monitor bottle after removing the cap as shown in the figure 2.
6. Cap the monitor bottle and return the bottle to its original position. Route the lead wire through the hook on the wall.
7. Attach the sensor to the bottle and replace the cover on the bottle.

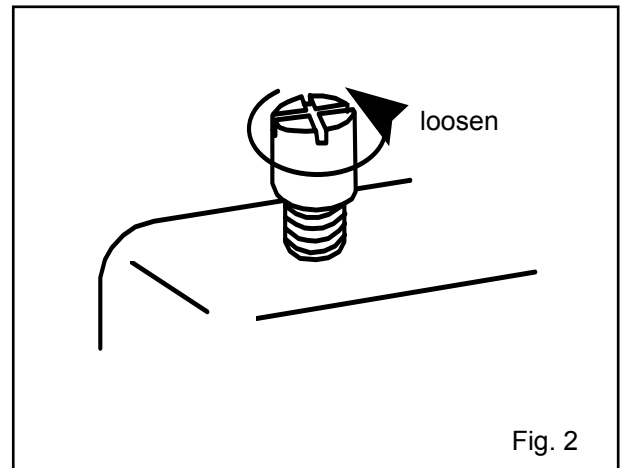
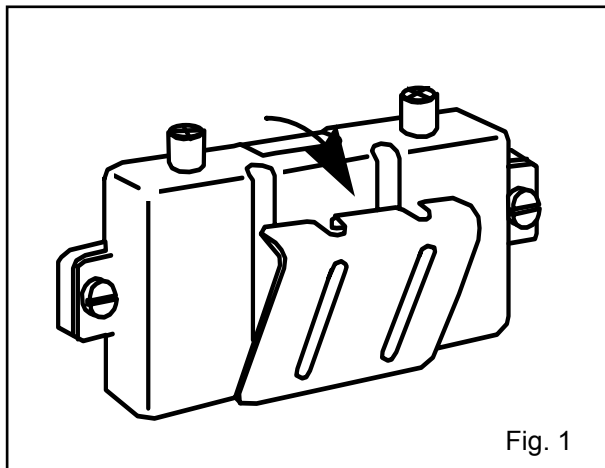

REMOTE ALARM TERMINAL

The terminal of remote alarm is located inside the front cover.

The signal is a dry contact.

Contact capacity is 2A, DC30V.

Output : normal: open
abnormal: closed

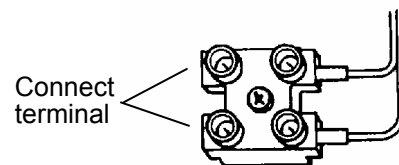

Note: In the state that the power supply plug is disconnected, the remote alarm operates.

Remote alarm can be stopped by pressing alarm buzzer stop key (BUZZER) except for case of power failure.

START-UP OF UNIT

Follow the procedures for the initial and consequent operations of the unit.

1. Connect unit to dedicated power supply. Do not put any product in the unit at this time.
2. When the power is initially applied, the audible alarm may sound. This is normal. Press the BUZZER key to silence the alarm. The audible alarm will operate until the temperature monitor bottle sensor goes into the range of $4^{\circ}\text{C}\pm 2^{\circ}\text{C}$.
3. Ensure that both monitor bottles have been filled with 10% glycerol as outlined earlier in this manual.
4. The unit has been factory preset to operate at $4^{\circ}\text{C}\pm 1.5^{\circ}\text{C}$. There is no need to set the temperature.
5. Proper chamber temperature may take several hours to stabilize at the set point temperature. Once the unit has stabilized, ensure that the monitor bottle temperature agrees with the set point temperature.
6. Turn on the light switch to ensure that the chamber light is properly functional.
7. When you are satisfied that the unit is working correctly, begin slowly placing product into the chamber to minimize the temperature rise.

Handling of containers

Arrange containers so as not to disturb air circulation in the unit. Disturbance of air circulation may cause freezing of contents or increase of temperature.

1. Air intake vent

Avoid the disturbance of air circulation in the unit by containers. Disturbance of air circulation may cause freezing of contents or rise in temperature.

2. Air exhaust vent

Do not block the exhaust air port by putting containers near the exhaust air port. Containers near the exhaust air port may freeze.

3. Load line

This unit determines the range of the containers to ensure proper air circulation. Put containers in range of the label of "Load line" which is attached on both sides inside the unit.

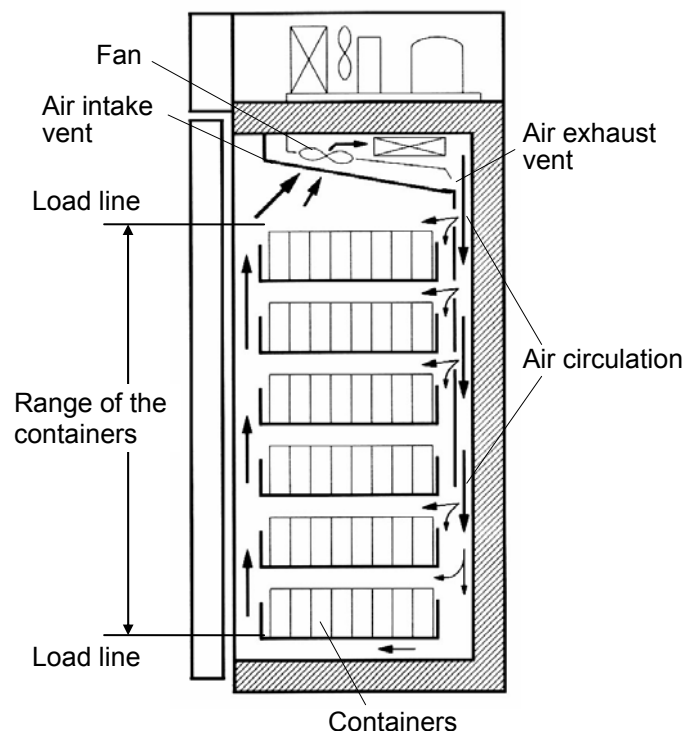

OPERATING INSTRUCTIONS

Temperature display

The unit is set at the factory to obtain the proper temperature automatically ($4^{\circ}\text{C}\pm 1.5^{\circ}\text{C}$). The high temperature alarm is preset at 6°C . The low temperature alarm is preset at 2°C .

Table 1. Temperature display : Lamp ON : Lamp OFF

	Operation	Key operated	Display		Display mode
1	Plug-in, Power ON		Average monitor bottle temperature	UPPER LOWER	Average temperature
2	Press temp. display key	UPPER LOWER	Upper monitor bottle temperature	UPPER LOWER	Upper temperature
3	Press temp. display key	UPPER LOWER	Lower monitor bottle temperature	UPPER LOWER	Lower temperature
4	Press temp. display key	UPPER LOWER	Average monitor bottle temperature	UPPER LOWER	Average temperature
5	Repeat from 2				

Note: The displayed temperature represents the temperature sensed by a thermal sensor attached to the monitor bottles mounted to the upper and lower portion of the chamber. The displayed temperature may not always be at 4°C . The chamber probes are representative and high and low average temperatures within the chamber.

Defrost cycles

There is no need for routine defrosting of the unit as this occurs automatically as follows:

1. Cycle defrost

To keep the temperature stable inside the chamber, the refrigeration compressor is cycled on and off. During “off “ periods any frost which has accumulated on the evaporator is melted by energizing a defrost heater. This will not have any discernible effect on the chamber temperature.

2. Forced defrost

When the ambient humidity is high, or a large amount of damp product is being stored inside the chamber, there is a possibility that cycle defrost may not be enough to remove all of the frost on the evaporator. In this case, a forced defrost cycle can be initiated. When the unit is operating under a forced defrost cycle, the current chamber temperature and dF is displayed alternately on the digital temperature display. Once the forced defrost cycle is complete, normal operation resumes. The chamber temperature of blood bag (400 ml) rises about 1 to 2°C during the defrosting.

OPERATING INSTRUCTIONS

Alarm, safety function, and self diagnostic function

This unit has the alarm and safety functions shown in Table 2, and also self diagnostic function.

Table 2 Alarm and safety functions

Kind of alarm or safety	Situation	Indication	Buzzer	Safety operation
High temperature alarm	If the upper or lower temp. sensor senses a temperature 6°C .	Alarm lamp flashes.	Intermittent tone.	Remote alarm is active.
Low temperature alarm	If the upper or lower temp. sensor senses a temperature 2°C .			
Over-temp. (high) alarm	If the high-temp. thermostat sensor senses a temperature approximately $> 10^{\circ}\text{C}$.	Unit should already be in alarm. No further indication required.	Unit should already be in a high temp. alarm.	Remote alarm is active. Compressor ON. Heater OFF.
Power failure alarm	Interruption of power to unit or power switch is turned off.	Alarm lamp flashes. Temp. indication off.	Intermittent tone.	Remote alarm is active.
Door alarm	Outer door is ajar or open.	Door check lamp is lit.	Intermittent tone after a delay of 2 minutes.	Not affected.
Auto return	No key operation on control panel for 90 seconds.	Monitor bottle temp. is displayed.	----	Calibration mode is canceled.
Thermal sensor abnormality	Upper temperature sensor goes open or short circuit.	Alarm lamp flashes. Monitor bottle temp. E1 are alternately displayed.	Intermittent tone	Remote alarm is active.
	Lower temperature sensor goes open or short circuit.	Alarm lamp flashes. Monitor bottle temp. E2 are alternately displayed.		
	Defrost sensor goes open or short circuit.	Alarm lamp flashes. Monitor bottle temp. E3 are alternately displayed.		
	Over-temp. sensor goes open or short circuit.	Alarm lamp flashes. Monitor bottle temp. E4 are alternately displayed.		

Note: The remote alarm contacts will activate in conjunction with the audible alarm. The remote alarm contacts can be deactivated while pressing the BUZZER key when the unit is in alarm, except in a power failure alarm where the contacts will remain in an alarm condition until the power failure is corrected. All alarm functions will auto-reset. The buzzer and remote contacts will re-activate if the condition which caused the alarm is not corrected within 30 minutes. Alarm conditions will remain active for about 24 hours on a fully charged back-up battery in the event of a power failure. Two days operation is required to fully charge the battery after initial start-up if the power has been off for an extended period. The remote alarm contacts will remain active even if the battery is discharged.

Alarm set procedure

Press the ALARM TEST key. The audible and visual alarm indicators will activate along with the remote alarm contacts. The alarm condition will remain active for 90 seconds and then terminate automatically. Otherwise the alarm test can be terminated manually at any time during the rest by pressing the ALARM TEST key a second time.

ROUTINE MAINTENANCE

⚠ WARNING

Always disconnect the power supply to the unit prior to any repair or maintenance of the unit in order to prevent electric shock or injury.

Ensure you do not inhale or consume medication or aerosols from around the unit at the time of maintenance. These may be harmful to your health.

Cleaning of cabinet

- Clean the unit once a month. Regular cleaning keeps the unit looking new.
- Use a dry cloth to wipe off small amounts of dirt on the outside and inside of the unit and all accessories. If some of them are dirty, use a cloth containing diluted neutral dishwashing detergent (Undiluted detergent may break the plastic parts. For the dilution, follow the instruction enclosed with the detergent). When a diluted neutral dishwashing detergent is used, wipe the cabinet or accessories thoroughly with a cloth soaked in clean water. Then wipe the cabinet or accessories unit with a dry cloth to eliminate the moisture.
- Never pour water onto or into the unit. Doing so can damage the electric shock or short circuit.
- The compressor and other mechanical part are completely sealed. This unit requires absolutely no lubrication. There is a fan behind the compressor, so be very careful if you stick your hand into this part of the unit.

Cleaning of condenser filter

1. Lift front cover by pulling firmly on both lower corners of the panel.
2. Take out the shaft, and insert end of a shaft in black hole of the front cover. This will keep the cover from falling back.
3. Tug gently on black tab on lower center of condenser filter to remove the filter.
4. Clean filter with a vacuum cleaner or water.
5. Thoroughly dry filter if using water to clean it.
6. After cleaning the condenser filter, return it to the original position.

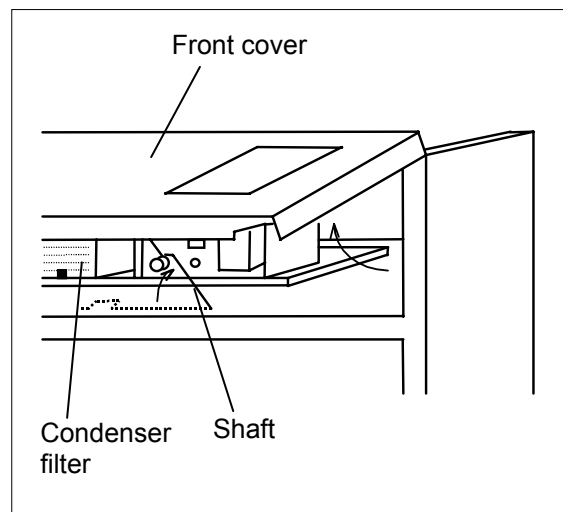

ROUTINE MAINTENANCE

Cleaning of evaporating tray

1. Remove the evaporating tray installed on the back of the frame by lifting the tray.
2. Wash away any accumulated dirt in the evaporating tray.
3. After cleaning of the evaporating tray, return it to the original position.

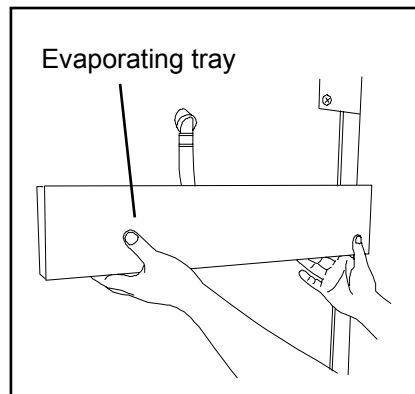

Replacement of fluorescent light

1. The fluorescent light is placed vertically at the center of the frame.
2. Disconnect the power supply plug.
3. When replacing the fluorescent light, remove all shelves or drawers.
4. In the case of MBR-1404GR, after removing all drawers, remove the rail that is placed vertically at the center of the frame.
5. Pull the fluorescent light towards the rear together with the cover, as shown in Fig. 1, together with the wiring.
6. Take out the fluorescent light and remove the connector water-proofing rubber at both ends. As shown in Fig. 2, shift the rubber by rolling it.
7. Remove the connector, as shown in Fig. 3.
8. Next, pull out the fluorescent light. Pull gently from the cover.
9. After replacing the new fluorescent light, return it to the original position.

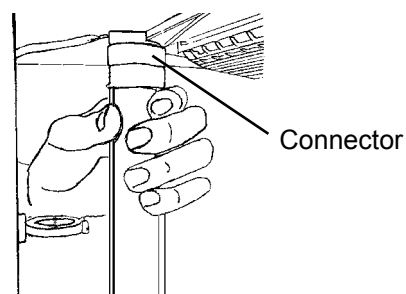

Fig. 1

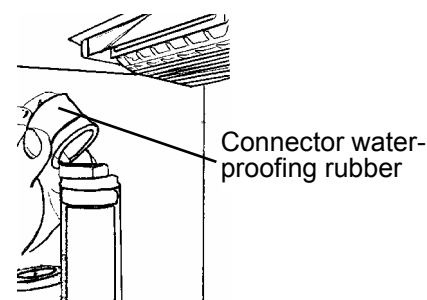

Fig. 2

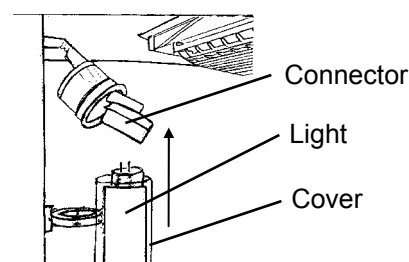

Fig. 3

ROUTINE MAINTENANCE

Calibration of temperature sensor

The temperature sensors are attached to the monitor bottles. Follow the following instructions for proper calibration (zero adjustment):

1. Remove the monitor bottle cover as shown in the figure.

2. Remove the sensor to be calibrated from the monitor bottle. (Please note that model MBR-1404GR also have a sensor for the temperature recorder in the left side of the upper monitor bottle.)

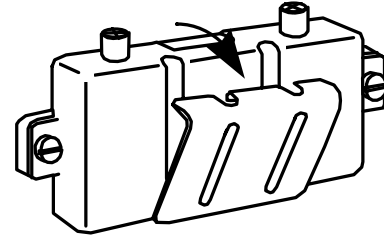

3. Prepare a bottle or beaker with a solution of crushed ice and cold water. Agitate the mixture thoroughly.

4. Put the sensor to be calibrated in the mixture.

5. While continuously agitating the ice water mixture, monitor the temperature indicated on the display of the sensor to be calibrated.

6. Wait for the temperature on the display to stabilize. If the display is not 0°C calibrate using the following procedure. If the display does indicate 0°C proceed to step 7.

1) Press the CAL key for approximately 5 seconds until C00 is displayed.

2) Enter the code of the probe to be calibrated using the numerical shift key. Upper temperature sensor code is C01. Lower temperature sensor code is C02.

3) Press the CAL key. This makes temperature display 0°C.

4) The digital display will revert back to actual chamber temperature. The calibration that was entered in the previous step should now have an effect on the temperature display. The digital display should show now indicate 0.0, if not, repeat step 6.

7. Take the sensor out of the ice water solution and wipe with a soft cloth.

8. Attach the sensor back into the monitor bottle by reversing the procedure in steps 1 and 2.

* For the span adjustment, contact a service personnel.

TROUBLESHOOTING

If the unit malfunctions, check out the following before calling for service.

If nothing operates even when switched on

- There is a power failure.
- The fuse is blown or the circuit breaker is inactivated.
- The unit is not connected to the power supply.

When unit does not get cold enough

- The air exhaust vent is blocked up with containers.
- A large amount of items or warm product was put in the unit.
- There is a nearby heat source.
- The door is frequently opened.
- The ambient temperature is too high.
- The unit is in direct sunlight.
- The door is not securely closed.
- The door seal is damaged or foreign substance is inserted between door gaskets.

The alarm device is activated

When alarm lamp and buzzer are activated, follow the procedures to determine a cause.

<On start-up>

- The temperature in the unit does not match a set value.

<In use>

- The door was kept opened for a long time.
- Containers of high temperature (load) were put in the unit

In these cases, alarm is removed automatically by running the unit for several hours.

DISPOSAL OF UNIT

WARNING

If the unit is to be stored unused in an unsupervised area for an extended period **ensure that children do not have access and doors cannot be closed completely.**

The disposal of the unit should be accomplished by appropriate personnel. Always remove doors to prevent accidents such as suffocation.



This product has an electric battery.

Please recycle it for effective utilization of resources and protection of our environment.

Thank you for your cooperation.

Label indication is obliged to comply with Taiwanese battery regulation.

SPECIFICATIONS

Name	Blood Bank Refrigerator					
Model	MBR-1404G			MBR-1404GR		
External dimensions	W1440 x D830 x H1950 (mm)					
Internal dimensions	W1320 x D697 x H1500 (mm)					
Effective capacity	1287 L					
Exterior	Painted steel					
Interior	Painted steel					
Door	Double layer pair glass/steel plate, Self-closing mechanism, 2 doors					
Insulation	Rigid polyurethane foamed-in place					
Shelf	Hard steel wire on polyethylene coating 12 shelves			-----		
Drawer	-----			Stainless steel, Handle with card holder 12 drawers		
Access port	Left side, right side, Inner diameter; 30 mm					
Cooling method	Forced cool air circulation					
Compressor	Hermetic type, Output; 300 W					
Condenser	Fin and tube type					
Evaporator	Fin and tube type					
Refrigerant	R-134a					
Defrosting	Cycle defrost, Forced type, Fully automatic					
Temperature controller	Electronic control system					
High temp. alarm	Changeable, Lamp flashing, Buzzer and remote alarm					
Low temp. alarm	Changeable, Lamp flashing, Buzzer					
Door alarm	Door alarm lamp ON, Buzzer after delay of 2 minutes					
Memory back-up	Nonvolatile static memory					
Fluorescent lamp	White light 40 W x 1 (Glow starter; FG-4P)					
Temperature recorder	7-day type					
Accessories	1 set of key, 2 sets of bolt					
Battery	6 V, 1100 mAh (Ni-MH)					
Weight	245 kg			290 kg		

Note: Design or specifications will be subject to change without notice.

PERFORMANCE

Chamber temperature	+4°C ± 1.5°C					
Usable ambient temperature	+5°C to +35°C					
Power failure alarm duration	24 hours (with the battery full charged)					
Maximum pressure	1220 kPa					
Noise level	45 dB (A scale)					
Rated voltage	AC 110 V	AC 115 V	AC 220 V	AC 220 V	AC 230 V	AC 240 V
Rated frequency	60 Hz	60 Hz	60 Hz	50 Hz	50 Hz	50 Hz
Rated power consumption	350 W	350 W	360 W	390 W	390 W	415 W

Note: The unit with CE mark complies with EC directives 89/336/EEC, 93/68/EEC and 73/23/EEC.

CAUTION

Please fill in this form before servicing.
Hand over this form to the service engineer to keep for his and your safety.

Safety check sheet

- | | | |
|--------------------------------|-----|----|
| 1. Refrigerator contents : | Yes | No |
| Risk of infection: | Yes | No |
| Risk of toxicity: | Yes | No |
| Risk from radioactive sources: | Yes | No |

(List all potentially hazardous materials that have been stored in this unit.)

Notes :

2. Contamination of the unit

- | | | |
|------------------|-----|----|
| Unit interior | Yes | No |
| No contamination | Yes | No |
| Decontaminated | Yes | No |
| Contaminated | Yes | No |
| Others: | Yes | No |

3. Instructions for safe repair/maintenance of the unit

- | | | |
|-------------------------------------|-----|----|
| a) The unit is safe to work on | Yes | No |
| b) There is some danger (see below) | Yes | No |

Procedure to be adhered to in order to reduce safety risk indicated in b) below.

Date :

Signature :

Address, Division :

Telephone :

Product name : Blood Bank Refrigerator	Model : MBR-1404G MBR-1404GR	Serial number :	Date of Installation :
--	------------------------------------	-----------------	------------------------

Please decontaminate the unit yourself before calling the service engineer.

7FB6P101236004
(5 April 2005)

Recycled paper

SANYO

SANYO Electric Biomedical Co., Ltd.

10-15, Hongo 3-Chome
Bunkyo, Tokyo 113-8434 Japan

Printed in Japan