

SAMSUNG

OWNER'S INSTRUCTIONS

SR-L626EV
SR-L628EV
SR-L676EV
SR-L678EV

REFRIGERATOR

Before operating the unit, please read this manual thoroughly,
and retain for future reference.

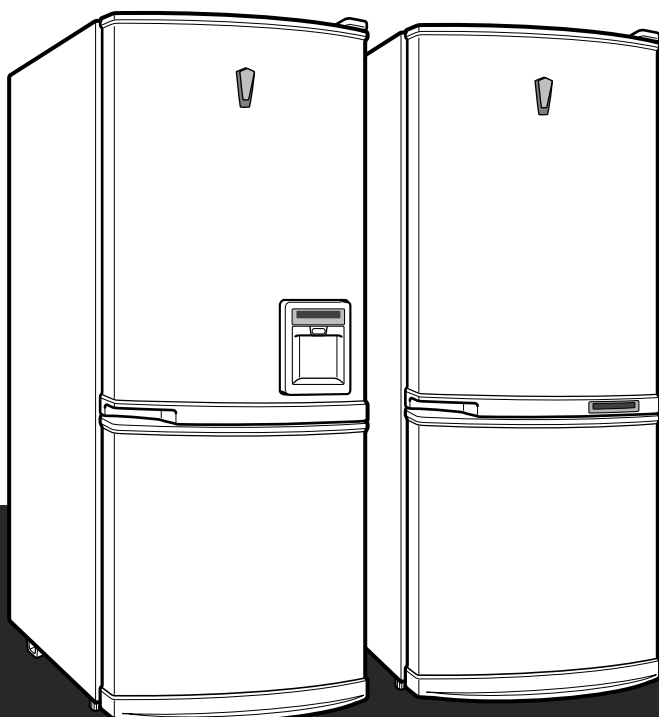

If you took out of the
power supply outlet, you
should plug in again after
five minutes.

FEATURE

The World Best Energy Saving Refrigerator!

- The world highest ranking refrigerator in saving energy consume the minimum of electric power by employing the H. M. Cycle System.

Super quick-cooling function!

- Foods can be stored in the fresh condition by cooling quickly the foods when the function of quick refrigeration or freezing is selected (Pages 10.12).

Being fresh and lively with high humidity in the whole of refrigerator as well as in the vegetable room!

- Freshly storing is available through the separate cooling system by supply of highly-humidified cold of 4~ 5 times as much as the old refrigerator.

Refrigeration room on the upper level, freezing room with the drawer type!

- The vegetable room is designed on the basis of ergonomics adjusting it waist-high because of high frequency in use.
- The drawer-type freezing room prevents the cold from any losing and stores foods cleanly and conveniently.

The X-FLOW cooling system supplies cold even to the refrigerator's corners uniformly!

- Because the rotating wings distribute cold uniformly in the refrigerator, the foods stored even in the corners are evenly refrigerated, and it minimized the leak of cold out of the refrigerator when opening its door.

Three wavelength fluorescent lamp!

- The three-wavelength fluorescent lamp in the refrigerator does not dazzle to the eyes and shows foods in natural color.
- It is convenient to use the refrigerator because of showing its inside brightly and refreshingly.

Green product considering the earth environment!

- This is the product to protect environment by using the up-to-date insulation and latest refrigerant, zero of the ozone layer destructive index.
- Further, the unit is produced with the material which can be easily reutilized by the state of the art assembling technology by reducing the amount of the environmental contamination substance - PVC Styrofoam (EPS).



Meaning of H. M. Cycle (High-efficiency Multi-evaporator Cycle)?

- High-efficiency cooling system with separate installation of evaporator and cooling fan in freezing and refrigerating rooms respectively.
- New cooling system to save energy, to have function of quick cooling and to supply cool air with high humidity.



X-Flow cooling system is a new rotating cooling system that refrigerates the inside of refrigerator quickly and uniformly by rotating wings transmitting cold in all the corners.







CONTENTS

FEATURE.....	1
WARNING FOR SAFETY.....	2
CAUTION FOR SAFETY.....	4
INITIAL OPERATION.....	6
INSTALLATION.....	7
INSTALLATION METHOD.....	8
FRONT CONTROL PART.....	9
TEMPERATURE CONTROL METHOD OF REFRIGERATOR....	11
TEMPERATURE CONTROL METHOD OF FREEZER.....	13
STORING METHOD OF STORAGE FOODS.....	15
WATER DISPENSER.....	17
(RELEVANT MODEL:SRG-L628EV, SRG-L678EV)	
STORAGE METHOD OF FROZEN FOODS.....	19
METHOD OF ICE MAKING.....	20
DISASSEMBLING METHOD OF ACCESSORIES.....	21
CLEANING METHOD OF ACCESSORIES.....	23
CLEANING METHOD OF WATER DISPENSER.....	25
(RELEVANT MODEL:SRG-L628EV, SRG-L678EV)	
CHECKS PRIOR TO SERVICE REQUEST.....	27
CAUTIONS WHEN USING.....	29
REPLACING METHOD OF INDOOR LAMP.....	30
AUTOMATIC FUNCTION.....	31



WARNING FOR SAFETY

This is to prevent users or other persons from being wounded or injured, by using the present product properly. Be sure to observe these contents for safety. (After reading these contents, please keep in such a safe place as to look up)

Contents of Indication

	Represents the contents of prohibition.
	Represents the prohibition of disassembly.
	Represents the prohibition of contact.
	Represents what has to be observed.
	Represents that a power plug has to be separated from the plug socket.
	Represents earth for prevention of electric shock.

Contents of Caution/Warning

 Warning	Represents the contents that death or heavy injury of a person is foreseen.
 Caution	Represents the contents that injury of a person or damage of material is foreseen.

Warning

Do not insert the plug sockets for many products at the same time.

◆ May cause abnormal generation of heater fire.

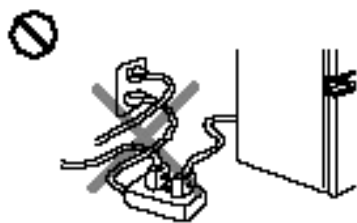

Set the power plug free from the back side of the refrigerator.

◆ Damaged power plug may cause fire due to overheating.

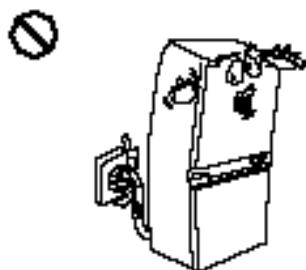

Do not directly spray water inside or outside of the refrigerator

◆ May cause fire or electric shock.



Do not spray inflammable gas near the refrigerator.

◆ May cause explosion or fire.



Do not bend the power cord with excessive force or do not have the power cord pressed by heavy articles.

◆ May cause fire.

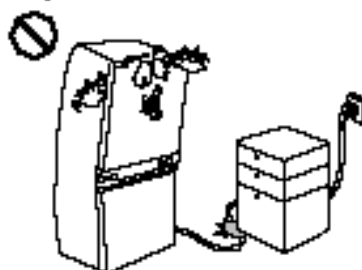

Do not insert the power plug with the wet hand.

◆ May cause electric shock.

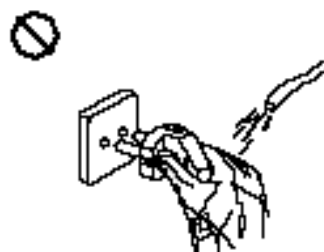

 **Warning**

Do not put a container filled with water on the product.

- If water poured, it causes bad insulation of the electric parts which may lead to fire or electric shock.



Do not install the refrigerator in the wet place or the place which water splashes.

- Deterioration of insulation of electric parts may cause electric shock or fire.



Do not store a volatile and inflammable substance in the refrigerator.

- Storage of benzene, thinner, alcohol, ether, LP gas, etc., may cause explosion.

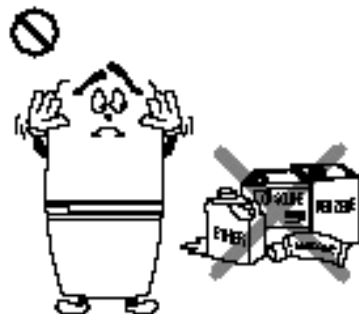

Do not disassemble, repair or alter.

- It may cause fire or abnormal operation which leads to injury.



Pull the power plug out for exchanging the interior lamp of the refrigerator.

- It may cause electric shock.



If you want to throw away the refrigerator, throw it away after tearing off the door or its packing.

- If the door is closed while a child enters and plays there in, it may cause danger.

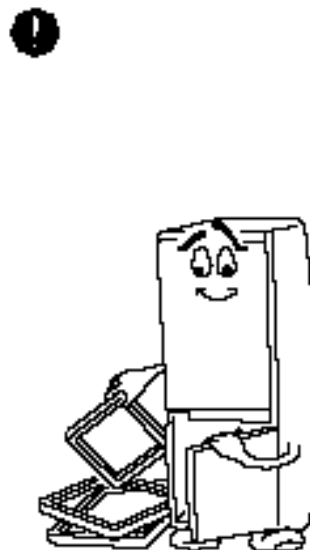

Be sure to earth.

- If earthing is not done, it will cause breakdown and electric shock.

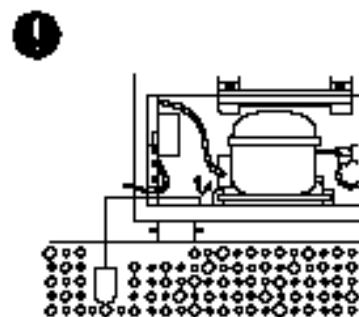

If and when gas leaks, immediately ventilate without touching the refrigerator and the plug.

- Explosion of gas may cause fire and a burn.



CAUTION FOR SAFETY

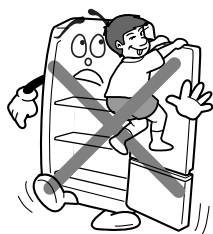
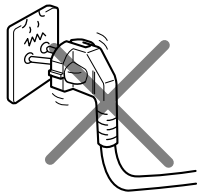
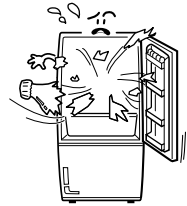



Caution

Please wipe out foreign materials of the metal portion of the power plug clearly.

- Use of it as it is may cause fire.

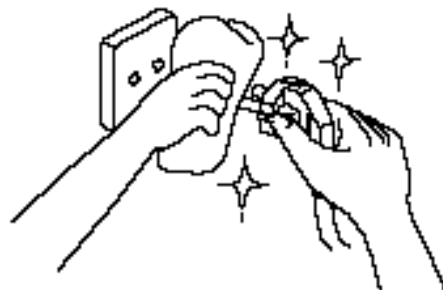

Do not enter the hand into the bottom surface of the product.

- Sharp edge may inflict a wound.



Move it by catching the upper handle of rear side and the lower handle of front side.



If you want to insert the power plug again, please insert it five minutes after pulling out of the plug socket.

- Abnormal operation of freezing device may cause breakdown of it.

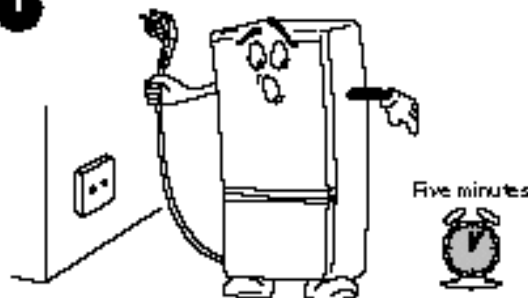

If the refrigerator is not to be used for a long time, pull out the power plug.

- Due to deterioration of insulation, may cause fire.

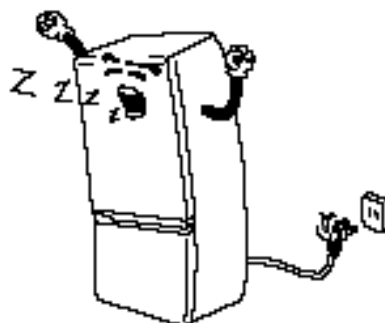

Do not let the control element of the front side be touched or played by children.



INITIAL OPERATION

All of the following should be satisfied when tested in the following order. If not, check electricity supply. When cause of trouble can not be located, contact your dealer.

1

Place all shelves, all kinds of vessels in their proper positions which have been removed for transportation.

4

Set temperature control at "HIGH" position and let refrigerator operate for one hour. Freezer compartment should get slightly chilled and motor should run smoothly with no noise but soft hum.

2

Clean refrigerator and parts to remove dust incurred in shipping and packing.

5

Store food after the temperature in the refrigerator gets sufficiently low. It takes a few hours after starting the refrigerator to reach the proper temperature.

3

Interior lamp should light on during refrigerator door is opened.

Your refrigerator is operated by a compressor which switches "on and off" to maintain the internal temperature. When the compressor is new, it requires running in for a period of up to 5 months. During this period it may operate a little noisily. This is quite normal and does not represent a fault.

INSTALLATION

1 Allow an adequate space and install the refrigerator on firm, flat floor.

- If the unit is not leveled, there may be unusual noises and poor cooling

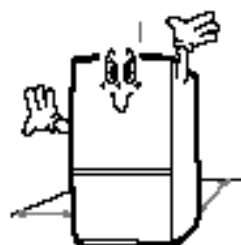

2 Clean up the refrigerator

- Wipe and clean the unit with a squeezed dish cloth inside and outside.



3 Insert the power plug into the exclusive receptacle.

- This appliance must be properly grounded.
- It is recommended that the unit is connected to a power source one hour after installation.

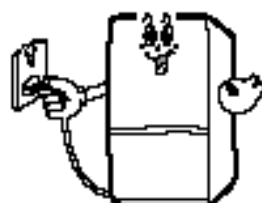

4 Load the refrigerator with foods

- It is recommended that the foods are filled in the unit after its inside gets cold by plugging in 2~ 3 hours before loading the appliance.



Warning

In case of the exclusive electric outlet with a grounding terminal.

- In case of electric outlet with a grounding terminal, it does not require a separate grounding connection.

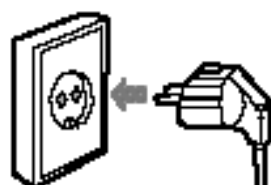

In case of the electric outlet without a grounding terminal.

- Connect the "grounding wire" to the copper plate, and bury it in the wet ground 25cm deeper.

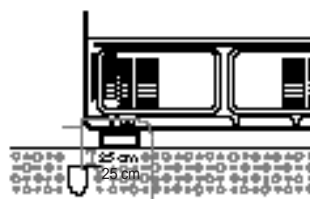

INSTALLATION METHOD

Allowing a 5CM space on the right, left and back sides when installing the unit, makes you have an advantage in saving power consumption.

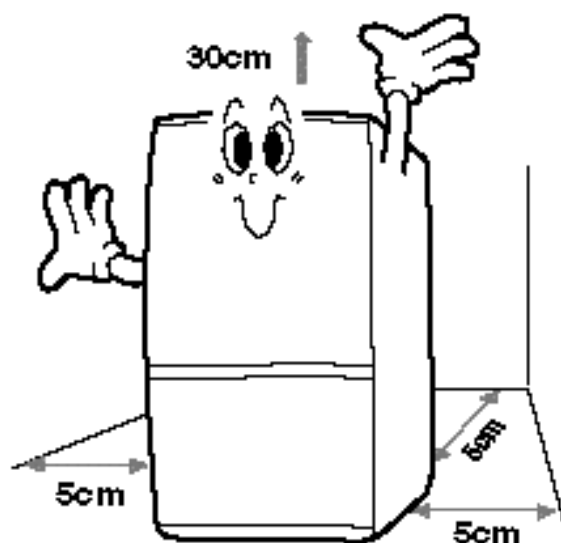

LEVEL THE REFRIGERATOR

When you install the front of the unit on a little higher level, its door can be easily opened and closed.

1

When the door is sagged to the left, downward.

Turn the left adjusting leg to the arrow direction and level the unit.



2

When the door is sagged to the right, downward.

Turn the right adjusting leg to the arrow direction and level the unit.



FRONT CONTROL PART

Relevant Model : SRG-L626EV/ SRG-L676EV

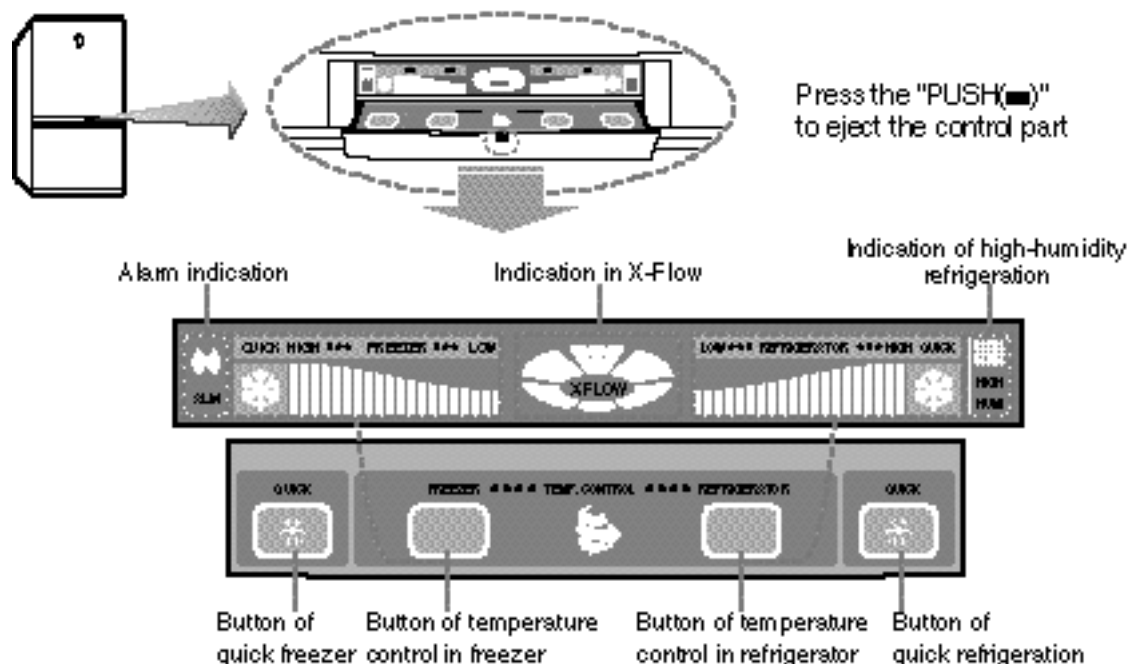

Relevant Model : SRG-L628EV/ SRG-L678EV

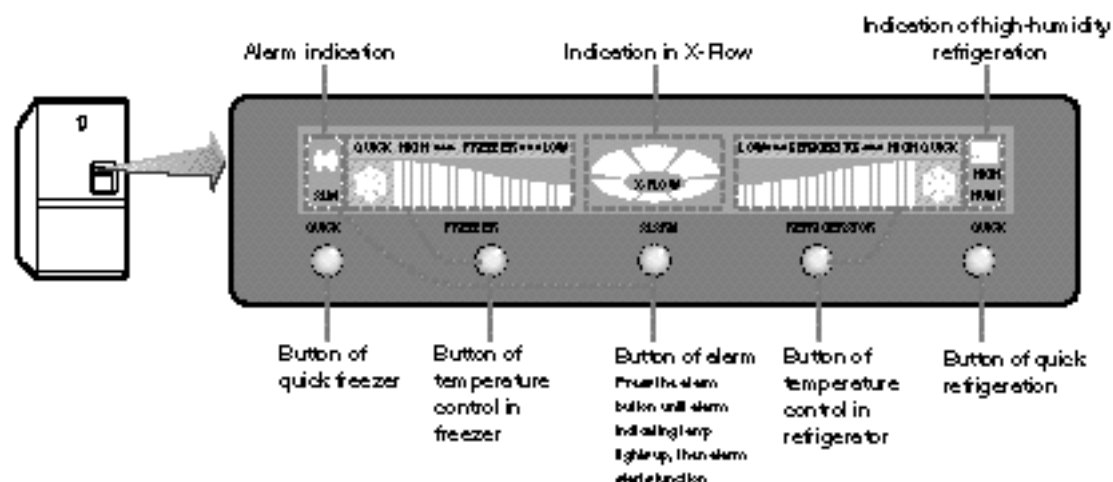



FOR INDICATION PART

High-humidity refrigeration function (HIGH HUMI)

The high-humidity refrigeration indicating lamp lights up all the way through operation of the unit.

- The refrigerator can store foods in the fresh condition by supplying the highly humidified cold with the separate evaporator in the refrigerating and freezing rooms.



Alarming function (when door is open) (ALM)

When the refrigerator's door is open, the unit alarms (ding-dong-ding-dong)

- When the door of refrigerator or freezer is open longer than 2 minutes, the appliance alarms for 10 seconds, and repeat alarming for 10 seconds if the doors is not closed after the lapse of 50 seconds.
- The unit alarms for 10 minutes at intervals of one minute. Nevertheless, if the door is not closed, the alarm stops understanding the unit is in clean-up.



X-Flow indication function (X-FLOW)

When the inside temperature of the refrigerator increases due to heavy load of foodstuff therein, or the door is open, the X-Flow indication lamp lights up automatically.

- When the refrigerator gets cooled down with in a shortest time by the rotating cooling system, and the temperature inside the unit is uniform, the indication light goes out automatically.

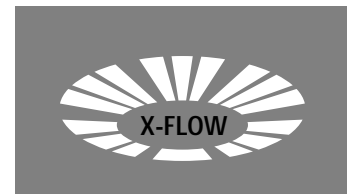

Power-saving function of indoor light

- In case the door is open longer than 10 minutes, the indoor light puts out automatically.

NOTE

TEMPERATURE CONTROL METHOD OF

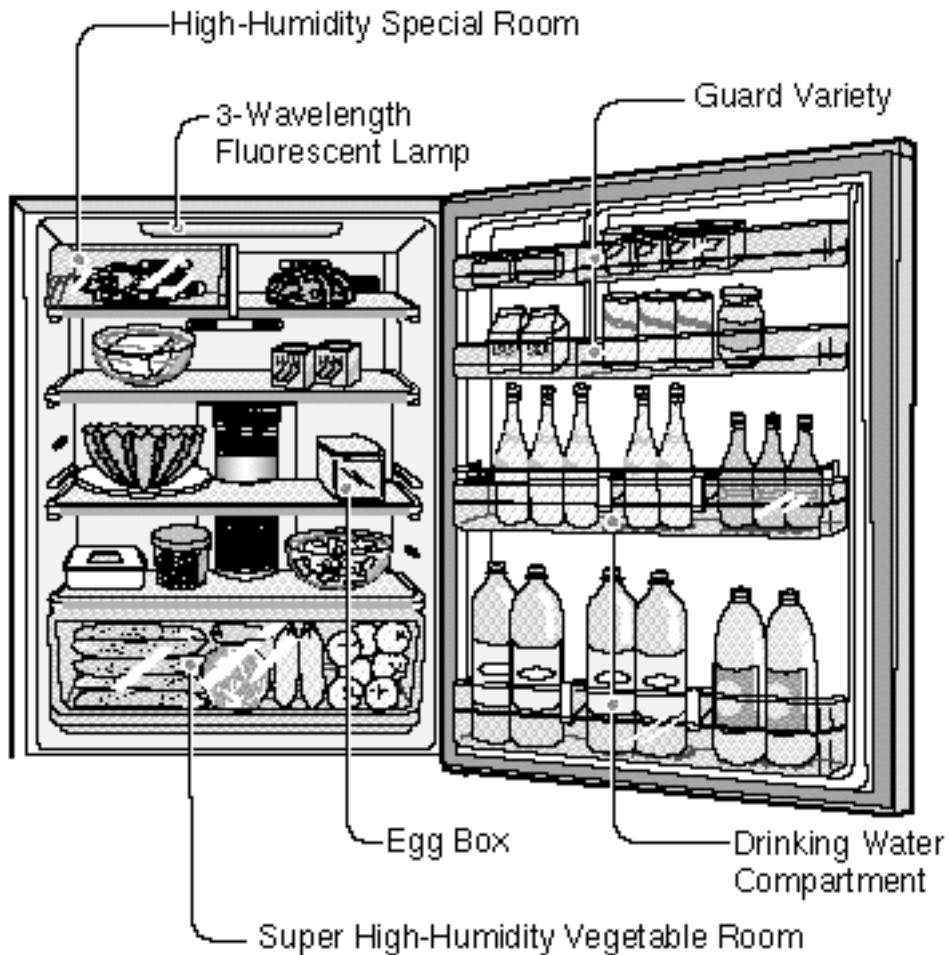

What is the Quick Refrigeration?

This is the function to cool the foodstuff in the refrigerator quickly. It is recommended to select this function when water, beer, beverage, etc. are cooled promptly, and pickled vegetable and other vegetables are stores in the fresh condition swiftly.

Select the Quick Refrigeration if you want to refrigerate the foods quickly upon new installation of a refrigerator.

REFRIGERATOR



QUICK REFRIGERATION/TEMPERATURE CONTROL OF REFRIGERATOR

QUICK : When you want to refrigerate the storage foods quickly.

- Press QUICK button.
- Indication lamp of QUICK lights up, and the temperature returns to the initial set degree when the storage foods are cooled to the extent of the desired temperature, or after the Quick Refrigeration is operated for 2 and half hours.

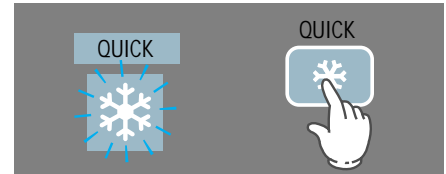

HIGH : When the refrigeration is poor, or the quantity of foods is too much.

- Select "HIGH" by pressing the refrigerator temperature control button.

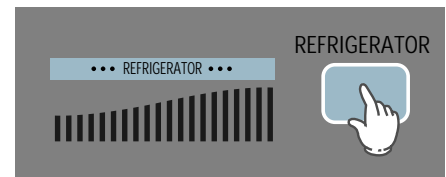

HIGH to LOW : When common use.

- Select the middle position between "HIGH" and "LOW" by pressing the refrigerator temperature control button.
- Select the suitable position as the quantity of storage foods and using frequency.

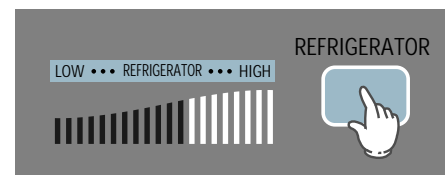

LOW : When the storage foods are frozen, or the quantity of foods is little.

- Select "LOW" by pressing the refrigerator temperature control button.

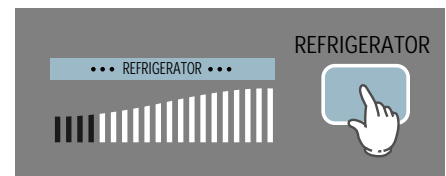

NOTE

The temperature of refrigerator changes in order of "LOW to HIGH" in 5 steps. The temperature indication lamp lights up in order of the 5 steps of "LOW to HIGH" in accordance with the pressing button. The "LOW" will be set up again by pressing once more at the "HIGH".

✳ At the first supply of the electric power, the temperature is automatically set up with "MIDDLE".

TEMPERATURE CONTROL METHOD OF

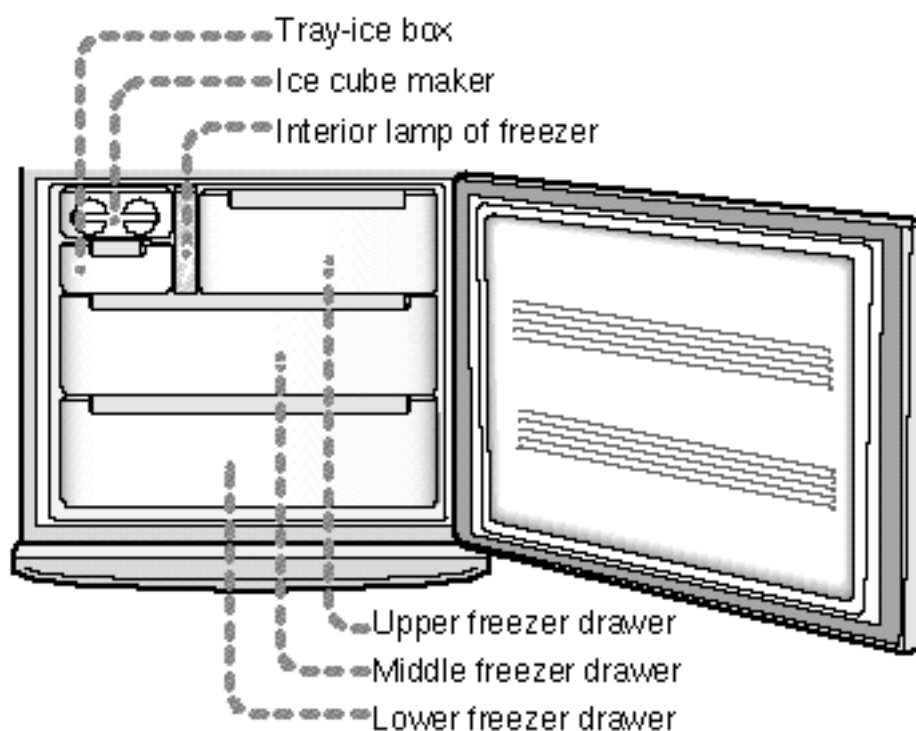

What is Quick Freezer?

This is the function to freeze the storage foods quickly. This selection is recommended when you make ice quickly or freeze meat or fish rapidly and stored it for a long time and freeze lots of foods at a time. Select the QUICK FRE when you want to freeze the foods quickly upon new installation of the refrigerator.

FREEZER



QUICK FREEZER/TEMPERATURE CONTROL OF FREEZER

QUICK : When you want to freeze the storage foods quickly.

- Press QUICK button.
- Indication lamp of QUICK lights up, and the temperature returns to the previous set degree after the QUICK is operated for 2 and half hours.

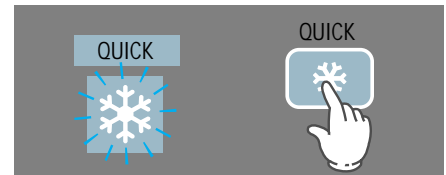

HIGH : When the quantity of the storage foods is too much.

- Select "HIGH" by pressing the freezer temperature control button.

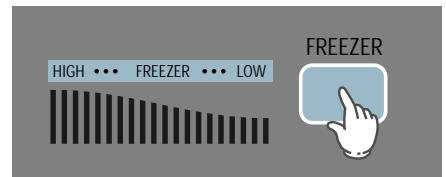

HIGH to LOW : When common use.

- Select the middle position between "HIGH" and "LOW" by pressing the freezer temperature control button.
- Select the suitable position as the quantity of storage foods and using frequency.

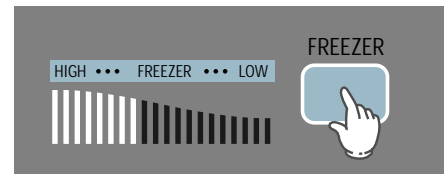

LOW : When the quantity of the storage foods is little.

- Select "LOW" by pressing the freezer temperature control button.

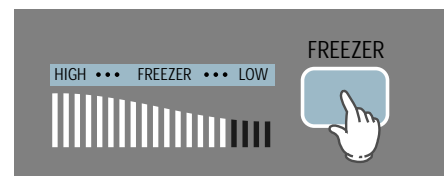

NOTE

The temperature of freezer changes in order of "LOW to HIGH" in 5 steps. The temperature indication lamp lights up in order of the 5 steps of "LOW to HIGH" in accordance with the pressing button. The "LOW" will be set up again by pressing once more at the "HIGH".

※ At the first supply of the electric power the temperature is automatically set up with "MIDDLE".

STORING METHOD OF STORAGE FOODS

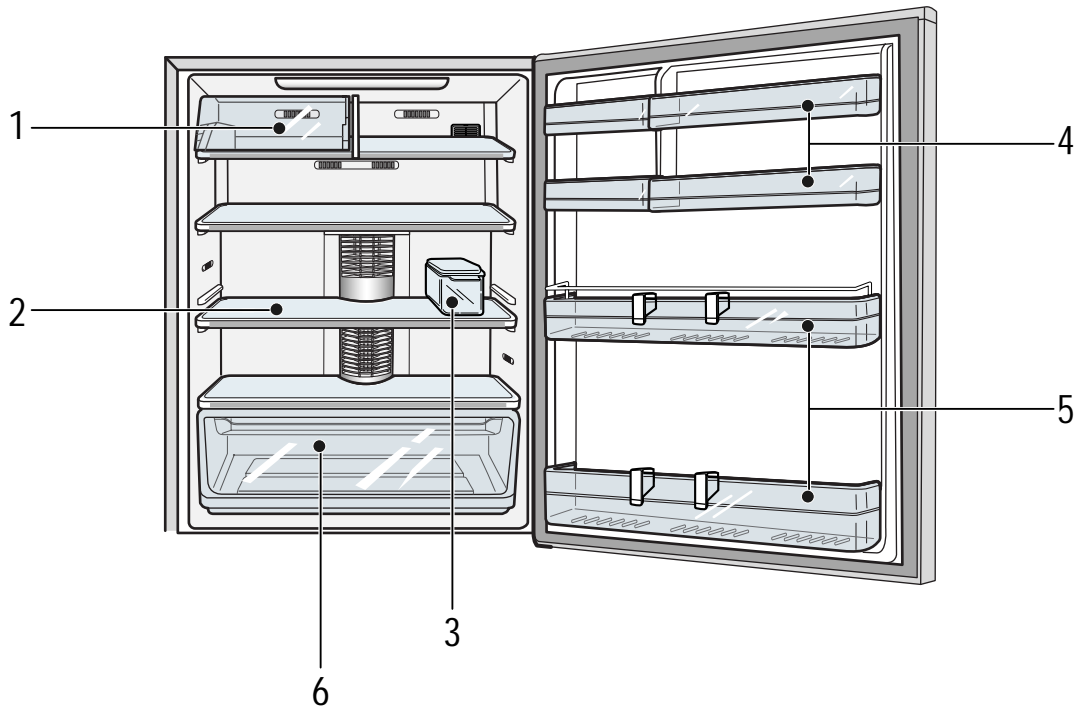

Frequency of opening may makes the refrigerator dewed inside.

1**High-humidity special room**

- ◆ Store the foods which are just ready for cooking such as meat, fish, raw fish, and are slightly frozen.

**2****Transparent safe shell**

- ◆ Store the side dishes contained in storage vessels and other storage foods at suitable intervals.
- ✳ The storage shelf is of safe, unbreakable and transparent material so that you can use it safely.

**3****Egg box**

- ◆ Put eggs into the egg box as shown in figure and store it in the convenient place on the storage shelf.

- ✳ Moisture of egg turns into vapor when it leaves for a long time and it loses some of its freshness, and the adjacent foods are saturated with the egg's smell. Therefore, it is recommended that the egg is put in an egg box and stored in the refrigerator.

**4****Guard variety**

- ◆ Store the small-packed storage foods like butter, milk, yogurt etc. and beverages.

**5****Guard bottle**

- ◆ Store beer, 1L milk, juice in the upper part, and 1.5L vessel or water bottle in the lower part.

Upper part



Lower part

**6****Super high-humidity vegetable room**

- ◆ Vegetable and fruit can be stored



WATER DISPENSER (RELEVANT MODEL:SRG-L626EV/SRG-678EV)

You can drink water easily without opening the refrigerator door especially through water dispenser. In addition, you can save electric charges by reducing the opening frequency by more than 30%.

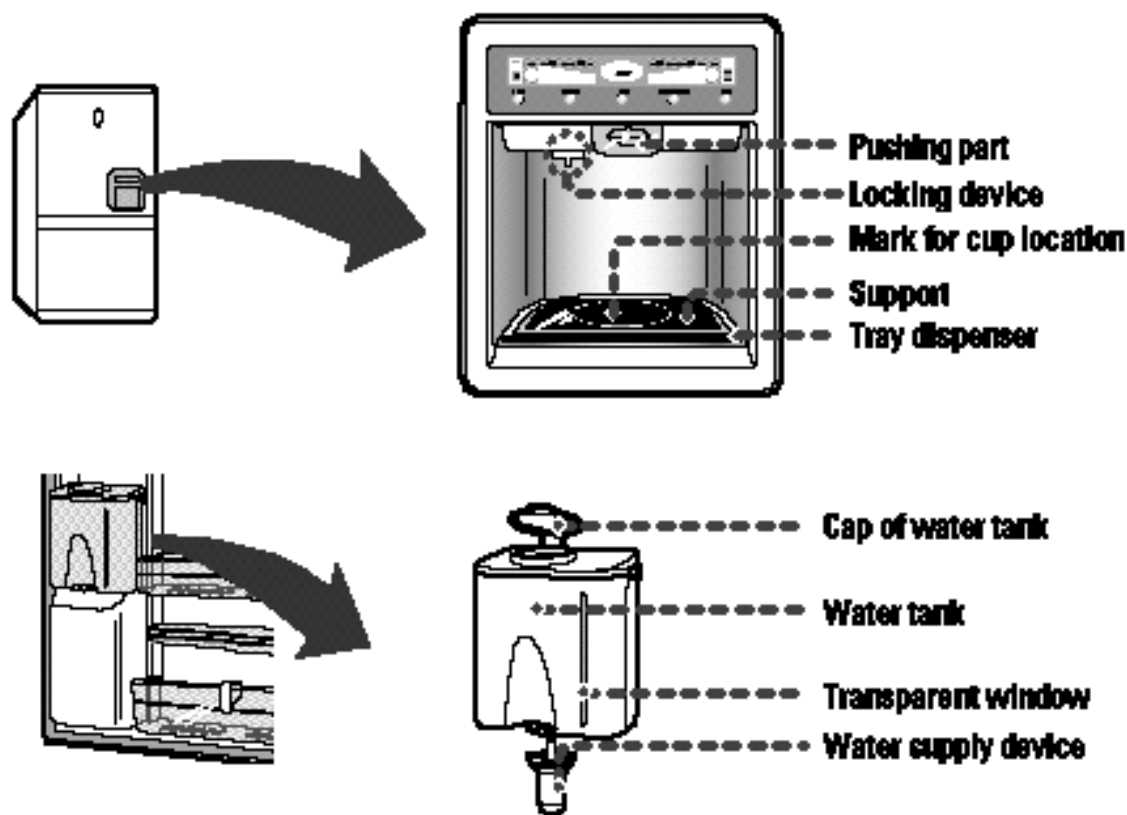

WHEN THE WATER DISPENSER IS NOT USED, THE FOLLOWING WAYS ARE RECOMMENDED

1

Fit the water supply device tightly into the fixing hole.

- The door will not be closed automatically when the water supply device is pulled out for a long time because of cold leaking.

2

Put and use a separate spare beverage bottle in the location of the exclusive water tank.

- Two numbers of 1.5L bottle can be used.

3

Set the locking device to the "LOCK".

- When pressing the "PUSH" button with the water supply device only fixed at the fixing hole, and the locking device is set on "OPEN", the water supply device can be removed from the fixing hole and cold leaks.

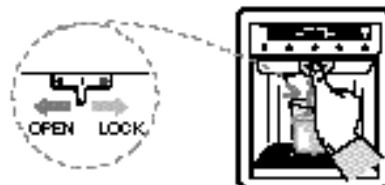



HOW TO DRINK FROM THE EXCLUSIVE WATER TANK

1 Open the water tank by removing the cap and fill it up with the drinking water.

- Fill the tank up to the full level (about 4.2L) which is shown through the transparent window.



2 Close the water tank with the round cap completely until a click sounds.



3 Check if the locking device is set to "OPEN"

Water runs out only by setting to "OPEN"



4 Put a cup on the cup support, then press the "PUSH" button.



HOW TO DRINK BY USING THE REGULAR SPRING WATER BOTTLE

1 Press the fixing lever and raise upward the exclusive water tank, then remove it.

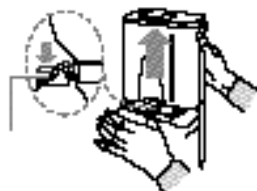

2 Turn loosely the water supply device of the exclusive water tank, then set the inner groove of the water supply device to the regular spring water bottle and fit it by turning.



3 Bottom up of the water supply device, then fit it completely to the fixing hole.



NOTE

- When exposing to child, set the locking device to the "LOCK".
- Sound of gurgles is heard (when air enters the water tank) when water comes out of the regular spring water or beverage bottles.
- The regular spring water bottle or beverage bottle does not fit the water supply device in some cases according to the individual company's characteristic.
- In case that water does not come out satisfactorily even though the "PUSH" button is pressed, press it once more.



NOTE

- Do not use the carbonated drinks such as Cola, Cider (soda pop) (When pressing the "PUSH" button, the beverage may spring out due to the pressure of carbonic gas which is accumulated in the upper part of beverage bottle)
- Use the spring water (live water) or boiled cool water that does not contain any dregs.

STORAGE METHOD OF FROZEN FOODS

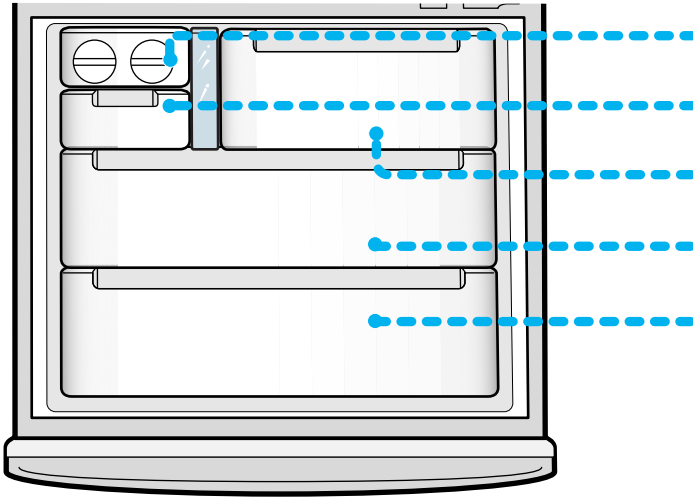

Upper freezer drawer

- Store the packed frozen foods like ice cream, bacon, etc.

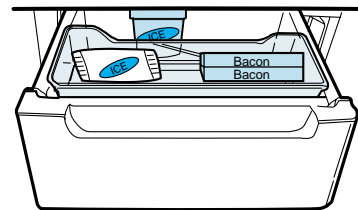

Middle / Lower freezer drawer

- Store fresh and meat, fish or dried foods as laver, anchovy etc., which are divided suitably.

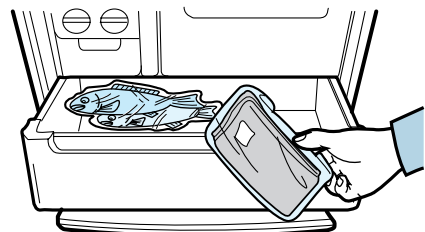

METHOD OF ICE MAKING



HOW TO MAKE ICE

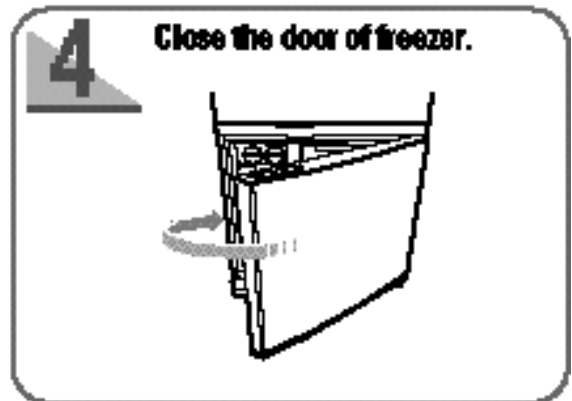
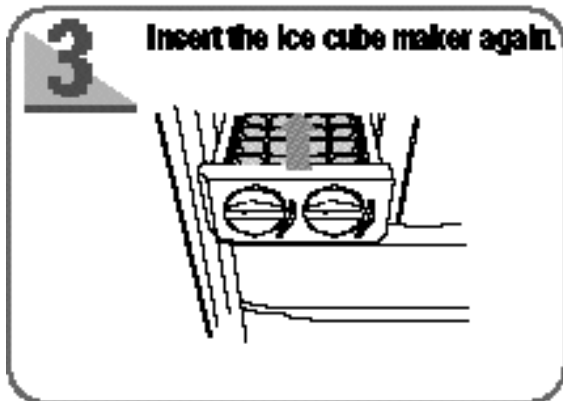
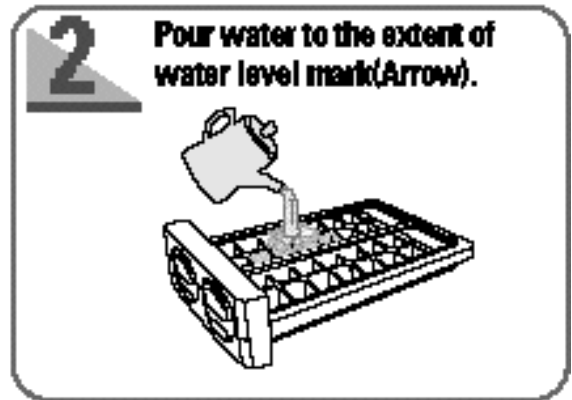
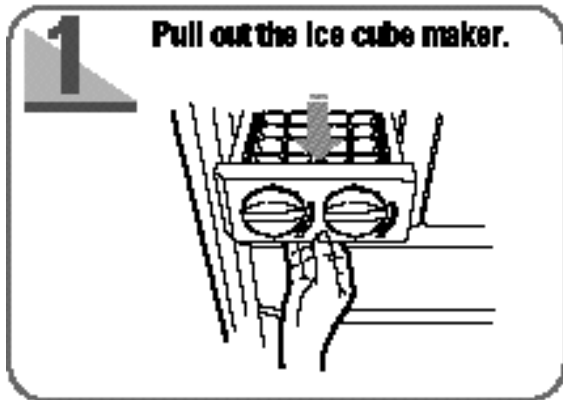

Ice storing method :

- When ice has all frozen (it normally takes about 2 hours.), grab the ice cube maker by its knob, then turn it clockwise until the ice cubes drop all into the tray ice.
- ✧ It is noted that turning the knob in the immature condition makes some ice cubes with water drop into the tray ice box.
- ✧ In case tea water or beverage is frozen, the ice cubes may not drop.

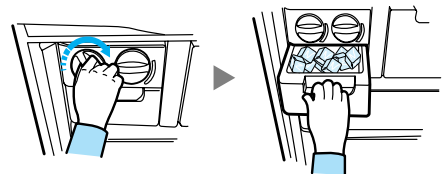

When you want to make ice quickly,

When you wish to freeze water quickly and want to make much quantity of ice, press "QUICK" to select the quick freezing function.

DISASSEMBLING METHOD OF ACCESSORIES

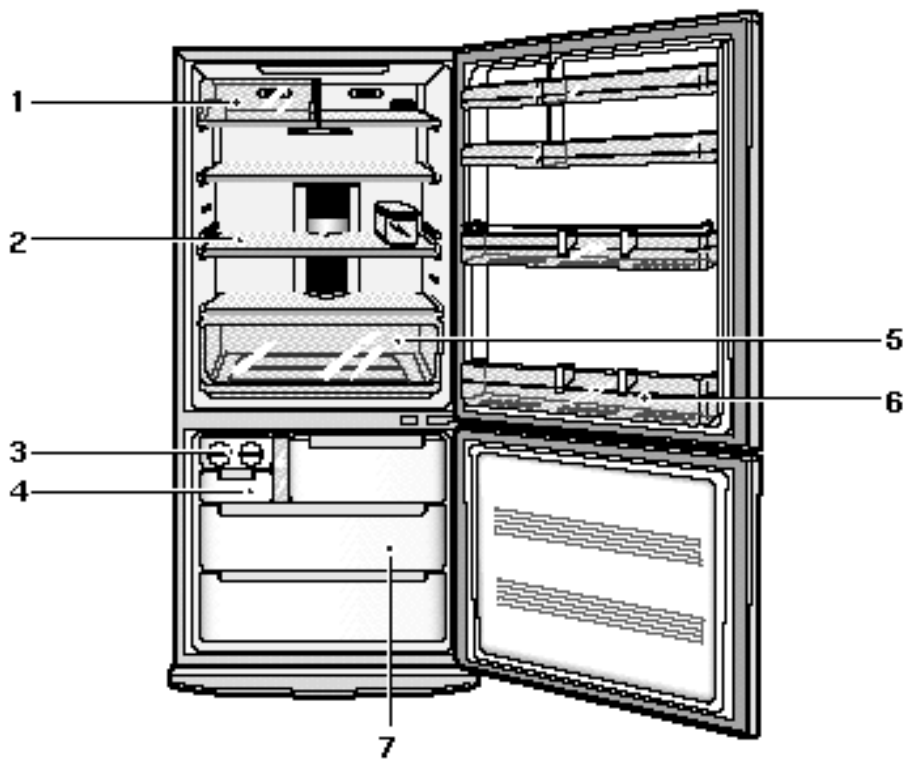

1

High-humidity special room

- Push the cover toward direction and remove it raising the part upward.
- Grab the lower part of high-humidity special room and pull it forward, then remove it raising it upward at the hanging point.

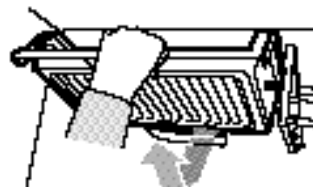
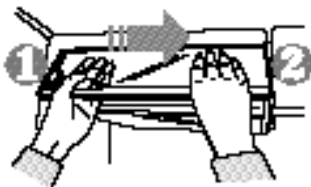

2**Transparent safe shelf**

- Grab the transparent safe shelf by both hands as figure, then remove it pulling out it forward.
- ◆ Remove the transparent safe shelf or adjust the height for use according to the size of the food storage vessel.

**3****Ice cube maker**

- Place a hand to the lower groove, then pull out it forward.

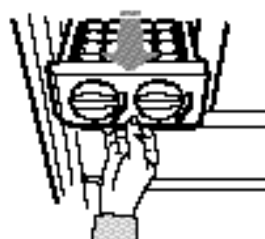
**4****Tray ice box**

- ◆ Grab the handle, and pull it out at the hanging point, then remove it raising it upward.

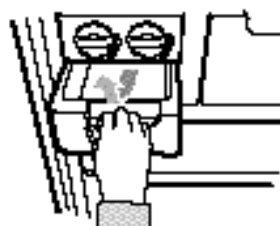
**5****Super high-humidity vegetable room**

- Pull out the super high-humidity vegetable room forward to the middle, then remove it forward raising it upward.

**6****Guard bottle**

- Grab the guard bottle by both hands, then remove it raising it upward.

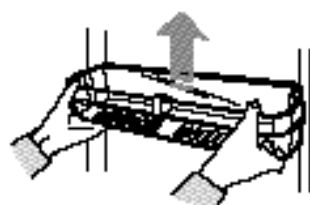
**7****Freezer drawer**

- Grab the freezer drawer by both hands as figure, and pull it out forward, then remove it raising it upward at the hanging point.



CLEANING METHOD OF ACCESSORIES

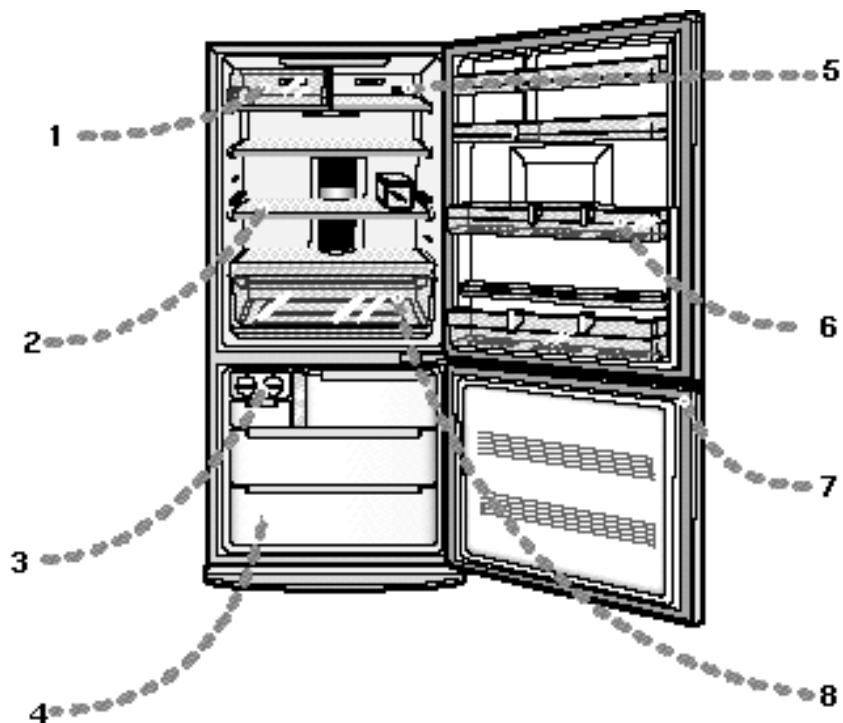

1

High-humidity special room

- Remove the high-humidity special room then clean it up using water and detergent



2

Transparent safe shelf

- Remove the transparent safe shelf, then clean it up using water and detergent.
- ✘ When replacing it, note not to confuse with the upper, middle and ware vegetable.

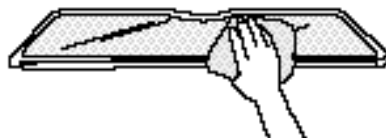

3**Ice cube maker**

- Clean up the ice cube maker with water after pulling it out.

**4****Freezer drawer**

- Wipe the freezer drawer with a wet cloth after pulling it out.

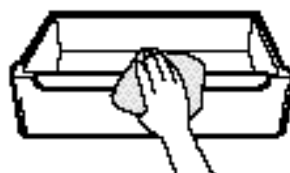
**5****Bio Deodorizer**

- If the refrigerating room smells bad, please separate the bio deodorizer, deep the catalyst in pure water and dry it to sunlight before use.

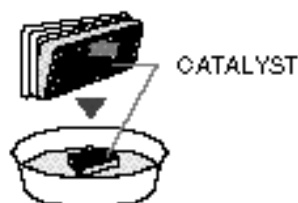

CATALYST

6**Guard bottle**

- Wash to guard bottle with water after pulling it out.

**7****Rubber packing**

- Clean up the rubber packing with a dish cloth which is wet with detergent, and between grooves with a wooden chopstick wrapped up by a cut of cloth.

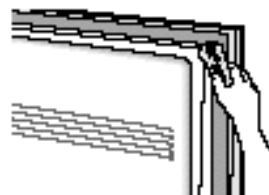
**8****Super high-humidity ware vegetable**

- Wipe out the vegetable drawer using a wet cloth after pulling it out.

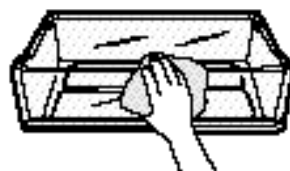
**Warning**

- Disconnect the power plug and open the door for dry when cleaning or out of operating for a long time.
- Do not spray water for clean-up, and do not use benzene or thinner, either.

CLEANING METHOD OF WATER DISPENSER



CLEANING METHOD

Cup support/Tray dispenser

- 1** Press slightly "PUSH" behind the cup support, then remove the cup support



- 2** Grab the handle of tray dispenser, then remove the tray.



- 3** Empty the water in the tray dispenser, then clean it up using warm water and detergent.



Connection path

Wipe out the connection path and surrounding with a clean and wet dish cloth



Caution

Empty and clean up the water tray dispenser frequently.
Overflow of the water tray dispenser may run out

RELEVANT MODEL(SRG-L628EV/SRG-678EV)



CLEANING METHOD FOR EXCLUSIVE WATER TANK AND WATER SUPPLY DEVICE

- 1** Pull upward and disassemble the hookers on both sides of the large-sized cap.

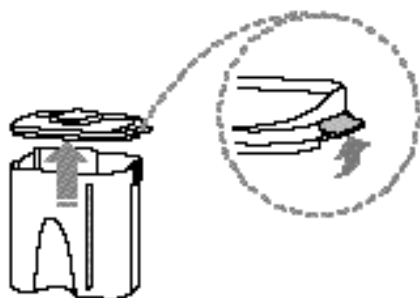

- 2** Turn loosely to the arrow direction and remove the water supply device.

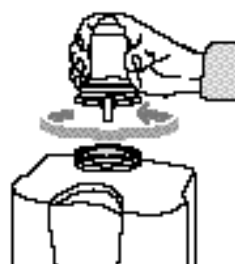

- 3** Wipe the large-sized cap and the exclusive water tank with warm water and detergent.

- Grab the grip, and pull it upward, and remove it, then brush it with a soft brush, when clearing the waste filtering bottle which is attached to the large-sized cap.

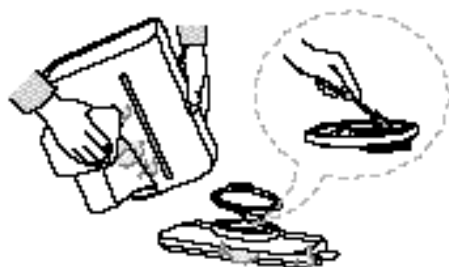

- 4** After the water supply device is cleaned up with a soft brush, press the operation lever of the water supply device, then wash it in the running water.



Caution

- Clean up the water tank frequently when the tea water or beverage is stored. Store the tea water after wastes are filtered. It is hygienic that the beverage (Juice, Soft drink) which contains lots of sugar, is not stored, if possible.



Caution



- Deposit can be cleaned up by wiping with a piece of cloth dampened into vinegar or with salt water.





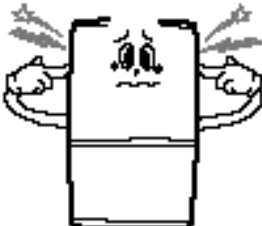
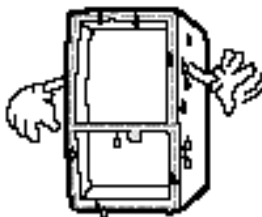

Caution

- Observe the rubber packing of the water supply device not to be slipped off, or not to be damaged by a sharp-edged object. These make leakage of water.

CHECKS PRIOR TO SERVICE REQUEST

SYMPTOMS	CHECKS
<p>The unit is not operating at all, or refrigerating weakly.</p> 	<ul style="list-style-type: none"> ◆ Check if power plug is connected well. ◆ Is the temperature control in front operating part "LOW"? ◆ Does sun shine on the unit, or are there heat sources near by? ◆ Is there the back of the unit too near to the wall?
<p>The foods in the refrigerator are frozen</p> 	<ul style="list-style-type: none"> ◆ Is the temperature control in front operating part "HIGH"? ◆ Is the surrounding temperature too low? ◆ Did you put the watery foods into the cold inside?
<p>There are unusual noises</p> 	<ul style="list-style-type: none"> ◆ Check if the unit is installed on a firm or weak floor. ◆ Is there the back of the unit too near to the wall? ◆ Is any foreign material dropped behind or under the unit? ◆ Isn't the noise from the compressor in the unit? ◆ Sound of "ticking" may be heard from the unit's inside, but it is not out of order. This sound comes when various accessories are contracted or expanded by cooling function.
<p>The front corners and sides of the unit are getting hot and dewdrops form thereon.</p> 	<ul style="list-style-type: none"> ◆ Heat-proof pipes are installed in the front corners of the unit to prevent forming dew. When the surrounding temperature rises, there might be not feeling in some cases. However, this is not abnormal. ◆ In high humid weather, dewdrops might form on the outer surface of the unit with the result that the moisture in the air contacts with the cool surface of the unit.

SYMPTOMS	CHECKS
<p>There are babbling of water in the unit</p> 	<ul style="list-style-type: none"> • This is a babbling of refrigerant which refrigerates the inside of the unit.
<p>There is odoring inside of the unit</p> 	<ul style="list-style-type: none"> • You did not seal the foods which had an odor. • When it smells bad, please clean the bio deodorizer. • Store the odoring foods after they are covered, and clean up the cold inlet.
<p>There is a layer of frost in the unit's walls.</p> 	<ul style="list-style-type: none"> • Isn't the air outlet of the unit plugged? • Keep the foods spaced to be ventilated well. • Isn't the door closed fully?
<p>Dew forms on the inside wall of the unit and around ware vegetable.</p> 	<ul style="list-style-type: none"> • When the watery foods are stored without cover in the high humid surrounding, or with the door opened for a long time. • Store the foods with cover or sealed.

CAUTIONS WHEN USING

Store the watery foods (specially the bean curd) at the front of the refrigerator's shelf.



Store hot foods in the unit after cooling them down

- Storing cold foods saves electric charges, and makes a good refrigeration.



REPLACING METHOD OF INDOOR LAMP



Always take out the power plug when replacing the refrigerator lamp. There is the danger of electric shock.



INDOOR LAMP IN THE REFRIGERATOR

1

Pull down the hanging sill part behind the indoor lamp's cover, then remove the cover.

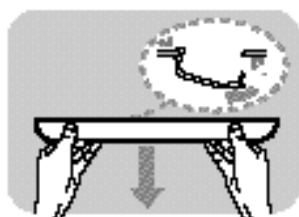

2

Remove the indoor lamp pulling it downward, then replace it with a new one.

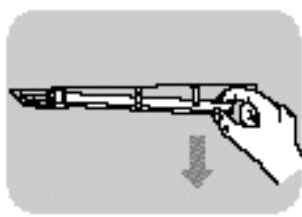

3

Insert the front of the lamp cover, then fit the hanging sill part behind the lamp cover.

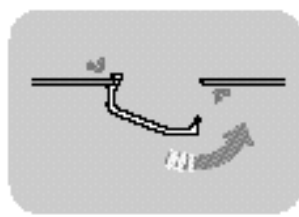

INDOOR LAMP IN THE FREEZER

1

Raise the hanging sill part down the indoor lamp's cover upward by pressing it.

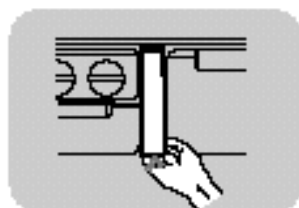

2

Replace the indoor lamp with a new one after removing it by turning it toward the direction of error.

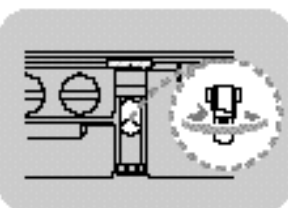

3

Insert the lower hanging sill part after fit the upper part of the indoor lamp's cover.

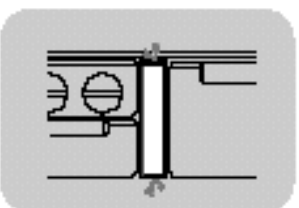

AUTOMATIC FUNCTION

1

Automatic bio deodorization

- ◆ The bio deodorizer is installed to the cold inlet which inhales the air in the refrigerator so that air circulates automatically without any assist and absorbs and resolves food smell completely. Accordingly, the air in the refrigerator is always fresh.
- ◆ The bio deodorizer's life span is semi-permanent. The function of the bio deodorizer is not harmful to the storage foods or person at all, but is used only to remove the smell from the storage foods in the refrigerator.



2

Automatic humidity control

- ◆ This function controls a automatically humidity suitably for the quantity of the vegetable and fruit stored in the super high-humidity vegetable room so that the vegetable and fruit are stored freshly as it is for a long time.



3

Automatic closing door

- ◆ The unit's door is closed automatically thus any loss of cold is prevented and power consumption is reduced, especially when the doors of refrigerator and freezer are open secretly (with 15°C).
- ✳ In addition, the unit has another function that it sounds a melody to inform you that the door is open over 15 degree with the lighted alarm lamp.



4

Automatic compensation function of open air temperature

- ◆ As the temperature in the refrigerator or freezer maintains uniformly regardless of outer temperature or season, it is not required to change the set temperature.

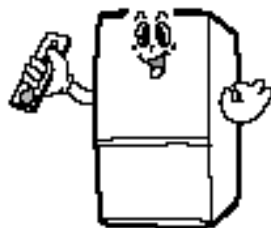

MEMO



ELECTRONICS