

SMARTSCOPE

USER'S MANUAL Optomed Smartscope M5 Medical Camera

Optomed SMARTSCOPE is manufactured by Optomed Oy.

Place of Business:
Optomed Oy
Hallituskatu 13-17 D
FI-90100 Oulu
Finland

Manual version: Rev 3.0, SW 3.2
Date: 2015 03 27



This manual describes guidelines for the following modules:

Smartscope M5 camera with optics lenses and accessories:

Model:	Description:	Accessories
Smartscope EY3	module for retinal imaging	eye cup, quick user guide
Smartscope ES1/ES2	module for anterior ophthalmic imaging	
Smartscope SK1	module for dermatoscopic imaging	
Smartscope OT1	module for otoscopic imaging	ear specula pack air pump
Smartscope Cradle V1	for data transmission and battery charging	USB cord Power unit

If not all optics modules were purchased then the sales case does not include them or the accessories related to that optics module.

In addition the sales case includes:

- Batteries (2 pcs)
- Cleaning cloth
- User manual
- USB memory stick (Includes training material, WIFI SW & guide and Workstation SW & guide).

The following accessories can be purchased separately:

- **Optomed Slit Lamp Adapter** that enables the camera to be used as stationary imaging tool.

Quick start guide

WHAT TO DO BEFORE THE FIRST USE:

1. Remove Optomed Smartscope M5 from the sales package and check that all parts are undamaged.
2. Install Battery as instructed in the **Appendix B, last page of this manual**.
3. Place Cradle on a desk next to the PC (Personal Computer).
4. Connect the other end of the USB-cable to the PC.
5. Connect power unit to the wall plug (mains)
6. Place Optomed Smartscope M5 to the cradle. Battery starts to charge. Charge battery for four hours before the first use. When device is not used, it may be stored in the Cradle.



Guideline for placing the camera to the cradle:

Camera will fit to the cradle when it's hold straight while placing it. Excessive force shall be avoided in order to prevent the camera and cradle connectors form breaking.



Guideline for battery and device storage:

If battery is stored out of the camera for longer period of time, ensure that battery is fully charged before storage. During storage battery shall be re-charged occasionally (e.g. every 3-9 months).

If battery is stored in the camera, camera shall be placed in the cradle with cradle power cable connected.

Normal battery life time is expected to be 1-2 years.

Table of contents

Quick start guide	3
Table of contents.....	4
1. Indications for use	5
2. Contraindications for use of the eye optics module EY3 and ES2	6
3. Warnings and cautions.....	7
4. Important symbols	8
5. Parts of the device.....	9
6. Usage environment requirements	12
7. Operating instructions.....	13
7.1. Preparations	13
7.2. Connection to a PC	13
7.3. Basic use – starting up, shutting down and taking an image	13
7.4. Attaching and detaching optics module.....	14
7.5. Device Menu.....	15
7.6. Adjusting focus and automatic focus	19
7.7. Reset button	19
8. Retinal imaging using optics module EY3.....	20
9. Eye imaging using anterior ophthalmic module Smartscope ES1/ES2	25
10. Ear imaging using otoscopic lens Smartscope OT1	29
11. Skin Imaging using dermatoscopic optics module SK1	33
12. General imaging without optics module.....	37
13. Error messages	39
14. Cleaning instructions	40
15. Device maintenance	41
16. Technical description	42
17. Warranty	48

Appendixes:

Appendix A: Electromagnetic compatibility information

Appendix B: Battery replacement

Appendix C: WIFI installation guide

1. Indications for use

Smartscope M5 is a medical digital camera that is used with dedicated optics lens intended to take images of the eye fundus, surface of the eye, ear canal and tympanic membrane, and skin.

Supported optics lenses and their intended uses are:

Model:	Description:
Smartscope EY3	Optomed Smartscope M5 digital camera with EY3 optics module is intended to capture digital images and video of the fundus of the human eye.
Smartscope ES2&ES1	Optomed Smartscope M5 digital camera with ES2&ES1 optics module is intended to capture images and video of the surface of the human eye and surrounding areas.
Smartscope SK1	Optomed Smartscope M5 digital camera with SK1 optics module is intended to capture images and video of the surface of the human skin.
Smartscope OT1	Optomed Smartscope M5 digital camera with OT1 optics module is intended to capture images and video of the human ear.

2. Contraindications for use of the eye optics module EY3 and ES2

Because prolonged intense light exposure can damage the retina, the use of the device for ocular examination should not be unnecessarily prolonged, and the brightness setting should not exceed what is needed to provide clear visualization of the target structures.

The retinal exposure dose for a photochemical hazard is a product of the radiance and the exposure time. If the value of radiance were reduced in half, twice the time would be needed to reach the maximum exposure limit.

While no acute optical radiation hazards have been identified for direct or indirect ophthalmoscopes, it is recommended that the intensity of light directed into the patient's eye be limited to the minimum level which is necessary for diagnosis. Infants, aphakes and persons with diseased eyes will be at greater risk. The risk may also be increased if the person being examined has had any exposure with the same instrument or any other ophthalmic instrument using a visible light source during the previous 24 hours. This will apply particularly if the eye has been exposed to retinal photography.

Smartscope EY3 and ES2 are classified as Class 2 based on standard ISO15004-2:2007. The daily usage time and maximum allowed number of pulses is calculated based on optical classification results according to standard ISO15004-2:2007.



CAUTION:

“The light emitted from this instrument is potentially hazardous. The longer the duration of exposure and the greater the number of pulses, the greater the risk of ocular damage. Exposure to light from this instrument when operated at maximum output will exceed the safety guideline after:

Maximum number of pulses (still images) allowed daily:

- EY3: 5000 pulses (still images) / eye
- ES2: 250 pulses (still images) / eye

Or alternatively

Total daily usage time for continuous light (= video usage time + aiming light duration) shall be limited to:

- EY3: 1 h 30 min video usage / eye
- ES2: 8 min video usage / eye

3. Warnings and cautions



Place PC and cradle outside the patient environment (at least 1.5 meters distance from the patient).



Use only accessories and battery provided by Optomed with this product.



Connection between camera and workstation is USB and/or WIFI. Any authorization procedures should be carried out in workstation.



Images and videos can be copied from camera to workstation via USB and/or WIFI and then viewed in workstation.







USB write protection is on by default. When protection is on this feature will prevent writing to camera memory card from PC when connected to the cradle. In case device has WIFI functionality, USB write protection must be turned off.



No modification of this equipment is allowed.

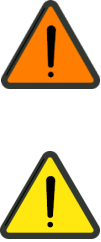

4. Important symbols

Symbol	Description
	<p>The CE mark on this product indicates it has been tested and conforms to the provisions noted within the 93/42/EEC Medical Device Directive. CE mark with notified body identification number indicates a class IIa product.</p>
	<p>Read accompanying user documentation indicates that important operating instructions are included in this User's and Maintenance Manual. Failure to follow these instructions could place the patient or operator at risk.</p>
	<p>Type BF applied parts.</p> <p>Applied part is a part of Smartscope that in normal use necessarily comes into physical contact with the patient.</p>
 <p>9V, 1.1 A</p>	<p>Charger polarity symbol, voltage and power</p>
	<p>Sticker at the front of the device indicating Optomed's address, integrated general imaging optics focal length and F-number.</p>
	<p>WARNING Indicates a hazardous situation which could result in patient injury, harm or death if the appropriate safety precautions are not followed.</p> <p>CAUTION Indicates a situation which could result in device harm, damage or mal-function if the appropriate cautions / precautions are not followed.</p>

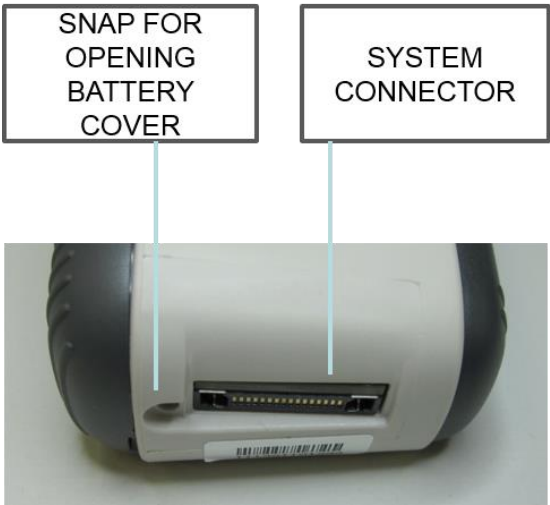
5. Parts of the device





Soft key indicators:

Position	Indicator	Purpose
Left soft key		To power on the device To power off the device, with long press
Right soft key		Open menu with long press

LED indicators:

The recharging and connection to PC is indicated with green (charging) and blue (connection) LED-lights:

Position	Indicator	Purpose
Left LED-indicator Green		Active when device is powered on, blinking when charging in cradle.
Right LED-indicator Blue		Active when devices is placed to the cradle and connected to a PC.

Graphical indicators:

These indicators are displayed on the top row of the display during imaging:

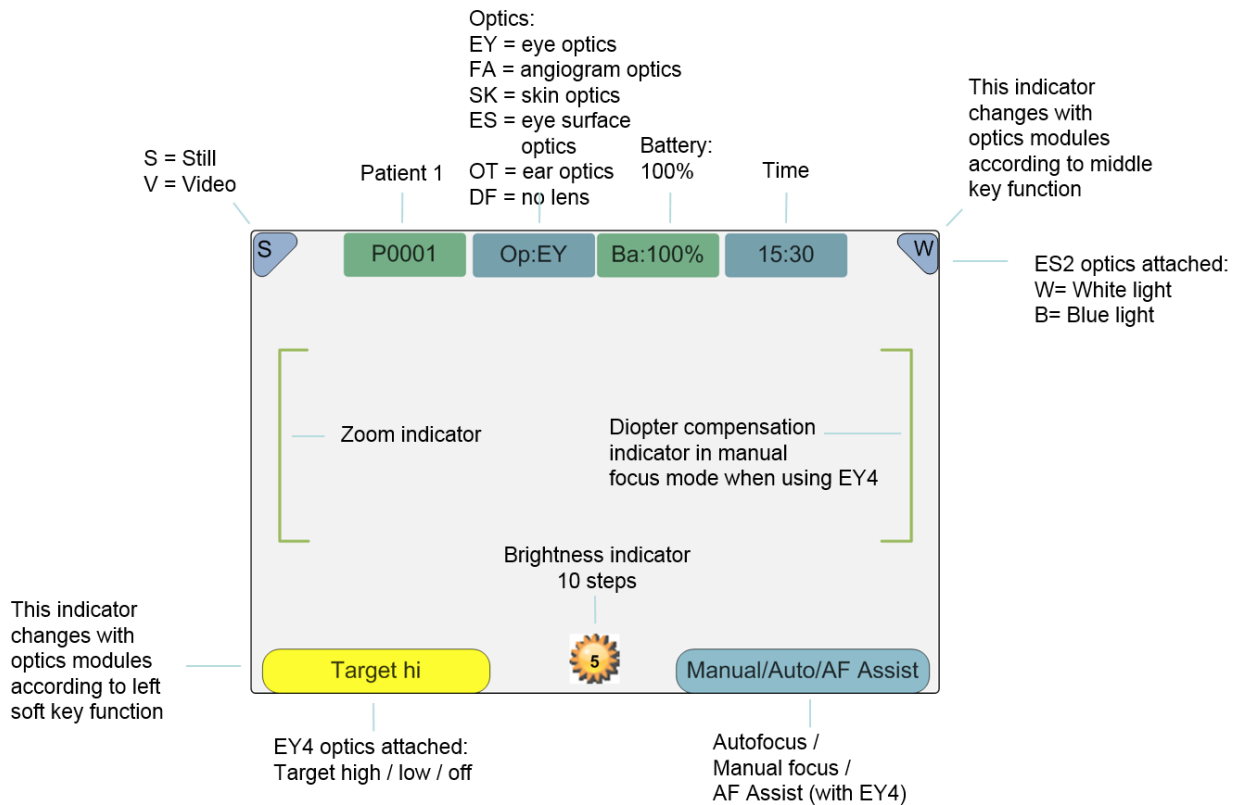

6. Usage environment requirements



WARNING:
Smartscope is not suitable for use in the presence of flammable anesthetics.



WARNING:
Place PC and cradle outside the patient environment (at least 1.5 meters distance from the patient).



CAUTION
Smartscope is intended to be used inside in a normal room temperature and normal humidity. Do not use Smartscope in an environment where there is possibility that water condenses to or inside the Smartscope. Type of the power source is indicated in Chapter 16, Technical description.



CAUTION:
It is only allowed to attach USB cable and Power source provided in the sales package into the cradle. If you need replacement to the USB cable or Power source please contact Manufacturer or your own Retailer.

USB Cable must be connected only to the USB port of a PC computer that complies with the IEC 60950 standard. Avoid using excessive power or twisting the connector when connecting the USB cord to a PC.

To transfer patient image data the device must be used together with a PC (Personal Computer) running either Microsoft Window Vista®, Windows 7® and Windows 8®. The device does not need any drivers to be installed on a PC.

Optomed recommends to use the memory card, which is supplied with the device.

In case device has WIFI functionality, memory card is permanently installed.

Writing to the memory card from PC is not enabled by default.

Device shall be used according to this manual, quick reference guide and / or information found on Optomed website www.optomed.com.

Electromagnetic compatibility information and recommended separation distances between portable and mobile RF communications equipment and the Optomed Smartscope are given in the Appendix A.

7. Operating instructions

This chapter gives instructions for using the device. More specific instructions for using optics lenses are given in the optics lens specific chapters.

7.1. Preparations

Smartscope is both charged and connected to PC (Personal Computer) using the provided cradle. When Smartscope is not used, it may be stored in the cradle. Storing device in the cradle is not harmful for the battery.

Device can be connected to the cradle with optics attached.

7.2. Connection to a PC

Image data transfer method to PC is similar as with a digital camera.

When connected to a PC running Microsoft Window Vista®, Windows 7® or Windows 8® operating system displays query for AutoPlay. It is possible to select appropriate image viewing program or simply open the folder to view and then store files to the hard disk of the PC.

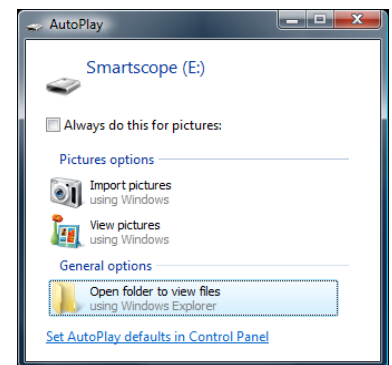

Writing to the memory card from PC is not enabled by default.

In case device has WIFI functionality, USB write protection must be turned off. WIFI enables wireless image transfer from camera to PC.

For WIFI installation instructions refer to Appendix C.

7.2.1. Pay-per-study

In case camera is in pay-per-study mode, images can be viewed only with Optomed Workstation Software. There are no other changes in camera functionality.

7.3. Basic use – starting up, shutting down and taking an image

Device is powered on by pressing left soft key.

It is possible to capture both still images and video. Image capture mode is changed from camera menu (optics specific tab) that opens by pressing right soft key for 1s.

Still image is captured using the dual action shutter to the second position. Video is captured by keeping the dual action shutter pressed down in the second position.

Taken image will stay on display until it is cleared by pressing right or left soft key. Image can be zoomed in instant preview by pressing middle key. There are four zoom levels. Pressing middle key activates the next level. Move around the image by using arrow keys.

To transfer images to a PC, place device to the cradle. The image transfer and charging is indicated with green and blue LED-lights and text on LCD-screen. In case the WIFI connection is active images are transferred to the PC automatically.

Smartscope verifies if image data is erased when:

- Device is powered on from power off mode or power save mode
- Device is removed from the cradle

It is recommended that image data storage is always erased with a new patient.

Device is powered off by keeping left soft key pressed down over 1 second.

NOTE:

When device is powered on, powered off or goes to standby mode the camera focus motor may make a sound. This sound is normal and is not a sign of any damage or problem.

7.4. Attaching and detaching optics module

NOTE:

Optic modules used with Optomed Smartscope M5 must include text "SMARTSCOPE". It is not allowed to attach other objects to the bayonet connector.

Optics is attached by placing it in front of the bayonet area of the device. Three bayonet legs are placed on the holes and optics is pressed firmly to the device:



Optics is released by sliding release button that is located in front of the device above the dual action shutter.

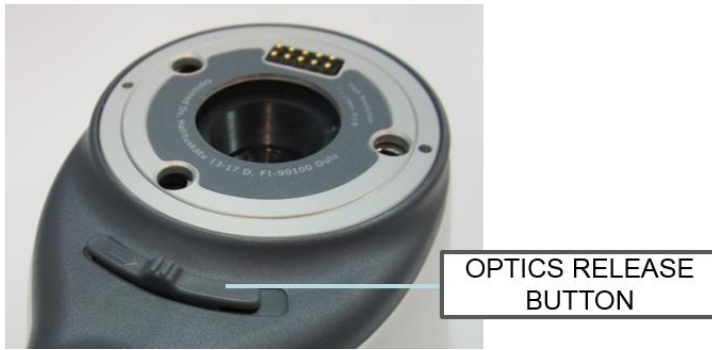

7.5. Device Menu

Menu is opened by pressing right soft key  for 1s.

Menu has seven tabs (settings page). One is for device settings such as language selection. There is one tab for retinal imaging (EY), fundus angiogram imaging (FA), anterior eye imaging (ES), ear imaging (OT), skin imaging (SK) and general imaging (DF).

Arrow keys are used to move between tabs: use arrow key up until tab is active and use left and right arrow keys to change active tab. Light blue color indicates active tab.

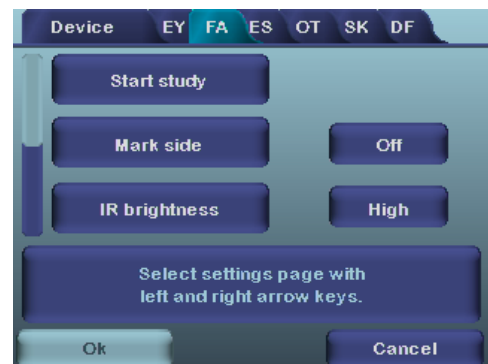

Arrow keys change values in the menu. Active value is indicated with light blue color. Changed values are saved by using left soft key ("Ok") and cancelled by pressing the right soft key ("Cancel"). Some values are confirmed by pressing the Middle key.

Table below includes explanations of the Device settings tab:

Setting	Values (default bolded)	Purpose
Preview images	Ok	To preview the images on camera press middle button.
New patient folder	Ok	To create a new patient folder press middle button. New patient folder can also be created in live view by long pressing the middle key.
Erase image memory	Ok	Select middle button to erase images and videos from camera SD card.
Edit patient list	Ok	Press middle key to edit patient list
Patient information	On/Off	Enable or disable patient information linking
Display brightness	Low-Med- High	Use left and right arrow keys to adjust display brightness
Icons	On/Off	Show graphical icons when imaging.
Sounds	On/Off	When enabled, sound is played during image capture
Keyboard backlight	On/Off	When enabled, keyboard illumination is on
Select language	ENG -FIN-FRA-GER-ITA-JPN-POR-SPA-ZHO	Use left and right arrow keys to select camera language

USB write protection	On/Off	When enabled, writing to SD card is not allowed when device is in cradle. This feature helps prevent any viruses getting from PC to the camera. Note that if device contains WIFI card, during its setup or updating of its firmware, USB write protection need to be temporarily set off.
Video file format	MPEG4/MPEG1	Use left and right arrow keys to select video file format
Image transfer method	UMS/WIA	Use WIA for automatic and UMS for end-user activated image transfer. UMS can be used in most cases.
Restore factory Setting	Ok	To restore all settings menus to factory defaults. Activate using the middle key
Date	DD-MM-YYYY	Use up and down arrow keys to set date.
Time	HH:MM	Use up and down arrow keys to set time.
Camera SW version	Show camera SW version	Browse version information with left and right arrow key
Start query	Era./Fol./None	Choose the startup query between memory erase, new patient folder or no query at all.
Set data cable type	CRA/SLI	This feature is currently not available
Remote trigger	On/Off	This feature is currently not available

Preview images

Image preview is opened by selecting “Preview files” with a middle key. Images are browsed by using arrow keys. Display gives information about usage of the image preview.

Image can be zoomed while previewing by pressing middle key. Move around the image by pressing arrow keys. Change between the four zoom levels by pressing middle key.

Patient ID information can be edited in image browser.

New Patient Folder

A new patient folder is created by pressing middle key when the new patient folder selection is active in Device menu. A new patient folder can also be created by pressing Middle key for 3 seconds when in live view. If the current patient folder is empty a new folder cannot be created.

Erase Image Memory

Image memory can be erased by selecting “Erase Image Memory” in Device menu. This selection is activated by pressing middle key. The camera also prompts the question “Erase image memory?” when camera is powered on or removed from cradle.

Edit patient list

User can add or remove patients from patient list.

Patient information

Enable or disable patient information linking.

Display brightness

The Display brightness selection has three options: low, medium and high. Choose the suitable level of display brightness according to for example how the examination room is lit up.

Icons

The icons shown on camera screen can be enabled or disabled to the user's liking. The most essential icons such as Menu icon are always visible.

Sounds

By default the camera makes a sound during image capture. This sound can be turned off from Device menu.

Keyboard backlight

By default the camera keys have a backlight lit up when the camera is turned on. This light can be turned off from Device menu if it disturbs the user while taking images.

Language

Camera has nine (9) different languages the user can choose from. Default language is English and the language selection is always shown in English in menu. If language is changed camera has to be re-started.

USB write protection

USB write protection is on by default. When protection is on this feature will prevent any virus from entering the camera from a PC when connected to the cradle.

In case device has WIFI functionality, USB write protection must be turned off.

Video file format

Camera has two file formats that user can choose for videos: MPEG4 and MPEG1. MPEG4 is a higher quality file format but may not be viewed with all video players. MPEG1 format is more widely supported by different SW applications.

Image transfer method

There are three options for the image transfer method: UMS (USB Mass Storage), WIA (Windows Image Acquisition) and WIFI.

NOTE: WIFI supported only if device has WIFI functionality.

Restore factory settings

Press middle key to restore factory defaults selection.

Date

Press middle key to change date settings. Date can be set using the up and down arrow keys. Move between day, month and year by pressing the left and right keys. Date format is DD MM YYYY for Finnish, German, French, Italian, Spanish and Portuguese. Date format is MM DD YYYY for Japanese and Chinese.

Time

Press middle key to change time settings. Time can be set using the up and down arrow keys. Move between hours and minutes by pressing the left and right arrow keys.

Camera SW version

This item in Device menu tells the camera SW version.

Start query

User can choose start-up query between erasing images, creating new patient folder or no query at all. When erasing images is chosen as the query the camera will prompt user on start-up whether all images and videos shall be deleted. When new patient folder query is chosen the camera will ask if a new patient folder shall be created upon start-up to prevent from mixing images with previous patient. If no query is selected then camera will go directly to live view upon start-up.

7.6. Patient editor

Patient information usage can be enabled / disabled. There can be maximum 500 patients on the list. Name of the patient is shown in low right hand side above right soft key, if current folder is linked to a patient.

7.6.1. Adding new patient

User can add new patient from Device menu by selecting Edit Patient list. User can add Patient ID and Patient name after choosing New patient. New patient can be added also after creating new folder.

7.6.2. Patient folder linking

User can link or unlink patient to/from current folder (not earlier ones). It is possible to link 5 folders to each patient.

Linking can be done:

1. Answering yes when powering on or lifting device from cradle,
2. Selecting erasing image memory from menu,
3. Choosing Link in image browser, when folders and files are visible. Link key is grey and unresponsive if current folder is not chosen. After folder is linked to a patient, folder is named by the patient,
4. Creating new folder by long pressing middle key or from menu.

Linking can be done:

1. Choosing Link in image browser, when folders and files are visible. Link key is grey and unresponsive if current folder is not chosen.

NOTE: Exiting from image browser is done by pressing left key.

7.6.3. Patient list exporting

User can export patient list via WIFI. New file is created containing patient list with 16 kBytes of padding bytes added to the end of file. File is named pehhmmss.jpg (hh is current hours, mm minutes and ss seconds). File is written under DCIM folder in SD card. File is exported over WIFI.

Patient list can be exported also via USB. Patient list is written as text file (patexp.txt) to SD card root. If patient list is modified in camera (new patient created) or SD card is erased, patient list is updated.

7.7. Adjusting focus and automatic focus

Camera has an autofocus function where camera finds correct focus place automatically. For EY3 square indicator appears when focusing is finished. For ES2, OT1 and SK1 focus window turns green when focusing is finished. Automatic focusing start when shutter button is pressed half way down. Focus mode can be changed by pressing right soft key.

Image focus can be adjusted manually by pressing arrow keys up and down. When focus mode is set to manual a diopter scale is visible on the screen.

7.8. Reset button

Reset button can be used if device behavior is abnormal.
Reset button is located in a small opening under display.
Button is marked with circle. 

Reset button can be pressed with a thin object such as a paper clip.
Button needs to be pressed for over 7 seconds.



8. Retinal imaging using optics module EY3

Optomed Smartscope M5 EY3 digital ophthalmic camera is intended to capture digital images and video of the fundus of the human eye. The device set for retinal imaging consists of:

- Camera handset M5
- Attachable ophthalmic lens EY3
- Eye cup for EY3
- Cradle for charging and image transfer

EY3 is intended for non-mydratiac imaging. This means that infrared is used for targeting image to the eye fundus and visible light is flashed when image is taken. Pupil does not respond to the infrared light so examination is convenient for the patient. Constant illumination can be selected from device menu if mydratiac drops are used. Pictures can also be taken using infrared light for both aiming and capturing.

STEPS FOR RETINAL IMAGING:

1. The examination room should be as dark as possible.
2. Both the patient and the examiner shall be seated while taking the images. Patient is asked to look at a target in a wall 2-3 meters behind the operator (patient's eye targets to infinity and stays still).
3. Either autofocus or manual focus can be used. Autofocus range is -11 to +3 diopters.

If patient has a refractive error and autofocus is off, focus need to be adjusted:

- Hyperopia: camera is focused to distance by pressing arrow key up. One click of the key is approximately 2 Dioptres.
 - Myopia: camera is focused closer by pressing arrow key down. One click of the key is approximately 2 Dioptres.
4. Aiming light is turned on by pressing the shutter key (in front of the device) half way down or by pressing the left soft key.
 5. Capturing light is adjusted using left and right arrow key. There are brightness levels from 0 to 10, default value is 5, and typical levels are from 2 to 8.

When using IR/White capture mode changing illumination brightness affects only the white capturing flash. If using IR/IR or White/White both aiming and capturing light are changed.

6. Approaching the eye is started from 10 centimeters (4 inch) distance. Patient is asked to look at a target in a wall 2-3 meters behind the operator (patient's eye targets to infinity and stays still). Pupil is approached until the reflection from the eye fundus can be seen. The right imaging distance is about 2 cm (0,8 inch). Silicone support must be compressed approximately half way down.

Camera is stabilised by keeping the outer side of the hand against the patient's forehead. Example of the correct usage position is shown below:



7. Still image is captured by pressing the shutter button all the way down. If half press capture is enabled, still image can be captured by pressing shutter button half way. Taken image is displayed on screen until user clears the image by pressing shutter button, left or right soft key.

Instant review can be enabled/ disabled in the Smartscope EY3 optics menu.

8. Image can be zoomed in instant preview by pressing middle key. There are four zoom levels (1, 2, 4, 8). Pressing middle key activates the next level. Move around the image by using arrow keys. Scroll between images by using left and right arrow keys.
9. Video is captured by keeping shutter button down. If half press capture is enabled, video image can be captured by pressing shutter button half way. Video capturing is finished by pressing shutter button all the way down.
10. If multiple patients are examined during one session, new file folder is created for each patient by pressing middle key for over 3 seconds.
11. Transfer images to a PC after capturing images. Images are transferred to the PC when camera is placed to the cradle or if a WIFI connection is active. Smartscope works as any other digital camera.
12. To erase the image/video manually, choose Menu, then Preview Images. There will be an option to erase a specific image or a specific folder.
13. When camera is removed from the cradle it verifies image data storage erase. It is recommended that image data storage is always erased before images are captured of a new patient.

The camera keys function as shown in image below when EY3 optics module is attached:

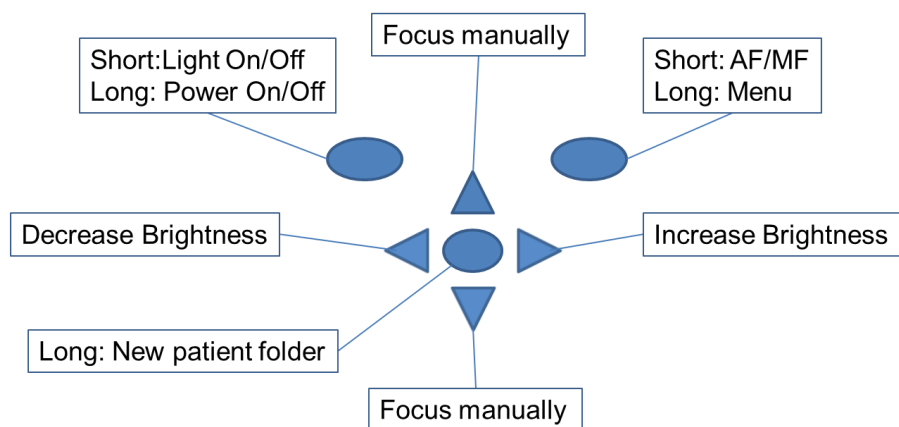

Below table provides explanations for the key functions:

Key	Press	Function	Explanation
Left soft key	Short	IR On / Off	The aiming light can be turned on and off by pressing Left soft key. The aiming light (IR or white) can also be turned on by half pressing the shutter button.
	Long	Power On / Off	Camera is powered on and off by pressing the Left soft key for longer than 2s.
Right soft key	Short	Auto / Manual focus	Switch between focus modes by pressing Right soft key. Manual focus is on by default. Autofocus range is -11 to +3 diopters.
	Long	Open Menu	Enter camera menu by pressing Right soft key for longer than 1s.
Middle key	Long	New patient folder	If multiple patients are examined during a same session, it is recommended to create a new file folder for each patient's images. New folder is created by pressing middle key for 3 seconds. Icon P at the top of the screen indicates number of the current patient folder. If the current folder does not have any images in it, a new folder cannot be created.
Left/Right arrow	-	Change brightness	Use left and right arrow keys to adjust capture light brightness. Aiming light brightness is adjusted in menu.
Up/Down arrow	-	Focus manually	When manual focus is active use up and down arrow keys to focus. Press arrow key up when patient has myopia. Press arrow key down when patient has hyperopia.

Table below includes explanations of the EY settings tab for retinal imaging:

Setting	Values (default bolded)	Purpose
Capture mode	Still / Video	Use left and right arrow keys to move between still capture and video capture.

Half press capture	On/Off	Enable capture by pressing shutter button half way.
Mark side	On/Off	Mark side of the eye to the image data.
IR brightness	Low/High	Aiming light brightness.
Red-free	On/Off	Saves a copy of an eye image using green color channel only.
Save IR image	On/Off	Saves an image taken with IR light in addition to white light image when turned on.
Low red	On/Off	Capture red reduced copy in addition to normal fundus image.
Illumination mode	IR/Wh, IR/IR, Wh/Wh	Use left and right arrow keys to select aiming and capture light source.
Automatic IR contrast	On/Off	Enable automatic IR contrast
Target blinking	On / Off	Fixation target light can be set to constant if needed.
Capture setting in image	On/Off	Enable or disable writing of capture settings to image.
Instant Review	On/Off	Instant review can be ON/OFF according to user need, as available in EY Optics menu. Instant review image can be changed from left and right arrow keys.

Capture mode

Both still images and video can be taken with the Smartscope M5 camera. When taking video the shutter button must be held down while taking the video. The video recording will stop once the shutter button is released.

Half press capture

It is possible to take images and video by pressing shutter button half way.

Marking side

It is possible to mark which eye was imaged. Marking side is enabled from the menu. When On side is marked to the file name and to the image. For video files, side is always marked only to the file name.

When marking side is enabled, camera verifies side after each captured image.

Identifiers used for eye images are OS for left and OD for right.

IR brightness

It is possible to set the aiming light brightness.

Save Red-free

If red-free image is enabled from menu, then camera will save a picture using only green channel at the same time when saving original picture.

Save IR image

If Save IR image is enabled from menu the camera will save an image taken with IR image in addition to saving a colour image taken with white light.

Low red

It is possible to capture red reduced image.

Illumination mode

Illumination mode can be set to IR/White, IR/IR or White/White. In IR/White mode aiming is done using infrared light and image is captured using white light. The pupil does not react to infrared light and thus it is recommended to use IR/White mode whenever possible. In IR/IR mode both aiming and image capture are done with infrared light. In White/White mode aiming and image capture are done with white light

Camera stores selected menu settings when it is powered off.

Automatic IR contrast

Automatically adjust infrared live view brightness and contrast according to image content. Improves visibility of fundus features during aiming. Same contrast and brightness settings are applied to IR still captures.

NOTE: In IR/IR mode, IR brightness adjustment does not always directly affect brightness on screen when automatic contrast is enabled. This happens because automatic contrast feature always tries to adjust screen brightness to same level. IR brightness setting still works, but the effect is only visible when adjustment range of automatic contrast adjustment runs out. It is advisable to use highest brightness that does not cause image saturation (pink or white “washed out” effect).”

Target blinking

By default the fixation target light is on with blinking illumination. If patient cannot keep their eye targeted well the light can be changed to constant to help focus on the target light.

Capture setting in image

It is possible to write brightness and diopter settings to image.

Instant review

Instant review can be ON/OFF according to user need, as available in EY Optics menu. When the reviewing zoom level is 1x, user can change the image to be reviewed with left and right arrow keys. Images are in showing order Normal, Low-red, Red-free, IR.

NOTE: Camera stores selected menu settings when it is powered off.

9. Eye imaging using anterior ophthalmic module Smartscope ES1/ES2

Optomed Smartscope ES1/ES2 is intended to capture images and video of the surface of the human eye and surrounding areas. The device set for anterior ophthalmic imaging consists of:

- Camera handset M5
- Attachable anterior ophthalmic lens ES1/ES2
- Cradle for charging and image transfer

Smartscope ES1/ES2 optics module has two light sources, white and cobalt blue light. User can choose between the light sources by pressing middle key when ES1/ES2 module is attached. Cobalt blue light enables taking fluorescent pictures of the surface of the eye to reveal any cuts or defects.

STEPS FOR EYE SURFACE IMAGING:

1. After ES1/ES2 optics module is attached the light source is chosen by pressing middle key.
2. Still or video image is selected. Selection is made in ES menu.
3. It is recommended to use autofocus.
4. Aiming light is turned on by pressing the shutter key (in front of the device) half way down.
5. Light is adjusted using left and right arrow key. There are altogether 10 brightness levels. Default value is 5. Suitable illumination is typically 2 to 8.
6. Place the optics module cup on patient's eye. Patient can be asked to look at different directions depending on what area of the eye needs to be captured.

Camera is stabilised by keeping the outer side of the hand against the patient's forehead. Example of the correct usage position is shown below:



7. Still image is captured by pressing the shutter key all the way down. If half press capture is enabled, still image can be captured by pressing shutter button half way. Taken image is displayed on screen until user clears the image by pressing shutter button, left or right soft key.

Instant review can be enabled/ disabled in the Smartscope ES1/ES2 optics menu.

8. Image can be zoomed in instant preview by pressing middle key. There are four zoom levels (1, 2, 4, 8). Pressing middle key activates the next level. Move around the image by using arrow keys. Scroll between images by using left and right arrow keys.
9. Video is captured by keeping shutter button down. If half press capture is enabled, video image can be captured by pressing shutter button half way. Video capturing is finished by pressing shutter button all the way down.
10. If multiple patients are examined during one session, new file folder is created for each patient by pressing middle key for over 3 seconds.
11. Transfer images to a PC after capturing images. Images are transferred to the PC when camera is placed to the cradle or if a WIFI connection is active. Smartscope works as any other digital camera.
12. Erase manually image / video by choosing Menu – Preview images. There can be chosen either the specific image or the specific folder to be erased.
13. When camera is removed from the cradle it verifies image data storage erase. It is recommended that image data storage is always erased before images are captured of a new patient.

Camera keys function as shown in image below when ES1/ES2 optics module is attached:

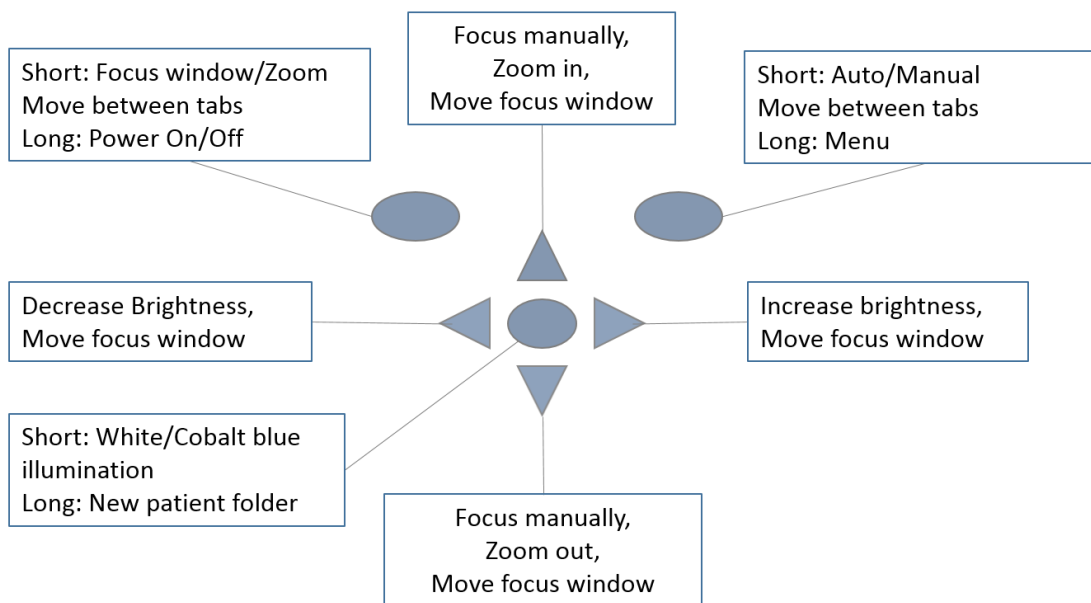

Below table provides explanations for the key functions:

Key	Press	Function	Explanation
Left soft key	Short	Edit focus window/ Activate Zoom	When focus window is visible it is possible to move it using arrow keys to better capture the wanted area.

			Digital zoom can be used for close up of features and image focus. Zoom value is saved to camera memory.
	Long	Power On / Off	Camera is powered on and off by pressing the Left soft key for longer than 2s.
Right soft key	Short	Auto / Manual focus / Activate Zoom	Switch between Auto and Manual focus by pressing Right soft key. Press Right soft key to activate zoom function. Digital zoom can be used for close up of features and image focus. Zoom value is saved to camera memory.
	Long	Open Menu	Enter camera menu by pressing Right soft key for longer than 1s.
Middle key	Short	White / Blue	Choose between white and blue illumination by pressing left soft key. Blue light can be used with fluorescent applied on the eye to reveal any cuts or defects.
	Long	New patient folder	If multiple patients are examined during a same session, it is recommended to create a new file folder for each patient's images. New folder is created by pressing middle key for 3 seconds. Icon P at the top of the screen indicates number of the current patient folder. If the current folder does not have any images in it, a new folder cannot be created.
Left/Right arrow	-	Change brightness	Use left and right arrow keys to adjust capture light brightness.
	-	Move AF window	Move focus window left and right after pressing Middle key to activate. Window returns to original position when camera is put to cradle, turned off or optics module detached.
Up/Down arrow	-	Focus manually	Use up and down arrows to focus manually.
		Zoom In / Out	Zoom in using arrow key up. Zoom out using arrow key down. There are four zoom levels: 1, 2, 4 and 6. Zoom value is saved to camera memory.
	-	Move AF window	Move focus window left and right after pressing Middle key to activate.

Table below includes explanations of the ES settings tab for anterior eye imaging:

Setting	Values (default bolded)	Purpose
Capture mode	Still / Video	Use left and right arrow keys to choose between still capture and video capture.
Half press capture	On/Off	Enable capture by pressing shutter button half way.
Focus windows	Visible /Hidden	Use left and right arrow keys to choose between having focus window visible or hidden.
Mark side	On/Off	Mark side of the eye to the image data.
Zoom cropping	On/Off	When turned on camera will save the zoomed area only. When turned off camera will save the whole image area even when zoom is used.
Instant Review	On/Off	Instant review can be ON/OFF according to user need, as available in ES Optics menu. Instant review image can be changed from left and right arrow keys.

Capture mode

Both still images and video can be taken with the Smartscope M5 camera. When taking video the shutter button must be held down while taking the video. The video recording will stop once the shutter button is released.

Half press capture

It is possible to take images and video by pressing shutter button half way.

Focus Window

Focus Window helps user position the image. Focus Window can be moved on the screen by using Left soft key and then using the arrow keys when aiming.

Marking side

It is possible to mark which eye was imaged. Marking side is enabled from the menu. When On side is marked to the file name and to the image. For video files, side is always marked only to the file name.

When marking side is enabled, camera verifies side after each captured image.

- Identifiers used for normal eye images are OS for left and OD for right.
- Identifiers used for red-free images are SG for left and DG for right.
- Identifiers used for save IR images are SI for left and DI for right.
- Identifiers used for color corrected images are SC for left and DC for right.

Zoom cropping

With zoom cropping on the camera will save the zoomed area instead of the whole image area. By default zoom cropping is turned off and camera will save the whole image area instead of the area that is visible on the camera screen when user has zoomed in.

Instant review

Instant review can be ON/OFF according to user need, as available in ES Optics menu. When the reviewing zoom level is 1x, user can change the image to be reviewed with left and right arrow keys. Images are in showing order Normal, Low-red, Red-free, IR.

NOTE: Camera stores selected menu settings when it is powered off.

10. Ear imaging using otoscopic lens Smartscope OT1

Optomed Smartscope OT1 digital otoscopic module is intended to capture digital images and video of the ear canal and tympanic membrane. Device set for otoscopic imaging consists of:

- Camera handset M5
- Attachable otoscopic lens OT1
- Otosopic specula
- Air pump

Otoscope can be used with widely available type “beta-Heine/allspec” speculas.

Steps for capturing ear images are:

1. Attach otoscopic lens. Press firmly until you hear a clicking sound to make sure module connects properly.
2. Attach specula.
3. Start illumination by pressing shutter half way down. Adjust illumination by using left and right arrow keys.
4. Adjust focus if needed by pressing arrow keys up and down. It is recommended to use autofocus. Automatic focusing starts when shutter is pressed half way down (lower right corner of the display shows text “Auto”). If pressing shutter button does not activate automatic focusing, autofocus needs to be activated from right soft key.
5. Use digital zoom for close up of features if needed: press left soft key to activate Zoom (lower left corner shows text “Zoom”) and arrow key up or down to adjust zoom. There are four zoom levels: 1, 2, 4 and 6. Press right soft key to re-activate focus if needed.
6. Due to slight differences between individual specula the image area may not be completely visible or tilted to the side when using zoom. Press left key to access “Capture area” function. Then you can move the image area to the centre of the screen. If capture area is edited this setting is saved. The centring can be reset by restoring factory settings.
7. Capture image by pressing shutter button all the way down. Still image is captured by pressing the shutter key all the way down. Video is captured by keeping shutter down. Taken image is displayed on screen until user clears the image by pressing shutter, left or right soft key. Image can be zoomed in instant preview by pressing middle key. There are four zoom levels. Pressing middle key activates the next level. Move around the image by using arrow keys.

Instant review can be enabled/ disabled in the Smartscope OT1 optics menu.

8. If multiple patients are examined during one session, create a new file folder for each patient by pressing middle key for over 3 seconds.

- Transfer images to a PC after capturing images. Images are transferred to the PC when camera is placed to the cradle or if a WIFI connection is active. Smartscope works as any other digital camera.

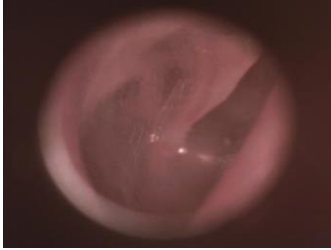

Camera keys function as shown in image below when OT1 optics module is attached:

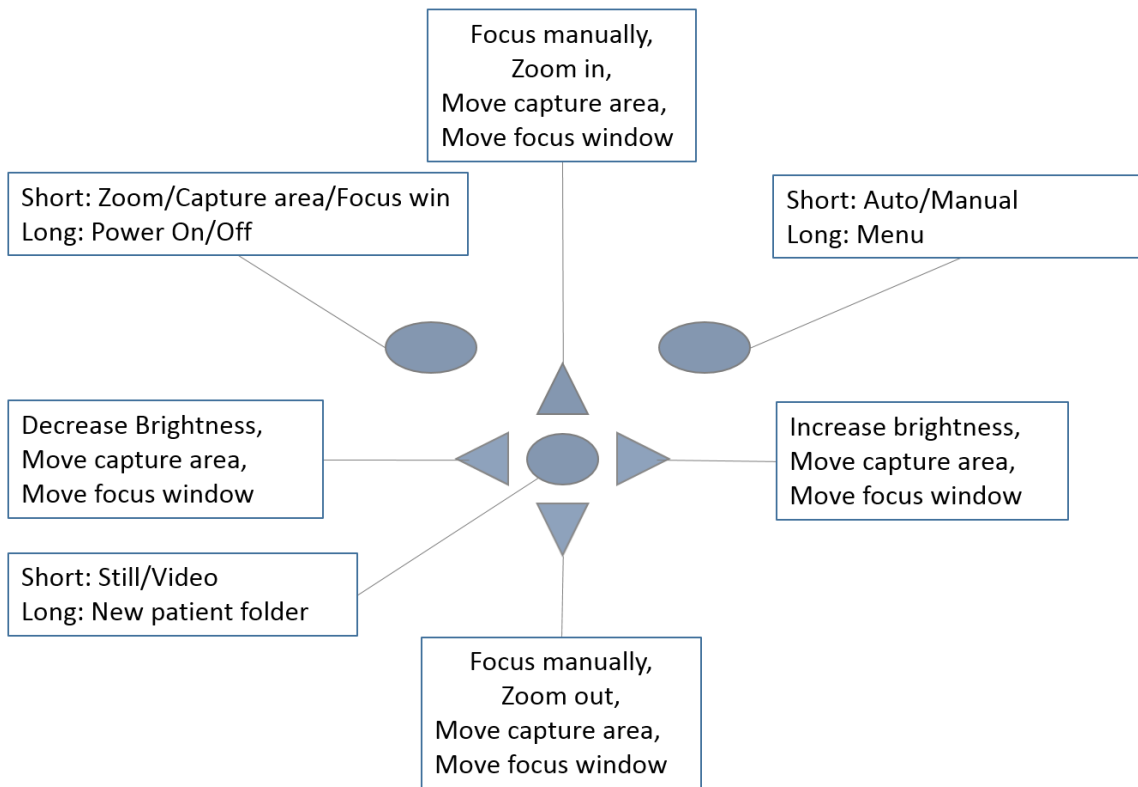

Below table provides explanations for the key functions:

Key	Press	Function	Explanation
Left soft key	Short	Zoom	Press Left soft key to activate zoom function. Digital zoom can be used for close up of features and image focus. Icon "Zoom" displayed in lower left corner of display when active.
		Edit capture area	Due to differences between specula the image area can be tilted to the side of the screen when using small specula. Press Left soft key to enter "Capture area"

			function and move image area to center of the screen. If capture area is moved the location is saved.
		Move focus window	When focus window is visible it is possible to move it using arrow keys to better capture the wanted area.
	Long	Power On / Off	Camera is powered on and off by pressing the Left soft key for longer than 2s.
Right soft key	Short	Auto / Manual focus	Switch between Auto and Manual focus by pressing Right soft key.
	Long	Open Menu	Enter camera menu by pressing Right soft key for longer than 1s.
Middle key	Short	Still / Video	Choose between still image and video shooting by pressing Middle key.
	Long	New patient folder	If multiple patients are examined during a same session, it is recommended to create a new file folder for each patient's images. New folder is created by pressing middle key for 3 seconds. Icon P at the top of the screen indicates number of the current patient folder. If the current folder does not have any images in it, a new folder cannot be created.
Left/Right arrow	-	Change brightness	Use left and right arrow keys to adjust capture light brightness.
	-	Move focus window	Move focus window left and right after pressing Left soft key to activate. Window returns to original position when camera is put to cradle, turned off or optics module detached.
	-	Move capture area	Use left and right arrow keys to adjust capture area to center of screen after activating with Left soft key.
Up/Down arrow	-	Focus manually	Use up and down arrows to focus manually.
	-	Zoom In / Out	Zoom in using arrow key up. Zoom out using arrow key down. There are four zoom levels: 1,2,4 and 6. Zoom value is saved to camera memory.
	-	Move focus window	Move focus window up and down after pressing Left soft key to activate.
	-	Edit capture area	Use up and down arrow keys to adjust capture area to center of screen after activating with Left soft key.

Table below includes explanations of OT settings tab for ear imaging:

Setting	Values (default bolded)	Purpose
Capture mode	Still / Video	Use left and right arrow keys to choose between still capture and video capture.
Half press capture	On/Off	Enable capture by pressing shutter button half way.
Focus window	Visible /Hidden	Use left and right arrow keys to choose between having focus window visible or hidden.
Mark side	On/Off	Mark side of the ear to the image data.
Zoom cropping	On/Off	When turned on camera will save the zoomed area only. When turned off camera will save the whole image area even when zoom is used.
Instant Review	On/Off	Instant review can be ON/OFF according to user need, as available in OT Optics menu.

Capture mode

Both still images and video can be taken with the Smartscope M5 camera. Capture mode can be chosen in OT menu and when using OT1 otoscopic module from Middle key. When taking video shutter button must be held down while taking the video. Video recording will stop once the shutter button is released.

Half press capture

It is possible to take images and video by pressing shutter button half way.

Focus Window

Focus Window helps user position the image. Focus Window can be moved on the screen by first pressing Left soft key until text "Focus win" appears in lower left corner of display and then using the arrow keys when aiming.

Marking side

It is possible to mark which ear was imaged. Marking side is enabled from the menu. When enabled, side is marked to the file name and to the image.

When marking side is enabled, camera verifies side after each captured image.

Identifiers used for ear images are LE (left) and RI (right).

Zoom cropping

By default zoom cropping is on and camera will save the zoomed area instead of the whole image area. When zoom cropping is off, camera will save the whole image area.

Instant review

Instant review can be ON/OFF according to user need, as available in EY Optics menu. When the reviewing zoom level is 1x, user can change the image to be reviewed with left and right arrow keys. Images are in showing order Normal, Low-red, Red-free, IR.

Camera stores selected menu settings when it is powered off.

11. Skin Imaging using dermatoscopic optics module SK1

With attachable skin optics module SK1 camera can be used for capturing digital images and video of the skin.

Steps for capturing skin images are:

1. Attach skin optics module. Press firmly until you hear a clicking sound to make module connect properly.
2. Press module gently to the skin. You may use immersion fluids such as aqueous disinfectant.
3. Adjust illumination by using left and right arrow keys.
4. Adjust focus if needed by pressing arrow keys up and down. It is recommended to use autofocus. Automatic focusing starts when shutter is pressed half way down. If pressing shutter does not activate automatic focusing, autofocus needs to be activated from right soft key.
5. Use digital zoom for close up of features if needed: press left soft key to activate Zoom (lower left corner shows "Zoom") and arrow key up or down to adjust zoom. There are four zoom levels: 1, 2, 4 and 6. Press right soft key to re-activate focus if needed. Zoom value is saved to camera memory.
6. Activate portrait mode by pressing middle key when taking an image of a larger area such as head, whole arm or the whole body. The icon on the upper right corner of screen now says "P" (Portrait) instead of "S" (Skin).
7. Capture image by pressing shutter button all the way down. Still image is captured by pressing the shutter key all the way down. Video is captured by keeping shutter down. Taken image is displayed on screen until user clears the image by pressing shutter, left or right soft key. Image can be zoomed in instant preview by pressing middle key. There are four zoom levels. Pressing middle key activates the next level. Move around the image by using arrow keys.

Instant review can be enabled/ disabled in the Smartscope SK1 optics menu.

8. If multiple patients are examined during one session, create a new file folder for each patient by pressing middle key for over 3 seconds.
9. Transfer images to a PC after capturing images. Images are transferred to the PC when camera is placed to the cradle or if a WIFI connection is active. Smartscope works as any other digital camera.

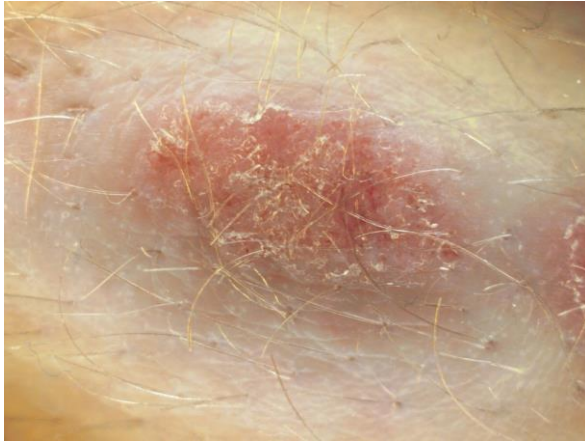

Camera keys function as shown in image below when SK1 optics module is attached:

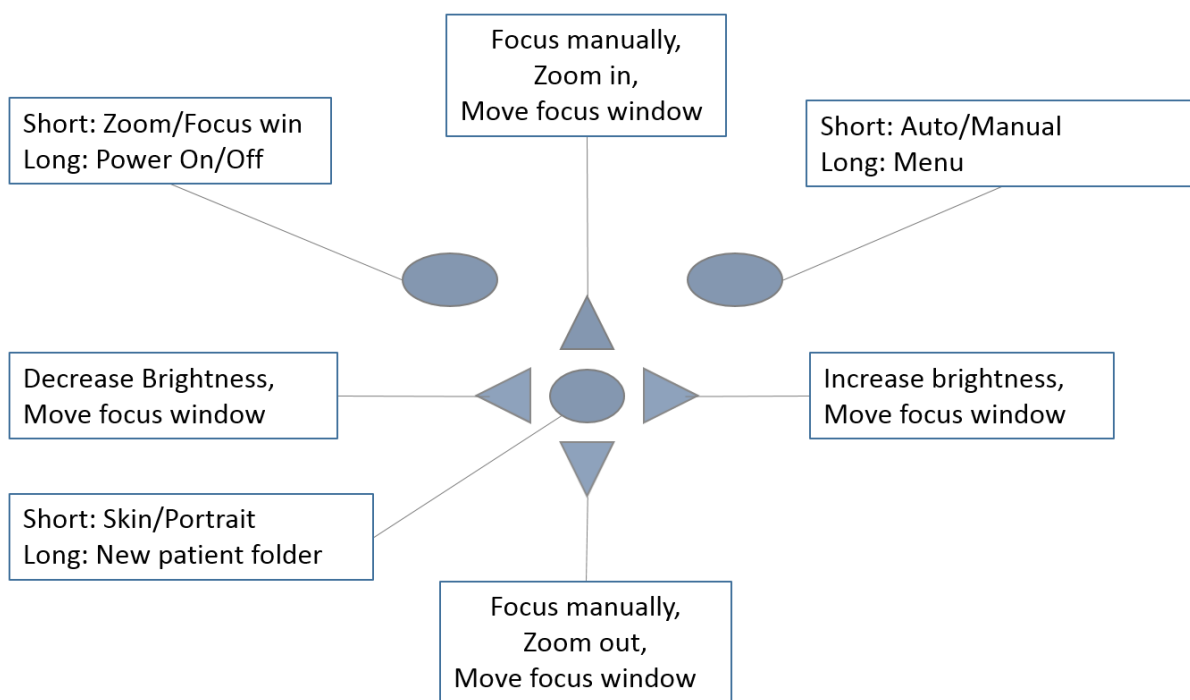

Below table provides explanations for the key functions:

Key	Press	Function	Explanation
Left soft key	Short	Activate Zoom	Press Right soft key to activate zoom function. Digital zoom can be used for close up of features and image focus. Icon "Zoom" displayed in lower left corner of display when active. Zoom value is saved to camera memory.
		Move focus window	When focus window is visible it is possible to move it using arrow keys to better capture the wanted area.
	Long	Power On / Off	Camera is powered on and off by pressing the Left soft key for longer than 2s.
Right soft key	Short	Auto / Manual focus	Switch between Auto and Manual focus by pressing Right soft key.

	Long	Open Menu	Enter camera menu by pressing Right soft key for longer than 1s.
Middle key	Short	Skin / Portrait	Press left soft key to switch between Skin and Portrait modes. When taking an image of the skin close up use Skin mode. When taking an image of larger area use Portrait mode.
	Long	New patient folder	If multiple patients are examined during a same session, it is recommended to create a new file folder for each patient's images. New folder is created by pressing middle key for 3 seconds. Icon P at the top of the screen indicates number of the current patient folder. If the current folder does not have any images in it, a new folder cannot be created.
Left/Right arrow	-	Change brightness	Use left and right arrow keys to adjust capture light brightness.
	-	Move focus window	Move focus window left and right after pressing Left soft key to activate. Window returns to original position when camera is put to cradle, turned off or optics module detached.
Up/Down arrow	-	Focus manually	Use up and down arrows to focus manually.
	-	Zoom In / Out	Zoom in using arrow key up. Zoom out using arrow key down. There are four zoom levels: 1,2,4 and 6. Zoom value is saved to camera memory.
	-	Move focus window	Move focus window up and down after pressing Left soft key to activate.

Table below includes explanations of the SK settings tab for skin imaging:

Setting	Values (default bolded)	Purpose
Capture mode	Still / Video	Use left and right arrow keys to choose between still capture and video capture.
Half press capture	On/Off	Enable capture by pressing shutter button half way.
Focus window	Visible /Hidden	Use left and right arrow keys to choose between having focus window visible or hidden.
Skin body map	On/Off	Mark body part to image and image name.
Skin / Portrait	Skin /Portrait	Select skin when taking close-up pictures of skin. Select Portrait when taking portrait pictures.
Zoom cropping	On/Off	When turned on camera will save the zoomed area only. When turned off camera will save the whole image area even when zoom is used.
Instant Review	On/Off	Instant review can be ON/OFF according to user need, as available in FA Optics menu.

Capture mode

Both still images and video can be taken with the Smartscope M5 camera. Capture mode can be chosen in SK menu. When taking video the shutter button must be held down while taking the video. Video recording will stop once the shutter button is released.

Half press capture

It is possible to take images and video by pressing shutter button half way.

Focus Window

Focus Window helps user position the image. Focus Window can be moved on the screen by first pressing left soft key until icon "Focus win" appears in lower left corner of display and then using the arrow keys when aiming.

Skin body map

Skin body mapping can be used when taking dermatoscopic images to mark on the image and image name the body part number which was imaged. Camera will display options of body parts after an image is captured. Choose the correct body part by using arrow keys and soft keys.

Skin / Portrait

This feature allows taking images from close up and from further away with the skin module. To take a close-up image choose "Skin" mode (this is on by default). To take an image of larger area such as the head choose "Portrait".

Zoom cropping

With zoom cropping on the camera will save the zoomed area instead of the whole image area. By default zoom cropping is on and camera will save visible area on the camera screen.

Instant review

Instant review can be ON/OFF according to user need, as available in EY Optics menu. When the reviewing zoom level is 1x, user can change the image to be reviewed with left and right arrow keys. Images are in showing order Normal, Low-red, Red-free, IR.

Camera stores selected menu settings when it is powered off.

12. General imaging without optics module

It is possible to take pictures using Smartscope M5 without any optics module. When taking images without additional optics, integration time that corresponds to the brightness of the image is adjusted using left and right arrow key. Indicator for integration time is shown at the bottom of the display.

Below picture shows the functions of camera keys when no optics is attached.

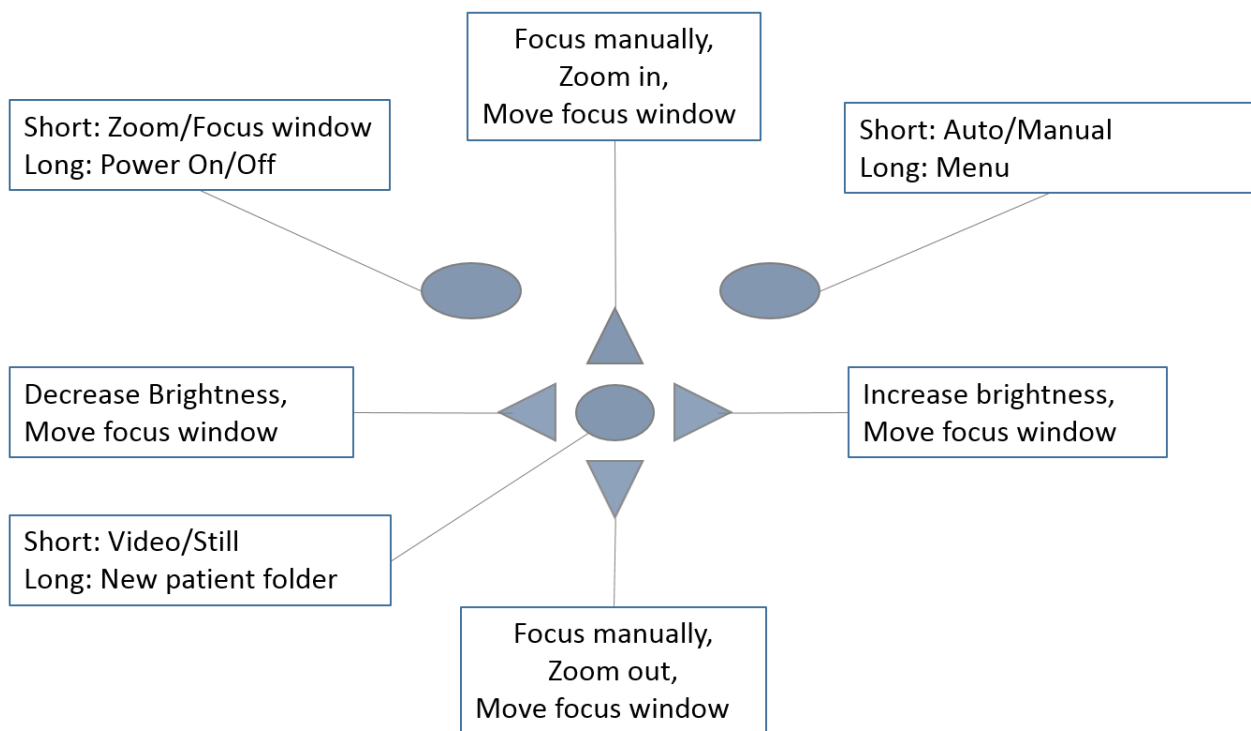

Table below provides explanations for the key functions.

Key	Press	Function	Explanation
Left soft key	Short	Edit focus window/ Activate Zoom	When focus window is visible it is possible to move it using arrow keys to better capture the wanted area. Digital zoom can be used for close up of features and image focus.
	Long	Power On / Off	Camera is powered on and off by pressing the Left soft key for longer than 2s.
Right soft key	Short	Auto / Manual focus	Switch between Auto and Manual focus by pressing Right soft key.
	Long	Open Menu	Enter camera menu by pressing Right soft key for longer than 1s.
Middle key	Short	Still / Video	Choose between still image and video shooting by pressing Middle key key.
	Long	New patient folder	If multiple patients are examined during a same session, it is recommended to create a new file folder for each patient's images. New folder is created by pressing middle key for 3 seconds. Icon P at the top of the screen indicates number of the current patient

			folder. If the current folder does not have any images in it, a new folder cannot be created.
Left/Right arrow	-	Change brightness	Use left and right arrow keys to adjust capture light brightness.
	-	Move AF window	Move focus window left and right after pressing Middle key to activate. Window returns to original position when camera is put to cradle, turned off or optics module detached.
Up/Down arrow	-	Focus manually	Use up and down arrows to focus manually.
	-	Zoom In / Out	Zoom in using arrow key up. Zoom out using arrow key down. There are four zoom levels: 1, 2, 4 and 6.
	-	Move AF window	Move focus window left and right after pressing Middle key to activate.

Table below includes explanations of the DF settings tab for general imaging:

Setting	Values (default bolded)	Purpose
Capture mode	Still / Video	Use left and right arrow keys to choose between still capture and video capture.
Half press capture	On/Off	Enable capture by pressing shutter button half way.
Focus window	Visible /Hidden	Use left and right arrow keys to choose between having focus window visible or hidden.
Zoom cropping	On/Off	When turned on camera will save the zoomed area only. When turned on camera will save the whole image area even when zoom is used.
Instant Review	On/Off	Instant review can be ON/OFF according to user need, as available in EY Optics menu. Instant review image can be changed from left and right arrow keys.

Capture mode

Both still images and video can be taken with Smartscope M5 camera. Capture mode can be chosen in DF menu. Shutter button must be held down while taking the video. Video recording will stop once shutter button is released.

Half press capture

It is possible to take images and video by pressing shutter button half way.

Focus Window

Focus Window helps user position the image. Focus Window can be moved on the screen by first pressing left soft key and then using the arrow keys when aiming.

Zoom cropping

By default zoom cropping is on and camera will save the zoomed area instead of the whole image area. When zoom cropping is off, camera will save the whole image area.

Instant review

Instant review can be ON/OFF according to user need, as available in EY Optics menu. When the reviewing zoom level is 1x, user can change the image to be reviewed with left and right arrow keys. Images are in showing order Normal, Low-red, Red-free, IR.

NOTE: Camera stores selected menu settings when it is powered off.

13. Error messages

Optomed Smartscope M5 will display error messages for the limitations of the usage. Error message is always displayed with explanatory message providing information about possible actions.

List of error messages:

Error message:	What to do:
Autofocus calibration needed	Please hold camera horizontal and press OK to calibrate.
Battery failure	Remove battery completely from camera. Re-install or replace.
Charging failure	Please remove and reconnect device to cradle.
Image counter full	Copy images to safe location and then choose Erase image memory from device menu.
Image storage not found	Please contact service for more information.
Light source temperature too high	Please wait for camera to cool down. Cooling may take several minutes.
Memory erasing failed	Please contact service for more information.
Memory full	Memory is full, store images and erase memory card.
Optic type not detected	Please re-attach optic.
Optic communication failed	Please re-attach optic.
Optic control failed	Please detach optic and restart camera.
Patient list upload failed	Please verify list against instructions.
System flash memory not available	Please contact service for more information.

14. Cleaning instructions

Optomed Smartscope M5 is a precision optics instrument that should be handled with care. Please note following cleaning instructions for camera and optics modules:

- Shut down device before cleaning it
- Remove cradle from mains before cleaning it
- Disinfect housing with soft cloth moistened with alcohol (e.g. 70% ethanol). Avoid touching System connectors in the handset and cradle.
- Lenses may be cleaned with cleaning cloth. Also moist-cleaning tissue such as Hama Pro-Optic® cleaning tissue can be used.

Optomed Smartscope is not intended to be sterilized.

Clean Eye optics (EY3) and Eye surface optics (ES1, ES2) eye cup before each use on a new patient:

- disinfect eye cup with soft cloth moistened with alcohol (e.g. 70% ethanol), or
- soak eye cup in glutaraldehyde based solution, or hydrogen peroxide and peracetic acid solution such as Erisan OXY+
- rinse the eye cup under running water
- dry the eye cup (e.g. with clean paper towel) before subsequent use

If replacement for eye cup (EY3) is needed, please contact Optomed or your own retailer.

Eye cup should be replaced if/when:

- eye cup is discolored
- eye cup form is deteriorated
- eye cup is shattered, cracked or disintegrated



WARNING:

Clean eye cup before each use on a new patient to avoid contamination.

15. Device maintenance

Optomed Smartscope contains rechargeable Ni-MH battery pack. Service life of the battery is approximately 1-2 years. Battery needs to be replaced on planned intervals. When battery is at end of its service life, usage time of the device goes down.

Appendix B gives instructions for battery replacement.

There are no other maintenance procedures that can be carried out by the user. All servicing and repairs other than replacing the battery must be carried out by Optomed or Optomed certified service facilities and service personnel. Optomed Oy will make available work instructions to repair those parts of medical electrical equipment that Optomed Oy has designated as repairable by service personnel.



CAUTION:

If there are breaks in the device covers or other visual defects, contact Optomed Customer Service or Optomed certified service facility.

16. Technical description

CAMERA:

Type:	OPTOMED SMARTSCOPE M5
Image sensor:	CMOS, 5.0 Megapixels
Image memory type:	2 GB, micro SD card or WIFI SDHC card.
Display:	2.4", TFT-LCD, 262 000 colors, antireflective coating
Image format:	JPEG (file extension: jpg)
Video format:	MPEG-4 and MPEG-1
Connectivity:	PC with USB port
Operating systems:	Windows XP®, Windows Vista®, Windows 7, Windows 8 No driver installation needed.
Dimensions:	82,30(w) x166,50(h) x 66,50(d) mm
Weight:	400 g
Battery:	Rechargeable Ni-MH Cylinder cell, HR4U 700 AAA, 4.8 V, 1.0 Ah User can change battery. Batteries provided by Optomed.
Usage time:	1h 30min with full battery



CHARGING CRADLE:

Type:	OPTOMED SMARTSCOPE CRADLE V1
Dimensions:	170(w) x 35(h) x 150(d) mm
Weight:	380 g
Switching power supply connected to cradle:	Type: CINCON TR10R090, Input: 100-240 V ~0.4A 47-63 Hz, Output: 9V, 1.1A, 10 W
USB cable:	Type A to mini B, high-speed, unshielded, length 1,8 m



CAUTION:

It is only allowed to attach Battery and Power source provided in the sales package into the Cradle. If you need replacement to the Battery or Power source, please contact Optomed Customer Service or your local Retailer.

NON-MYDRIATIC OPHTHALMIC MODULE CONNECTED TO SMARTSCOPE M5 CAMERA

Type: Smartscope EY3

Intended use: Digital ophthalmoscope. Intended to capture digital images and video of the fundus of the human eye.

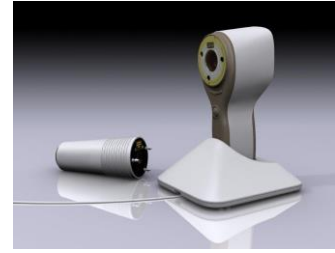

Illumination: Infrared LED for targeting
Visible white LED for photographing , 10 illumination brightness levels

Maximum Luminance output level towards eye: 0.0613 cd/cm²

Field of view: 45°
Dioptre compensation: - 20 D to + 20 D

Image resolution: 1920x1440 px

Dimensions: 132.1x55.2 mm
Weight: 180 g

EXTERNAL OPHTHALMIC MODULE CONNECTED TO THE SMARTSCOPE M5 CAMERA

Type: Smartscope ES1/ES2

Intended use: Digital eye anterior optics module. Intended to capture digital images and video of the surface of the human eye and surrounding areas.



Illumination: Visible white and cobalt blue LED for photographing, 10 illumination brightness levels

Maximum Luminance output level towards eye: 192 cd/cm²

Image resolution: 2560x1920 px

Dimensions: 79x70 mm
Weight: 90 g

DIGITAL DERMATOSCOPE SK1 CONNECTED TO THE M5 CAMERA

Type:	Smartscope SK1
Intended use:	Digital dermatoscope. Intended to capture images of the skin.
Illumination:	Light ring of 24 LEDs
Image resolution:	2560*1920 px
Image size on skin:	30 * 22 mm
Dimensions:	60x77mm
Weight:	150g



OTOSCOPIC LENS OT1 CONNECTED TO THE M5 CAMERA

Type:	Smartscope OT1
Intended use:	Imaging of ear canal and tympanic membrane
Image resolution:	2560 x 1920 pixels
Dimensions:	49.2x45.5 mm
Weight:	80 g
Main features:	Integrated LED illumination Insufflation port for pneumatic otoscopy Disposable and reusable speculum diameter range: 2,5-5



ENVIRONMENTAL CONDITIONS FOR USE, STORAGE AND TRANSPORTATION:

IP Code: IPX0 (Equipment not protected against the ingress of water)

Intended to be use indoors:

Temperature, use: + 10 °C to 35 °C
Relative humidity, use: 10 % to 80 %
Atmospheric pressure: 800 hPa to 1060 hPa
Please note also EMC information given in Annex A.

Temperature, storage: - 10 °C to 40 °C
Relative humidity, storage: 10 % to 95 %
Atmospheric pressure: 500 hPa to 1060 hPa

NOTE: If stored over 1 month, it is recommended to remove battery. Appendix B gives instructions for removing the battery.

Transported in protective aluminum carrying case:

Temperature: - 40 °C to + 70 °C
Relative humidity: 10 % to 95 %
Atmospheric pressure: 500 hPa to 1060 hPa
Sinusoidal vibration: 10 Hz to 500 Hz: 0,5 g
Shock: 30 g, duration 6 ms
Bump: 10 g, duration 6 ms



WARNING:

Do not leave the eye cup in direct sunlight as it may warm up and burn patients head when taking image.

SERIAL NUMBERING:

Year of manufacture can be found from the serial number (digits 3 to 4).

Serial number of the cradle is in a sticker attached to the underside of the cradle.

Serial numbers of the attachable optics modules are attached to the modules.

SW version is displayed in the device menu.

EXPECTED USAGE LIFE OF THE SMARTSCOPE:

There are no strict limitations about expected usage life of the Smartscope. Usage life is approximately five years.

INTELLECTUAL PROPERTY RIGHT INFORMATION:

Microsoft Window Vista®, Windows 7® and Windows 8® are trademarks of Microsoft Corporation.

Hama Pro-Optic is a trademark of Hama GmbH & Co KG.

Erisan OXY+ is a trademark of Farnos Ltd

PATENT NOTICE

This product is protected by the following patent numbers and their corresponding national rights: 122533, 107120, 119531, 120958, 2200498, 5171845, 5561130, 5658371, I468147, ZL200880101934.7, ZL200880112052.0, US 8,078,667 B2. Additional patent applications are pending.

TRADEMARK

Optomed Smartscope, its logos and other Optomed Smartscope brand trademarks and made names are registered or unregistered trademarks of Optomed Oy. All rights are reserved.

DISPOSING THE OPTOMED SMARTSCOPE M5:

Do not dispose Optomed Smartscope products as unsorted municipal waste. Prepare Optomed Smartscope products for reuse or separate collection as specified by Directive 2002/96/EC of the European Parliament and Council of the European Union on Waste Electronic and Electrical Equipment (WEEE). If this product is contaminated, this directive does not apply.

For more specific information, please contact Optomed Oy or your local retailer.

CONTACT

For after sales services please contact your local distributor.

If you need to contact Optomed Oy additional information can be obtained:

Optomed Oy Customer Service number: +358 20 741 3380

Optomed Oy Customer Service email: service@optomed.com

Latest version of User Manual can be found: www.optomed.com

17. Warranty

Optomed Oy gives device a 1 year warranty for the parts and labor. Warranty for battery is 6 months.

Submitting claim:

Any claim under this warranty must be submitted in writing before the end of warranty period to Optomed Oy. The claim must include a written description of the failure that the device have.

Warranty does not cover:

Products that have been subjected to abuse, accident, alternation, modification, tampering, misuse, faulty installation, lack of reasonable care, repair or service in any way that is not contemplated in the documentation of the product, or if the model or serial number has been altered, tampered with, defaced or removed. Warranty does not cover damage caused by dropping the device or damage caused by normal wearing. Any issue related to the stickers attached to the device coming off are not covered by warranty. Repair or service done by non Optomed certified service facility is not covered by warranty.

Appendix A

Electromagnetic compatibility information



MEDICAL ELECTRICAL SYSTEM needs special precautions regarding EMC and needs to be installed and put into service according to the EMC information provided.

Portable and mobile RF communications equipment can affect MEDICAL ELECTRICAL SYSTEM.

Optomed Smartscope M5 should not be used adjacent to or stacked with other equipment and that if adjacent or stacked use is necessary, the EQUIPMENT or SYSTEM should be observed to verify normal operation in the configuration in which it will be used.

Manufacturer's declaration – electromagnetic immunity:

SMARTSCOPE M5 is intended for use in the electromagnetic environment specified below. The customer or the user of the M5 should assure that it is used in such an environment.			
Immunity test	IEC 60601 test level	Compliance level	Electromagnetic environment – guidance
Electrostatic discharge (ESD) IEC 61000-4-2	±6 kV contact ±8 kV air	± 2 kV, ± 4 kV, ± 6 kV indirect contact ± 2 kV, ± 4 kV, ± 6 kV contact ± 2 kV, ± 4 kV, ± 8 kV air	Floors should be wood, concrete or ceramic tile. If floors are covered with synthetic material, the relative humidity should be at least 30 %.
Electrical fast transient/burst IEC 61000-4-4	±2 kV for power supply lines ±1 kV for input/output lines	±2 kV for AC power supply ±1 kV for serial cable	Mains power quality should be that of a typical commercial or hospital environment.
Surge IEC 61000-4-5	±1 kV line(s) to line(s) ±2 kV line(s) to earth	± 1 kV for AC power supply, 1 Phase without Protective Earth	Mains power quality should be that of a typical commercial or hospital environment.
Voltage dips, short interruptions and voltage variations on power supply input lines IEC 61000-4-11	<5 % U_T (>95 % dip in U_T) for 0,5 cycle 40 % U_T (60 % dip in U_T) for 5 cycles 70 % U_T (30 % dip in U_T) for 25 cycles <5 % U_T (>95 % dip in U_T) for 5 sec	Manufacturer's test shows conformance to the requirements of the IEC 61000-4-11/EN 61000-4-11	Mains power quality should be that of a typical commercial or hospital environment. If the user of the Smartscope M5 requires continued operation during power mains interruptions, it is recommended that the Smartscope M5 be powered from an uninterruptible power supply or a battery.
Power frequency (50/60 Hz) magnetic field IEC 61000-4-8	3 A/m	3 A/m	Power frequency magnetic fields should be at levels characteristic of a typical location in a typical commercial or hospital environment.
NOTE U_T is the a.c. mains voltage prior to application of the test level.			

Guidance and manufacturer’s declaration – electromagnetic immunity:

The Smartscope M5 is intended for use in the electromagnetic environment specified below. The customer or the user of the Smartscope M5 should assure that it is used in such an environment.

Immunity test	IEC 60601 test level	Compliance level	Electromagnetic environment – guidance
Conducted RF IEC 61000-4-6	3 Vrms 150 kHz to 80 MHz	3 Vrms	<p>Portable and mobile RF communications equipment should be used no closer to any part of the Smartscope M5, including cables, than the recommended separation distance calculated from the equation applicable to the frequency of the transmitter.</p> <p>Recommended separation distance</p> $d = 1,2 \sqrt{P}$
Radiated RF IEC 61000-4-3	3 V/m 80 MHz to 2,5 GHz	3 V/M	<p>$d = 1,2\sqrt{P}$ 80 MHz to 800 MHz $d = 2,3\sqrt{P}$ 800 MHz to 2,5 GHz,</p> <p>where P is the maximum output power rating of the transmitter in watts (W) according to the transmitter manufacturer and d is the recommended separation distance in metres (m).</p> <p>Field strengths from fixed RF transmitters, as determined by an electromagnetic site survey, a should be less than the compliance level in each frequency range.b.</p> <p>Interference may occur in the vicinity of equipment marked with the following symbol:</p> 

NOTE 1 At 80 MHz and 800 MHz, the higher frequency range applies.
 NOTE 2 These guidelines may not apply in all situations. Electromagnetic propagation is affected by absorption and reflection from structures, objects and people.

a Field strengths from fixed transmitters, such as base stations for radio (cellular/cordless) telephones and land mobile radios, amateur radio, AM and FM radio broadcast and TV broadcast cannot be predicted theoretically with accuracy. To assess the electromagnetic environment due to fixed RF transmitters, an electromagnetic site survey should be considered. If the measured field strength in the location in which the Smartscope M5 is used exceeds the applicable RF compliance level above, the Model 006 should be observed to verify normal operation. If abnormal performance is observed, additional measures may be necessary, such as re-orienting or relocating the Smartscope M5.
 b Over the frequency range 150 kHz to 80 MHz, field strengths should be less than 3 V/m.

Manufacturer’s declaration – electromagnetic emissions:

SMARTSCOPE M5 is intended for use in the electromagnetic environment specified below. The customer or the user of the Smartscope M5 should assure that it is used in such an environment.		
Emissions test	Compliance level	Electromagnetic environment – guidance
RF emissions CISPR 11	Group 1	M5 uses RF energy only for its internal function. Therefore, its RF emissions are very low and are not likely to cause any interference in nearby electronic equipment.
RF emissions CISPR 11	Class B	M5 is suitable for use in all establishments, including domestic establishments and those directly connected to the public low-voltage power supply network that supplies buildings used for domestic purposes.
Harmonic emissions IEC 61000-3-2	Not applicable	
Voltage fluctuations/ flicker emissions IEC 61000-3-3	Complies	

Recommended separation distances between portable and mobile RF communications equipment and Optomed Smartscope M5:

Optomed Smartscope M5 is intended for use in an electromagnetic environment in which radiated RF disturbances are controlled. The customer or the user of Optomed Smartscope M5 can help prevent electromagnetic interference by maintaining a minimum distance between portable and mobile RF communications equipment (transmitters) and Optomed Smartscope M5 as recommended below, according to the maximum output power of the communications equipment.			
Rated maximum output power of transmitter W	Separation distance according to frequency of transmitter m		
	150 kHz to 80 MHz $d = 1,2 \sqrt{P}$	150 kHz to 80 MHz $d = 1,2\sqrt{P}$	800 MHz to 2,5 GHz $d = 2,3\sqrt{P}$
0,01	0,12	0,12	0,23
0,1	0,38	0,38	0,73
1	1,2	1,2	2,3
10	3,8	3,8	7,3
100	12	12	23
<p>For transmitters rated at a maximum output power not listed above, the recommended separation distance d in metres (m) can be estimated using the equation applicable to the frequency of the transmitter, where P is the maximum output power rating of the transmitter in watts (W) according to the transmitter manufacturer.</p> <p>NOTE 1 At 80 MHz and 800 MHz, the separation distance for the higher frequency range applies. NOTE 2 These guidelines may not apply in all situations. Electromagnetic propagation is affected by absorption and reflection from structures, objects and people.</p>			

Appendix B - Replacing the battery

Battery pack is specially designed and manufactured for this device. Optomed and Optomed retailers provide suitable battery packs. Labels in the battery and label inside the battery cover display following information:

NiMH battery
4/HR-4U AAA
4.8V/1000 mAh

Procedure for replacing the battery is:



1. Open the battery compartment cover by pushing and tilting the snap through the hole next to the connector in the bottom of the device. A pen, screw driver or similar pointy small device can be used to assist in opening the cover.



2. Remove the battery compartment cover by lifting it up.



3. Remove old battery. Squeeze battery wires with fingers and pull the connector out from its socket.



4. Put the new battery in the same position and attach the connector to its socket.
5. Replace the battery compartment cover and secure it in place by snapping it firmly to place.

Appendix C - WIFI Installation Guide

- Information about WIFI functionality
- Installation
- Set up
- Problem solving

Information about WIFI functionality

Wi-Fi feature is implemented by using Eye-Fi card. More information about the card can be found in Eye-Fi internet pages:

<http://www.eyefi.com/products>

System requirements:

Smartscope with WIFI card

Computer running Windows 7 or 8 Pro with Wi-Fi capability, 10 MB of free disk space and a minimum 2GB of RAM

Previous versions of Eye-Fi desktop software must be removed before installing the Mobile Desktop Transfer

Installation

1. Install Eyefi Mobi Desktop Transfer for Windows from USB memory stick (provided by Optomed Oy).
2. Run setup_1.1_ENU.exe
 - Enclosed pop up window will open
3. Select "Next"

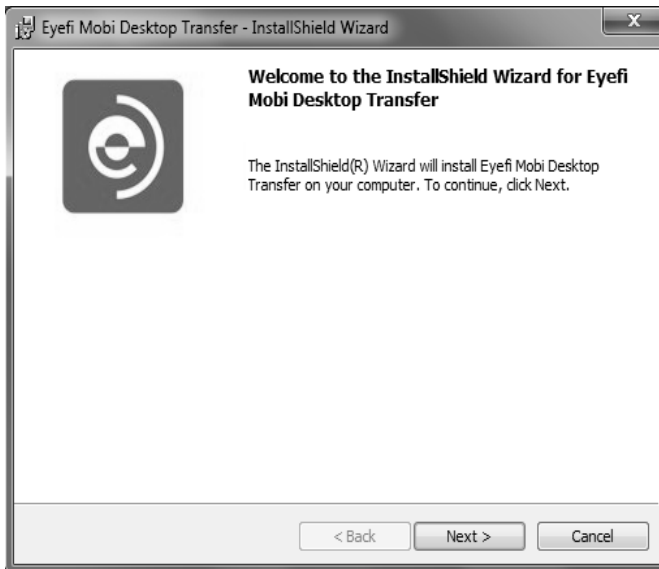

4. Accept license agreement
5. Select "Next"

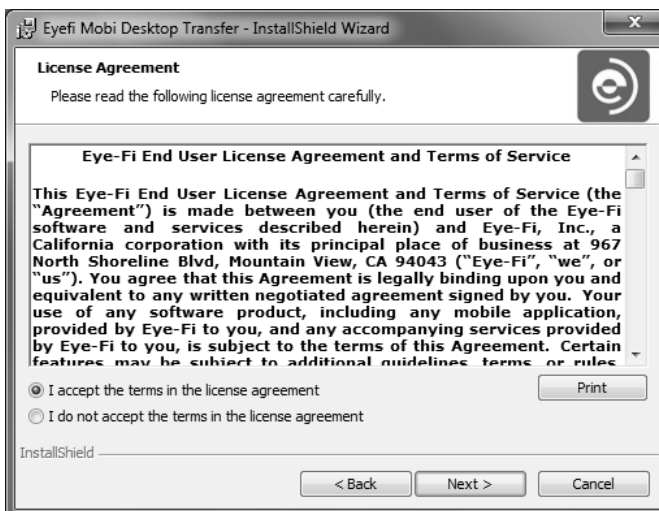

6. Select "Install"



7. Select "Finish"

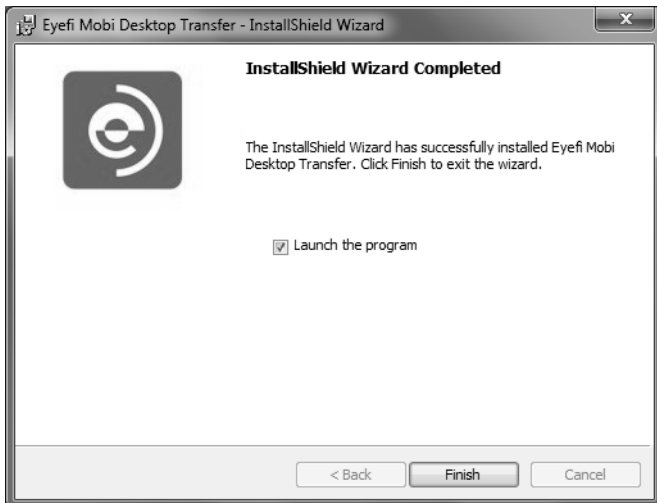

8. Your Windows Firewall may ask (depending on your computer setting) Allowance for Eye-Fi helper ➔ Select "Allow access"

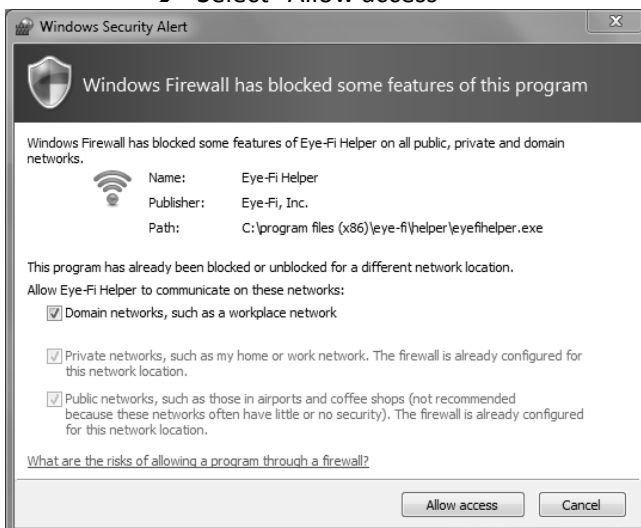

Set up

1. Enter 10-digit activation code
 - Activation code can be found under camera battery cover

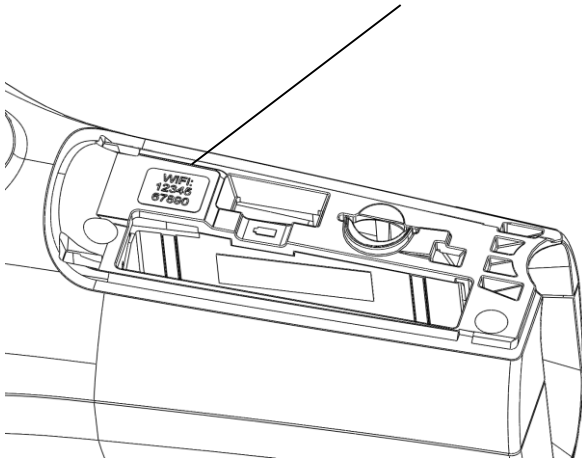

2. Type activation code
3. Select "Next"



4. Select folder where to transfer images and videos
 - It is recommended to use folder "C:\Optomedworkstation\wifi" with Optomed Workstation viewing software
 - If you are not using Optomed Workstation viewing software, you can use any folder in your computer
5. "Create subfolders" are selected by default. Please remove selection from check boxes at the right side
6. Select "Next"

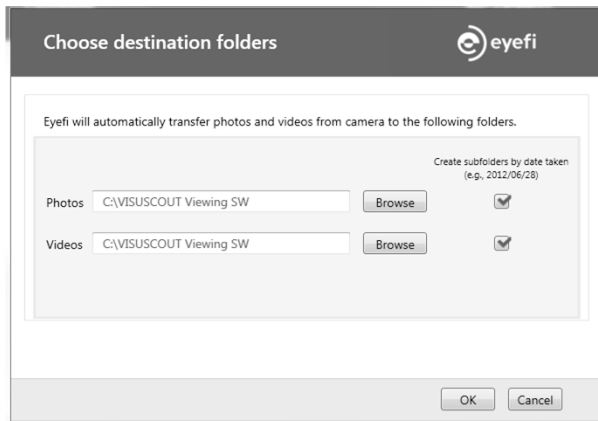

7. Power on your camera
8. Take some images and wait for the images to transfer

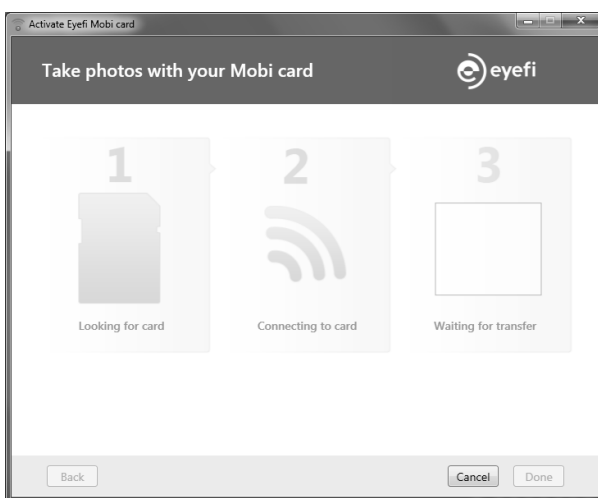

9. Select "Done"
10. Set up is completed and Wi-Fi transfer is enabled to your computer



Problem solving

A. Computer cannot connect to Smartscope

- Verify that your computer's Wi-Fi is enabled. Instructions can be found from your Operating system help
- Select "Back" and select "Next" again
- Take more images
- Wait for images to transfer

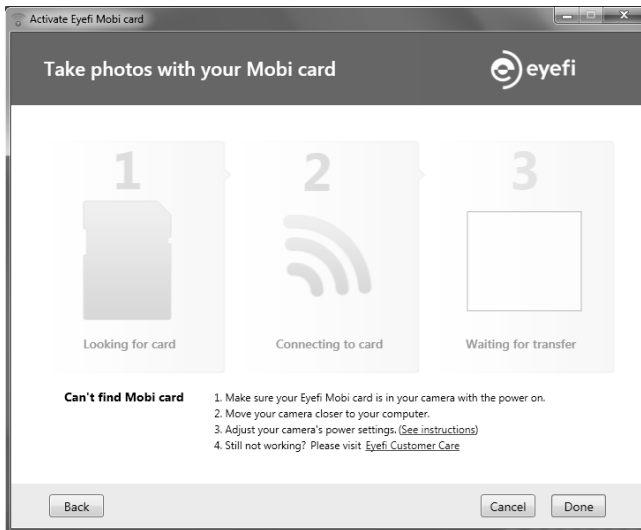

B. Computer is connected to camera, but images don't transfer

- Go to your computers Network and Sharing Center
- Verify that Network type is "Work" instead of "Public"
- Change Network type by clicking blue Public Network text