

Freescale Semiconductor, Inc.

M5307C3 USER'S MANUAL
REVISION 1.1

Freescale Semiconductor, Inc.

Matrix Design & Manufacturing, Inc.
2914 Montopolis Drive #290
Austin, TX 78741
Phone: (512) 385-9210
Fax: (512) 385-9224
<http://www.cadreiii.com>

**For More Information On This Product,
Go to: www.freescale.com**

Freescale Semiconductor, Inc.

COPYRIGHT

Copyright 1999 by Motorola SPS

All rights reserved. No part of this manual and the dBUG software provided in Flash ROM's/EPROM's may be reproduced, stored in a retrieval system, or transmitted in any form or by any means, electronic, mechanical, photocopying, recording, or otherwise. Use of the program or any part thereof, for any purpose other than single end user by the purchaser is prohibited.

DISCLAIMER

The information in this manual has been carefully examined and is believed to be entirely reliable. However, no responsibility is assumed for inaccuracies. Furthermore, Motorola reserves the right to make changes to any product(s) herein to improve reliability, function, or design. The M5307C3 board is not intended for use in life and/or property critical applications. Here, such applications are defined to be any situation in which any failure, malfunction, or unintended operation of the board could, directly or indirectly, threaten life, result in personal injury, or cause damage to property. Although every effort has been made to make the supplied software and its documentation as accurate and functional as possible, Motorola Inc. will not assume responsibility for any damages incurred or generated by this product. Motorola does not assume any liability arising out of the application or use of any product or circuit described herein, neither does it convey any license under its patent rights, if any, or the rights of others.

WARNING

THIS BOARD GENERATES, USES, AND CAN RADIATE RADIO FREQUENCY ENERGY AND, IF NOT INSTALLED PROPERLY, MAY CAUSE INTERFERENCE TO RADIO COMMUNICATIONS. AS TEMPORARILY PERMITTED BY REGULATION, IT HAS NOT BEEN TESTED FOR COMPLIANCE WITH THE LIMITS FOR CLASS A COMPUTING DEVICES PURSUANT TO SUBPART J OF PART 15 OF FCC RULES, WHICH ARE DESIGNED TO PROVIDE REASONABLE PROTECTION AGAINST SUCH

**For More Information On This Product,
Go to: www.freescale.com**

Freescale Semiconductor, Inc.

INTERFERENCE. OPERATION OF THIS PRODUCT IN A RESIDENTIAL AREA IS LIKELY TO CAUSE INTERFERENCE, IN WHICH CASE THE USER, AT HIS/HER OWN EXPENSE, WILL BE REQUIRED TO CORRECT THE INTERFERENCE.

LIMITED WARRANTY

Matrix Design warrants this product against defects in material and workmanship for a period of sixty (60) days from the original date of purchase. This warranty extends to the original customer only and is in lieu of all other warrants, including implied warranties of merchantability and fitness. In no event will the seller be liable for any incidental or consequential damages. During the warranty period, Matrix Design will replace, at no charge, components that ~~provided~~ the product is returned (properly packed and shipped prepaid) to Matrix Design at address below. Dated proof of purchase (such as a copy of the invoice) must be enclosed with the shipment. We will return the shipment prepaid via UPS.

This warranty does not apply if, in the opinion of Matrix Design, the product has been damaged by accident, misuse, neglect, misapplication, or as a result of service or modification (other than specified in the manual) by others.

Please send the board and cables with a complete description of the problem to:

Matrix Design & Manufacturing, Inc.
2914 Montopolis Drive #290
Austin, TX 78741
Phone: (512) 385-9210
Fax: (512) 385-9224
<http://www.cadreiii.com>

Motorola is a registered trademark of Motorola Inc.

Freescale Semiconductor, Inc.

IBM PC and IBM AT are registered trademark of IBM Corp.

I² C-Bus is a proprietary Philips interface bus.

All other trademark names mentioned in this manual are the registered trade mark of respective owners.

Freescale Semiconductor, Inc.

TABLE OF CONTENTS

CHAPTER 1 1-1

- 1.1 INTRODUCTION 1-1
- 1.2 GENERAL HARDWARE DESCRIPTION 1-1
- 1.3 SYSTEM MEMORY 1-4
- 1.4 SERIAL COMMUNICATION CHANNELS 1-4
- 1.5 PARALLEL I/O PORTS 1-4
- 1.6 PROGRAMMABLE TIMER/COUNTER 1-5
- 1.7 ON BOARD ETHERNET 1-6
- 1.8 SYSTEM CONFIGURATION 1-6
- 1.9 INSTALLATION AND SETUP 1-6
 - 1.9.1. Unpacking 1-6
 - 1.9.2. Preparing the Board for Use 1-7
 - 1.9.3. Providing Power to the Board 1-7
 - 1.9.4. Selecting Terminal Baud Rate 1-8
 - 1.9.5. The Terminal Character Format 1-8
 - 1.9.6. Connecting the Terminal 1-8
 - 1.9.7. Using a Personal Computer as a Terminal 1-8
- 1.10 SYSTEM POWER-UP AND INITIAL OPERATION 1-13
- 1.11 M5307C3 Jumper Setup 1-13
 - 1.11.1. Jumper JP1- Flash Upper Half/Lower Half Boot 1-14
 - 1.11.2. Jumper JP2 - This jumper selects between /CS0 to Flash or a header 1-15
- 1.12 USING THE BDM 1-15

CHAPTER 2 2-1

- 2.1 WHAT IS dBUG? 2-1
- 2.2 OPERATIONAL PROCEDURE 2-3
 - 2.2.1. System Power-up 2-3
 - 2.2.2. System Initialization 2-5
 - 2.2.3. System Operation 2-6
- 2.3 TERMINAL CONTROL CHARACTERS 2-7
- 2.4 dBUG COMMAND SET 2-8
 - 2.4.1. AS - Assemble AS 2-11
 - 2.4.2. BC - Compare Blocks of Memory BC 2-13
 - 2.4.3. BF - Block of Memory Fill BF 2-14
 - 2.4.4. BM - Block Move BM 2-15
 - 2.4.5. BR - Breakpoint BR 2-16
 - 2.4.6. BS - Block Search BS 2-18
 - 2.4.7. DATA - Data Conversion DATA 2-20
 - 2.4.8. DI - Disassemble DI 2-21
 - 2.4.9. DL - Download Serial DL 2-22
 - 2.4.10. DN - Download Network DN 2-23
 - 2.4.11. Go - Execute GO 2-25

2.4.12.	GT - Execute Till a Temporary Breakpoint	GT 2-26
2.4.13.	HELP - Help	HE 2-27
2.4.14.	IRD - Internal Registers Display	IRD 2-28
2.4.15.	IRM - Internal Registers MODIFY	IRM 2-29
2.4.16.	MD - Memory Display	MD 2-30
2.4.17.	MM - Memory Modify	MM 2-31
2.4.18.	RD - Register Display	RD 2-32
2.4.19.	RM - Register Modify	RM 2-33
2.4.20.	RESET - Reset the board and dBUG	RESET 2-34
2.4.21.	SET - Set Configuration	SET 2-35
2.4.22.	SHOW - Show Configuration	SHOW 2-37
2.4.23.	STEP - Step Over	ST 2-38
2.4.24.	SYMBOL - Symbol Name Management	SYMBOL 2-39
2.4.25.	TRACE - Trace Into	TR 2-40
2.4.26.	UPDEBUG - Update the dBUG Image	UPDEBUG 2-41
2.4.27.	UPUSER - Update User Code In Flash	UPUSER 2-42

2.5 *TRAP #15 Functions 2-44*

2.5.1.	OUT_CHAR	2-44
2.5.2.	IN_CHAR	2-45
2.5.3.	CHAR_PRESENT	2-45
2.5.4.	EXIT_TO_dBUG	2-46

CHAPTER 3 **48**

3.1 *THE PROCESSOR AND SUPPORT LOGIC 48*

3.1.1.	The Processor	48
3.1.2.	The Reset Logic	49
3.1.3.	The -HIZ Signal	49
3.1.4.	The Clock Circuitry	49
3.1.5.	Watchdog Timer	49
3.1.6.	Interrupt Sources	50
3.1.7.	Internal SRAM	51
3.1.8.	The MCF5307 Registers and Memory Map	51
3.1.9.	Reset Vector Mapping	53
3.1.10.	-TA Generation	53
3.1.11.	Wait State Generator	54

3.2 *THE SDRAM DIMM 54*

3.3 *FLASH ROM 55*

3.3.1.	JP1 Jumper and User's Program	55
--------	-------------------------------	----

3.4 *THE SERIAL COMMUNICATION CHANNELS 56*

3.4.1.	The MCF5307 2 UARTs	56
3.4.2.	Motorola Bus (M-Bus) Module	56

3.5 *THE PARALLEL I/O Port 56*

3.6 *ON BOARD ETHERNET LOGIC 57*

3.7 *THE CONNECTORS AND THE EXPANSION BUS 59*

3.7.1.	The Terminal Connector P4	59
3.7.2.	The Auxiliary Serial Communication Connector P3	60
3.7.3.	Logical Analyzer connectors LA1-5 and Processor Expansion Bus J3, J4, & J5	61
3.7.4.	The Debug Connector J1	70

Freescale Semiconductor, Inc.

APPENDIX A (Configuring dBUG for Network Downloads) **1**

A.1 *Required Network Parameters 1*

A.2 *Configuring dBUG Network Parameters 1*

A.3 *Troubleshooting Network Problems 3*

APPENDIX B (ColdFire to ISA, IRQ7 and Reset Logic Abel code) **1**

APPENDIX C (Schematics) **2**

APPENDIX D SDRAM MUX PAL EQUATION **1**

APPENDIX E SDRAM MUX WHITE PAPER **1**

APPENDIX F EVALUATION BOARD BOM **1**

MCF5307EVM_BOM 1

TABLES

Table 1 - JP1, Upper/Lower Half BOOT	1-15
Table 2 - JP2, /CS0 select	1-15
Table 3 - dBUG Commands	2-9
Table 4 - The M5307C3 memory map	53
Table 5 - The P4 (Terminal) Connector pin assignment	60
Table 7 - The P3 Connector pin assignment	61
Table 8 - The J3 Connector pin assignment	61
Table 9 - The J4 Connector pin assignment	63

Figures

Figure 1 Block Diagram of the board	1-3
Figure 2 Pin assignment for P4 (Terminal) connector	1-9
Figure 3 Jumper Table and Locations	1-10
Figure 4 System Configuration	1-11
Figure 5 Flow Diagram of dBUG Operational Mode.	2-4

CHAPTER 1

INTRODUCTION TO THE M5307C3 BOARD

1.1 INTRODUCTION

The M5307C3 is a versatile single board computer based on MCF5307 ColdFire® Processor. It may be used as a powerful microprocessor based controller in a variety of applications. With the addition of a terminal, it serves as a complete microcomputer for development/evaluation, training and educational use. The user must only connect an RS-232 compatible terminal (or a personal computer with terminal emulation software) and a power supply to have a fully functional system.

Provisions have been made to connect this board to additional user supplied boards, via the Microprocessor Expansion Bus connectors, to expand memory and I/O capabilities. Additional boards may require bus buffers to minimize additional bus loading.

Furthermore, provisions have been made in the PC-board to permit configuration of the board in a way, which best suits an application. Options available are: up to 512M SDRAM, 512K SRAM, Timer, I/O, Ethernet, and 1M of Flash. In addition, all of the signals are easily accessible to any logical analyzer with mictor probes to assist in debugging. Most of the processor's signals are also available via berg connectors J3, J4 and J5 for expansion purposes.

1.2 GENERAL HARDWARE DESCRIPTION

The M5307C3 board provides the RAM, Flash ROM, on board NE2000 compatible Ethernet interface (10M bit/sec), RS232, and all the built-in I/O functions of the MCF5307 for learning and evaluating the attributes of the MCF5307. The MCF5307 is a member of the ColdFire® family of processors. It is a 32-bit processor with 32 bits of addressing and 32 lines of data. The processor has eight 32-bit data registers, eight 32-bit address registers, a 32-bit program counter, and a 16-bit status register.

Freescale Semiconductor, Inc.

The MCF5307 has a System Integration Module referred to as the SIM. The module incorporates many of the functions needed for system design. These include programmable chip-select logic, System Protection logic, General purpose I/O, and Interrupt controller logic. The chip-select logic can select up to eight memory banks and peripherals in addition to two banks of DRAM's. The chip-select logic also allows programmable number of wait-states and the use of slower memory (refer to MCF5307 User's Manual by Motorola for detailed information about the SIM.) The M5307C3 only uses three of the chip selects to access the Flash ROM's (CS0), SRAM (CS2); which is not populated on board, may be added by the user) and the Ethernet (CS3). The DRAM controller is used to control one DIMM module (up to 512M of SDRAM, both -RAS lines and all four -CAS lines are used. Other functions of the SIM are available to the user.

A block diagram of the board is shown in Figure 1.

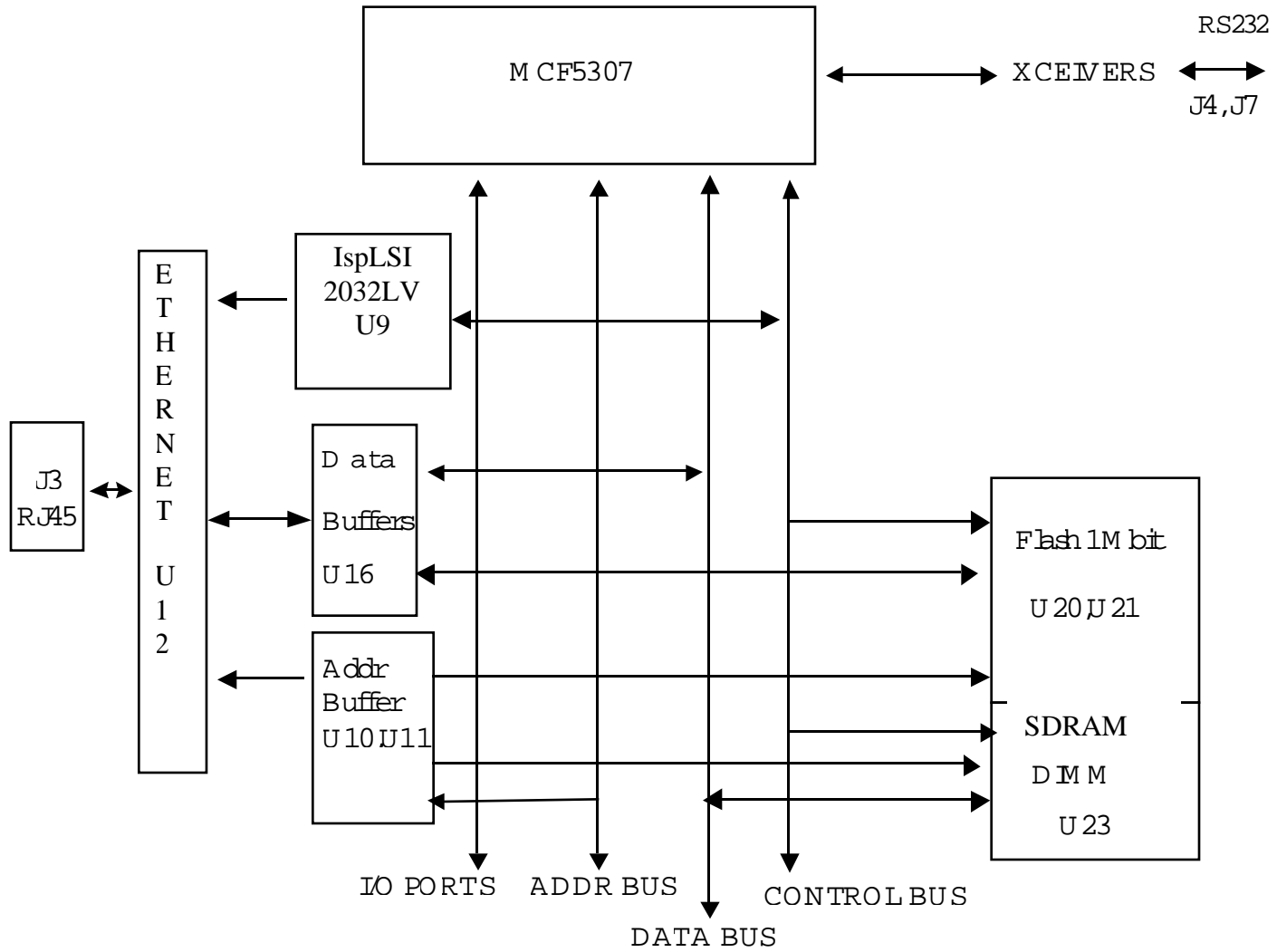

M ictor and Expansion Connectors

Figure 1 Block Diagram of the board

1.3 SYSTEM MEMORY

There are two on board Flash ROM's (U20, U21), U20 is the most significant byte and the U21 is the least significant byte. The M5307C3 comes with two 29LV004 Flash ROM's programmed with a debugger/monitor firmware. Both AM29LV004DT Flash are 4Mbits each giving a total of 1Mbyte of Flash memory

There is one 168-pin DIMM socket for SDRAM. System ships with 1M8 Bank x 16-Bits SDRAM totaling 16M of volatile memory. Various SDRAM configurations are supported.

The MCF5307 has 4K bytes organized as 1024x32 bits of internal SRAM.

The internal cache of the MCF5307 is a non-blocking, 8kbyte, 4-way set-associative, unified (instruction and data) cache with a 16-byte line size. The ROM Monitor currently does not utilize the cache, but programs downloaded with the ROM Monitor can use the cache.

The M5307C3 evaluation board has a foot print for 512 K SRAM but is unpopulated.

1.4 SERIAL COMMUNICATION CHANNELS

The MCF5307 has 2 built-in UART's (UART0 and UART1) with independent baud rate generators. The signals of channel one are passed through external Driver/Receiver to make the channel compatible with RS-232. UART0 is used by the debugger for the user to access with a terminal. In addition, the signals of both channels are available to the micro connectors LA1 and LA3 to be viewed by a logic analyzer. UART0 channel is the "TERMINAL" channel used by the debugger for communication with external terminal/PC. The "TERMINAL" baud rate is set at 19200

1.5 PARALLEL I/O PORTS

MCF5307 offers one 16-bit general-purpose parallel I/O port. Each pin can be individually programmed as input or output. The parallel port bits PP(7:0) is multiplexed with TT(1:0), TM(2:0), DREQ(1:0), and XTIP. The second set of parallel port bits PP(15:8) is multiplexed with address bus bits A(31:24). Both bytes of the parallel port are controlled by the Pin Assignment Register (PAR).

Freescale Semiconductor, Inc.

The pins are programmable on a pin by pin basis. The setting of the multiplex pins are determined by the configuration byte during reset. After reset, all pins are configured as general-purpose parallel I/O. These pins are connected to J3, LA2 and LA3.

1.6 PROGRAMMABLE TIMER/COUNTER

The MCF5307 has two built-in general purpose timer/counters. These timers are available to the user. The signals for the timer are available on the LA4 to be viewed by a logic analyzer. These pins are connected to J3 as well.

1.7 ON BOARD ETHERNET

The M5307C3 has an on board Ethernet (NE2000 compatible) operating at 10M bits/sec. The on board ROM MONITOR is programmed to allow a user to download files from a network to memory in different formats. The current formats supported are S-Record, COFF, ELF, or Image.

1.8 SYSTEM CONFIGURATION

The M5307C3 board requires only the following items for minimum system configuration (Figure 3):

1. The M5307C3 board (provided).
2. Power supply, 6.5V to 9V with minimum of 1.5 Amp.
3. RS-232C compatible terminal or a PC with terminal emulation software.
4. Communication cable (provided).

Refer to next sections for initial setup.

1.9 INSTALLATION AND SETUP

The following sections describe all the steps needed to prepare the board for operation. Please read the following sections carefully before using the board. When you are preparing the board for the first time, be sure to check that all jumpers are in the default locations. The standard configuration does not require any modifications. After the board is functional in its standard configuration, you may use the Ethernet by following the instructions provided in Appendix A.

1.9.1. Unpacking

Unpack the computer board from its shipping box. Save the box for storing or reshipping. Refer to the following list and verify that all the items are present. You should have received:

1. M5307C3 Single Board Computer

Freescale Semiconductor, Inc.

2. M5307C3 User's Manual, this documentation
3. One RS-232 communication cable
4. Debug wiggler cable
5. Programmers Reference Manual
6. A selection of Third Party Developer Tools and Literature

WARNING

AVOID TOUCHING THE MOS DEVICES. STATIC DISCHARGE CAN AND WILL DAMAGE THESE DEVICES.

Once you verified that all the items are present, remove the board from its protective jacket. Check the board for any visible damage. Ensure that there are no broken, damaged, or missing parts. If you have not received all the items listed above or they are damaged, please contact Cadre III immediately in order to correct the problem.

1.9.2. Preparing the Board for Use

The board as shipped is ready to be connected to a terminal and the power supply without any need for modification. However, follow the steps below to insure proper operation from the first time you apply the power. Figure 3 Jumper Table and Locations shows the placement of the jumpers and the connectors, which you need to refer to in the following sections. The steps to be taken are:

- a. Connecting the power supply.
- b. Connecting the terminal.

1.9.3. Providing Power to the Board

The board accepts two means of power supply connections. Connector P2 is a 2.1mm power jack and P1 lever actuated connector. The board accepts 6.5V to 9V DC (regulated or unregulated) at 1.5 Amp via either one of the connector

<u>Contact NO.</u>	<u>Voltage</u>
1	+6.5-9V
2	Ground

1-

**For More Information On This Product,
Go to: www.freescale.com**

1.9.4. *Selecting Terminal Baud Rate*

The serial channel of MCF5307 which is used for serial communication has a built-in timer used by the ROM MONITOR to generate the baud rate used to communicate with a terminal.. It can be programmed to a number of baud rates. After the power-up or a manual RESET, the ROM Monitor firmware configures the channel for 19200 baud. After the ROM Monitor is running, you may issue the SET command to choose any baud rate supported by the ROM Monitor. Refer to Chapter 2 for the discussion of this command.

1.9.5. *The Terminal Character Format*

The character format of the communication channel is fixed at the power-up or RESET. The character format is 8 bits per character, no parity, and one stop bit. You need to insure that your terminal or PC is set to this format.

1.9.6. *Connecting the Terminal*

The board is now ready to be connected to a terminal. Use the RS-232 serial cable to connect the PC to the M5307C3. The cable has a 9-pin female D-sub connector at one end and a 9-pin male D-sub connector at the other end. Connect the 9-pin male connector to P4 connector on M5307C3. Connect the 9-pin female connector to one of the available serial communication channels normally referred to as COM1 (COM2, etc.) on the IBM PC's or compatible. Depending on the kind of serial connector on the back of your PC, the connector on your PC may be a male 25-pin or 9-pin. You may need obtain a 9-pin-to-25-pin adapter to make the connection. If you need to build an adapter, refer to Figure 2 which shows the pin assignment for the 9-pin connector on the board.

1.9.7. *Using a Personal Computer as a Terminal*

You may use your personal computer as a terminal provided you also have a terminal emulation software such as PROCOMM, KERMIT, QMODEM, Windows 95 Hyper Terminal or similar packages. Then connect as described in 1.9.6 Connecting the Terminal.

Freescale Semiconductor, Inc.

Once the connection to the PC is made, you are ready to power-up the PC and run the terminal emulation software. When you are in the terminal mode, you need to select the baud rate and the character format for the channel. Most terminal emulation software packages provide a command known as "Alt-p" (press the p key while pressing the Alt key) to choose the baud rate and character format. Make sure you select 8 bits, no parity, one stop bit, see section The Terminal Character Format. Then, select the baud rate as 19200. Now you are ready to apply power to the board.

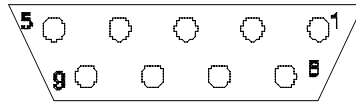

Figure 2 Pin assignment for P4 (Terminal) connector.

1. Data Carrier Detect, Output (shorted to pins 4 and 6).
2. Receive Data, Output from board (receive refers to terminal side)
3. Transmit Data, Input to board (transmit refers to terminal side).
4. Data Terminal Ready, input (shorted to pin 1 and 6).
5. Signal Ground.
6. Data Set Ready, Output (shorted to pins 1 and 4).
7. Request to Send, input.
8. Clear to send, output.
9. Not connected.

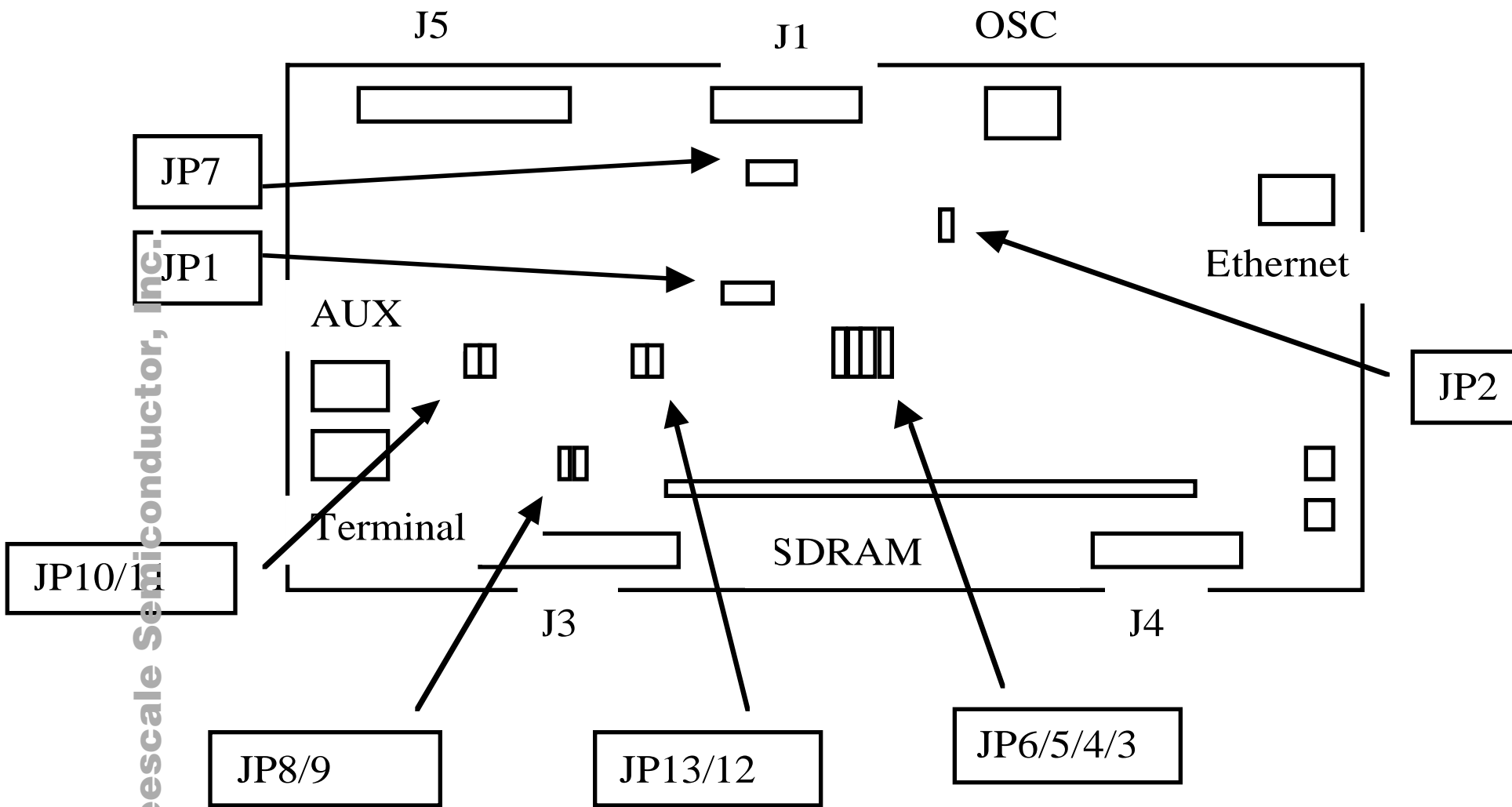

Figure 3 Jumper Table and Locations

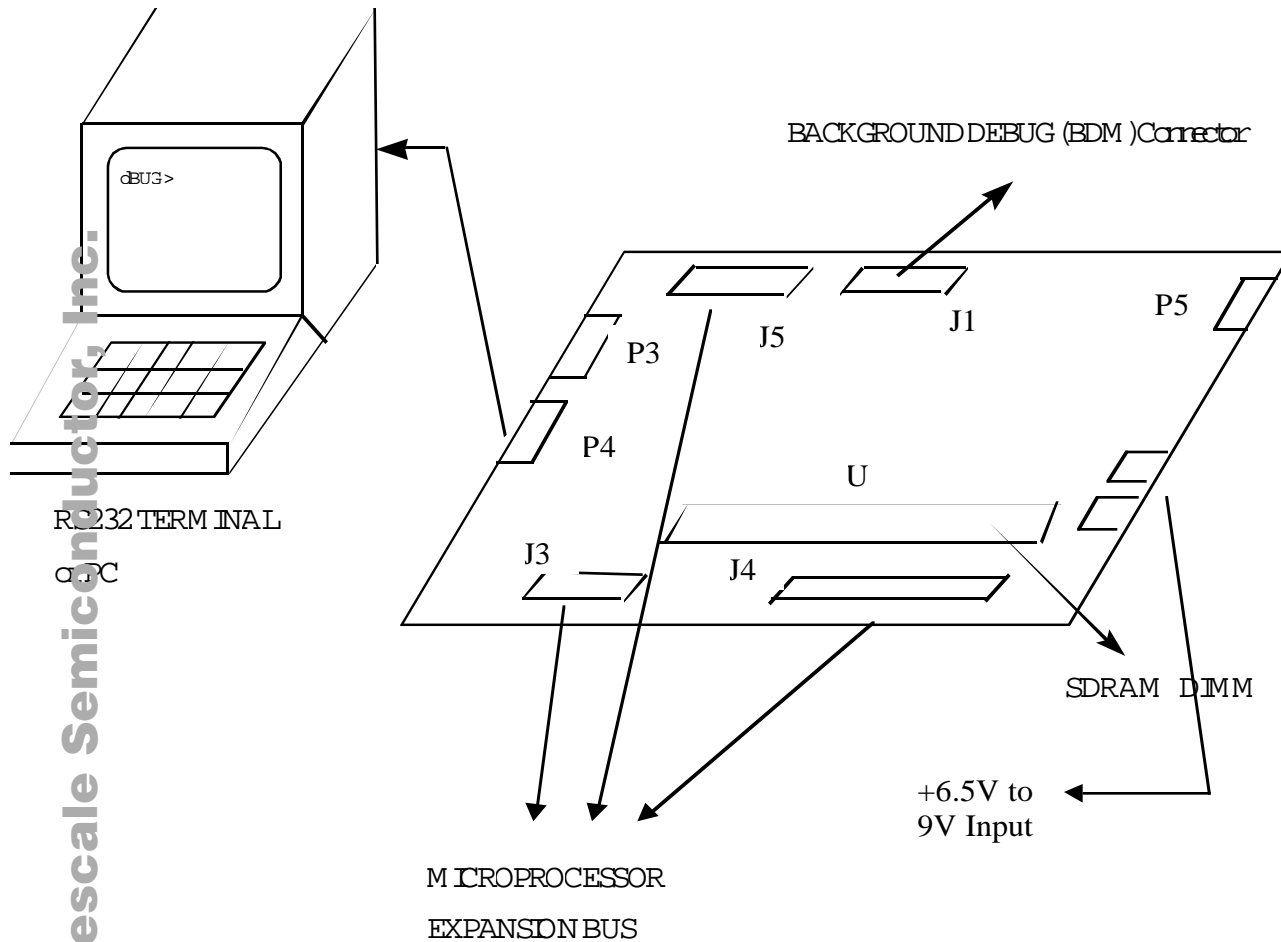

Figure 4 System Configuration

1.10 SYSTEM POWER-UP AND INITIAL OPERATION

Now that you have connected all the cables, you may apply power to the board. After power is applied, the dBUG initializes the board then display power-up message on the terminal, which includes the amount of the memory present.

```
Hard Reset
DRAM Size: 8M
NE2000: 0x300
```

```
Copyright 1997-1998 Motorola, Inc. All Rights Reserved.
ColdFire® MCF5307 EVS Debugger Vx.x.x (xxx 199x xx:xx:xx:)
Enter 'help' for help.
```

```
dBUG>
```

The board is now ready for operation under the control of the debugger as described in Chapters 2. If you do not get the above response, perform the following checks:

1. Make sure that the power supply is properly set and connected to the board.
2. Check that the terminal and board are set for the same character format and baud.
3. Press the red RESET button to insure that the board has been initialized properly.

If you still are not receiving the proper response, your board may have been damaged in shipping. Contact Cadre III for further instructions.

1.11 M5307C3 Jumper Setup

Freescale Semiconductor, Inc.

The jumpers on the board are discussed in Chapter 3. However, a brief discussion of the jumper settings is as follows:

1.11.1. Jumper JP1- Flash Upper Half/Lower Half Boot

This jumper allows the MCF5307 to boot from the lower or upper half of the flash. The default is the lower half.

Table 1 - JP1, Upper/Lower Half BOOT

JP1	Function
1 and 2	Lower (default)
2 and 3	Upper

1.11.2. Jumper JP2 - This jumper selects between /CS0 to Flash or a header

Table 2 - JP2, /CS0 select

JP2	Function
1 and 2	Flash (default)
2 and 3	header

1.12 USING THE BDM

The MCF5307 has a built in debug mechanism referred to as BDM. The M5307C3 has the necessary connector, J1, to facilitate this connection.

In order to use the BDM, simply connect the 26-pin IDC header at the end of the BDM wiggler cable provided Motorola from P&E Microcomputer Systems to the J1 connector. No special setting is needed. Refer to the ColdFire® User's Manual BDM Section for additional instructions.

USING THE MONITOR/DEBUG FIRMWARE

The M5307C3 single board computer has a resident firmware package that provides a self-contained programming and operating environment. The firmware, named dBUG, provides the user with monitor/debug, disassembly, program download, and I/O control functions. This Chapter is a how-to-use description of the dBUG package, including the user interface and command structure.

2.1 WHAT IS dBUG?

dBUG is a resident firmware package for the ColdFire® family single board computers. The firmware (stored in two 512Kx8 Flash ROM devices) provides a self-contained programming and operating environment. dBUG interacts with the user through pre-defined commands that are entered via the terminal.

The user interface to dBUG is the command line. A number of features have been implemented to achieve an easy and intuitive command line interface.

dBUG assumes that an 80x24 character dumb-terminal is utilized to connect to the debugger. For serial communications, dBUG requires eight data bits, no parity, and one stop bit, 8N1. The baud rate is 19200 and can be changed after the power-up.

The command line prompt is "dBUG> ". Any dBUG command may be entered from this prompt. dBUG does not allow command lines to exceed 80 characters. Wherever possible, dBUG displays data in 80 columns. dBUG echoes each character as it is typed, eliminating the need for any "local echo" on the terminal side.

In general, dBUG is not case sensitive. Commands may be entered either in upper or lower case, depending upon the user's equipment and preference. Only symbol names require that the exact case be used.

Most commands can be recognized by using an abbreviated name. For instance, entering "h" is the same as entering "help". Thus, it is not necessary to type the entire command name.

Freescale Semiconductor, Inc.

The commands DI, GO, MD, STEP and TRACE are used repeatedly when debugging. dBUG recognizes this and allows for repeated execution of these commands with minimal typing. After a command is entered, simply press <RETURN> or <ENTER> to invoke the command again. The command is executed as if no command line parameters were provided.

An additional function called the "TRAP handler" allows the user program to utilize various routines within dBUG. The TRAP 15 handler is discussed at the end of this chapter.

The operational mode of dBUG is demonstrated in Figure 5. After the system initialization, the board waits for a command-line input from the user terminal. When a proper command is entered, the operation continues in one of the two basic modes. If the command causes execution of the user program, the dBUG firmware may or may not be re-entered, depending on the discretion of the user. For the alternate case, the command will be executed under control of the dBUG firmware, and after command completion, the system returns to command entry mode.

During command execution, additional user input may be required depending on the command function.

For commands that accept an optional <width> to modify the memory access size, the valid values are:

- .B 8-bit (byte) access
- .W 16-bit (word) access
- .L 32-bit (long) access

When no <width> option is provided, the default width is .W, 16-bit.

The core ColdFire® register set is maintained by dBUG. These are listed below

- A0-A7
- D0-D7
- PC
- SR

All control registers on ColdFire® are not readable by the supervisor-programming model, and thus not accessible via dBUG. User code may change these registers, but caution must be exercised as changes may render dBUG useless.

A reference to "SP" actually refers to "A7".

2.2 OPERATIONAL PROCEDURE

System power-up and initialization are described in detail in Chapter 1. This information is repeated here for convenience and to prevent possible damage.

2.2.1. *System Power-up*

- a. Be sure the power supply is connected properly prior to power-up.
- b. Make sure the terminal is connected to TERMINAL (P4) connector.
- c. Turn power on to the board.

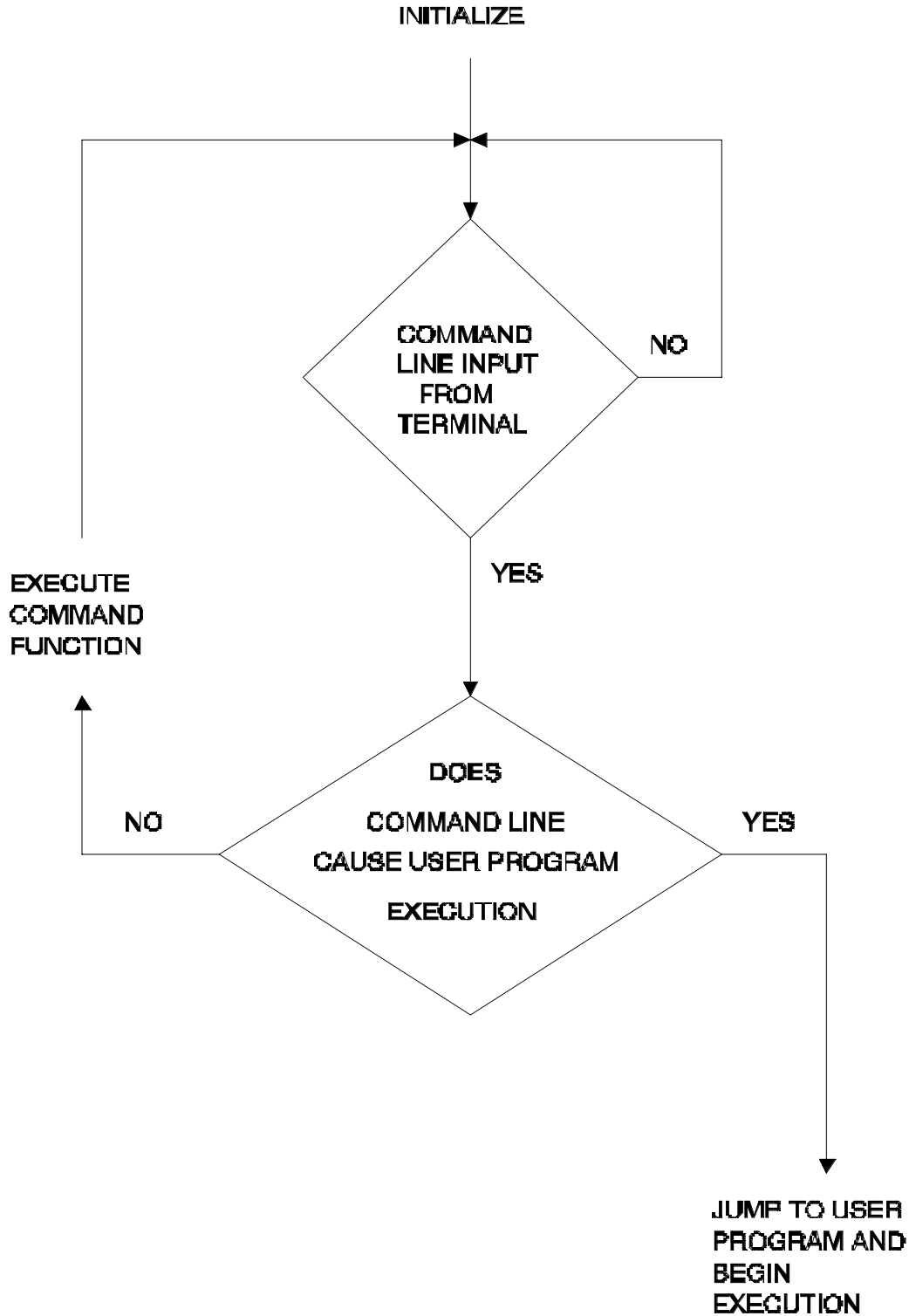

Figure 5 Flow Diagram of dBUG Operational Mode.

2.2.2. System Initialization

The act of powering up the board will initialize the system. The processor is reset and dBUG is invoked.

dBUG performs the following configurations of internal resources during the initialization. The instruction cache is invalidated and disabled. The Vector Base Register, VBR, points to the Flash. However, a copy of the exception table is made at address \$00000000 in SDRAM. To take over an exception vector, the user places the address of the exception handler in the appropriate vector in the vector table located at 0x00000000, and then points the VBR to 0x00000000.

The Software Watchdog Timer is disabled, Bus Monitor enabled, and internal timers are placed in stop condition. Interrupt controller registers initialized with unique interrupt level/priority pairs.

After initialization, the terminal will display:

Hard Reset

DRAM Size: 8M

NE2000: 0x300

Copyright 1997-1998 Motorola, Inc. All Rights Reserved.

ColdFire® MCF5307 EVS Debugger Vx.x.x (xxx 199x xx:xx:xx:)

Enter 'help' for help.

dBUG>

If you did not get this response check the setup. Refer to Section 1.10 SYSTEM POWER-UP AND INITIAL OPERATION. Note, the date 'xxx 199x xx:xx:xx' may vary in different revisions.

Other means can be used to re-initialize the M5307C3 Computer Board firmware. These means are discussed in the following paragraphs.

2.2.2.1. Hard RESET Button.

Hard RESET is the red button located in the lower right side of the board. Depressing this button causes all processes to terminate, resets the MCF5307 processor and board logic and restarts the dBUG firmware. Pressing the RESET button would be the appropriate action if all else fails.

2.2.2.2. ABORT Button.

ABORT is the black button located next to RESET button on the right side of the board. The abort function causes an interrupt of the present processing (a level 7 interrupt on MCF5307) and gives control to the dBUG firmware. This action differs from RESET in that no processor registers or memory contents are changed, the processor and peripherals are not reset, and dBUG is not restarted. Also, in response to depressing the ABORT button, the contents of the MCF5307 core internal registers are displayed.

The abort function is most appropriate when software is being debugged. The user can interrupt the processor without destroying the present state of the system. This is accomplished by forcing a non-maskable interrupt which calls a ROM monitor routine to preserve the current state of the registers to shadow registers in the monitor for display to the user. The user will be returned to the ROM monitor prompt after exception handling.

2.2.2.3. Software Reset Command.

dBUG does have a command that causes the dBUG to restart as if a hardware reset was invoked. The command is "RESET".

2.2.2.4. USER Program.

The user can return control of the system to the firmware by recalling dBUG his/her program. Instructions can be inserted into the user program to call dBUG via the TRAP 15 handler.

2.2.3. System Operation

After system initialization, the terminal will display:

Hard Reset

DRAM Size: 8M

NE2000: 0x300

Copyright 1997-1998 Motorola, Inc. All Rights Reserved.

ColdFire® MCF5307 EVS Debugger Vx.x.x (xxx 199x xx:xx:xx:)

Enter 'help' for help.

dBUG>

and waits for a command.

The user can call any of the commands supported by the firmware. A standard input routine controls the system while the user types a line of input. Command processing begins only after the line has been entered and followed by a carriage-return.

NOTES

1. The user memory is located at addresses \$00020000-\$xxxxxxx, \$xxxxxxx is the maximum SDRAM address of the memory installed in the board. When first learning the system, the user should limit his/her activities to this area of the memory map. Address range \$00000000-\$0001FFFF is used by dBUG.
2. If a command causes the system to access an unused address (i.e., no memory or peripheral device ~~are~~ mapped at that address), a bus trap error may occur. This results in the terminal printing out a trap error message and the contents of all the MCF5307 core registers. Control is returned to the dBUG monitor.

2.3 TERMINAL CONTROL CHARACTERS

The command line editor remembers the last five commands, in a history buffer, which were issued. They can be recalled and then executed using control keys.

Several keys are used as a command line edit and control functions. It is best to be familiar with these functions before exercising the system. These functions include:

- a. RETURN (carriage-return) - will enter the command line and causes processing to begin.
- b. Delete(Backspace) key or CTRL-H - will delete the last character entered on the terminal.
- c. CTRL-D - Go down in the command history buffer you may modify then press enter key.
- d. CTRL-U - Go up in the command history buffer, you may modify then press enter key.

Freescale Semiconductor, Inc.

- e. CTRL-R Recall and execute the last command entered, does not need the enter key to be pressed.

For characters requiring the control key (CTRL) the CTRL should be pushed and held down and then the other key (H) should be pressed.

2.4 dBUG COMMAND SET

Table 3 lists the dBUG commands. Each of the individual commands is described in the following pages.

Freescale Semiconductor, Inc.

Table 3 - dBUG Commands

COMMAND AND MNEMONIC	DESCRIPTION	SYNTAX	PAGE
AS	ASSEMBLE	AS <addr> <instruction>	2-11
BC	BLOCK COMPARE	BC FIRST SECOND LENGTH	2-14
BF	BLOCK FILL	BF<WIDTH> BEGIN END DATA	2-14
BM	BLOCK MOVE	BM BEGIN END DEST	2-15
BS	BLOCK SEARCH	BS <WIDTH> BEGIN END DATA	2-18
BR	BREAKPOINT	BR ADDR <-R> <-C COUNT> <-T TRIGGER>	2-16
DATA	DATA CONVERT	DATA VALUE	2-20
DI	DISASSEMBLE	DI <ADDR>	2-21
DL	DOWNLOAD SERIAL	DL <OFFSET>	2-22
DN	DOWNLOAD NETWORK	DN <-C> <-E> <-S> <-I> <-O OFFSET> <FILENAME>	2-23
GO	EXECUTE	GO <ADDR>	2-25
GT	Go TILL BREAKPOINT	GT <ADDR>	2-26
HELP	HELP	HELP <COMMAND>	2-27
IRD	INTERNAL REGISTER DISPLAY	IRD <MODULE.REGISTER>	2-28
IRM	INTERNAL REGISTER MODIFY	IRM <MODULE.REGISTER> <DATA>	2-29
MD	MEMORY DISPLAY	MD <WIDTH> <BEGIN> <END>	2-30

Freescale Semiconductor, Inc.

MM	MEMORY MODIFY	MM <WIDTH> ADDR <DATA>	2- 31
RD	REGISTER DISPLAY	RD <REG>	2- 32
RM	REGISTER MODIFY	RM REG DATA	2- 33
RESET	RESET	RESET	2- 34
SET	SET CONFIGURATIONS	SET OPTION <VALUE>	2- 35
SHOW	SHOW CONFIGURATIONS	SHOW OPTION	2- 37
STEP	STEP (OVER)	STEP	2- 38
SYMBOL	SYMBOL MANAGEMENT	SYMBOL <SYMB> <-A SYMB VALUE> <-R SYMB> <-C L S>	2- 39
TRACE	TRACE (INTO)	TRACE <NUM>	2- 40
UPDEBUG	UPDATE DEBUG	UPDEBUG	2- 41
UPUSER	UPDATE USER FLASH	UPUSER	2- 42
VERSION	SHOW VERSION	VERSION	2- 43

ADD DEBUG COMMANDS *****

2.4.1. AS - Assemble

AS

Usage: AS <addr> <instruction>

The AS command assembles instructions. The value for addr may be an absolute address specified as a hexadecimal value, or a symbol name. Instruction may be any valid instruction for the target processor.

The assembler keeps track of the address where the last instruction's opcode was written. If no address is provided to the AS command and the AS command has not been used since system reset, then AS defaults to the beginning address of user-space for the target board.

If no instruction is passed to the AS command, then AS prompts with the address where opcode will be written, and continues to assemble instructions until the user terminates the AS command by inputting a period, ".".

The inline assembler permits the use of case-sensitive symbols defined by equate statements and labels which are stored in the symbol table. The syntax for defining symbols and labels is as follows:

```
Symbol    equ    value
Symbol:   equ    value
Symbol    .equ   value
Symbol:   .equ   value
Label:    instruction
Label:
```

Constants and operands may be input in several different bases:

```
0x        followed by hexadecimal constant
$         followed by hexadecimal constant
@         followed by octal constant
%         followed by binary constant
digit     decimal constant
```

The assembler also supports the different syntax for the indexed, displacement and immediate addressing modes:

```
(12,An)   or    12(An)
(4,PC,Xn) or    4(PC,Xn)
```

Freescale Semiconductor, Inc.

(0x1234).Lor 0x1234.L

Examples:

To assemble one 'move' instructions at the next assemble address, the command is:

```
as move.l #0x25,d0
```

To assemble multiple lines at 0x12000, the command is:

```
as 12000
```

then:

```
0x00012000: start: nop
0x00012002: nop
0x00012004: lsr.l#1,d0
0x00012006: cmp #4,d0
0x00012008: beq start
```

2.4.2. BC - Compare Blocks of Memory

BC

Usage: BC first second length

The BC command compares two contiguous blocks of memory the first block starting at address 'first', the second block starting at address 'second', both of length 'length'. If the blocks are not identical, then the addresses of the first mismatch are displayed. The value for addresses 'first' and 'second' may be an absolute address specified as a hexadecimal value or a symbol name. The value for length may be a symbol name or a number converted according to the user defined radix, normally hexadecimal.

Examples:

To verify that the code in the first block of user FLASH space (128K) is identical to the code in user SDRAM space, the command is,

```
bc      20000 FFE20000 20000
```

2.4.3. *BF* - Block of Memory Fill

BF

Usage: *BF*<width> begin end data

The *BF* command fills a contiguous block of memory starting at address begin, stopping at address end, with the value data. Width modifies the size of the data that is written.

The value for addresses begin and end may be an absolute address specified as a hexadecimal value, or a symbol name. The value for data may be a symbol name, or a number converted according to the user defined radix, normally hexadecimal.

This command first aligns the starting address for the data access size and then increments the address accordingly during the operation. Thus, for the duration of the operation, this command performs properly aligned memory accesses.

Examples:

To fill a memory block starting at 0x00010000 and ending at 0x00040000 with the value 0x1234, the command is:

```
bf 10000 40000 1234
```

To fill a block of memory starting at 0x00010000 and ending at 0x00040000 with a byte value of 0xAB, the command is:

```
bf.b 10000 40000 AB
```

To zero out the BSS section of the target code (defined by the symbols *bss_start* and *bss_end*), the command is:

```
bf bss_start bss_end 0
```

2.4.4. *BM - Block Move*

BM

Usage: BM begin end dest

The BM command moves a contiguous block of memory starting at address begin, stopping at address end, to the new address dest. The BM command copies memory as a series of bytes, and does not alter the original block.

The value for addresses begin, end, and dest may be an absolute address specified as a hexadecimal value, or a symbol name. If the destination address overlaps the block defined by begin and end, an error message is produced and the command exits.

Examples:

To copy a block of memory starting at 0x00040000 and ending at 0x00080000 to the location 0x00200000, the command is:

```
bm 40000 80000 200000
```

To copy the target code's data section (defined by the symbols data_start and data_end) to 0x00200000, the command is:

```
bm data_start data_end 200000
```

2.4.5. BR - Breakpoint

BR

Usage: BR addr <-r> <-c count> <-t trigger>

The BR command inserts or removes breakpoints at address addr. The value for addr may be an absolute address specified as a hexadecimal value, or a symbol name. Count and trigger are numbers converted according to the user-defined radix, normally hexadecimal.

If no argument is provided to the BR command, a listing of all defined breakpoints is displayed.

The -r option to the BR command removes a breakpoint defined at address addr. If no address is specified in conjunction with the -r option, then all breakpoints are removed.

Each time a breakpoint is encountered during the execution of target code, its count value is incremented by one. By default, the initial count value for a breakpoint is zero, but the -c option allows setting the initial count for the breakpoint.

Each time a breakpoint is encountered during the execution of target code, the count value is compared against the trigger value. If the count value is equal to or greater than the trigger value, a breakpoint is encountered and control returned to dBUG. By default, the initial trigger value for a breakpoint is one, but the -t option allows setting the initial trigger for the breakpoint.

If no address is specified in conjunction with the -c or -t options, then all breakpoints are initialized to the values specified by the -c or -t option.

Examples:

To set a breakpoint at the C function main(), the command is:

```
br _main
```

When the target code is executed and the processor reaches main(), control will be returned to dBUG.

To set a breakpoint at the C function bench() and set its trigger value to 3, the command is:

```
br _bench -t 3
```

Freescale Semiconductor, Inc.

When the target code is executed, the processor must attempt to execute the function bench() a third time before returning control back to dBUG.

To remove all breakpoints, the command is:

```
br -r
```

2.4.6. BS - Block Search

BS

Usage: BS<width> begin end data

The BS command searches a contiguous block of memory starting at address begin, stopping at address end, for the value data. Width modifies the size of the data that is compared during the search.

The value for addresses begin and end may be an absolute address specified as a hexadecimal value, or a symbol name. The value for data may be a symbol name, or a number converted according to the user defined radix, normally hexadecimal.

This command first aligns the starting address for the data access size, and then increments the address accordingly during the operation. Thus, for the duration of the operation, this command performs properly aligned memory accesses.

Examples:

To search for the 16-bit value 0x1234 in the memory block starting at 0x00040000 and ending at 0x00080000 the command is:

```
bs 40000 80000 1234
```

This reads the 16-bit word located at 0x00040000 and compares it against the 16-bit value 0x1234. If no match is found, then the address is incremented to 0x00040002 and the next 16-bit value is read and compared.

To search for the 32-bit value 0xABCD in the memory block starting at 0x00040000 and ending at 0x00080000, the command is:

```
bs.l 40000 80000 ABCD
```

This reads the 32-bit word located at 0x00040000 and compares it against the 32-bit value 0x0000ABCD. If no match is found, then the address is incremented to 0x00040004 and the next 32-bit value is read and compared.

To search the BSS section (defined by the symbols bss_start and bss_end) for the byte value 0xAA, the command is:

```
bs.b bss_start bss_end AA
```

2.4.7. DATA - Data Conversion

DATA

Usage: DATA data

The DATA command displays data in both decimal and hexadecimal notation.

The value for data may be a symbol name or an absolute value. If an absolute value passed into the DATA command is prefixed by '0x', then data is interpreted as a hexadecimal value. Otherwise data is interpreted as a decimal value.

All values are treated as 32-bit quantities.

Examples:

To display the decimal equivalent of 0x1234, the command is:

```
data 0x1234
```

To display the hexadecimal equivalent of 1234, the command is:

```
data 1234
```

2.4.8. *DI - Disassemble*

DI

Usage: DI <addr>

The DI command disassembles target code pointed to by addr. The value for addr may be an absolute address specified as a hexadecimal value, or a symbol name.

Wherever possible, the disassembler will use information from the symbol table to produce a more meaningful disassembly. This is especially useful for branch target addresses and subroutine calls.

The DI command attempts to track the address of the last disassembled opcode. If no address is provided to the DI command, then the DI command uses the address of the last opcode that was disassembled.

Examples:

To disassemble code that starts at 0x00040000, the command is:

```
di 40000
```

To disassemble code of the C function main(), the command is:

```
di _main
```

2.4.9. DL - Download Serial DL

Usage: DL <offset>

The DL command performs an S-record download of data obtained from the serialport. The value for offset is converted according to the user defined radix, normally hexadecimal.

If offset is provided, then the destination address of each S-record is adjusted by offset. The DL command checks the destination address for validity. If the destination is an address below the defined user space (0x00000000-0x00020000), then an error message is displayed and downloading aborted. If the S-record file contains the entry point address, then the program counter is set to reflect this address.

Examples:

To download an S-record file through the serial port, the command is:

```
dl
```

To download an S-record file through the serial port, and adjust the destination address by 0x40, the command is:

```
dl 0x40
```

2.4.10. DN - Download Network

DN

Usage: DN <-c> <-e> <-i> <-s> <-o offset> <filename>

The DN command downloads code from the network. The DN command handles files which are either S-record, COFF or ELF formats. The DN command uses Trivial File Transfer Protocol, TFTP, to transfer files from a network host.

In general, the type of file to be downloaded and the name of the file must be specified to the DN command. The -c option indicates a COFF download, the -e option indicates an ELF download, -I option indicates an image download, and the -s indicates an S-record download. The -o option works only in conjunction with the -s option to indicate an optional offset for S-record download. The filename is passed directly to the TFTP server and, therefore, must be a valid filename on the server.

If neither of the -c, -e, -i, -s or filename options are specified, then a default filename and file type will be used. Default filename and file type parameters are manipulated using the set and show commands.

The DN command checks the destination address for validity. If the destination is an address below the defined user space, then an error message is displayed and downloading is aborted.

For ELF and COFF files which contain symbolic debug information, the symbol tables are extracted from the file during download and used by dBUG. Only global symbols are kept in dBUG. The dBUG symbol table is not cleared prior to downloading, so it is the user's responsibility to clear the symbol table as necessary prior to downloading.

If an entry point address is specified in the S-record, COFF or ELF file, the program counter is set accordingly.

Examples:

To download an S-record file with the name "srec.out", the command is:

```
dn -s srec.out
```

To download a COFF file with the name "coff.out", the command is:

```
dn -c coff.out
```

Freescale Semiconductor, Inc.

To download a file using the default filetype with the name "bench.out", the command is:

```
dn bench.out
```

To download a file using the default filename and filetype, the command is:

```
dn
```

This command requires proper Network address and parameter setup. Refer to Appendix A for this procedure.

2.4.11. *Go - Execute*

GO

Usage: GO <addr>

The GO command executes target code starting at address *addr*. The value for *addr* may be an absolute address specified as a hexadecimal value, or a symbol name.

If no argument is provided, the GO command begins executing instructions at the current program counter.

When the GO command is executed, all user-defined breakpoints are inserted into the target code, and the context is switched to the target program. Control is only regained when the target code encounters a breakpoint, illegal instruction, or other exception which causes control to be handed back to dBUG.

Examples:

To execute code at the current program counter, the command is:

```
go
```

To execute code at the C function `main()`, the command is:

```
go _main
```

To execute code at the address `0x00040000`, the command is:

```
go 40000
```

2.4.12. *GT - Execute Till a Temporary Breakpoint* GT

Usage: GT <addr>

The GT command executes the target code starting at address in PC (whatever the PC has) until a temporary breakpoint as given in the command line is reached.

Example:

To execute code at the current program counter and stop at breakpoint address 0x10000, the command is:

```
GT 10000
```

2.4.13. *HELP - Help*

HE

Usage: HELP <command>

The HELP command displays a brief syntax of the commands available within dBUG. In addition, the address of where user code may start is given. If command is provided, then a brief listing of the syntax of the specified command is displayed.

Examples:

To obtain a listing of all the commands available within dBUG, the command is

```
help
```

The help list is longer than one page. The help command displays one screen full and ask for an input to display the rest of the list.

To obtain help on the breakpoint command, the command is:

```
help br
```

2.4.14. *IRD - Internal Registers Display*

IRD

Usage: IRD <module.register>

This command displays the internal registers of different modules inside the MCF5307. In the command line, the module refers to the module name where the register is located and the register refers to the specific register needed.

The registers are organized according to the module to which they belong. The available modules on the MCF5307 are SIM, UART1, UART2, TIMER, M-Bus, DRAMC, and Chip-Select. Refer to MCF5307 User's Manual.

Example:

```
ird sim.sypcr           ;display the SYPCR register in the SIM module.
```

2.4.15. *IRM - Internal Registers MODIFY* IRM

Usage: IRM module.register data

This commands modifies the contents of the internal registers of different modules inside the MCF5307. In the command line, the module refers to the module name where the register is located, register refers to the specific register needed, and data is the new value to be written into that register.

The registers are organized according to the module to which they belong. The available modules on the MCF5307 are SIM, UART1, UART2, TIMER, M-Bus, DRAMC, Chip-Select. Refer to MCF5307 User's Manual.

Example:

```
irm timer.tmr1 0021           ;write 0021 into TMR1 register in the  
TIMER module.
```

2.4.16. MD - Memory Display

MD

Usage: MD<width> <begin> <end>

The MD command displays a contiguous block of memory starting at address begin and stopping at address end. The value for addresses begin and end may be an absolute address specified as a hexadecimal value, or a symbol name. Width modifies the size of the data that is displayed.

Memory display starts at the address begin. If no beginning address is provided, the MD command uses the last address that was displayed. If no ending address is provided, then MD will display memory to an address that is 128 beyond the starting address.

This command first aligns the starting address for the data access size, and then increments the address accordingly during the operation. Thus, for the duration of the operation, this command performs properly aligned memory accesses.

Examples:

To display memory at address 0x00400000, the command is:

```
md 400000
```

To display memory in the data section (defined by the symbols data_start and data_end), the command is:

```
md data_start
```

To display a range of bytes from 0x00040000 to 0x00050000, the command is:

```
md.b 40000 50000
```

To display a range of 32-bit values starting at 0x00040000 and ending at 0x00050000, the command is:

```
md.l 40000 50000
```

This command may be repeated by simply pressing the carriage-return (Enter) key. It will continue with the address after the last display address.

2.4.17. MM - Memory Modify

Usage: MM<width> addr <data>

The MM command modifies memory at the address addr. The value for address addr may be an absolute address specified as a hexadecimal value, or a symbol name. Width modifies the size of the data that is modified. The value for data may be a symbol name, or a number converted according to the user defined radix, normally hexadecimal.

If a value for data is provided, then the MM command immediately sets the contents of addr to data. If no value for data is provided, then the MM command enters into a loop. The loop obtains a value for data, sets the contents of the current address to data, increments the address according to the data size and repeats. The loop terminates when an invalid entry for the data value is entered, i.e., a period.

This command first aligns the starting address for the data access size, and then increments the address accordingly during the operation. Thus, for the duration of the operation, this command performs properly aligned memory accesses.

Examples:

To set the byte at location 0x00010000 to be 0xFF, the command is:

```
mm.b      10000 FF
```

To interactively modify memory beginning at 0x00010000, the command is:

```
mm      10000
```

2.4.18. *RD* - Register Display

RD

Usage: *RD* <reg>

The *RD* command displays the register set of the target. If no argument for *reg* is provided, then all registers are displayed. Otherwise, the value for *reg* is displayed.

Examples:

To display all the registers and their values, the command is:

```
rd
```

To display only the program counter, the command is:

```
rd pc
```

2.4.19. *RM - Register Modify*

RM

Usage: RM reg data

The RM command modifies the contents of the register reg to data. The value for reg is the name of the register, and the value for data may be a symbol name, or it is converted according to the user defined radix, normally hexadecimal.

dBUG preserves the registers by storing a copy of the register set in a buffer. The RM command updates the copy of the register in the buffer. The actual value will not be written to the register until target code is executed.

Examples:

To change register D0 to contain the value 0x1234, the command is:

```
rm D0 1234
```

2.4.20. *RESET* - *Reset the board and dBUG*
RESET

Usage: RESET

The RESET command attempts to reset the board and dBUG to their initial power-on states.

The RESET command executes the same sequence of code that occurs at power-on. This code attempts to initialize the devices on the board and dBUG data structures. If the RESET command fails to reset the board to your satisfaction, cycle power or press the reset button.

Examples:

To reset the board and clear the dBUG data structures, the command is:

```
reset
```

2.4.21. SET - Set Configuration

SET

Usage: SET option <value>

SET

The SET command allows the setting of user configurable options within dBUG. The options are listed below. If the SET command is issued without option, it will show the available options and values.

The board needs a RESET after this command in order for the new option(s) to take effect.

baud - This is the baud rate for the first serial port on the board. All communications between dBUG and the user occur using either 9600 or 19200 bps, eight data bits, no parity, and one stop bit, 8N1. Do not choose 38400 baud.

base - This is the default radix for use in converting number from their ASCII text representation to the internal quantity used by dBUG. The default is hexadecimal (base 16), and other choices are binary (base 2), octal (base 8), and decimal (base 10).

client - This is the network Internet Protocol, IP, address of the board. For network communications, the client IP is required to be set to a unique value, usually assigned by your local network administrator.

server - This is the network IP address of the machine which contains files accessible via TFTP. Your local network administrator will have this information and can assist in properly configuring a TFTP server if one does not exist.

gateway - This is the network IP address of the gateway for your local subnetwork. If the client IP address and server IP address are not on the same subnetwork, then this option must be properly set. Your local network administrator will have this information.

netmask - This is the network address mask to determine if use of a gateway is required. This field must be properly set. Your local network administrator will have this information.

Freescale Semiconductor, Inc.

filename - This is the default filename to be used for network download if no name is provided to the DN command.

filetype- This is the default filetype to be used for network download if no type is provided to the DN command. Valid values are: "s-record", "coff", "image", and "elf".

autoboot - This option allows for the automatic downloading and execution of a file from the network. This option can be used to automatically boot an operating system from the network. Valid values are: "on" and "off". This option is not implemented on the current of dBUG.

nicbase - this is base address of the network interface. This command is used to inform the dBUG of the address of the network interface. The default value shows 0x0000. However, this parameter is hard coded to 0x300. *DO NOT CHANGE THIS OPTION.*

macaddr - This is the ethernet MAC address of the board. For network communications, the MAC address is required to be set to a unique value. Any address that is not already in use is suitable.

Examples:

To see all the available options and supported choices, the command is:

```
set
```

To set the baud rate of the board to be 19200, the command is:

```
set baud 19200
```

Now press the RESET button (RED) or RESET command for the new baud to take effect. This baud will be programmed in flash ROM and will be used during the power-up.

2.4.22. *SHOW* - Show Configuration

SHOW

Usage: SHOW option
 SHOW

The SHOW command displays the settings of the user configurable options within dBUG. Most options configurable via the SET command can be displayed with the SHOW command. If the SHOW command is issued without any option, it will show all options.

Examples:

To display all the current options, the command is:

```
show
```

To display the current baud rate of the board, the command is:

```
show        baud
```

To display the TFTP server IP address, the command is:

```
show        server
```

2.4.23. STEP - Step Over

ST

Usage: STEP

The ST command can be used to "step over" a subroutine call, rather than tracing every instruction in the subroutine. The ST command sets a breakpoint one instruction beyond the current program counter and then executes the target code.

The ST command can be used for BSR and JSR instructions. The ST command will work for other instructions as well, but note that if the ST command is used with an instruction that will not return, i.e. BRA, then the temporary breakpoint may never be encountered and thus dBUG may not regain control.

Examples:

To pass over a subroutine call, the command is:

```
step
```

2.4.24. *SYMBOL* - Symbol Name Management

SYMBOL

Usage: `SYMBOL <symp> <-a symp value> <-r symp> <-c|l|s>`

The `SYMBOL` command adds or removes symbol names from the symbol table. If only a symbol name is provided to the `SYMBOL` command, then the symbol table is searched for a match on the symbol name and its information displayed.

The `-a` option adds a symbol name and its value into the symbol table. The `-r` option removes a symbol name from the table.

The `-c` option clears the entire symbol table, the `-l` option lists the contents of the symbol table, and the `-s` option displays usage information for the symbol table.

Symbol names contained in the symbol table are truncated to 31 characters. Any symbol table lookups, either by the `SYMBOL` command or by the disassembler, will only use the first 31 characters. Symbol names are case sensitive.

Examples:

To define the symbol "main" to have the value 0x00040000, the command is:

```
symbol -a main 40000
```

To remove the symbol "junk" from the table, the command is:

```
symbol -r junk
```

To see how full the symbol table is, the command is:

```
symbol -s
```

To display the symbol table, the command is:

```
symbol -l
```

2.4.25. TRACE - Trace Into

TR

Usage: TRACE <num>

The TRACE command allows single instruction execution. If num is provided, then num instructions are executed before control is handed back to dBUG. The value for num is a decimal number.

The TRACE command sets bits in the processors' supervisor registers to achieve single instruction execution, and the target code executed. Control returns to dBUG after a single instruction execution of the target code.

Examples:

To trace one instruction at the program counter, the command is:

```
tr
```

To trace 20 instructions from the program counter, the command is:

```
tr 20
```

2.4.26. *UPDEBUG* - *Update the dBUG Image* UPDEBUG

Usage: UPDEBUG

The UPDEBUG command is used for updating the dBUG image in Flash. When updates to the MCF5307 EVS dBUG are available, the updated image is downloaded to address 0x00020000. The new image is placed into Flash using the UPDEBUG command. The user is prompted for verification before performing the operation. Use this command with extreme caution, as any error can render dBUG, and thus the board, useless!

2.4.27. *UPUSER* - Update User Code In Flash

UPUSER

Usage: *UPUSER* <number of sectors>

The *UPUSER* command places user code and data into space allocated for the user in Flash. There are six sectors of 128K each available as user space. To place code and data in user Flash, the image is downloaded to address 0x00020000, and the *UPUSER* command issued. This command programs all six sectors of user Flash space. ~~Uses~~ ~~this~~ space starting at address 0xFFE20000. To program less than six sectors, supply the number of sectors you wish to program after the *UPUSER* command.

Examples:

To program all 6 sectors of user FLASH space, the command is:

upuser or upuser 6

To program only 128K of user FLASH space, the command is:

upuser 1

Freescale Semiconductor, Inc.

VERSION - Display dBUG Version

VERSION

Usage: VERSION

The VERSION command display the version information for dBUG. The dBUG version number and build date are both given.

The version number is separated by a decimal, for example, "v1.1". The first number indicates the version of the CPU specific code, and the second number indicates the version of the board specific code.

The version date is the day and time at which the entire dBUG monitor was compiled and built.

Examples:

To display the version of the dBUG monitor, the command is:

version

2.5 TRAP #15 Functions

An additional utility within the dBUG firmware is a function called the TRAP : handler. This function can be called by the user program to utilize various routines within the dBUG, to perform a special task, and to return control to the dBUG. This section describes the TRAP 15 handler and how it is used.

There are four TRAP #15 functions. These are: OUT_CHAR, IN_CHAR, CHAR_PRESENT, and EXIT_TO_dBUG.

2.5.1. OUT_CHAR

This function (function code 0x0013) sends a character, which is in lower 8 bits of D1, to terminal.

Assembly example:

```
/* assume d1 contains the character */
move.l      #$0013,d0 Selects the function
TRAP      #15      The character in d1 is sent to terminal
```

C example:

```
void board_out_char (int ch)
{
    /* If your C compiler produces a LINK/UNLK pair for this routine,
     * then use the following code which takes this into account
     */
    #if 1
    /* LINK a6,#0 -- produced by C compiler */
    asm (" move.l 8(a6),d1")/* put 'ch'into d1 */
    asm (" move.l #0x0013,d0"); /* select the function */
    asm (" trap #15"); /* make the call */
    /* UNLK a6 -- produced by C compiler */
    #else
    /* If C compiler does not produce a LINK/UNLK pair, the use
     * the following code.
     */
    asm (" move.l 4(sp),d1")/* put 'ch'into d1 */
    asm (" move.l #0x0013,d0"); /* select the function */
    asm (" trap #15"); /* make the call */
    #endif
}
```

```
#endif  
}
```

2.5.2. *IN_CHAR*

This function (function code 0x0010) returns an input character (from terminal) to the caller. The returned character is in D1.

Assembly example:

```
    move.l    #$0010,d0 Select the function  
    trap #15      Make the call, the input character is in d1.
```

C example:

```
int board_in_char (void)  
{  
    asm (" move.l    #0x0010,d0");      /* select the function */  
    asm (" trap      #15");             /* make the call */  
    asm (" move.l    d1,d0");           /* put the character in d0 */  
}
```

2.5.3. *CHAR_PRESENT*

This function (function code 0x0014) checks if an input character is present to receive. A value of zero is returned in D0 when no character is present. A non-zero value in D0 means a character is present.

Assembly example:

```
    move.l    #$0014,d0 Select the function  
    trap #15      Make the call, d0 contains the response (yes/no).
```

C example:

```
int board_char_present (void)  
{  
    asm (" move.l    #0x0014,d0");      /* select the function */  
    asm (" trap      #15");             /* make the call */  
}
```

2.5.4. EXIT_TO_dBUG

This function (function code 0x0000) transfers the control back to the dBUG, terminating the user code. The register context are preserved.

Assembly example:

```
move.l    #$0000,d0 Select the function
trap #15      Make the call,  exit to dBUG.
```

C example:

```
void board_exit_to_dbug (void)
{
    asm (" move.l    #0x0000,d0"); /* select the function */
    asm (" trap      #15");        /* exit and transfer to dBUG */
}
```

This chapter provides a functional description of the M5307C3 board hardware. With the description given here and the schematic diagram provided at the end of this manual, the user can gain a good understanding of the board's design. In this manual, an active low signal is indicated by a "-" preceding the signal name in this text and a bar over the signal name in the schematics.

3.1 THE PROCESSOR AND SUPPORT LOGIC

This part of the Chapter discusses the CPU and general supporting logic on the M5307C3 board.

3.1.1. The Processor

The microprocessor used in the M5307C3 is the highly integrated MCF5307, 32-bit processor. The MCF5307 uses a ColdFire® processor as the core with 8K bytes of unified cache, two UART channels, two Timers, 4K bytes of SRAM, Motorola M-Bus Module supporting the I²C, two-byte wide parallel I/O port, and the supporting integrated system logic. All the registers of the core processor are 32 bit wide except for the Status Register (SR) which is 16 bits wide. This processor communicates with external devices over a 32-bit wide data bus, D0-D31 with support for 8 and 16-bit ports. This chip addresses 4 G Bytes of memory space using internal chip-select logic. All the processor's signals are available through micro connectors, LA1, LA2, LA3, LA4, LA5 and through 100 mil headers J1, J3, J4, and J5. Refer to section 3.7 for pin assignment.

The MCF5307 has an IEEE JTAG-compatible port and BDM port used with third party tools. These signals are available on port J1. The processor also has the logic to generate up to eight (8) chip selects, -CS0 to -CS7, and support for 2 banks of ADRAM (not on evaluation board) or 2 banks of SDRAM (on evaluation board).

3.1.2. *The Reset Logic*

The reset logic provides system initialization. The reset occurs during power-on and asserts the signal -RSTI which causes total system reset. The reset is also triggered by the red reset switch and resets the entire processor.

U5 is used to produce active low power-on RESET signal which feeds into the ispLSI2032. The reset switch is fed into U4 which generates a signal into U5 which then drive U9's input for reset. The U9 device generates the system reset (-CF_RSTI) and Ethernet RESET (ETH_RST) signals.

ROM Monitor performs the following configurations of internal resources during the initialization. The instruction cache is disabled and disabled. The Vector Base Register, VBR, points to the Flash. However, a copy of the exception table is made at address \$00000000 in the SDRAM.

The Software Watchdog Timer is disabled, Bus Monitor enabled, and internal timers are placed in a stop condition. Interrupt controller registers are initialized with unique interrupt level/priority pairs. The parallel I/O port is configured for I/O.

3.1.3. *The -HIZ Signal*

The -HIZ signal is actively driven by the LSI2032 (U9). This signal is available for monitor on connector LA3 and J5. This signal should not be driven by the user.

3.1.4. *The Clock Circuitry*

The M5307C3 uses a 45MHz oscillator (U22) to provide the clock CLKIN pin of the processor. In addition to U22, there also exist a 20MHz oscillator (U6) which feeds into the Ethernet chip. The bus clock out of the MCF5307 drives a clock buffer chip (U18) which is fed into the edge select pin of the MCF5307, the ispLSI2032 for Ethernet timing (1/4 bus clock), SRAM (U19), and SDRAM (U23).

3.1.5. *Watchdog Timer*

The duration of the Watchdog is selected by BMT0-1 bits in System Protection Register. The dBUG initializes this register with the value 00, which provides for 1024 system clock time-out but dBUG does not enable it.

3.1.6. Interrupt Sources

The ColdFire® family of processors can receive interrupts for seven levels of interrupt priorities. When the processor receives an interrupt which has higher priority than the current interrupt (in status register) it will perform an interrupt acknowledge cycle at the end of the current instruction cycle. This interrupt acknowledge cycle indicates to the source of the interrupt that the request is being acknowledged and the device should provide the proper vector number to indicate where the service routine for this interrupt level is located. If the source of interrupt is not capable of providing a vector, its interrupt should be set up as auto vector interrupt which directs the processor to a predefined entry into the exception table (refer to the MCF5307 User's Manual).

The processor goes to an exception routine via the exception table. This table is in the Flash and the VBR points to it. However, a copy of this table is made in the RAM starting at \$00000000. To set an exception vector, the user places address of the exception handler in the appropriate vector in the vector table located at \$00000000, and then points the VBR to \$00000000.

The MCF5307 has four external interrupt request lines. You can program the external interrupt request pins to level 1, 3, 5, and 7 or levels 2, 4, 6, and 7. The M5307C3 configures these lines as level 1, 3, 5, and 7. There are also six internal interrupt requests from Timer1, Timer2, Software watchdog timer, UART1, UART2, and MBUS. Each interrupt source, external and internal, can be programmed for any priority level. In case of similar priority level, a second relative priority between 0 to 3 will be assigned.

However, the software watchdog is programmed for Level 7, priority 2 and uninitialised vector. The UART1 is programmed for Level 3, priority 2 and auto vector. The UART2 is programmed for Level 3, priority 1 and auto vector. The M-Bus is at Level 3, priority 0 and auto vector. The Timers are at Level 5 with Timer 1 with priority 3 and Timer 2 with priority 2 and both for auto vector.

NOTE: No interrupt sources should have the same level and priority as another.

The M5307C3 uses -IRQ7 to support the ABORT function using the ABORT switch S1 (black switch). This switch is used to force a non-maskable interrupt (level 7, priority 3) if the user's program execution should be aborted without issuing a RESET (refer to Chapter 2 for more information on ABORT). Since the ABORT switch is not capable of generating a vector in response to level seven interrupt acknowledge from the processor, the debugger programs this request for autovector mode.

The -IRQ1 line of the MCF5307 is not used on this board. However, the -IRQ1 is programmed for Level 1 with priority and autovector. The user may use this line for external interrupt request. Refer to MCF5307 User's Manual for more information about the interrupt controller.

3.1.7. Internal SRAM

The MCF5307 has 4K of internal memory. This memory is mapped to 0x20000000 and is not used by the dBUG. It is available to the user. The memory is relocatable to 32K byte boundary.

3.1.8. The MCF5307 Registers and Memory Map

The memory and I/O resources of the M5307C3 are divided into three groups, MCF5307 Internal, External resources, and the ethernet controller. All the I/O registers are memory mapped.

The MCF5307 has built-in logic and up to eight chip-select pins (-CS0 to -CS7) which are used to enable external memory and I/O devices. In addition there are two -RAS lines for DRAM's. There are registers to specify the address range, type of access, and the method of -TA generation for each chip-select and -RAS pins. These registers are programmed by dBUG to map the external memory and I/O devices.

The M5307C3 uses chip-select zero (-CS0) to enable the Flash ROM's (refer to Section 3.3.) The M5307C3 uses -RAS1, -RAS2, -CAS0, -CAS1, -CAS2, and -CAS3 to enable the SDRAM DIMM module (refer to Section 3.2), -CS2 for SRAM (not populated), and -CS3 for Ethernet Bus I/O space.

The chip select mechanism of the MCF5307 allows the memory mapping to be defined based on the memory space desired (User/Supervisor, Program/Data spaces).

Freescale Semiconductor, Inc.

All the MCF5307 internal registers, configuration registers, parallel I/O port registers, DUART registers and system control registers are mapped by MBAR register at any 1K-byte boundary. It is mapped to 0x10000000 by dBUG. For complete map of these registers refer to the MCF5307 User's Manual.

The M5307C3 board can have up to 16M bytes of SDRAM installed. The first 16M bytes are reserved for this memory. Refer to Section 3.2 for a discussion of RAM. The dBUG is programmed in two 29LV004B Flash ROM's which only occupies 1M bytes of the address space. The first 128K bytes are used by ROM Monitor and the remainder is left for user use. Refer to section 3.3.

The Ethernet Bus interface maps all the I/O space of the Ethernet bus to the MCF5307 memory at address \$FE600000. Refer to section 3.6.

Table 4 - The M5307C3 memory map

ADDRESS RANGE	SIGNAL and DEVICE
\$00000000-\$00020000	SDRAM space for dBUG ROM Monitor use
\$00020000-\$00FFFFFF	SDRAM space
\$20000000-\$20000FFF	Internal SRAM (4K bytes)
\$30000000-\$300003FF	System Integration Module (SIM) registers
\$40000000-\$400FFFFFF	-CS3, 1M Ethernet Bus area
\$FE400000-\$FE47FFFF ¹	External SRAM (512K bytes; unpopulated)
\$FFE00000-\$FFEFFFFF	-CS0, 1M bytes of Flash ROM.

1. Not installed. Level 2 cache footprint accepts Motorola's MCM69F737TQ chip and any other SRAM with the same electrical specifications and package.

All the unused area of the memory map is available to the user.

3.1.9. Reset Vector Mapping

After reset, the processor attempts to get the initial stack pointer and initial program counter values from locations \$000000-\$000007 (the first eight bytes of memory space). This requires the board to have a nonvolatile memory device in this range with proper information. However, in some systems, it is preferred to have RAM starting at address \$00000000. In MCF5307, the -CS0 responds to any accesses after reset until the CSMR0 is written. Since -CS0 (the global chip select) is connected to Flash ROM's, the Flash ROMs appear to be at address \$00000000 which provides the initial stack pointer and program counter (the first 8 bytes of the Flash ROM). The initialization routine programs the chip-select logic, locates the Flash ROM's to start at \$FFE00000 and configures the rest of the internal and external peripherals.

3.1.10. -TA Generation

The processor starts a bus cycle by providing the necessary information (address, R/*W, etc.) and asserting -TS . The processor then waits for an acknowledgment (-TA) by the addressed device before it can complete the bus cycle. -TA is used not only to indicate the presence of a device, it also allows devices with different access times to communicate with the processor properly. The MCF5307, as part of the chip-select logic, has a built-in mechanism to generate -TA for all external devices which do not have the capability to generate -TA on their own. The Flash ROM and SRAM can not generate -TA . The chip-select logic is programmed by the ROM Monitor to generate -TA internally after a preprogrammed number of wait states. In order to support future expansion of the board, the -TA input of the processor is also connected to the Processor Expansion Bus, J4. This allows the expansion boards to assert this line to indicate their -TA to the processor. On the expansion boards, however, this signal should be generated through an open collector buffer with no pull-up resistor or a pull-up resistor is included on the board. All the -TA 's from the expansion boards should be connected to this line.

3.1.11. Wait State Generator

The Flash ROM and SDRAM DIMM on the board may require some adjustments on the cycle time of the processor to make them compatible with processor speed. To extend the CPU bus cycles for the slower devices, the chip-select logic of the MCF5307 can be programmed to generate -TA after a given number of wait states. Refer to Sections 3.2 and 3.3 for information about the wait state requirements of SDRAM and Flash ROM respectively.

3.2 THE SDRAM DIMM

The M5307C3 one 168-pin DIMM socket (U23) for a SDRAM DIMM. This socket supports SDRAM DIMM's of 1M x 4 x 16-Bits SDRAM x 2. No special configuration is needed. The DIMM speed should be a minimum of 70ns. The SDRAM Access timing is 2,4,2,1,-1 for t_{RCD} , t_{RAS} , t_{RP} , t_{RWL} , and t_{EP} respectively. These timings determine how long the data is delayed after the -CAS signal (or the read command) is asserted during a SDRAM access. This corresponds to the t_{RCD} specifications in most SDRAM. The other timings that correspond to the SDRAM are the active command to precharge command (t_{RAS}), precharge command to active command (t_{RP}), last data input to precharge command (t_{RWL}), and last data out to early precharge (t_{EP}). The ROM monitor sets the default SDRAM access provided to 4-2-2-2 burst. The ROM monitor also uses

the Serial Presence Detect (SPD) functionality of the SDRAM to determine what SDRAM is populated in the evaluation board and configures the system appropriately.

Please refer to the SDRAM Application Note in Appendix E for address muxing

3.3 FLASH ROM

There are two 512Kbyte Flash ROM on the M5307C3, U20 (high, even byte) and U21 (low, odd byte).

The board is shipped with two 29LV004, 512K-byte, FLASH ROM for a total of 1M bytes. The first 128K of the Flash contains ROM Monitor firmware. The last 896K is available to the user. The chip-select signal generated by the MCF5307 (-CS0) enables both chips.

The MCF5307 chip-select logic can be programmed to generate the TA for -CS0 signal after a certain number of wait states. The dBUG programs this parameter to three wait-states.

3.3.1 JP1 Jumper and User's Program

This jumper allows users to test code from the boot without having to overwrite the ROM Monitor.

When the jumper is set between pins 1 and 2, the behavior is normal. When the jumper is set between pins 2 and 3, the board boots from the second half of Flash (0x80000).

Procedure:

1. Compile and link as though the code was to be placed at the base of the flash, but setup so that it will download to the SDRAM starting at address 0x80000. The user should refer to the compiler for this, since it will depend upon the compiler used (using Diab Data, a "LOAD" command in the linker file is used).
2. Set up the jumper for Normal operation, pin 1 connected to pin 2.
3. Download to SDRAM (If using serial or ethernet, start ROM Monitor first. If using BDM via wiggler, download first, then start ROM Monitor by pointing PC to 0xffe00400 and run.)
4. In ROM Monitor, run 'upuser' command.

5. Move jumper to 3.3V and reset, pin 2 connected to pin 3. User code should be running.

3.4 THE SERIAL COMMUNICATION CHANNELS

The M5307C3 offers a number of serial communications. They are discussed in this section.

3.4.1. *The MCF5307 2 UARTs*

The MCF5307 has two builtin UART, each with its own software programmable baud rate generators; one channel is the ROM Monitor to Terminal output and the other is available to the user. The ROM Monitor, however, programs the interrupt level for UART1 to Level 3, priority 2 and autovector mode of operation. The interrupt level for UART2 to Level 3, priority 1 and autovector mode of operation. The signals of these channels are available on port LA1 and LA3. The signals of UART1 and UART2 are also passed through the RS-232 driver/receiver and are available on DB-9 connectors J4 and J7. Refer to the MCF5307 User's Manual for programming and the register map.

3.4.2. *Motorola Bus (M-Bus) Module*

The MCF5307 has a builtin M-Bus module which allows interchip bus interface for a number of I/O devices. It is compatible with industry-standard I²C Bus. The M5307C3 uses this to access the SDRAM eeprom parameters. The two M-Bus signals are SDA and SCL which are available at LA4 connector. These signals are open-collector signals. However, they have pull-up resistors on the M5307C3. These signals are connected to the SDRAM DIMM module I²C interface but not used by the debugger. The interrupt control register for M-Bus is set for Level 3, priority 0 and autovector.

3.5 THE PARALLEL I/O Port

The MCF5307 has one 16-bit parallel port. All the pins have dual functions. They can be configured as I/O or their alternate function via the Pin Assignment register. All parallel port pins are configured as I/O pins by the ROM Monitor.

Freescale Semiconductor, Inc.

P[3:0] connects to the SDRAM mux control and LEDs.

P[7:4] connects to LEDs.

P[15:8] are general purpose parallel port inputs.

3.6 ON BOARD ETHERNET LOGIC

The M5307C3 includes the necessary logic drivers, and the NE2000 compatible Ethernet chip to allow 10M bit transfer rate ~~network~~. The Ethernet-space addresses are located starting at 0x40000000.

The interface base address is 0x300 and uses IRQ3. However, the Ethernet base address in our system as mentioned earlier is 0x40000000. Which brings the address of chip to 0x40000300. Note that all registers should be addressed as WORD accesses (even though the registers are bytes). Note that the even address registers are addressed as they are (no change), the read word will have the byte of the data in the lower byte of the word.

For odd addressed bytes, the address is mapped to 0x400083xx-1. Note that odd-bytes are addressed as even addresses but increased by 0x8000. Still the read byte will be in the lower byte of the read word

Below is an example of the data structure used to define the registers. For the description of the registers refer to the Data Sheet ~~DaVicom~~ DM9008, a copy of this document in on ColdFire Website (<http://www.Motorola.com/ColdFire>).

```
typedef struct
{
    NATURAL16 CR;
    union
    {
        struct
        {
            /* Even registers */
            NATURAL16 CLDA1;    /* CLDA1 (rd) PSTOP (wr) */
            NATURAL16 TSR;     /* TSR (rd) TPSR (wr) */
            NATURAL16 FIFO;    /* FIFO (rd) TBCR1 (wr) */
            NATURAL16 CRDA0;   /* CRDA0 (rd) RSAR0 (wr) */
            NATURAL16 RBCR0;   /* Remote Byte Count 0 (wr) */
            NATURAL16 RSR;     /* RSR (rd) RCR (wr) */
            NATURAL16 CNTR1;   /* CNTR1 (rd) DCR (wr) */

            NATURAL16 DATAPORT;
        }
    }
};
```

Freescale Semiconductor, Inc.

```
NATURAL16 reserved[(0x10000-0x0012)/2];

/* Odd registers */
NATURAL16 CLDA0; /* CLDA0 (rd) PSTART (wr) */
NATURAL16 BNRy; /* Boundary pointer (rd wr) */
NATURAL16 NCR; /* NCR (rd) TBCR0 (wr) */
NATURAL16 ISR; /* Interrupt Status Register (rd wr) */
NATURAL16 CRDA1; /* CRDA1 (rd) RSAR1 (wr) */
NATURAL16 RBCR1; /* Remote Byte Count 1 (wr) */
NATURAL16 CNTR0; /* CNTR0 (rd) TCR (wr) */
NATURAL16 CNTR2; /* CNTR2 (rd) IMR (wr) */
} page0;
struct
{
    /* Even registers */
    NATURAL16 PAR1; /* Physical Address Byte 1 */
    NATURAL16 PAR3; /* Physical Address Byte 3 */
    NATURAL16 PAR5; /* Physical Address Byte 5 */
    NATURAL16 MAR0; /* Multicast Address Byte 0 */
    NATURAL16 MAR2; /* Multicast Address Byte 2 */
    NATURAL16 MAR4; /* Multicast Address Byte 4 */
    NATURAL16 MAR6; /* Multicast Address Byte 6 */

    NATURAL16 reserved[(0x10000-0x0010)/2];

    /* Odd registers */
    NATURAL16 PAR0; /* Physical Address Byte 0 */
    NATURAL16 PAR2; /* Physical Address Byte 2 */
    NATURAL16 PAR4; /* Physical Address Byte 4 */
    NATURAL16 CURR; /* Current Page Register (rd wr) */
    NATURAL16 MAR1; /* Multicast Address Byte 1 */
    NATURAL16 MAR3; /* Multicast Address Byte 3 */
    NATURAL16 MAR5; /* Multicast Address Byte 5 */
    NATURAL16 MAR7; /* Multicast Address Byte 7 */
} page1;
struct
{
    /* Even registers */
    NATURAL16 PSTOP; /* PSTOP (rd) CLDA1 (wr) */
    NATURAL16 TPSR; /* Transmit Page Start Address (rd) */
    NATURAL16 ACU; /* Address Counter Upper */
    NATURAL16 reserved0;
    NATURAL16 reserved2;
```

Freescale Semiconductor, Inc.

```
NATURAL16 RCR;          /* Receive Configuration Register (rd) *
NATURAL16 DCR;          /* Data Configuration Register (rd) */

NATURAL16 reserved[(0x10000-0x0010)/2];

/* Odd registers */
NATURAL16 PSTART;      /* PSTART (rd) CLDA0 (wr) */
NATURAL16 RNPP;        /* Remote Next Packet Pointer */
NATURAL16 LNPP;        /* Local Next Packet Pointer */
NATURAL16 ACL;         /* Address Counter Lower */
NATURAL16 reserved1;
NATURAL16 reserved3;
NATURAL16 TCR;         /* Transmit Configuration Register (rd)
NATURAL16 IMR;         /* Interrupt Mask Register (rd) */
    } page2;
} regs;
} NS8390;
```

The main purpose for this setup is to allow the use of Ethernet card (NE2000 compatible) to facilitate network download, refer to chapter 2 for network download command (DN). The dBUG driver is 100% NE2000 compatible.

The Ethernet Bus interrupt request line is connected via the 2032V PLD to I

The on board ROM MONITOR is programmed to allow a user to download files from a network to memory in different formats. The current formats supported are S-Record, COFF, ELF, or Image.

3.7 THE CONNECTORS AND THE EXPANSION BUS

There are 8 connectors on the M5307C3 which are used to connect the board to external I/O devices and or expansion boards. This section provides a brief discussion and the pin assignments of the connectors.

3.7.1. The Terminal Connector P4

The signal on UART1 that runs through RS-232 driver/receivers are used to drive the Terminal. The M5307C3 uses a 9-pin D-sub female connector P4 for connecting the board to a terminal or a PC with terminal emulation software.

Freescale Semiconductor, Inc.

The available signals are a working subset of the RS-232C standard. Table 5 - The P4 (Terminal) Connector pin assignments shows the pin assignment.

Table 5 - The P4 (Terminal) Connector pin assignment

PIN NO.	DIRECTION	SIGNAL NAME
1	Output	Data Carrier Detect (shorted to 4 & 6)
2	Output	Receive data
3	Input	Transmit data
4	Input	Data Terminal Ready (shorted to 1 & 6)
5		Signal Ground
6	Output	Data Set Ready (shorted to 1 & 4)
7	Input	Request to Send
8	Output	Clear to Send
9		Not Used

3.7.2. The Auxiliary Serial Communication Connector P3

The MCF5307 has two built-in UARTs. One channel is not used by the M5307C3 ROM Monitor and is available to the user. This signal is available on port P3. The available signals form a working subset of the RS-232C standard. Table 6 shows the pin assignment for P3.

Table 6 - The P3 Connector pin assignment

PIN NO.	DIRECTION	SIGNAL NAME
1	Output	Data Carrier Detect (shorted to 4 & 6)
2	Output	Receive data
3	Input	Transmit data
4	Input	Data Terminal Ready (shorted to 1 & 6)
5		Signal Ground
6	Output	Data Set Ready (shorted to 1 & 4)
7	Input	Request to Send
8	Output	Clear to Send
9		Not Used

3.7.3. Logical Analyzer connectors LA1-5 and Processor Expansion Bus J3, J4, & J5.

All the processor signals are available on 5 micro connectors LA1-5. User may refer to the data sheets for the major parts and the schematic at the end of this manual to obtain an accurate loading capability. A subset of signals are available on J8 and J9 for easier access. Tables 7-14 show the pin assignment for J3, J4, J5, LA1, LA2, LA3, LA4 and LA5 respectively.

Table 7 - The J3 Connector pin assignment

PIN NO.	SIGNAL NAME	PIN NO.	SIGNAL NAME
1	TIN1	2	TT0_PP0
3	TOUT1	4	TT1_PP1
5	TIN0	6	TM0_PP2
7	TOUT0	8	TM1_PP3
9	SCL	10	TM2_PP4
11	SDA	12	DREQ1_PP5
13	-IRQ1	14	DREQ0_PP6

Freescale Semiconductor, Inc.

15	-IRQ5	16	XTIP_PP7
17	- CS0_HEAD ER	18	A24_PP8
19	-BWE0	20	A25_PP9
21	-BWE1	22	A26_PP10
23	-BWE2	24	A27_PP11
25	-BWE3	26	A28_PP12
27	-OE	28	A29_PP13
29	-CS4	30	A30_PP14
31	-CS5	32	A31_PP15
33	-RTS0	34	GND

Freescale Semiconductor, Inc.

Table 8 - The J4 Connector pin assignment

PIN NO.	SIGNAL NAME	PIN NO.	SIGNAL NAME
1	D1	2	D2
3	D0	4	D3
5	A0	6	D4
7	A1	8	D5
9	A2	10	D6
11	A3	12	D7
13	A4	14	D8
15	A5	16	D9
17	A6	18	D10
19	A7	20	D11
21	A8	22	D12
23	A9	24	D13
25	A10	26	D14
27	A11	28	D15
29	A12	30	D16
31	A13	32	D17
33	A14	34	D18
35	A15	36	D19
37	A16	38	D20
39	A17	40	D21
41	A18	42	D22
43	A19	44	D23
45	A20	46	D24
47	A21	48	D25
49	A22	50	D26
51	A23	52	D27
53	R/-W	54	D28
55	-AS	56	D29
57	-TA	58	D30
59	GND	60	D31

Table 9 - The J5 Connector pin assignment

PIN NO.	SIGNAL NAME	PIN NO.	SIGNAL NAME
1	BCLKOHEA DER	2	+3.3

Freescale Semiconductor, Inc.

3	SIZ0	4	SIZ1
5	-BG	6	-BR
7	-BD	8	-IRQ3
9	-IRQ7	10	-CS1
11	-CS2	12	-CS3
13	-CS6	14	-CS7
15	-CF_RSTI	16	-TS
17	TXD1	18	TXD2
19	RXD1	20	RXD2
21	-RTS1	22	-RTS2
23	-CTS1	24	-CTS2
25	MTMOD0	26	-HIZ
27	- R_CAS0/D QM0	28	- R_CAS1/DQ M1
29	- R_CAS2/D QM2	30	- R_CAS3/DQ M3
31	- R_RAS0SO 0	32	- R_RAS1_SO 2
33	- R_DRAMW	34	-R_SRAS
35	-R_SCAS	36	R_SCKE
37	+5	38	GND

Table 10 - The LA2 Connector pin assignment

PIN NO.	SIGNAL NAME	PIN NO.	SIGNAL NAME
1	NC	2	NC
3	NC	4	A0
5	A1	6	A3
7	A5	8	A7
9	A9	10	A11
11	A13	12	A15
13	A17	14	A19
15	A21	16	A23
17	A25_PP9	18	A27_PP11

Freescale Semiconductor, Inc.

19	A29_PP13	20	A31_PP15
21	A30_PP14	22	A28_PP12
23	A26_PP10	24	A24_PP8
25	A22	26	A20
27	A18	28	A16
29	A14	30	A12
31	A10	32	A8
33	A6	34	A4
35	A2	36	NC
37	NC	38	NC
39	GND	40	GND
41	GND	42	GND
43	GND		

Freescale Semiconductor, Inc.

Table 11 - The LA1 Connector pin assignment

PIN NO.	SIGNAL NAME	PIN NO.	SIGNAL NAME
1	NC	2	NC
3	NC	4	TXD1
5	TXD2	6	NC
7	NC	8	SIZ0
9	-CS0	10	-BG
11	-RST0	12	-IRQ3
13	-CF_RST1	14	-TA
15	-CS4	16	-CS3
17	-CS2	18	-AS
19	-IRQ5	20	-BR
21	-TS	22	-CS5
23	-CS6	24	-CS7
25	R/-W	26	-IRQ7
27	-IRQ1	28	-BD
29	-CS1	30	-OE
31	SIZ1	32	NC
33	NC	34	NC
35	NC	36	NC
37	NC	38	NC
39	GND	40	GND
41	GND	42	GND
43	GND		

Table 12 - The LA3 Connector pin assignment

PIN NO.	SIGNAL NAME	PIN NO.	SIGNAL NAME
1	NC	2	NC
3	PSTCLK	4	PST3
5	PST0	6	PST1
7	PST2	8	DREQ0_PP 6
9	DREQ1_PP 5	10	MTMOD0
11	MTMOD1	12	RXD2
13	-RTS2	14	RXD1

Freescale Semiconductor, Inc.

15	MTMOD2	16	DSCLK_- TRST
17	DSI_TDI	18	TCK
19	- BKPT_TMS	20	-HIZ
21	DSO_TDO	22	-CTS2
23	-CTS1	24	-RTSI
25	MTMOD3	26	DDATA0
27	DDATA1	28	DDATA2
29	DDATA3	30	XTIP_PP7
31	TMO_PP2	32	TM1_PP3
33	TT0_PP0	34	TM2_PP4
35	TT1_PP1	36	NC
37	NC	38	NC
39	GND	40	GND
41	GND	42	GND
43	GND		

Freescale Semiconductor, Inc.

Table 13 - The LA4 Connector pin assignment

PIN NO.	SIGNAL NAME	PIN NO.	SIGNAL NAME
1	NC	2	NC
3	BCLKOB	4	-R_RAS0
5	-R_CAS2	6	-R_RAS1
7	-R_CAS0	8	-R_CAS1
9	-R_CAS3	10	-R_SRAS
11	- R_DRAMW	12	-R_SCAS
13	R_SCKE	14	TIN0
15	TOUT0	16	PPLTPA
17	EDGSEL	18	SCL
19	SDA	20	NC
21	NC	22	NC
23	NC	24	NC
25	NC	26	NC
27	NC	28	NC
29	NC	30	-BWE0
31	-BWE3	32	-BEW2
33	-BWE1	34	-TIN1
35	TOUT1	36	NC
37	NC	38	NC
39	GND	40	GND
41	GND	42	GND
43	GND		

Table 14 - The LA5 Connector pin assignment

PIN NO.	SIGNAL NAME	PIN NO.	SIGNAL NAME
1	NC	2	NC
3	NC	4	D1
5	D3	6	D5
7	D7	8	D9
9	D11	10	D13
11	D15	12	D17
13	D19	14	D21
15	D23	16	D25

Freescale Semiconductor, Inc.

17	D27	18	D29
19	D31	20	D30
21	D28	22	D26
23	D24	24	D22
25	D20	26	D18
27	D16	28	D14
29	D12	30	D10
31	D8	32	D6
33	D4	34	D2
35	D0	36	BCLKO
37	NC	38	NC
39	GND	40	GND
41	GND	42	GND
43	GND		

Freescale Semiconductor, Inc.

3.7.4. The Debug Connector J1

The MCF5307 does have background Debug Port, Real-Time Trace Support, and Real-Time Debug Support. The necessary signals are available at connector J1. Table 15 - The J1 Connector pin assignment shows the pin assignment.

Table 15 - The J1 Connector pin assignment

PIN NO.	SIGNAL NAME
1	No Connect
2	-BKPT
3	Ground
4	DSCLK
5	Ground
6	No Connect
7	-BDM_RSTI
8	DSI
9	No Connect/+3.3/5V selectable
10	DSO
11	Ground
12	PST3
13	PST2
14	PST1
15	PST0
16	DDATA3
17	DDATA2
18	DDATA1
19	DDATA0
20	Ground
21	Ground thur resistor??BRAD??
22	No Connect
23	Ground
24	PSTCLK
25	+3.3 Volts
26	-TA

APPENDIX A (Configuring dBUG for Network Downloads)

The dBUG module has the ability to perform downloads over an Ethernet network using the Trivial File Transfer Protocol, TFTP. Prior to using this feature, several parameters are required for network downloads to occur. The information that is required and the steps for configuring dBUG are described below.

A.1 Required Network Parameters

For performing network downloads, dBUG needs 6 parameters; 4 are network-related, and 2 are download-related. The parameters are listed below, with the dBUG designation following in parenthesis.

All computers connected to an Ethernet network running the IP protocol need network-specific parameters. These parameters are:

- Internet Protocol, IP, address for the computer (client IP),
- IP address of the Gateway for non-local traffic (gateway IP), and
- Network netmask for flagging traffic as local or non-local (netmask).

In addition, the dBUG network download command requires the following three parameters:

- IP address of the TFTP server (server IP),
- Name of the file to download (filename),
- Type of the file to download (filetype of S-record, COFF, ELF, or Image).

Your local system administrator can assign a unique IP address for the board, and also provide you the IP addresses of the gateway, netmask, and TFTP server. Fill out the lines below with this information.

Client IP: ____ . ____ . ____ . ____ (IP address of the board)
Server IP: ____ . ____ . ____ . ____ (IP address of the TFTP server)
Gateway: ____ . ____ . ____ . ____ (IP address of the gateway)
Netmask: ____ . ____ . ____ . ____ (Network netmask)

A.2 Configuring dBUG Network Parameters

Freescale Semiconductor, Inc.

Once the network parameters have been obtained, the Rom Monitor must be configured. The following commands are used to configure the network parameters.

```
set client <client IP>
set server <server IP>
set gateway <gateway IP>
set netmask <netmask>
set Macaddr <macaddr>
```

For example, the TFTP server is named 'santafe' and has IP address 123.45.67.1. The board is assigned the IP address of 123.45.68.15. The gateway IP address is 123.45.68.250, and the netmask is 255.255.255.0. The commands to dBUG are:

```
set client 123.45.68.15
set server 123.45.67.1
set gateway 123.45.68.250
set netmask 255.255.255.0
set Macaddr 00:00:00:00:00:00
```

The last step is to inform dBUG of the name and type of the file to download. Prior to giving the name of the file, keep in mind the following.

Most, if not all, TFTP servers will only permit access to files starting at a particular sub-directory. (This is a security feature which prevents reading of arbitrary files by unknown persons.) For example, SunOS uses the directory /tftp_boot as the default TFTP directory. When specifying a filename to a SunOS TFTP server, all filenames are relative to /tftp_boot. As a result, you normally will be required to copy the file to download into the directory used by the TFTP server.

A default filename for network downloads is maintained by dBUG. To change the default filename, use the command:

```
set filename <filename>
```

When using the Ethernet network for download, either S-record, COFF, ELF, or Image files may be downloaded. A default filetype for network downloads is maintained by dBUG as well. To change the default filetype, use the command:

```
set filetype <srecord|coff|elf|image>
```

Freescale Semiconductor, Inc.

Continuing with the above example, the compiler produces an executable COFF file, 'a.out'. This file is copied to the /tftp_boot directory on the server with the command:

```
rcp a.out santafe:/tftp_boot/a.out
```

Change the default filename and filetype with the commands:

```
set filename a.out
set filetype coff
```

Finally perform the network download with the 'dn' command. The network download process uses the configured IP addresses and the default filename and filetype for initiating a TFTP download from the TFTP server.

A.3 Troubleshooting Network Problems

Most problems related to network downloads are a direct result of improper configuration. Verify that all IP addresses configured into dBUG are correct. This is accomplished via the 'show' command.

Using an IP address already assigned to another machine will cause dBUG network download to fail, and probably other severe network problems. Make certain the client IP address is unique for the board.

Check for proper insertion or connection of the network cable. Is status LED indicating that network traffic is present?

Check for proper configuration and operation of the TFTP server. Most Unix workstations can execute a command named 'tftp' which can be used to connect to the TFTP server as well. Is the default TFTP root directory present and readable?

If 'ICMP_DESTINATION_UNREACHABLE' or similar ICMP message appears, then a serious error has occurred. Reset the board, and wait one minute for the TFTP server to time out and terminate any open connections. Verify that the IP addresses for the server and gateway are correct.

APPENDIX B (ColdFire to ISA, IRQ7 and Reset Logic Abel code)

```
module isa2
title 'isa controller'
"Oct 12 '98 version v3 of the 5307
"isa2 device 'ispLSI';
;"*****"
;"This abel file contains the code for a NE2000 compatible ethernet"
;"for the 5307 ColdFire processor as well as reset and IRQ7 (abort)"
;"It was targeted to Lattice ispLSI LV 2032 PLD  "
;"CS: B25D                                     "
;"*****"
;"*****"
;"Declaration Section                          "
;"*****"
;" constants"
    C,P,X,Z,H,L = .C.,.P.,.X.,.Z.,1,0;
;"*****"
DLYIOCHRDY0 node ISTYPE 'reg_d,buffer';
DLYIOCHRDY,ENDIT,END16,END8 node;
STARTISA node ISTYPE 'reg_d,buffer';
SBHE,IOR,IOW,ISAOE node;
DA,DLYDA node ISTYPE 'reg_d,buffer';
ABORTML,DAOE,CLK16MHZ node ISTYPE 'reg_d,buffer';

CLK4MHZ    node ISTYPE 'reg_d,buffer';

RSTMH node;
BCLK0 node ISTYPE 'reg_d,buffer';
BCLK1 node ISTYPE 'reg_d,buffer';
BCLK2 node ISTYPE 'reg_d,buffer';

ABORTOL    pin 3 ISTYPE 'reg_d, buffer';
RST_L      pin 4;                "Output - to ColdFire reset
DB_CS_L    pin 5;                "Output - Data buffer enable for
ethernet
A0IN       pin 6;                "INPUT  - A0 received from CF through buffers
IOCHRDY    pin 7;                "Input  - asserted by ethernet
IOCS16L    pin 9;                "Input  - asserted by ethernet
SIZ1       pin 10;
```

Freescale Semiconductor, Inc.

```
XCLK0          pin 11;          "Input - global clock
IOWL          pin 15;          "Input - write signal from ethernet
RD            pin 16;          "INPUT - R/W* from the ColdFire
CLK8MHZ       pin 17 ISTYPE 'reg_d,buffer';
BALE          pin 18;          "Output - address latch enable
A0            pin 19;          "OUTPUT - A0 sent to the ethernet
PORIN_L       pin 26;          "Input - Suppy Voltage Supervisor
CS3_L         pin 22;          "Input - From ColdFire
RSTIN_L       pin 27;          "Input - Hard Reset switch
ETHER_IRQ     pin 28;          "Input - Ethernet IRQ 3
IRQ3          pin 29;          "Output - IRQ 3 into the ColdFire
RST_H         pin 30;          "Output - to the Ethernet
ABORTIL       pin 31;          "INPUT - abort signal received from the Abor
swith
HIZ_L         pin 32;          "Output - to ColdFire *HIZ
IORL          pin 37;          "Input - read signal from ethernet
A16           pin 39;
TAL           pin 40;          "Input / Output - Transfer acknowledge
SBHEL         pin 41;          "Output - sent to the ethernet
SIZ0          pin 43;
BDM_RST_L     pin 44;          "Input - BDM reset input
```

```
; "*****"
; " Lattice attributes          "
; "*****"
pLSI property 'CLK XCLK0 CLK0 ';
pLSI property 'CLK CLK8MHZ SLOWCLK ';
pLSI property 'ISP ON';
pLSI property 'PULLUP ON';
pLSI property 'Y1_AS_RESET OFF';

; "-----"
; " Output inverter macro      "
; "-----"
OB21 MACRO (X00, A0)
    {
        ?X00 = !?A0;
    };

; "-----"
```

```
; " Tristate Output inverter macro "  
; "-----"  
OT21 MACRO (XO0, A0, OE)  
    {  
        ?XO0.OE = ?OE;  
        ?XO0 = !?A0;  
    };  
  
CBU43 MACRO (Q0,Q1,Q2,CLK,EN,CS)  
{  
    [?Q0..?Q2].clk = ?CLK;  
    ?Q0.D = ?Q0.Q & !?CS $ ?EN & !?CS ;  
    ?Q1.D = ?Q1.Q & !?CS $ ( ?Q0.Q & ?EN & !?CS );  
    ?Q2.D = ?Q2.Q & !?CS $ ( ?Q0.Q & ?Q1.Q & ?EN & !?CS );  
};  
  
equations  
  
;"#####"  
;"Bidirectional circuit equations"  
;"#####"  
  
OT21 (TAL, DA, DAOE)  
OB21 (IORL, IOR)  
OB21 (IOWL, IOW)  
OB21 (RST_L, RST_H)  
  
SBHEL = 1;  
  
IRQ3 = !ETHER_IRQ;  
  
!DB_CS_L = !RST_H & !CS3_L;  
  
ABORTML := ABORTIL ;  
  
ABORTML.clk = CLK8MHZ ;  
  
ABORTOL := ABORTML ;  
  
ABORTOL.clk = CLK8MHZ ;  
  
RSTMH = !RSTIN_L ;
```

```
RST_H = RSTMH # !PORIN_L # !BDM_RST_L;

"!HIZ_L = !RST_L;
HIZ_L = 1;

DAOE := !CS3_L # DA;

DAOE.clk = XCLK0 ;

A0 = !SIZ1 & SIZ0 & !A0IN #
    A16 ;

SBHE = STARTISA & !SIZ1 & SIZ0 & !A0IN #
    STARTISA & SIZ1 & !SIZ0 & !A0IN #
    STARTISA & !SIZ1 & !SIZ0 & !A0IN ;

CLK16MHZ := !CLK16MHZ ;

CLK16MHZ.clk = XCLK0 ;

CLK8MHZ := CLK8MHZ & !CLK16MHZ #
    !CLK8MHZ & CLK16MHZ ;

CLK8MHZ.clk = XCLK0 ;

CLK4MHZ := CLK4MHZ $ ( CLK16MHZ & CLK8MHZ );

CLK4MHZ.clk = XCLK0 ;

DA := !CS3_L & END16 & ENDIT & !IOCS16L & RD & !CLK8MHZ & SBHE #
    !CS3_L & END8 & ENDIT & RD & !CLK8MHZ #
    DLYDA & !CS3_L #
    DA & !CS3_L;

DA.clk=XCLK0;

DLYDA := !CS3_L & END16 & ENDIT & !IOCS16L & !RD & !CLK8MHZ & SBHE #
    !CS3_L & END8 & ENDIT & IOCS16L & !RD & !CLK8MHZ #
    !CS3_L & END8 & ENDIT & !SBHE & !RD & !CLK8MHZ ;
DLYDA.clk=XCLK0;

STARTISA := !CS3_L & !ENDIT ;
```

Freescale Semiconductor, Inc.

```
STARTISA.clk = CLK8MHZ ;

CBU43 (BCLK0,BCLK1,BCLK2,CLK8MHZ,STARTISA,!STARTISA)

BALE = STARTISA & !CLK8MHZ & !BCLK2 & !BCLK1 & !BCLK0 & !IOR & !IOW ;

IOR = STARTISA & !BCLK2 & !BCLK1 & BCLK0 & !CLK8MHZ & RD #
      IOR & !CS3_L ;

IOW = STARTISA & !BCLK2 & !BCLK1 & BCLK0 & !CLK8MHZ & !RD #
      IOW & STARTISA ;

END16 = !BCLK2 & BCLK1 & !BCLK0 & !CLK8MHZ#
        END16 & STARTISA ;

END8 = BCLK2 & !BCLK1 & BCLK0 & !CLK8MHZ #
        END8 & STARTISA ;

ENDIT = END16 & !IOCS16L & IOCHRDY & DLYIOCHRDY0 & DLYIOCHRDY & SBHE &
        STARTISA#
        END8 & IOCS16L & IOCHRDY & DLYIOCHRDY0 & DLYIOCHRDY & STARTISA #
        END8 & !SBHE & IOCHRDY & DLYIOCHRDY0 & DLYIOCHRDY & STARTISA ;

DLYIOCHRDY0:= IOCHRDY;

DLYIOCHRDY0.clk = CLK8MHZ ;

DLYIOCHRDY = IOCHRDY & CLK8MHZ #
            DLYIOCHRDY & !CLK8MHZ ;

; "*****"
;" Test Vector Section"
; "*****"
test_vectors 'HIZ_L Test Vector'
([XCLK0, RSTIN_L, PORIN_L, BDM_RST_L, CS3_L]->[RST_H])
[P,1,1,1,1]->[X];
[C,1,1,1,1]->[X];
[C,1,0,1,1]->[X];
[C,1,0,1,1]->[X];
[C,1,1,1,1]->[X];
[C,1,1,1,1]->[X];
[C,0,1,1,1]->[X];
```

```
[C,0,1,1,1]->[X];  
[C,0,1,1,1]->[X];  
[C,1,1,1,1]->[X];  
[C,1,1,0,1]->[X];  
[C,1,1,1,1]->[X];  
[C,1,1,1,1]->[X];  
[C,1,1,1,1]->[X];  
[C,0,1,1,1]->[X];  
[C,0,1,1,1]->[X];  
[C,0,1,1,1]->[X];  
[C,0,1,1,0]->[X];  
[C,0,1,1,0]->[X];  
[C,0,1,1,0]->[X];  
[C,0,1,1,1]->[X];  
[C,0,1,1,1]->[X];  
[C,0,1,1,1]->[X];  
[C,1,1,1,1]->[X];  
[C,1,1,1,1]->[X];  
[C,1,1,1,0]->[X];  
[C,1,1,1,0]->[X];  
[C,1,1,0,0]->[X];  
[C,1,1,1,1]->[X];  
[C,1,1,1,1]->[X];  
[C,1,1,1,1]->[X];  
end
```

Freescale Semiconductor, Inc.

APPENDIX (Schematics)

Freescale Semiconductor, Inc.

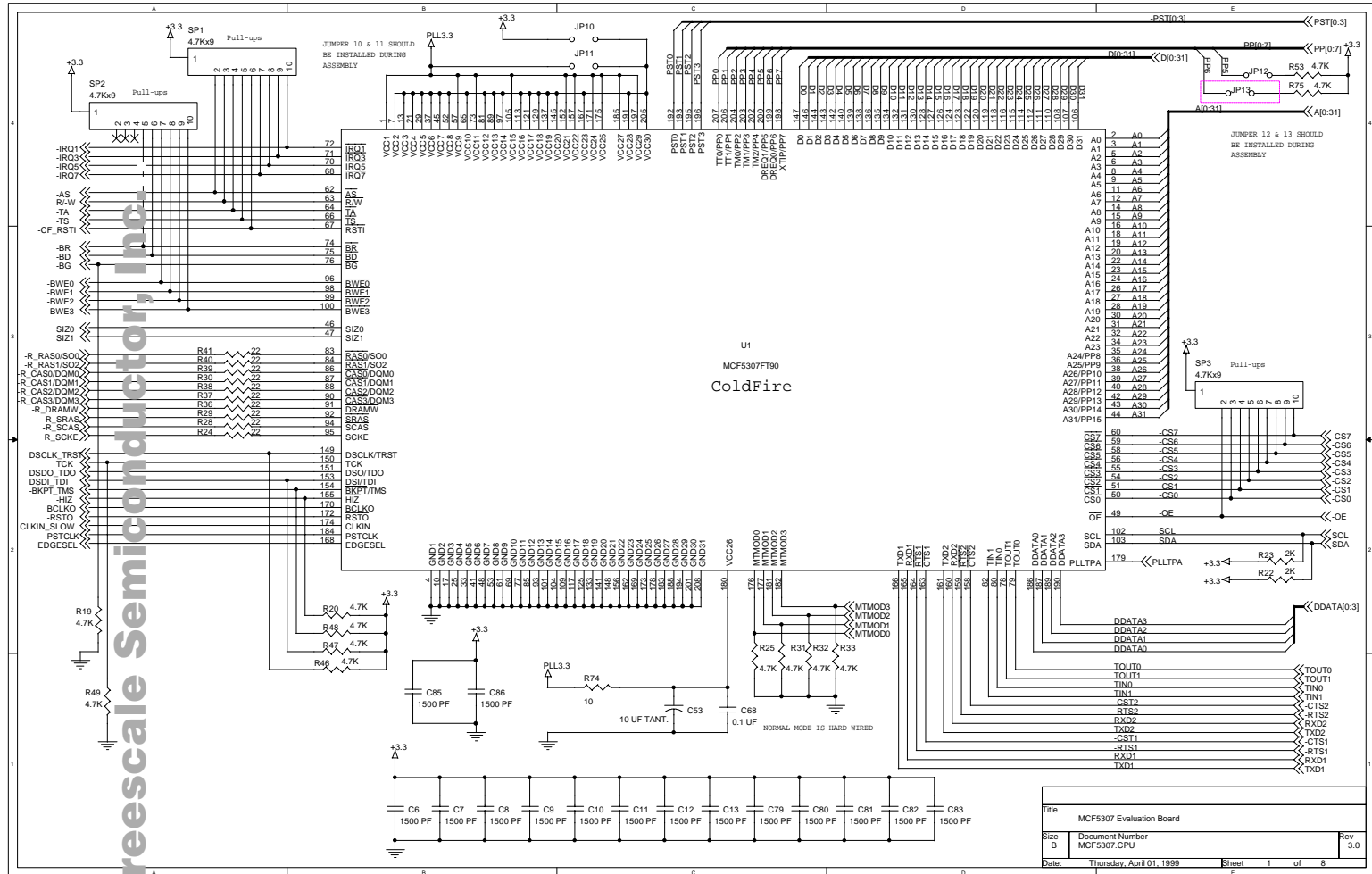

Freescale Semiconductor, Inc.

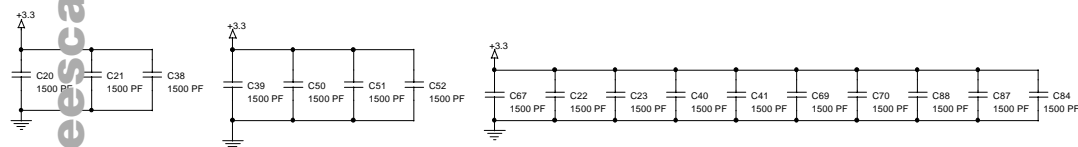
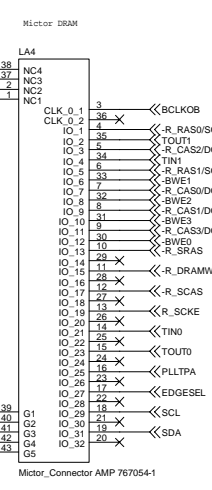
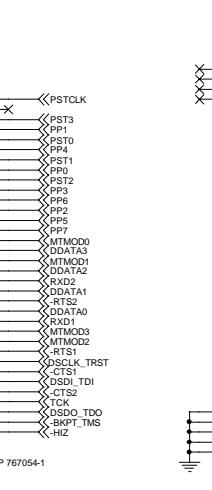
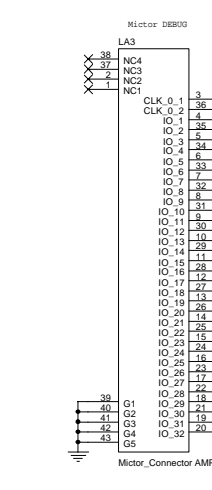
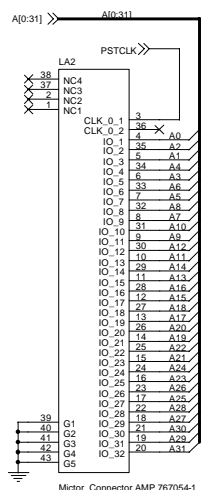
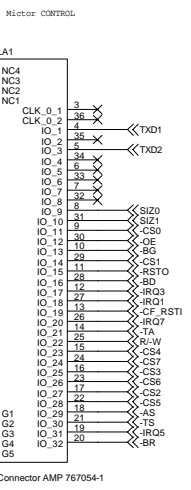

Title			MCF5307 Evaluation Board
Size	Document Number		Rev
B	MCF5307.CONNECTORS		3.0
Date:	Thursday, April 01, 1999	Sheet	2 of 8

Freescale Semiconductor, Inc.

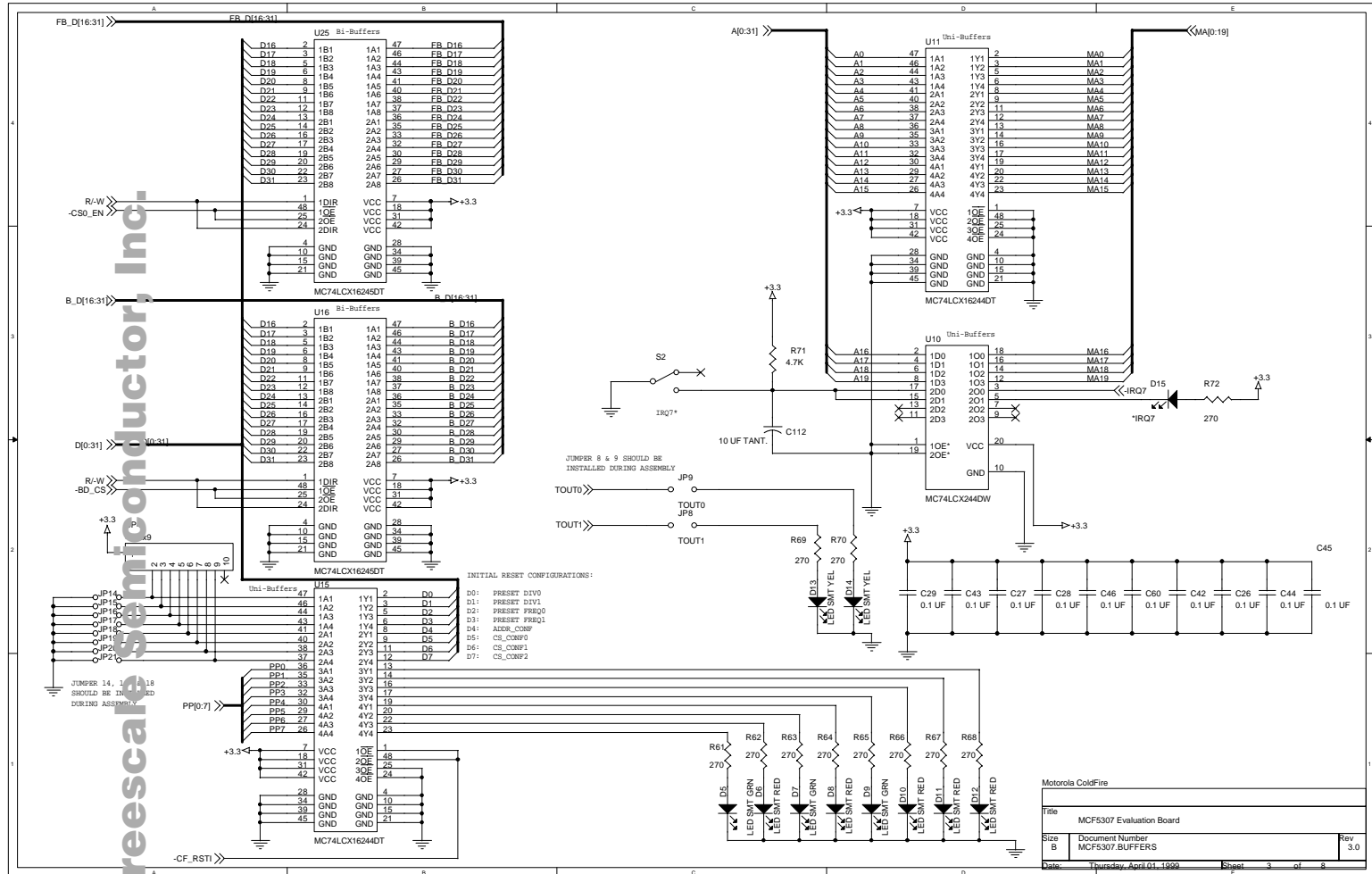

Motorola ColdFire		
Title: MCF5307 Evaluation Board		
Size: B	Document Number: MCF5307.BUFFERS	Rev: 3.0
Date: Thursday, April 01, 1999	Sheet: 3	of: 8

Freescale Semiconductor Inc.

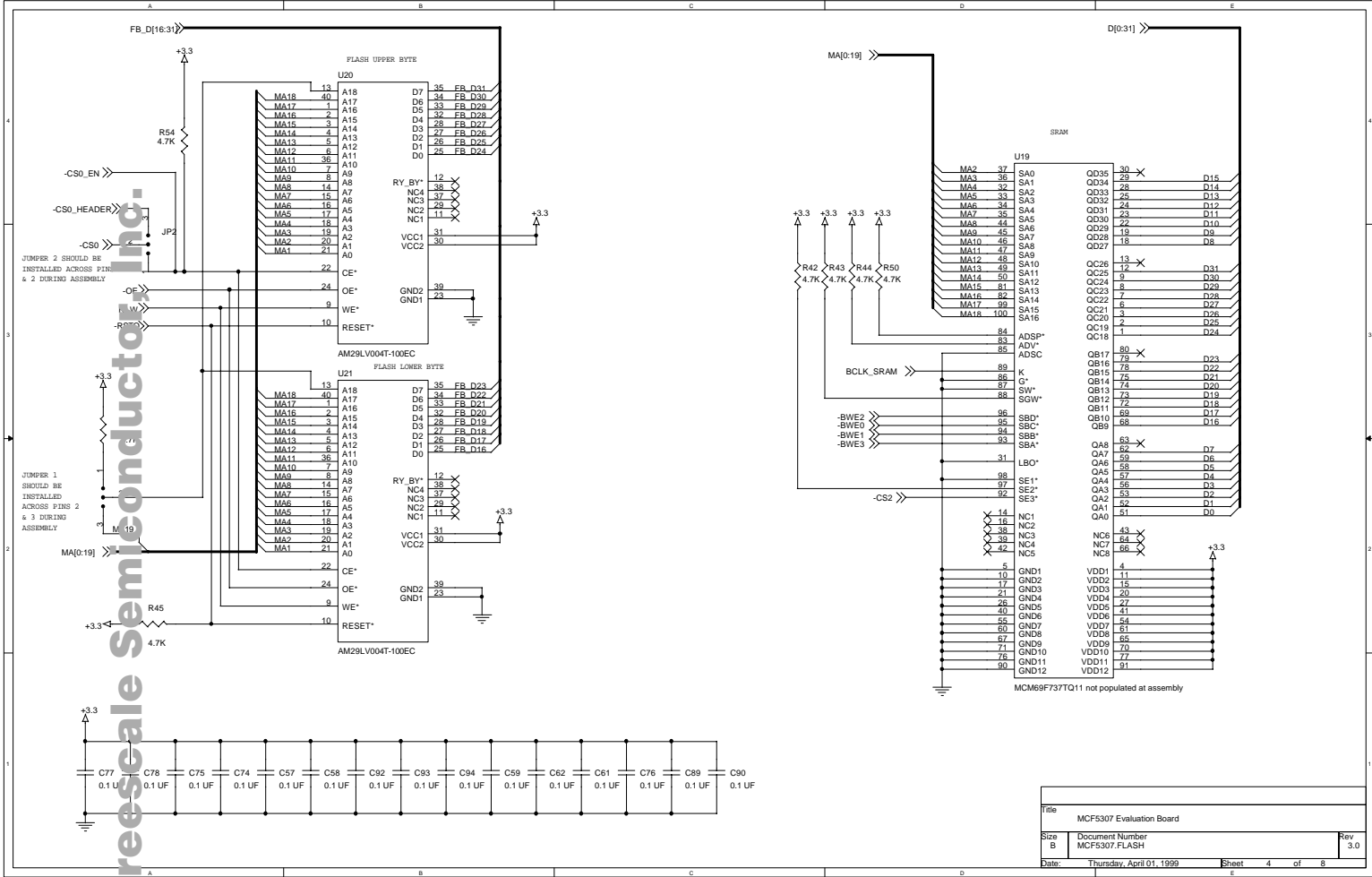

Title			MCF5307 Evaluation Board
Size	Document Number		Rev
B	MCF5307_FLASH		3.0
Date:	Thursday, April 01, 1999	Sheet	4 of 8

Freescale Semiconductor, Inc.

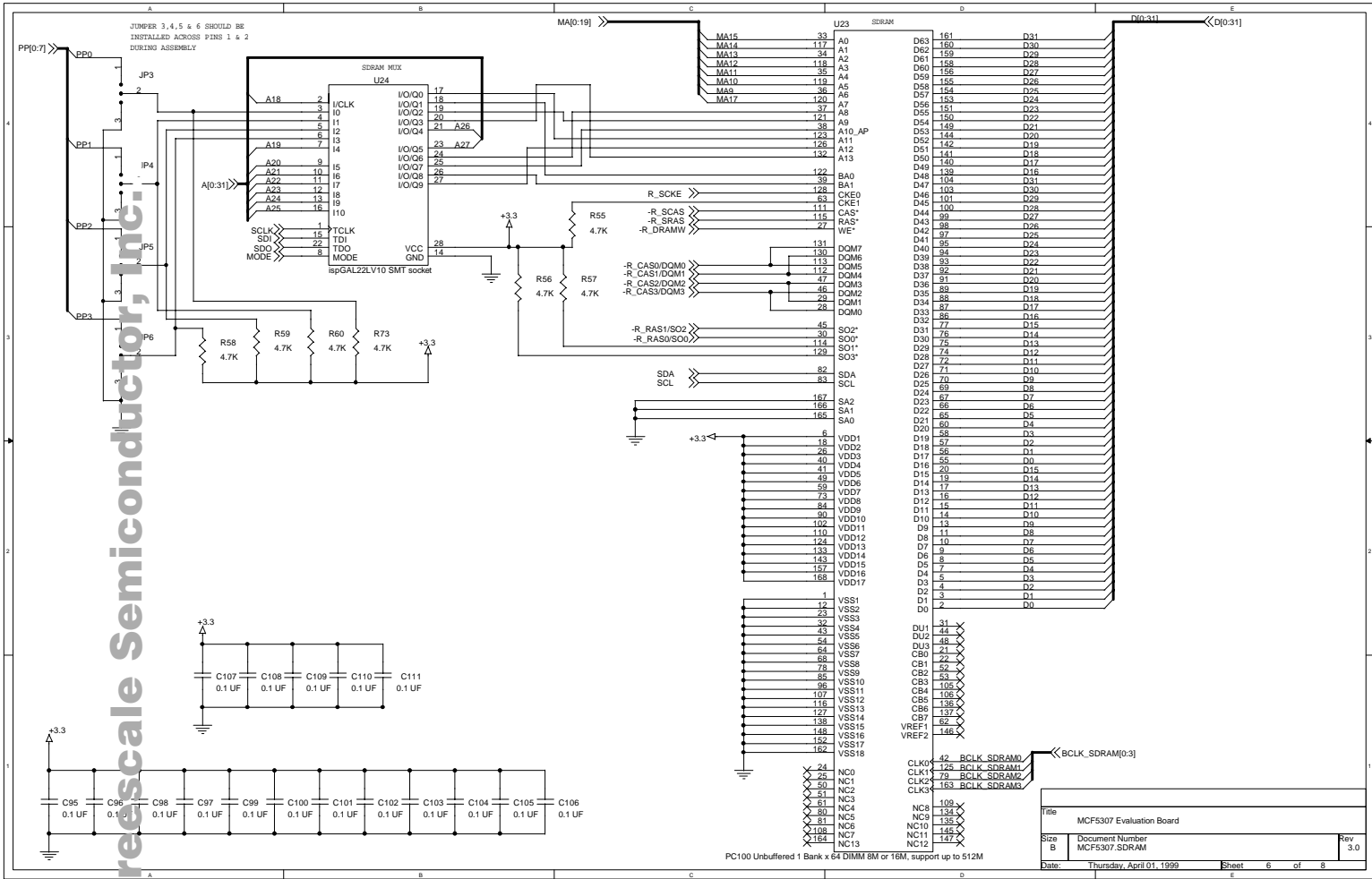

Freescale Semiconductor, Inc.

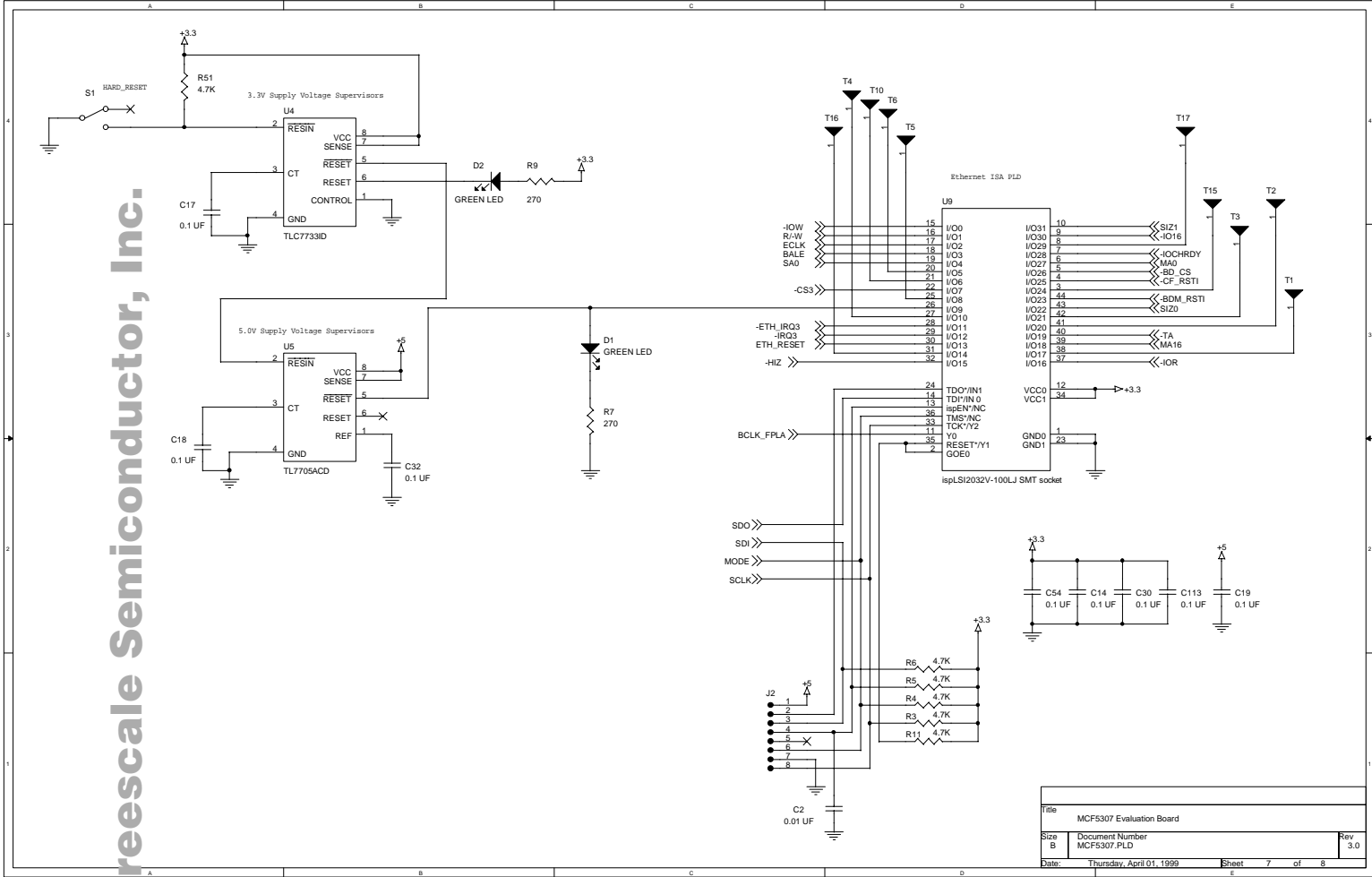

Title			MCF5307 Evaluation Board
Size	Document Number	Rev	
B	MCF5307.PLD	3.0	
Date:	Thursday, April 01, 1999	Sheet	7 of 8

Freescale Semiconductor, Inc.

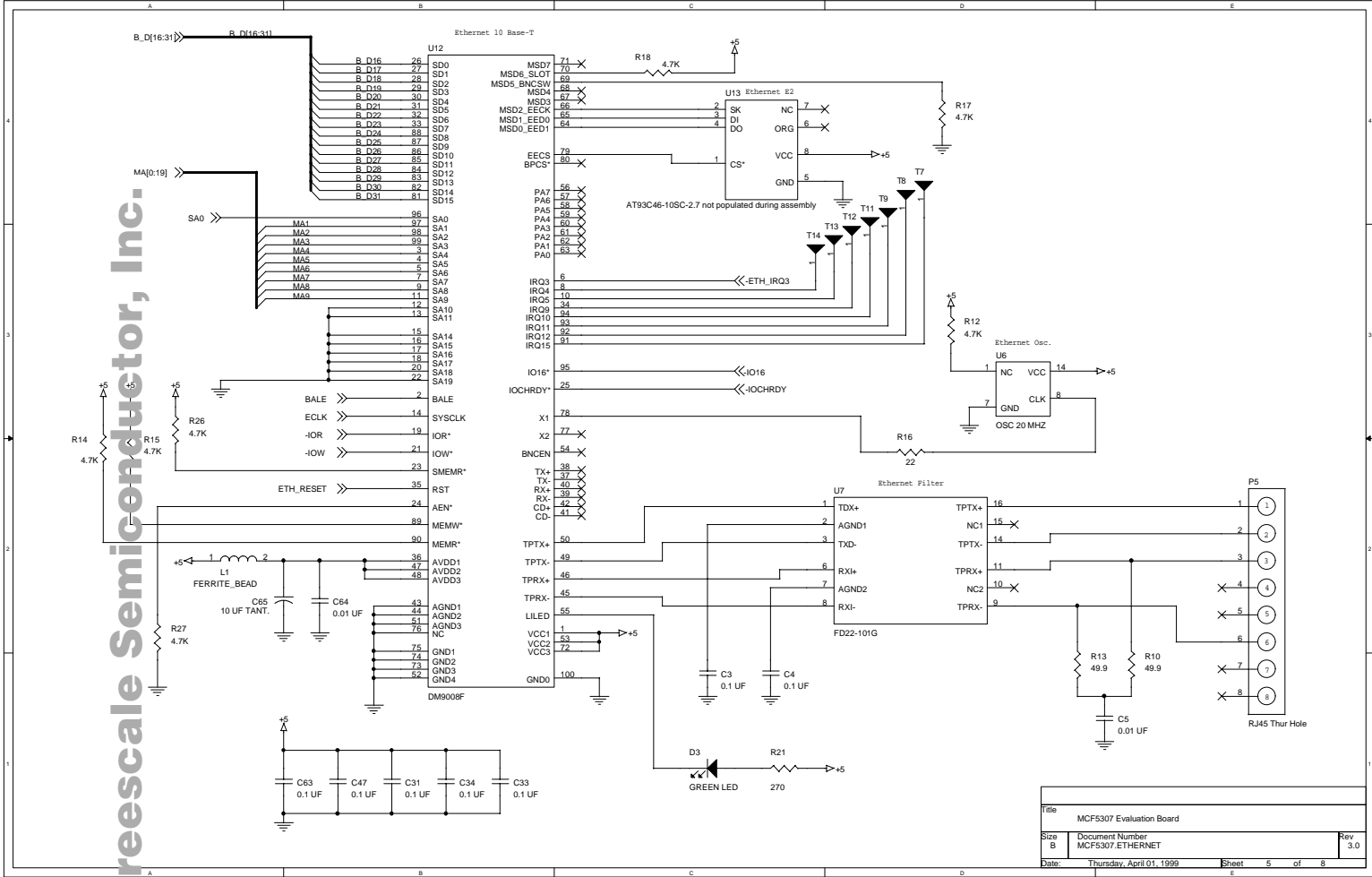

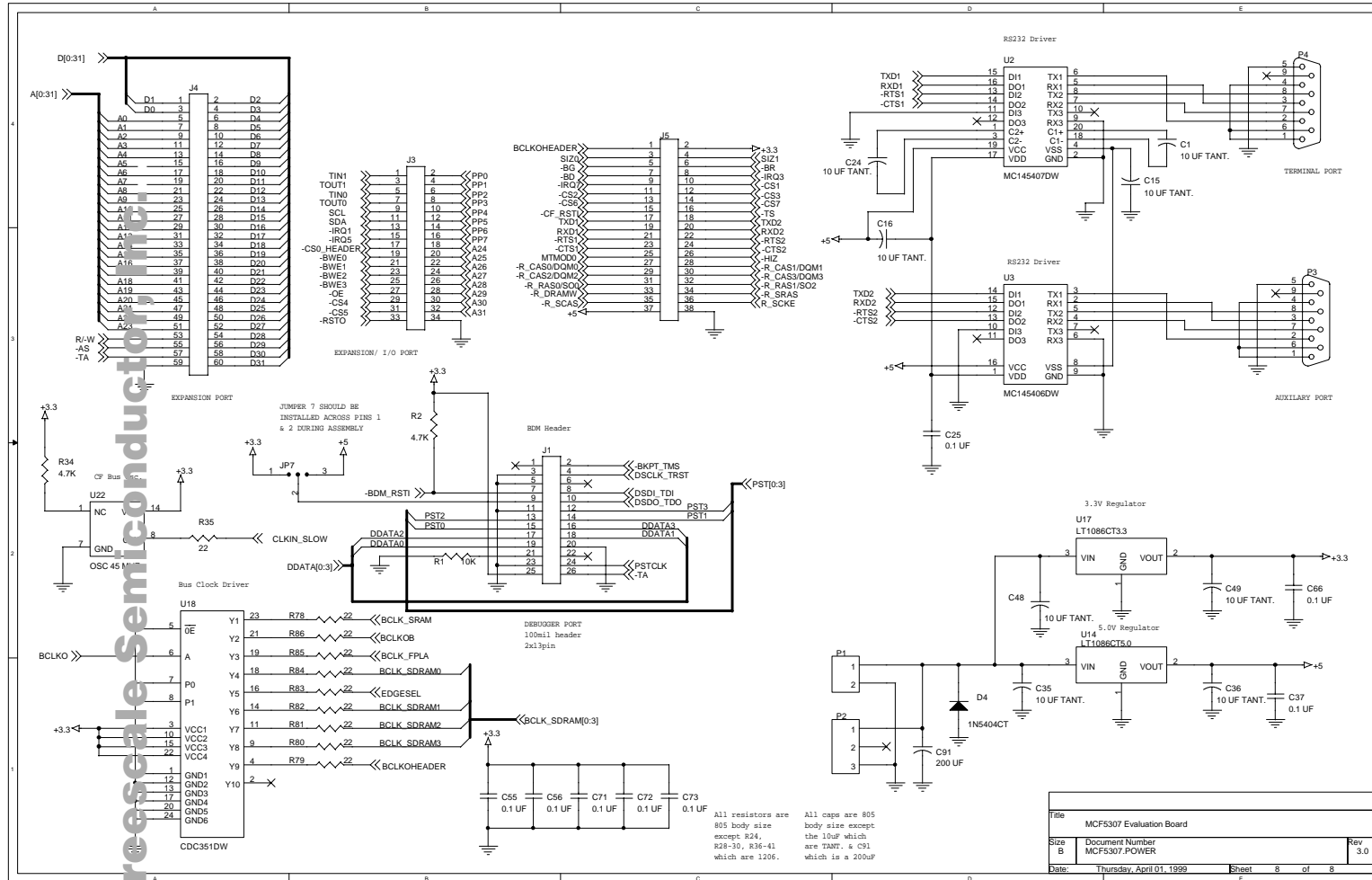

All resistors are 805 body size except R24, R28-30, R36-41 which are 1206.

All caps are 805 body size except the 1uF which are TANT. & C91 which is a 200uF

Title			MCF5307 Evaluation Board
Size	Document Number	Rev	
B	MCF5307.POWER	3.0	
Date:	Thursday, April 01, 1999	Sheet	8 of 8

APPENDIX D SDRAM MUX PAL EQUATION

```

module SDRAMmux
title 'SDRAM Mux Controller for the MCF5307EVM'
"MAR 16 '99 First revision of the code based on Bill Benners application no
"5307mux device 'ispLSI22LV10';
; "*****"
;"This abel file contains the code to mux the address lines"
;"allowing the MCF5307 to support all 168pin 1Bank x 64 bit PC compliant
DIMMS"
;"It was targeted to Lattice ispLSI 22LV10 PAL "
;"All logic with this PAL is com
;"CS:4C86 "
; "*****"
; "*****"
;"Declaration Section "
; "*****"
;" constants"
    C,P,X,Z,H,L = .C.,.P.,.X.,.Z.,1,0;
; "*****"

```

```

M0 PIN 3; "Mux Input (0)
M1 PIN 4; "Mux Input (1)
M2 PIN 5; "Mux Input (2)
M3 PIN 6; "Mux Input (3)
CA18 PIN 2; "Input - ColdFire driven address (18)
CA19 PIN 7; "Input - ColdFire driven address (19)
CA20 PIN 9; "Input - ColdFire driven address (20)
CA21 PIN 10; "Input - ColdFire driven address (21)
CA22 PIN 11; "Input - ColdFire driven address (22)
CA23 PIN 12; "Input - ColdFire driven address (23)
CA24 PIN 13; "Input - ColdFire driven address (24)
CA25 PIN 16; "Input - ColdFire driven address (25)
CA26 PIN 23; "Input - ColdFire driven address (26)
CA27 PIN 21; "Input - ColdFire driven address (27)
SA8 PIN 24; "Output - SDRAM input address (A8)
SA9 PIN 19; "Output - SDRAM input address (A9)
SA10 PIN 25; "Output - SDRAM input address (A10)
SA11 PIN 17; "Output - SDRAM input address (A11)
SA12 PIN 27; "Output - SDRAM input address (A12)

```

Freescale Semiconductor, Inc.

```
SA13 PIN 20;          "Output - SDRAM input address (A13)
BA0  PIN 18;          "Output - SDRAM input address (BA0)
BA1  PIN 26;          "Output - SDRAM input address (BA1)
select    = [M3,M2,M1,M0];
```

```
; "*****"
; " Lattice attributes          "
; "*****"
"pLSI property 'CLK XCLK0 CLK0 ' ;
"pLSI property 'CLK CLK8MHZ SLOWCLK ' ;
pLSI property 'ISP ON' ;
pLSI property 'PULLUP ON' ;
pLSI property 'Y1_AS_RESET OFF' ;
```

equations

```
;"#####"
;"COMBINATORIAL Logic Only"
;"#####"
```

```
when (select == 0) then {SA8=CA18;
                          SA9=CA19;
                          SA10=CA20;
                          BA0=CA21;
                          BA1=CA22;
                          }
```

```
when (select == 1) then {SA8=CA19;
                          SA9=CA20;
                          SA10=CA21;
                          BA0=CA22;
                          BA1=CA23;
                          }
```

```
when (select == 2) then {SA8=CA19;
                          SA9=CA21;
                          SA10=CA22;
                          BA0=CA23;
                          BA1=CA24;
                          }
```

```
when (select == 3) then {SA8=CA18;  
    SA9=CA19;  
    SA10=CA20;  
    SA11=CA21;  
    BA0=CA22;  
    BA1=CA23;  
}
```

```
when (select == 4) then {  
    SA8=CA19;  
    SA9=CA20;  
    SA10=CA21;  
    SA11=CA22;  
    BA0=CA23;  
    BA1=CA24;  
}
```

```
when (select == 5) then {  
    SA8=CA19;  
    SA9=CA21;  
    SA10=CA22;  
    SA11=CA23;  
    BA0=CA24;  
    BA1=CA25;  
}
```

```
when (select == 6) then {  
    SA8=CA19;  
    SA9=CA21;  
    SA10=CA23;  
    SA11=CA24;  
    BA0=CA25;  
    BA1=CA26;  
}
```

```
when (select == 7) then {SA8=CA18;  
    SA9=CA19;  
    SA10=CA20;  
    SA11=CA21;  
    SA12=CA22;  
    BA0=CA23;  
    BA1=CA24;  
}
```

```

when (select == 8) then {SA8=CA19;
    SA9=CA20;
    SA10=CA21;
    SA11=CA22;
    SA12=CA23;
    BA0=CA24;
    BA1=CA25;
}

```

```

when (select == 9) then {SA8=CA19;
    SA9=CA21;
    SA10=CA22;
    SA11=CA23;
    SA12=CA24;
    BA0=CA25;
    BA1=CA26;
}

```

```

when (select == ^h0A) then { SA8=CA19;
    SA9=CA21;
    SA10=CA23;
    SA11=CA24;
    SA12=CA25;
    BA0=CA26;
    BA1=CA27;
}

```

" Test Vector Section"

```

test_vectors 'M0, M1, M2, M3 Test Vector'
([M3, M2, M1, M0, CA18, CA19, CA20, CA21, CA22, CA23, CA24, CA25, CA26, CA27,
>[SA8, SA9, SA10, SA11, SA12, BA0, BA1])
[0,0,0,0,1,0,1,0,1,0,1,0,1,0]->[X,X,X,X,X,X,X];
[0,0,0,1,1,0,1,0,1,0,1,0,1,0]->[X,X,X,X,X,X,X];
[0,0,1,0,1,0,1,0,1,0,1,0,1,0]->[X,X,X,X,X,X,X];
[0,0,1,1,1,0,1,0,1,0,1,0,1,0]->[X,X,X,X,X,X,X];
[0,1,0,0,1,0,1,0,1,0,1,0,1,0]->[X,X,X,X,X,X,X];
[0,1,0,1,1,0,1,0,1,0,1,0,1,0]->[X,X,X,X,X,X,X];
[0,1,1,0,1,0,1,0,1,0,1,0,1,0]->[X,X,X,X,X,X,X];
[0,1,1,1,1,0,1,0,1,0,1,0,1,0]->[X,X,X,X,X,X,X];

```

Freescale Semiconductor, Inc.

[1,0,0,0,1,0,1,0,1,0,1,0,1,0]->[X,X,X,X,X,X,X];

[1,0,0,1,1,0,1,0,1,0,1,0,1,0]->[X,X,X,X,X,X,X];

end

Freescale Semiconductor, Inc.

AN1802/D
(Motorola Order Number)

5/1999
REV. 0.1



Application Note
**Connecting the MCF5307 to 168-Pin
Unbuffered SDRAM DIMMs**

*William R. Benner, Jr.
Pangolin Laser Systems
William_Benner@msn.com*

*68K/ColdFire Applications Team
Motorola, Inc.
imaging@oakhill.sps.mot.com*

A special note of appreciation goes to William Benner, Jr. of Pangolin Laser Systems, the primary author of this application note. Mr. Benner is gracious enough to allow Motorola to share his experience and knowledge with other customers.

This application note shows how to interchange various standard synchronous DRAM (SDRAM) dual-inline memory modules (DIMMs) in a ColdFire[®] MCF5307 design without re-routing the board. The MCF5307 integrates a Version 3 core with an 8-KByte unified cache, 4-KByte SRAM, an asynchronous/synchronous DRAM controller, and various other popular embedded peripherals. For further details on the MCF5307, refer to the MCF5307 Product Brief (MCF5307/D).

1.1 Introduction

As the demand for lower-cost, higher-performance embedded products increase, designers are discovering new techniques for lowering the price and complexity of their embedded board platforms. By integrating inexpensive, fast SDRAM devices on board designs, many embedded board manufacturers are realizing lower board costs. Due to their large volume

This document contains information on a new product under development by Motorola. Motorola reserves the right to change or discontinue this product without notice.
© Motorola, Inc., 1999. All rights reserved.



use in standard PCs, SDRAM devices are currently the least expensive memory available, in addition to being one of the fastest memory types. These devices normally come packaged in handy, upgradable modules called DIMMs, which contain several SDRAM components on one or both sides of the memory card.

Using the SDRAM controller, the MCF5307 can seamlessly interface to standard SDRAM components and DIMMs. Although the number of row, column, and bank select lines can vary from module to module, the multiplexing scheme in the MCF5307 is designed to support a large variety of SDRAM configurations. To extend this MCF5307 feature further, a PLD can be designed to interface to the MCF5307 SDRAM controller that allows the connection of a wide variety of SDRAM DIMMs having different row and column configurations. Thus, rather than hardwiring one specific SDRAM DIMM to a MCF5307 board design, SDRAM DIMMs with varying row and column combinations can be swapped without re-design.

This document details a method of connecting the MCF5307 to single-sided DIMMs with 8, 9, 10, or 11 column address lines, 11, 12, or 13 row address lines, and up to 2 bank address lines using a PLD design. This design can support up to 512 MBytes of memory, which is compatible with the MCF5307's addressing capability.

1.1.1 Definitions

Before the PLD design is presented, it is helpful to review some of the terminology that will be used in this document:

- MCF5307 Memory Bank—This refers to any group of memories that are selected by one of the MCF5307 RAS[1:0] signals. Thus, the MCF5307 can support two SDRAM banks. Note that the RAS[1:0] signals interface to the chip-select signals (\overline{CS}) on SDRAMs.
- SDRAM Bank—This term is often used by SDRAM manufacturers to distinguish between the internal partitions, or banks, in a single SDRAM device. For example, one SDRAM component can have four internal SDRAM banks (that is, a 64-Mbit SDRAM is configured as 512K x 32 x 4 banks) Bank selection is controlled through the bank select pins on the SDRAM.
- SDRAM—Synchronous dynamic random access memory. These operate similar to asynchronous DRAMs (ADRAMs) with the advantage of a synchronous clock, a pipelined multibank architecture, and faster speed. These memories also maintain high memory density.
- DIMM—Dual inline memory module. DIMMs contain rows of SDRAM components on one or both sides of the memory card. This is not to be confused with the SDRAM row address lines, called \overline{SRAS} signals. Note that in this application note all DIMMs mentioned in the design will be single-sided, since single-sided DIMMs contain two \overline{CS} lines (in other words, two MCF5307 banks) that the MCF5307 can support. Double-sided DIMMs generally have four \overline{CS} lines—two on one side of the memory card and two on the other. Because double-sided modules present greater load to the address and data lines of a processor, use of single-sided modules are preferred. Table 1 shows a fairly complete list of the extensive DIMM configurations, along with their associated parameters. Note that modules can have the same capacity, but have different number of bank select lines, row and column address lines, depending on their organization.

Table 1. Example SDRAM DIMMs

Capacity	# of Chips	Chip Organization	Chip Density	Row/Column/Bank Select Address Lines
8 MBytes	4	1 Mbits X 16	16 Mbits	11 rows/8 columns/1 bank select ¹
16 MBytes	8	2 Mbits X 8	16 Mbits	11 rows/9 columns/1 bank select ¹
32 MBytes ²	16	4 Mbits X 4	16 Mbits	11 rows/10 columns/1 bank select ¹
16 MBytes	2	2 Mbits X 32	64 Mbits	11 rows/8 columns/2 bank select ³
32 MBytes	4	4 Mbits X 16	64 Mbits	12 rows ² /8 columns/2 bank select ³
64 MBytes	8	8 Mbits X 8	64 Mbits	12 rows/9 columns/2 bank select ³
128 MBytes ²	16	16 Mbits X 4	64 Mbits	12 rows/10 columns/2 bank select ³
32 MBytes	2	4 Mbits X 32	128 Mbits	12 rows/8 columns/2 bank select ³
64 MBytes	4	8 Mbits X 16	128 Mbits	12 rows/9 columns/2 bank select ³
128 MBytes	8	16 Mbits X 8	128 Mbits	12 rows/10 columns/2 bank select ³
256 MBytes ²	16	32 Mbits X 4	128 Mbits	12 rows/11 columns/2 bank select ³
64 MBytes	2	8 Mbits X 32	256 Mbits	13 rows/8 columns/2 bank select ³
128 MBytes	4	16 Mbits X 16	256 Mbits	13 rows/9 columns/2 bank select ³
256 MBytes	8	32 Mbits X 8	256 Mbits	13 rows/10 columns/2 bank select ³
512 MBytes ²	16	64 Mbits X 4	256 Mbits	13 rows/11 columns/2 bank select ³

¹ One bank select line selects between two banks within the SDRAM component.

² Denotes a double-sided module. The memory from only one side can be used due to the SDRAM controller only supporting two \overline{CS} signals.

³ Two bank select lines select between four banks within the SDRAM component.

1.2 Hardware Configuration

Unlike ADRAM memory, SDRAM does not use a symmetrical multiplexed addressing scheme, one in which each address line on the DRAM device connects to two internal address lines—a row and column address. ADRAM memories interfacing to the MCF5307 can use a simple wiring scheme in which a single wire is added each time an ADRAM address bus grows by one bit, corresponding to one row address and one column address. With SDRAM, however, the lower 8 (or 9 or 10 or 11) address lines typically do connect internally to both row and column address lines, but higher address lines do not connect to column address lines. This is illustrated in Table 1, where the 8 MByte module has 8 column address lines, but 11 row address lines.

The MCF5307 SDRAM controller was designed to interface to these asymmetrical SDRAMs seamlessly. Standard SDRAM component can be directly connected to the MCF5307 by following the easy connection chart found in the Asynchronous/Synchronous Operation Section of the MCF5307 User's Manual. Because the MCF5307 SDRAM controller can be continually re-programmed to support various SDRAM configurations, this advantage can be leveraged to create a helper MUX that can support swapping of these various SDRAMs in hardware.

Because different density SDRAM devices have different asymmetries, a single direct connection scheme is not possible. An easy connection scheme for each specific module type can be derived by referring to Table 1 and the MCF5307 address multiplexing scheme in the asynchronous operation section of the MCF5307 User's Manual. Since there is some commonality with respect to the connection scheme of each module type, an in-between helper MUX can be conceived that interfaces between the MCF5307 and SDRAM DIMM.

Table 2 and Table 3 depict the MCF5307 SDRAM controller to SDRAM connections¹ necessary for different SDRAMs. Table 2 lists the address line connections for various SDRAMs while Table 3 lists the required bank select interface.

Table 2. SDRAM Address Line Connections

CF Address	Condition	SDRAM Address	Column Address	Row Address
A15	Always	A0	A2	A15
A14	Always	A1	A3	A14
A13	Always	A2	A4	A13
A12	Always	A3	A5	A12
A11	Always	A4	A6	A11
A10	Always	A5	A7	A10
A9	Always	A6	A8	A9
A17	Always	A7	A16	A17
A18	8 columns	A8	N/A ¹	A18
A19	9, 10, or 11 columns		A18	A19
A19	8 columns	A9	N/A	A19
A20	9 columns		N/A	A20
A21	10 or 11 columns		A20	A21
A20	8 columns	A10	N/A	A20
A21	9 columns		N/A	A21
A22	10 columns		N/A	A22
A23	11 columns		A22	A23
A21	8 columns	A11	N/A	A21
A22	9 columns		N/A	A22
A23	10 columns		N/A	A23
A24	11 columns		N/A	A24

¹Note that although the data bus and other control connections to SDRAM are not necessary to these discussions or detailed in these tables, information on these hardware hookups can be found in the LAB5307 or SBC5307 schematics and the MCF5307 User's Manual at <http://www.mot.com/ColdFire>.

Table 2. SDRAM Address Line Connections (Continued)

CF Address	Condition	SDRAM Address	Column Address	Row Address
A22	8 columns	A12	N/A	A22
A23	9 columns		N/A	A23
A24	10 columns		N/A	A24
A25	11 columns		N/A	A25
A23	8 columns	A13	N/A	A23
A24	9 columns		N/A	A24
A25	10 columns		N/A	A25
A26	11 columns		N/A	A26

¹ Note: N/A indicates that although a ColdFire address will be multiplexed during the column phase, this does not matter because the number of column lines on the device is satisfied by lower address lines. For example, if an 8 column SDRAM is used, the 8 column lines are satisfied by ColdFire address lines A9–A15 and A17. See the table above.

Table 3. SDRAM Bank-Select Line Connections

CF Address	Condition	SDRAM Bank Select
A21	8 columns, 11 rows (19 address lines)	BA0
A22	9 columns, 11 rows (20 address lines) 8 columns, 12 rows	
A23	10 columns, 11 rows 9 columns, 12 rows (21 address lines) 8 columns, 13 rows	
A24	10 columns, 12 rows (22 address lines) 9 columns, 13 rows	
A25	11 columns, 12 rows (23 address lines) 10 columns, 13 rows	
A26	11 columns, 13 rows (24 address lines)	
A22	8 columns, 11 rows (19 address lines)	BA1
A23	9 columns, 11 rows (20 address lines) 8 columns, 12 rows	
A24	10 columns, 11 rows 9 columns, 12 rows (21 address lines) 8 columns, 13 rows	
A25	10 columns, 12 rows (22 address lines) 9 columns, 13 rows	
A26	11 columns, 12 rows (23 address lines) 10 columns, 13 rows	
A27	11 columns, 13 rows (24 address lines)	

An example of a 2 Mbit x 32-bit x 4 bank (8 MByte) SDRAM using Table 2 and Table 3 is shown in Table 4 .

Table 4. 2-Mbit x 32-bit x 4 bank SDRAM Connection to MCF5307

MCF5307 Pins	SDRAM Pins
A15	A0
A14	A1
A13	A2
A12	A3
A11	A4
A10	A5
A9	A6
A17	A7
A18	A8
A19	A9
A20	A10
A21	BA0
A22	BA1

1.2.1 Helper MUX Design

By organizing the MCF5307 SDRAM controller hardware connection information in Table 2 and Table 3, the configuration of the helper MUX inputs/outputs and multiplex selects can be devised. One possible pin configuration for interfacing to a standard 168-pin unbuffered SDRAM DIMM is shown in Figure 1, however this same concept can be carried over to other PLD and pin configurations. This MUX configuration is implemented in a single PLD device that has a low cost and profile, minimal propagation delay, and matches the drive capability of the MCF5307. This example uses a 3.3-volt Lattice ispGAL22LV10K, which has almost identical output characteristics to the MCF5307 and only presents a 5 nS max. propagation delay. This PLD also is available in an SSOP package.

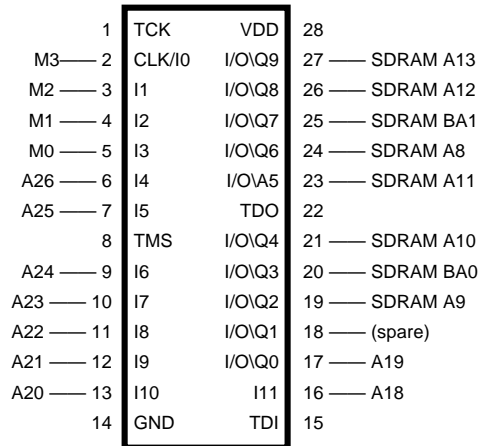

Figure 1. Pin Configuration for ispGAL22LV10K Interface to Standard 168-pin SDRAM DIMM

The M[3:0] lines represent the MUX select configuration mapped from Table 2 and Table 3. A recommended encoding of M[3:0] is shown in Table 5. These signals can be driven by spare parallel port lines on the MCF5307.

Table 5. MUX Select M[3:0] Encoding

M[3:0] MUX Inputs	Corresponding Configuration
0000	8 columns, 11 rows == 8 MBytes (16 Mbit) or 16 MBytes (64 Mbits)
0001	9 columns, 11 rows == 16 MBytes (16 Mbits or 64 Mbits)
0010	10 columns, 11 rows == 32 MBytes (16 Mbits or 64 Mbits)
0011	8 columns, 12 rows == 16 MBytes (64 Mbits) or 32 MBytes (64 Mbits or 128 Mbits)
0100	9 columns, 12 rows == 64 MBytes (64 Mbits or 128 Mbits)
0101	10 columns, 12 rows == 128 MBytes (64 Mbits or 128 Mbits)
0110	11 columns, 12 rows == 256 MBytes (128 Mbits double sided)
0111	8 columns, 13 rows == 32 MBytes (64 Mbits) or 64 MBytes (256 Mbits)
1000	9 columns, 13 rows == 64 MBytes (64 Mbits) or 128 MBytes (256 Mbits)
1001	10 columns, 13 rows == 128 MBytes (64 Mbits) or 256 MBytes (256 Mbits)
1010	11 columns, 13 rows == 512 MBytes (256 Mbits double sided)
1011–1111	Reserved

1.2.2 Helper MUX Implementation

An in-system programmable device was chosen for the helper MUX implementation because it can easily be reconfigured while on the board. The ispGAL22v10 has a 500 gate density, which easily fits the required logic for the helper MUX. Using Lattice Semiconductor's freeware package "ispEXPERT™ System Starter Kit," the ispGAL was programmed in ABEL-HDL. For more information on obtaining the starter kit please refer to <http://www.lattice.com/ftp/ispstarter.html>.

Both the ABEL-HDL and PLD equation files for the helper MUX pictured in Figure 1 can be found at the end of this application note in section 1.6 on page 11 and section 1.7 on page 16.

1.2.3 Helper MUX Initialization

Once implemented in a system, the helper MUX in Figure 1 can be used to interface to various 168-pin SDRAM DIMMs by initializing the MUX select pins M[3:0] to the proper SDRAM configuration. SDRAM configuration information can be read at boot time through a serial presence detect (SPD) EEPROM on the SDRAM DIMM. This EEPROM contains data about the number of rows, columns, banks, access times, etc. of the DIMM. The SPD portion of this module is accessed on pins 82 and 83 of a 168-pin DIMM and can be connected to the SDA and SCL pins of the MCF5307, respectively. Information can be read from the SPD by using these I²C pins on the MCF5307 to determine the configuration of the memory. This information should be read at boot time and it should be used to initialize the M[3:0] lines on the helper PLD, as well as the internal MCF5307 SDRAM configuration registers. Information on the MCF5307 SDRAM Controller initialization sequence can be found in the Motorola application note AN1766/D. The specification for the Intel® PC100 can be found at <http://developer.intel.com/design/chipsets/memory/sdram.htm>.

1.3 System Design

Besides interfacing the helper MUX to the MCF5307, other board design requirements must be met to allow for the swapping of various DIMMs.

One consideration is the number of clock inputs. Some 168-pin SDRAM DIMMs only require a single clock input on CLK0 (pin 42). Other DIMMs require two clocks on either CLK0 (pin 42) and CLK1 (pin 125) or on CLK0 (pin 42) and CLK2 (pin 79). Yet others require four clocks; CLK0 (pin 42), CLK1 (pin 125), CLK2 (pin 79), and CLK3 (pin 163). Thus, a clock driver with at least four outputs is recommended in the board design to satisfy the requirements of a four-clock input DIMM. DIMMs have on-board termination for unused clock inputs. Use of zero-delay PLL-type clock driver, such as the Cypress Semiconductor CY2305, CY2308, or CY2309 is highly recommended.

The next consideration is the connection to the DIMM chip-select lines that control the module. For single-sided or double-sided 168-pin DIMMs, the MCF5307 $\overline{\text{RAS0}}$ should be connected to $\overline{\text{CS0}}$ (pin 30) of the module and $\overline{\text{RAS1}}$ should be connected to $\overline{\text{CS2}}$ (pin 45) of the module. The remaining module chip-select lines— $\overline{\text{CS1}}$ (pin 114) and $\overline{\text{CS3}}$ (pin 129) should be connected to the 3.3-volt DIMM power-supply through pull-up resistors. This ensures that chips on the back side of double-sided modules remain deselected (i.e., inactive) and prevents any possible contention on the data bus.

Because the back side of the DIMM is not being used in this design, its clock select line should also be disabled. A 168-pin DIMM has two clock enable lines for each side of the DIMM, CKE0 (pin 128) and CKE1 (pin 63), which activate a low-power/self-refresh mode of an SDRAM. It is recommended that the CKE1 control line be left floating, while the CKE0 pin is connected to the SCKE pin of the MCF5307. The CKE1 line controls the clock select line on the back side of DIMMs, and has a 10 K Ohm pull-up resistor on the module itself.

1.4 Timing Analysis

To ensure the helper MUX did not interfere with the timing requirements of a standard SDRAM, a timing analysis was done based on the following design assumptions:

- BCLKO frequency—45 MHz (22 nS period) BCLKO/ 90 MHz core clock
- Clock Driver Delay—0 nS
- EDGESEL Connection—Tied high through a pull-up
- Data Bus Connection—Connected directly to the SDRAM DIMM with no buffer in between
- Address Bus Connection—Connected directly through the MUX to the SDRAM DIMM with no buffer in between
- SDRAM Control Signal Connections—Connected to SDRAM DIMM through a 22 Ω resistor
- BCLKO Rising to Valid Output—The MCF5307 output signals are guaranteed to be valid a maximum of 11 nS after BCLKO is clocked high (parameter B10¹)
- SDRAM Input Setup Time—3 nS for PC66 memory and 2 nS for PC100 memory per Intel® PC SDRAM specification
- SDRAM Input Hold Time—1.5 nS for PC66 memory and 1.0 nS for PC100 memory per Intel® PC SDRAM specification

Thus the MCF5307 to SDRAM Setup Time can be found by the calculation below:

$$\begin{aligned}
 & 22\text{nS (Bus Frequency)} \\
 & -11\text{nS (BCLKO to Valid Output time)} \\
 & - 3\text{nS (PCDRAM setup time)} \\
 & = 8\text{nS timing margin} \\
 & - 5\text{nS MUX PLD max. propagation delay} \\
 & = 3\text{nS worst case timing margin}
 \end{aligned}$$

This indicates that even at the worst case, there is enough margin for the MCF5307 signals to reach a PC66 SDRAM while using the helper MUX.

1.4.1 Write Bus Cycle

A write bus cycle was also evaluated as valid since the published hold time to BCLKO for the MCF5307 is 2.0 nS (Parameter B11) and the input hold time for a PC66 memory is 1.5 nS, leaving 0.5 nS as timing margin.

1.4.2 Read Bus Cycle

Read cycles also meet timing margins for setup and hold times to the MCF5307. For SDRAM to MCF5307 setup time, the following calculation was used:

$$\begin{aligned}
 & 22 \text{ nS (BCLKO period)} \\
 & -10 \text{ nS (Clock to valid data for PC66 memory) // This is 7 nS for PC100 memory} \\
 & - 5.5 \text{ nS (Valid input to BCLKO falling - setup time (parameter B1))} \\
 & = 6.5\text{nS timing margin}
 \end{aligned}$$

¹This corresponds to the parameter value found in the Electrical Specification Section of the MCF5307 User's Manual

For SDRAM to MCF5307 hold time the following calculation was used:

$$\begin{aligned}
 & 3 \text{ nS (Output hold time for PC66 and PC100 memory)} \\
 & - 2 \text{ nS (Input hold time for MCF5307) (Parameter B4)} \\
 & = 1 \text{ nS timing margin}
 \end{aligned}$$

Thus, this analysis indicates all timing has adequate margin, even for PC66 memory, as long as a zero-delay clock driver is used. Although this timing analysis example is for a PC66 memory, there are no timing violations when using PC100 memory either.

1.5 Timing Considerations for Older OH55J Mask

The timing analysis reviewed in the previous section applies to the most recent MCF5307 mask, the 00J20C. For those using the OH55J mask of the MCF5307, the output hold time (parameter B11, and parameter B11a), have different values from the OH55J mask. Specifically, the output hold time for address, data and normal bus control signals is 0.0 nS, and for DRAM control lines such as RAS and CAS, the hold time is -1.0 nS.

Thus, for write cycles, the subtracting a 1.5 nS PC66 input hold time from a -1.5 nS MCF5307 output hold time results in a -3 nS timing margin for SDRAM signals (-2.5 nS for PC100 memory).

In other words, there is insufficient hold time. The proposed solution is to use a clock driver that can provide a 1.0 nS negative propagation delay. This is actually possible with the zero-delay buffers from Cypress. The reference output can be loaded with a 20 pF capacitor, yielding a positive setup time in advance of the clock output. The following is the resultant analysis for all important times.

- MCF5307-to-SDRAM setup time:
 - 22 nS (Bus Frequency)
 - 11 nS (BCLKO to Valid Output time)
 - 2 nS (PC100 Memory Setup time)
 - 1 nS (Clock Driver Advance)
 - = 8 nS timing margin
 - 5 nS MUX PLD max. propagation delay
 - = 3 nS worst case timing margin

- MCF5307-to-SDRAM hold time for writes:
 - 1 nS (worst case Output hold time MCF5307 for SDRAM controls)
 - + 1 nS (advance from clock driver)
 - + 1 nS (1 nS skew from termination resistors)
 - 1 nS (input hold time for PC100 Memory)
 - = 0 nS timing margin

The OH55J mask set MCF5307 Errata published hold time from clock rising edge is 0.0 nS (Parameter B11) for normal signals and -1.0 nS for SDRAM control signals. Given the additional 1 nS advance on the clock with the loaded reference signal, this leaves a 1.0 nS hold time for normal

signals and 0.0 nS for control signals. However, SDRAM control signals are routed through 22 Ohm series termination resistors, before hitting their nominal 50 pF SDRAM input load. This would skew these signals by at least 1.0 nS. Because 1.0 nS is required for PC100 memory, this leaves 0.0 nS timing margin, an adequate outcome.

- SDRAM-to-MCF5307 setup time for reads:
 - 22 nS (BCLKO period)
 - 7 nS (Clock to valid data for PC100 memory) // This is 10 nS for PC66 memory
 - + 1 nS (advance from clock driver)
 - 5.5 nS (Valid input to BCLKO falling - setup time (parameter B1))
 - = 10.5 nS timing margin
- For the SDRAM-to-MCF5307 hold time:
 - 3 nS (Output hold time for PC66 and PC100 memory)
 - 2 nS (Input hold time for MCF5307) (parameter B4)
 - 1 nS (advance from clock)
 - = 0 nS timing margin

Taking into account the 1 nS clock advance with 2 nS required for the MCF5307, the 3 nS hold time of the SDRAM leaves 0 nS timing margin.

Hold times are probably less critical because trace impedances and capacitances on the board will tend to extend these hold times.

In conclusion, using a zero-delay buffer in the negative one nanosecond model works with PC100 memory, assuming that the MCF5307 from the 0H55J mask set is used.

1.6 ABEL Code

The following is the ABEL code file for the helper MUX for interfacing between a MCF5307 and standard 168-pin unbuffered SDRAM:

```

module SDRAMmux
title 'SDRAM Mux Controller for the MCF5307EVM'
"5307mux device 'ispLSI22LV10';
;*****
;"This abel file contains the code to mux the address lines"
;"allowing the MCF5307 to support all 168-pin 1 Bank x 64 bit PC compliant DIMMS"
;"It was targeted to Lattice ispLSI 22LV10 PAL  "
;"All logic with this PAL is com
;"CS: XXX "
;*****
;*****
;"Declaration Section

```

```

; "*****"
; " constants"
    C,P,X,Z,H,L = .C.,.P.,.X.,.Z.,1,0;
; "*****"

M0    PIN    3;           "Mux Input (0)
M1    PIN    4;           "Mux Input (1)
M2    PIN    5;           "Mux Input (2)
M3    PIN    6;           "Mux Input (3)
CA18  PIN    2;           "Input - ColdFire driven address (18)
CA19  PIN    7;           "Input - ColdFire driven address (19)
CA20  PIN    9;           "Input - ColdFire driven address (20)
CA21  PIN   10;           "Input - ColdFire driven address (21)
CA22  PIN   11;           "Input - ColdFire driven address (22)
CA23  PIN   12;           "Input - ColdFire driven address (23)
CA24  PIN   13;           "Input - ColdFire driven address (24)
CA25  PIN   16;           "Input - ColdFire driven address (25)
CA26  PIN   23;           "Input - ColdFire driven address (26)
CA27  PIN   21;           "Input - ColdFire driven address (27)
SA8   PIN   24;           "Output - SDRAM input address (A8)
SA9   PIN   19;           "Output - SDRAM input address (A9)
SA10  PIN   25;           "Output - SDRAM input address (A10)
SA11  PIN   17;           "Output - SDRAM input address (A11)
SA12  PIN   27;           "Output - SDRAM input address (A12)
SA13  PIN   20;           "Output - SDRAM input address (A13)
BA0   PIN   18;           "Output - SDRAM input address (BA0)
BA1   PIN   26;           "Output - SDRAM input address (BA1)

select = [M3,M2,M1,M0];

; "*****"
; " Lattice attributes "
; "*****"

;pLSI property 'CLK XCLK0 CLK0 ';
;pLSI property 'CLK CLK8MHZ SLOWCLK ';
pLSI property 'ISP ON';
pLSI property 'PULLUP ON';

```

```
pLSI property 'Y1_AS_RESET OFF';

equations

; "#####"
; "COMBINATORIAL Logic Only"
; "#####"

when (select == 0) then {SA8=CA18;
                        SA9=CA19;
                        SA10=CA20;
                        BA0=CA21;
                        BA1=CA22;
                        }

when (select == 1) then {SA8=CA19;
                        SA9=CA20;
                        SA10=CA21;
                        BA0=CA22;
                        BA1=CA23;
                        }

when (select == 2) then {SA8=CA19;
                        SA9=CA21;
                        SA10=CA22;
                        BA0=CA23;
                        BA1=CA24;
                        }

when (select == 3) then {SA8=CA18;
                        SA9=CA19;
                        SA10=CA20;
                        SA11=CA21;
                        BA0=CA22;
                        BA1=CA23;
                        }
```

```
    }  
  
when (select == 4) then {  
    SA8=CA19;  
    SA9=CA20;  
    SA10=CA21;  
    SA11=CA22;  
    BA0=CA23;  
    BA1=CA24;  
}  
  
when (select == 5) then {  
    SA8=CA19;  
    SA9=CA21;  
    SA10=CA22;  
    SA11=CA23;  
    BA0=CA24;  
    BA1=CA25;  
}  
  
when (select == 6) then {  
    SA8=CA19;  
    SA9=CA21;  
    SA10=CA23;  
    SA11=CA24;  
    BA0=CA25;  
    BA1=CA26;  
}  
  
when (select == 7) then {SA8=CA18;  
    SA9=CA19;  
    SA10=CA20;  
    SA11=CA21;  
    SA12=CA22;  
    BA0=CA23;  
    BA1=CA24;  
}
```

```

when (select == 8) then {SA8=CA19;
                        SA9=CA20;
                        SA10=CA21;
                        SA11=CA22;
                        SA12=CA23;
                        BA0=CA24;
                        BA1=CA25;
                        }

when (select == 9) then {SA8=CA19;
                        SA9=CA21;
                        SA10=CA22;
                        SA11=CA23;
                        SA12=CA24;
                        BA0=CA25;
                        BA1=CA26;
                        }

when (select == ^h0A) then {SA8=CA19;
                            SA9=CA21;
                            SA10=CA23;
                            SA11=CA24;
                            SA12=CA25;
                            BA0=CA26;
                            BA1=CA27;
                            }

*****
" Test Vector Section"
*****
test_vectors 'M0, M1, M2, M3 Test Vector'
([M3, M2, M1, M0, CA18, CA19, CA20, CA21, CA22, CA23, CA24, CA25, CA26, CA27]-
>[SA8, SA9, SA10, SA11, SA12, BA0, BA1])
[0,0,0,0,1,0,1,0,1,0,1,0,1,0]->[X,X,X,X,X,X,X];
[0,0,0,1,1,0,1,0,1,0,1,0,1,0]->[X,X,X,X,X,X,X];

```



```

SA8      = (  CA18 & M0 & M1 & !M3
              #  CA18 & !M0 & !M1 & !M2 & !M3
              #  M0 & !M1 & !M2 & CA19
              #  !M0 & !M2 & M3 & CA19
              #  !M0 & M1 & !M3 & CA19
              #  !M1 & M2 & !M3 & CA19 );

SA9      = (  M0 & M1 & !M3 & CA19
              #  !M0 & !M1 & !M2 & !M3 & CA19
              #  !M0 & !M1 & !M2 & M3 & CA20
              #  !M0 & !M1 & M2 & !M3 & CA20
              #  M0 & !M1 & !M2 & !M3 & CA20
              #  !M0 & M1 & !M2 & CA21
              #  M0 & !M1 & !M2 & M3 & CA21
              #  !M0 & M1 & !M3 & CA21
              #  M0 & !M1 & M2 & !M3 & CA21 );

SA10     = (  M0 & M1 & !M3 & CA20
              #  !M0 & !M1 & !M2 & !M3 & CA20
              #  !M0 & !M1 & !M2 & M3 & CA21
              #  !M0 & !M1 & M2 & !M3 & CA21
              #  M0 & !M1 & !M2 & !M3 & CA21
              #  M0 & !M1 & !M2 & M3 & CA22
              #  M0 & !M1 & M2 & !M3 & CA22
              #  !M0 & M1 & !M2 & !M3 & CA22
              #  !M0 & M1 & !M2 & M3 & CA23
              #  !M0 & M1 & M2 & !M3 & CA23 );

SA11     = (  M0 & M1 & !M3 & CA21
              #  !M0 & !M1 & !M2 & M3 & CA22
              #  !M0 & !M1 & M2 & !M3 & CA22
              #  M0 & !M1 & !M2 & M3 & CA23
              #  M0 & !M1 & M2 & !M3 & CA23
              #  !M0 & M1 & !M2 & M3 & CA24
              #  !M0 & M1 & M2 & !M3 & CA24 );
    
```

```
SA12 = ( M0 & M1 & M2 & !M3 & CA22
        # !M0 & !M1 & !M2 & M3 & CA23
        # M0 & !M1 & !M2 & M3 & CA24
        # !M0 & M1 & !M2 & M3 & CA25 );
```

```
BA0 = ( !M0 & !M1 & !M2 & !M3 & CA21
        # M0 & !M2 & !M3 & CA22
        # M0 & M1 & M2 & !M3 & CA23
        # !M0 & !M1 & M2 & !M3 & CA23
        # !M0 & M1 & !M2 & !M3 & CA23
        # !M0 & !M1 & !M2 & M3 & CA24
        # M0 & !M1 & M2 & !M3 & CA24
        # M0 & !M1 & !M2 & M3 & CA25
        # !M0 & M1 & M2 & !M3 & CA25
        # !M0 & M1 & !M2 & M3 & CA26 );
```

```
BA1 = ( !M0 & !M1 & !M2 & !M3 & CA22
        # M0 & !M2 & !M3 & CA23
        # M0 & M1 & M2 & !M3 & CA24
        # !M0 & !M1 & M2 & !M3 & CA24
        # !M0 & M1 & !M2 & !M3 & CA24
        # !M0 & !M1 & !M2 & M3 & CA25
        # M0 & !M1 & M2 & !M3 & CA25
        # M0 & !M1 & !M2 & M3 & CA26
        # !M0 & M1 & M2 & !M3 & CA26
        # !M0 & M1 & !M2 & M3 & CA27 );
```

Mfax is a trademark and Coldfire is a registered trademark of Motorola, Inc.
ispEXPERT is a trademark of Lattice Semiconductor.
Intel is a registered trademark of Intel Corporation.

Motorola reserves the right to make changes without further notice to any products herein. Motorola makes no warranty, representation or guarantee regarding the suitability of its products for any particular purpose, nor does Motorola assume any liability arising out of the application or use of any product or circuit, and specifically disclaims any and all liability, including without limitation consequential or incidental damages. "Typical" parameters can and do vary in different applications. All operating parameters, including "Typicals" must be validated for each customer application by customer's technical experts. Motorola does not convey any license under its patent rights nor the rights of others. Motorola products are not designed, intended, or authorized for use as components in systems intended for surgical implant into the body, or other applications intended to support or sustain life, or for any other application in which the failure of the Motorola product could create a situation where personal injury or death may occur. Should Buyer purchase or use Motorola products for any such unintended or unauthorized application, Buyer shall indemnify and hold Motorola and its officers, employees, subsidiaries, affiliates, and distributors harmless against all claims, costs, damages, and expenses, and reasonable attorney fees arising out of, directly or indirectly, any claim of personal injury or death associated with such unintended or unauthorized use, even if such claim alleges that Motorola was negligent regarding the design or manufacture of the part.

Motorola and  are registered trademarks of Motorola, Inc. Motorola, Inc. is an Equal Opportunity/Affirmative Action Employer.

Motorola Literature Distribution Centers:

USA/EUROPE: Motorola Literature Distribution; P.O. Box 5405; Denver, Colorado 80217; Tel.: 1-800-441-2447 or 1-303-675-2140;

World Wide Web Address: <http://ltdc.nmd.com/>

JAPAN: Nippon Motorola Ltd SPD, Strategic Planning Office 4-32-1, Nishi-Gotanda Shinagawa-ku, Tokyo 141, Japan Tel.: 81-3-5487-8488

ASIA/PACIFIC: Motorola Semiconductors H.K. Ltd Silicon Harbour Centre 2, Dai King Street Tai Po Industrial Estate Tai Po, New Territories, Hong Kong

Mfax™: RMFAX0@email.sps.mot.com; TOUCHTONE 1-602-244-6609; US & Canada ONLY (800) 774-1848;

World Wide Web Address: <http://sps.motorola.com/mfax>

INTERNET: <http://motorola.com/sps>

Technical Information: Motorola Inc. SPS Customer Support Center 1-800-521-6274; electronic mail address: crc@wmkmail.sps.mot.com.

Document Comments: FAX (512) 895-2638, Attn: RISC Applications Engineering.

World Wide Web Addresses: <http://www.motorola.com/PowerPC>

<http://www.motorola.com/netcomm>

<http://www.motorola.com/HPESD>



MOTOROLA

AN1802/D

Freescale Semiconductor, Inc.

APPENDIX EVALUATION BOARD BOM

MCF5307EVM_BOM

Item	Quantity	Reference	Part	Extra Information
1	11	C1, C15, C16, C24, C35, C36, C48, C49, C53, C65, C112	10 UF TANT.	16V
2	3	C2, C5, C64	0.01 UF	0805 X7R material
3	66	C3, C4, C14, C17, C18, C19, C25, C26, C27, C28, C29, C30, C31, C32, C33, C34, C37, C42, C43, C44, C45, C46, C47, C54, C55, C56, C57, C58, C59, C60, C61, C62, C63, C66, C68, C71, C72, C73, C74, C75, C76, C77, C78, C89, C90, C92, C93, C94, C95, C96, C97, C98, C99, C100, C101, C102, C103, C104, C105, C106, C107, C108, C109, C110, C111, C113	0.1 UF	0805 X7R material
4	32	C6, C7, C8, C9, C10, C11, C12, C13, C20, C21, C22, C23, C38, C39, C40, C41, C50, C51, C52,	1500 PF	0805 NPO material

Freescale Semiconductor, Inc.

Freescale Semiconductor, Inc.

		C67, C69, C70, C79, C80, C81, C82, C83, C84, C85, C86, C87, C88		
5	1	C91	200 UF	16V
6	3	D1, D2, D3	GREEN LED	P521TR-ND, PANASONIC.
7	1	D4	1N5404CT	
8	3	D5, D7, D9	LED SMT GRN	P521TR-ND, PANASONIC.
9	5	D6, D8, D10, D11, D12	LED SMT RED	RED LED
10	2	D13, D14	LED SMT YEL	RED LED
11	1	D15	*IRQ7	P521TR-ND, PANASONIC.
12	15	JP1, JP2, JP3, JP4, JP5, JP6, JP7, JP14, JP15, JP16, JP17, JP18, JP19, JP20, JP21	JUMPER3	1x3 100 mil jumper header 6mm high
13	1	JP8	TOUT1	1x2 100 mil jumper header 6mm high
14	1	JP9	TOUT0	1x2 100 mil jumper header 6mm high
15	1	JP10	3.3V	1x2 100 mil jumper header 6mm high
16	1	JP11	1.8V	1x2 100 mil jumper header 6mm high
17	2	JP12, JP13	DREQ	1x2 100 mil jumper header 6mm high
18	1	J1	HJ2X13 KEYED w/ plastic outline	2x13 100 mil header 6mm high
19	1	J2	JUMP1X8	1x8 100 mil header 6mm high
20	1	J3	HJ2X17	2x17 100 mil header 6mm high
21	1	J4	HJ2X30	2x30 100 mil header 6mm high
22	1	J5	HJ2X19	2x19 100 mil header 6mm high
23	5	LA1, LA2, LA3, LA4, LA5	Mictor_Connector AMP	

Freescale Semiconductor, Inc.

Freescale Semiconductor, Inc.

			767054-1	
24	1	L1	FERRITE_BEAD	BLM31A700SPT
25	1	P1	NEWARK/46F89	Red Momentary
			7	Switch
26	1	P2	NEWARK/93F77	Black Momentary
			15	Switch
27	2	P4, P3	DB9 RS232 PORT	
			THRU HOLE DB9	
28	1	P5	RJ45 Thur Hole	
29	1	R1	10K	0805 body style
30	44	R2, R3, R4, R5, R6, R11, R12, R14, R15, R17, R18, R19, R20, R25, R26, R27, R31, R32, R33, R34, R42, R43, R44, R45, R46, R47, R48, R49, R50, R51, R52, R53, R54, R55, R56, R57, R58, R59, R60, R71, R73, R75	4.7K	0805 body style
		R7, R9, R21, R61, R62, R63, R64, R65, R66, R67, R68, R69, R70, R72		
31	15		270	0805 body style
32	2	R13, R10	49.9	0805 body style
33	21	R16, R24, R28, R29, R30, R35, R36, R37, R38, R39, R40, R41, R78, R79, R80, R81, R82, R83, R84, R85, R86	22	0805 body style
34	2	R23, R22	2K	0805 body style
35	1	R74	10	0805 body style
36	4	SP1, SP2, SP3, SP4	4.7Kx9	4.7K Ohms 100mil inline resistor package
37	1	S1	KS11R23CQD	C&K
38	1	S2	KS11R22CQD	C&K

Freescale Semiconductor, Inc.

Freescale Semiconductor, Inc.

39	17	T1, T2, T3, T4, T5, T6, T7 , T9, T10, T11, T12, T13, T14 , T15, T16, T17	TEST_Points	
40	1	U1	MCF5307FT90	Motorola ColdFire
41	1	U2	MC145407DW	Motorola RS232 drivers
42	1	U3	MC145406DW	Motorola RS232 drivers
43	1	U4	TLC7733ID	TI
44	1	U5	TL7705ACD	TI
45	1	U6	OSC 20 MHZ	Pletronics P1100-HCS
46	1	U7	FD22-101G	Halo Electronics
47	1	U9	ispLSI2032V- 100LJ SMT socket	Lattice 44pin PLCC w/ SMT socket
48	1	U10	MC74LCX244DW	Motorola 8bit uni- directional buffer
49	2	U11, U15	MC74LCX16244 DT	Motorola 16bit uni- directional buffer
50	1	U12	DM9008F	Davicom
51	1	U13	AT93C46-10SC- 2.7 not populated during assembly	
52	1	U14	LT1086CT5.0	
53	2	U25, U16	MC74LCX16245 DT	Motorola 16bit bi- directional buffer
54	1	U17	LT1086CT3.3	
55	1	U18	CDC351DW MCM69F737TQ1 1 not populated during assembly	TI 24pin SMT package
56	1	U19	AM29LV004T- 100EC	AMT 40 pin TSOP package
57	2	U20, U21	OSC 45 MHZ	Pletronics P1100-HCV
58	1	U22	168 DIMM socket w/	PC100 Unbuffered 1 Bank x 64 DIMM 8M or 16M, support up to
59	1	U23		

Freescale Semiconductor, Inc.

60	1	U24	ispGAL22LV10 SMT socket	512M Lattice 28 pin PLCC w/ SMT socket
----	---	-----	----------------------------	--

Freescale Semiconductor, Inc.

