

# RENLIIG

GB

FWM7



Design and Quality  
IKEA of Sweden





## Contents

Safety information	4	Consumption values	17
Product description	7	Care and cleaning	18
Control panel	8	What to do if...	20
First use	10	Technical data	23
Personalisation	11	Installation	24
Daily use	11	Electrical connection	24
Helpful hints and tips	14	Environment concerns	25
Washing programmes	15	IKEA GUARANTEE	25

Subject to change without notice

## Safety information

 For your safety and correct operation of the appliance, read this manual carefully before installation and use. Always keep these instructions with the appliance even if you move or sell it. Users must fully know the operation and safety features of the appliance.

The manufacturer is not responsible for damages caused by incorrect installation and use.

### Children and vulnerable people safety

- Do not let persons, children included, with reduced physical sensory, reduced mental functions or lack of experience and knowledge to use the appliance. They must have supervision or instruction for the operation of the appliance by a person who is responsible for their safety.
- Keep all packaging well away from children. There is risk of suffocation.
- Keep all detergents in a safe area. Do not let children touch the detergents.
- Make sure that children or pets do not climb into the drum. Please check into the drum before using it.

This appliance incorporates a special feature to prevent children and pets becoming trapped inside the drum.

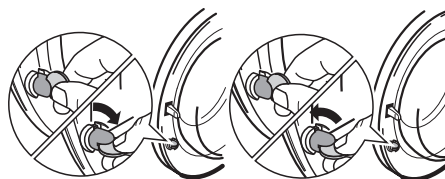

To activate this device, rotate the button clockwise (without pressing it) inside the door until the groove is horizontal. If necessary use a coin.

To disable this device and restore the possibility of closing the door, rotate the button anticlockwise until the groove is vertical.

### General safety

- Do not change the specifications or modify this product. There is risk of injury and damage to the appliance.
- If the appliance is delivered in the winter months when there are minus temperatures, store it at room temperature for 24 hours before using for the first time. Please read the “dangers of freezing” chapter.
- This appliance is designed for use in normal inside temperature. Manufacturer is not responsible for freezing damages.
- Always unplug the appliance and turn off the water supply after use, cleaning and maintenance.

### Installation

- A qualified and competent person must do the electrical and the plumbing installation.
- This appliance is heavy. Take care when you move it.
- Make sure that the appliance is not damaged because of transport. Do not connect a damaged appliance. If necessary, contact dedicated After Sales Service.
- Remove all packaging and transit bolts before first use. Serious damage can occur to the appliance or to neighbouring cabinets or furniture.
- Keep all transit devices so that they can be refitted if the appliance ever has to be transported again. Please refer to the relevant steps in the Assembly Instruction.
- Never place cardboard, wood or similar materials under the appliance to compensate for any unevenness in the floor. Level accurately the appliance and tight the lock nuts to prevent vibration, noise and displacement of the appliance during operation.
- If your appliance is installed on a carpeted floor, adjust the feet in order to ensure that the air must circulate freely under the appliance.
- Check that your appliance is not standing on the inlet and drain hose and the worktop or the back of the appliance is not pressing the electrical supply cable against the wall.
- Always be sure, that there is no water leakage from hoses and their connections after the installation.
- If the appliance is installed in a location subject to frost, please read the “dangers of freezing” chapter.

### Use

- The appliance is only for domestic use. Do not use the appliance for commercial and industrial use or for other uses.
- Only an authorised service engineer can repair this appliance. Use only original spare parts.
- Refer to the instructions on the label of each item (garment) before washing.

- Do not overload the appliance. See the Washing Programme Table.
- Before washing, ensure that all pockets are empty and buttons and zips are fastened.
- Any objects such as coins, safety pins, nails, screws, stones or any other hard, sharp material can cause extensive damage and must not be placed into the appliance.
- Treat stains such as paint, ink, rust, and grass before washing.
- Only use the advised quantities of fabric softener and detergent. Damage to the fabric can ensue if you overfill. Refer to the manufacturer’s recommendations of quantities.
- Wash small items such as socks, laces, washable belts etc. in a washing bag or pillow case as it is possible for such items to slip down between the tub and the inner drum.
- Do not use your appliance to wash articles with whalebones, items without hems, frayed and torn. Underwired bras must NOT be washed.
- Garments which have been in contact with volatile petroleum products should not be appliance washed. If volatile cleaning fluids are used, care should be taken to ensure that the fluid is removed from the garment before placing in the appliance.
- The water we use normally contains lime. It is a good idea to periodically use a water softening powder in the appliance. Do this without any laundry into the drum and according to the softening powder manufacturer’s instructions. This will help to prevent the formation of lime deposits making your appliance more efficiency.
- Never pull the power supply cable to remove the plug from the socket; always take hold of the plug itself.
- Never use the appliance if the power supply cable, the control panel, the working surface or the base is damaged so that the inside of the appliance is accessible.

### Water inlet

- This appliance must be connected to a cold water supply.

- Do not use connection hoses from an old appliance to connect it to the water supply.
- The water pressure must be in the limits (refer to the chapter «Technical data» table). Make sure that the local water authority gives you the average mains pressure in your area.
- Make sure that there are no kinks in the water inlet hose and that the water inlet hose is not squashed or entangled.
- Before connecting up the appliance to new pipework or to pipework that has not been used for some time, run off a reasonable amount of water to flush out any debris that may have collected in the pipes.
- Turn the inlet hose on the back of the appliance to the left or the right to suit the installation.
- The inlet hose must not be lengthened. If it is too short and you do not wish to move the tap, you will have to purchase a new, longer hose specially designed for this type of use.
- Before opening the water tap, be sure to tighten the ring nut well to prevent any leaks.

### **Water drainage**

- Make sure the end of the drain hose cannot come unhooked when the appliance is emptying. This could be done by tying it to the tap with a piece of string or attaching it to the wall.
- The drain hose must be placed at a height of not less than 44 cm and not more than 90 cm. Please refer to the Assembly Instruction booklet.

### **Care and cleaning**

- Before maintenance, switch off the appliance and disconnect the mains plug from the mains socket.
- Clean the exterior cabinet of the appliance with soap and water only, and then dry thoroughly.
- The washing powder and additive dispenser drawer should be cleaned regularly.
- Inspected the pump regularly and particularly if:
  - the appliance does not empty and/or spin
  - the appliance makes an unusual noise during draining due to objects such as safety pins, coins etc. blocking the pump.
- Never remove the pump cover during a wash cycle. Always wait until the appliance has drained out the water. If you have selected an high temperature washing programme please wait until the water has cooled down.
- Ensure that the pump cover is securely re-tightened to prevent any leaks.

## Product description

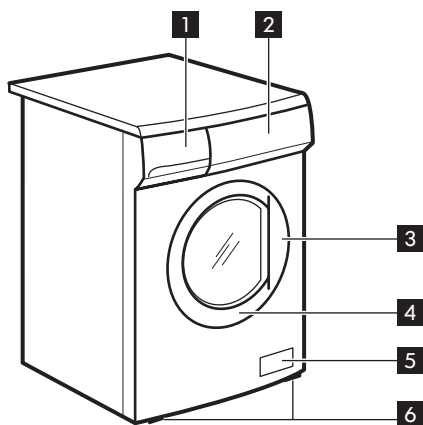



- 1** Detergent dispenser drawer
- 2** Control panel
- 3** Door opening handle
- 4** Rating Plate
- 5** Drain pump
- 6** Adjustable feet

### Detergent dispenser drawer

 Compartment for detergent used for prewash and soak phase or for stain remover used during the stain action phase (if available). The prewash and soak detergent is added at the beginning of the wash programme. The stain remover is added during the stain action phase.

 Compartment for powder or liquid detergent used for main wash. If using liquid detergent pour it just before starting the programme.

 Compartment for liquid additives (fabric softener, starch).

 Follow the product manufacturer's recommendations on quantities to use and do not ever exceed the «MAX» mark in the detergent dispenser drawer. Any fabric softener or starching additives must be poured into the compartment before starting the wash programme.

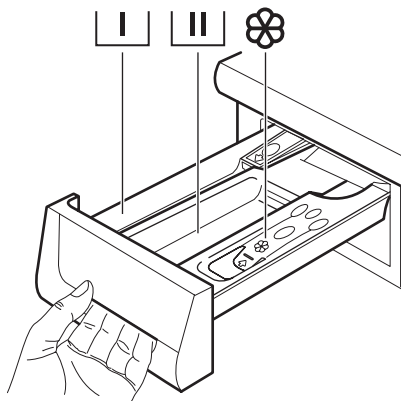

Control panel

Below is a picture of the control panel. It shows the programme selector dial as well as the buttons and the indicator lights. These are presented by relevant numbers on the following pages.

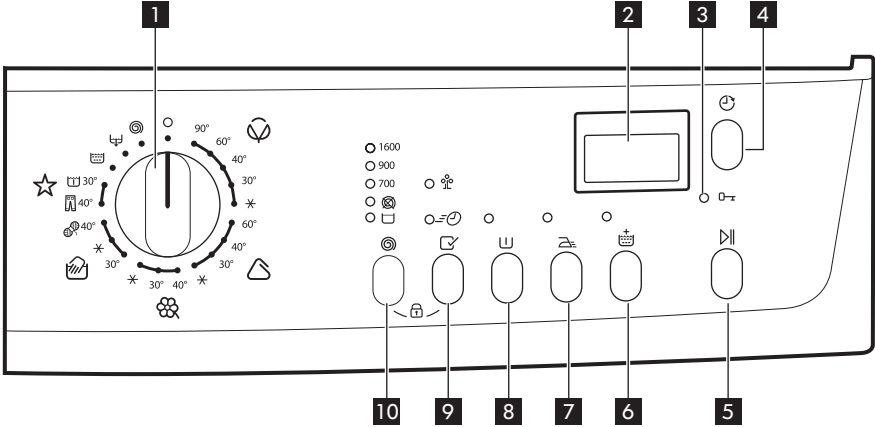

- 1** Programme selector dial
- 2** Display
- 3** Door locked indicator light
- 4** Delay Start button
- 5** Start/Pause button
- 6** Extra Rinse button
- 7** Easy Iron button
- 8** Prewash button
- 9** Multi-Functions button
- 10** Spin reduction button

Table of symbols

○ = On/Off - Reset	⦿ = Spin
☺ = Cottons	⊗ = No spin
✱ = Cold wash	☒ = Rinse Hold
△ = Synthetics	☑ = Options
☼ = Delicates	☼ = Economy
☞ = Handwash	☑ = Quick Wash
☼ = Wool	☒ = Prewash
☆ = Special programmes	☑ = Easy Iron
☒ = Jeans	☑ = Extra Rinse
☒ = Soak	⏸ = Start/Pause
☒ = Rinses	☒ = Door locked
☒ = Drain	⌚ = Delay Start

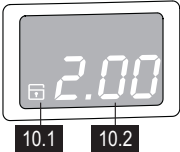

Programme selector dial	It allows you to switch the appliance On/Off and/or to select a programme.
Spin reduction button	By pressing this button you can change the spin speed of the selected programme. <ul style="list-style-type: none"> <li>• No Spin option: by selecting this option, all spinning phases are suppressed and replaced by a drain, so as not to wrinkle the laundry. Recommended for extremely delicate fabrics.</li> <li>• Rinse Hold option: by selecting this option the water of the last rinse is not emptied out to prevent the fabrics from creasing. Before opening the door it will be necessary to empty out the water. To empty out the water, please read the paragraph «At the end of the programme».</li> </ul>
Multi-Functions button:	By pressing this button, you can select only one of the options. The relevant indicator light will light up. <ul style="list-style-type: none"> <li>• Economy: recommended washing programme for cottons and synthetic items lightly or normally soiled at a temperature of 40° C or higher. The washing time will be prolonged and the washing temperature will be reduced. You can use this option if you want to wash normally soiled laundry and at the same time save energy.</li> <li>• Super Quick: a very short cycle for slightly soiled items that have been worn for a short time.</li> </ul>
Prewash button	By selecting this option the appliance performs a prewash cycle before the main wash phase. The washing time will be prolonged. This option is recommended for heavily soiled laundry.
Easy Iron button	By selecting this option the laundry is gently washed and spun to avoid any creasing. In this way ironing is easier. Furthermore the machine will perform some additional rinses in some programmes. On cotton programmes the maximum spin speed is reduced automatically.
Extra Rinse button	This appliance is designed for saving energy. If it necessary to rinse the laundry using an extra quantity of water (extra rinse), select this option. Some additional rinses will be performed. This option is recommended for people who are allergic to detergents, and in areas where the water is very soft.
Start/Pause button	This button allows you to start or to interrupt the selected washing programme.
Door Locked indicator light	The indicator light <b>3</b> illuminates when the programme starts and indicates if the door can be opened: <ul style="list-style-type: none"> <li>• light on: the door cannot be opened. The machine is working or has stopped with water left in the tub.</li> <li>• light off: the door can be opened. The programme is finished or the water has been emptied out.</li> <li>• light blinking: the door is opening in a few minutes.</li> </ul>

<p>Delay Start button</p>	<p>The programme can be delayed from 30 min - 60 min - 90 min, 2 hours and then by 1 hour up to a maximum of 20 hours by means of this button.</p>
<p>Display</p> 	<p>The display shows the following information:</p> <ul style="list-style-type: none"> <li>• <b>10.1</b> <ul style="list-style-type: none"> <li>– Child safety lock. This device permits you to leave the appliance unattended during its functioning.</li> </ul> </li> <li>• <b>10.2</b> <ul style="list-style-type: none"> <li>– Duration of the selected programme. After selecting a programme, the duration is displayed in hours and minutes (for example <i>2.05</i>). The duration is calculated automatically on the basis of the maximum recommended load for each type of fabric. After the programme has started, the time remaining is updated every minute.</li> <li>– Delayed start. The Selected delay set by pressing the relevant button appears on the display for a few seconds, then the duration of the selected programme is displayed again. The delay time value decreases by one unit every hour and then, when 1 hour remains, every minute.</li> <li>– Alarm codes. In the event of operating problems, some alarm codes can be displayed, for example <i>E20</i> (see paragraph «What to do if...»).</li> <li>– Incorrect option selection. If an option which is not compatible with the set wash programme is selected, the message <b>Err</b> is displayed at the bottom of the display for a few seconds and the integrated red indicator light of button <b>5</b> start flashing.</li> <li>– End of programme. When the programme has finished the flashing zero (0) is displayed, the indicator light <b>3</b> and the indicator light of button <b>5</b> go out and the door can be opened.</li> </ul> </li> </ul>

## First use

- i
  - Ensure that the electrical and water connections comply with the installation instructions.
  - Remove the polystyrene block and any material from the drum.
- Before the first wash, run a cotton cycle at the highest temperature without any laundry in the machine, to remove any manufacturing residue from the drum and tub. Pour 1/2 a measure of detergent into the main wash compartment and start the machine.

## Personalisation

### Acoustic signals

The machine is provided with an acoustic device, which sounds in the following cases:

- at the end of the cycle
- if there is a fault.

By pressing the **7** and **8** buttons simultaneously for about **6 seconds**, the acoustic signal is deactivated (except if there is a fault). By pressing these 2 buttons again, the acoustic signal is reactivated.

### Child safety lock

This device permits you to leave the appliance unattended so you do not need to worry that children might be injured by or cause damage to the appliance. This function remains enabled also when the washing machine is not working.

There are two different ways to set this option:

1. Before pressing button **5**: it will be impossible to start the machine.
2. After pressing button **5**: it will be impossible to change any other programme or option.

To enable or disable this option press simultaneously for about 6 seconds buttons **9** and **10** until on the display, the icon  appears or disappears.

## Daily use

### Open the door

Open the door by carefully pulling the door handle outwards.

### Load the laundry

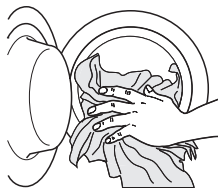



Place the laundry in the drum, one item at a time, shaking them out as much as possible.

By pushing the port-hole frame, close firmly the door.

### Measure out detergent and fabric softener

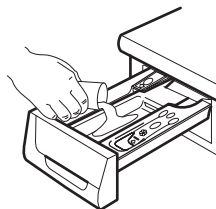
1



Pour the detergent into the main wash compartment  or in the appropriate compartment if the selected programme/option it requires (see more details in "Detergent dispenser drawer"). To pour the right quantity of the detergent, see more details in "Degrees of water hardness".

2

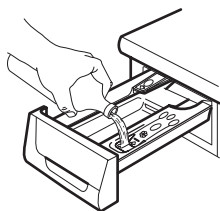



Pour fabric softener into the compartment marked  (must not exceed the «MAX» mark in the drawer).

### Close the drawer gently

### Select the required programme by turning the programme selector dial (1)

The appliance is now switched on. The indicator light of button **5** starts to blink. At the end of the programme the selector dial must be turned to position **O**, to switch the appliance off.

 For the description of each wash cycle, the compatibility among the washing programmes and the options, consult the chapter «Washing Programmes».

 **Caution!** If you turn the programme selector dial to another programme when the appliance is working, the red indicator light of button **5** will blink 3 times and the message **Err** appears on the display to indicate a wrong selection. The appliance will not perform the new selected programme.

### Reduce the spin speed or select the No Spin or Rinse Hold by pressing button 10

By selecting a programme, the appliance proposes automatically the maximum spin speed provided for that programme. Press button **10** repeatedly to change the spin speed, if you want your laundry to be spun at a different speed. The relevant indicator light illuminates.

### Select the available options by pressing buttons 6, 7, 8 and 9

Depending on the programme, different functions can be combined. These must be selected after choosing the desired programme and before starting the programme.

When these buttons are pressed, the corresponding indicator lights illuminate. When they are pressed again, the indicator lights go out. If an incorrect option is selected, the integrated red indicator light of the button **5** flashes for 3 times and the message **Err** appears on the display.

 For the compatibility among the washing programmes and the options see chapter «Washing Programmes».

### Select the Delay Start by pressing button 4

Before you start the programme, if you wish to delay the start, press this button to select the desired delay.

The selected delay time value will appear on the display for a few seconds, then the duration of the programme will appear again. You must select this option after you have set the programme and before you start the programme.

You can cancel or modify the delay time at any moment, before you press button **5**.

Selecting the delay start :

1. Select the programme and the required options.
2. Select the delay start by pressing button **4**.
3. Press button **5**:
  - the machine starts its hourly count-down.
  - the programme will start after the selected delay has expired.

Cancelling the Delay Start after having started the programme:

1. Set the washing machine to PAUSE by pressing button **5**.
2. Press button **4** once. On the display will appear .
3. Press button **5** again to start the programme.

- The selected delay can be changed only after selecting the washing programme again.
- The door will be locked throughout the delay time. If you need to open the door, you must first set the washing machine to PAUSE by pressing button **5** and wait a few minutes before opening the door. After you have closed the door, press the same button again.
- The Delay Start **cannot** be selected with the draining programme.

### Start the programme by pressing button **5**

To start the selected programme, press this button; the corresponding green indicator light stops blinking.

The indicator light **3** illuminates to indicate that the appliance starts operating and the door is locked.

If you have chosen a delayed start, the machine will begin the countdown.

- If an incorrect option is selected, the message **Err** appears on the display for a few seconds and the **red** indicator light of the button **5** blinks 3 times.

### Altering an option or a running programme

It is possible to change some options before the programme carries them out.

Before you make any change, you must PAUSE the appliance by pressing the button **5**.

Changing a running programme is possible only by resetting it. Turn the programme selector dial to **0** and then to the new programme position. Start the new programme by pressing the button **5** again. The washing water in the tub will be not emptied out.

### Interrupting a programme

Press the button **5** to interrupt a programme which is running, the corresponding green indicator light starts blinking.

Press the button again to restart the programme.

### Cancelling a programme

Turn the selector dial to **0** to cancel a programme which is running.

You can select now a new programme.

### Opening the door after the programme has started

First set the machine to pause by pressing the button **5**.

If the indicator light **3** blinks and after a few minutes goes off, the door can be opened. If the indicator light **3** remains lit, this means that the machine is already heating or that the water level is too high. In any case, do not try to force the door open!

If you cannot open the door but you need to open it, you have to switch the machine off by turning the selector dial to **0**. After a few minutes the door can be opened.

After closing the door, it is necessary to select the programme and options again and to press button **5**.

- **Caution!** Pay attention to the water level and temperature!

### At the end of the programme

The machine stops automatically. Some acoustic signals sound and a blinking  appears on the display, the indicator light of button **5** and the indicator light **3** go off.

If a programme or an option that ends with water left in the tub has been selected, the indicator light **3** remains on and the door is locked to indicate that the water must be emptied out before opening the door.

To empty out the water:

1. Turn the programme selector dial to **0**.
2. Select the draining or spinning programme.
3. Reduce the spin speed if needed, by pressing button **10**.
4. Press button **5**.

At the end of the programme, the door is released and can be opened. Turn the programme selector dial to **0** to switch the machine off.

Remove the laundry from the drum and carefully check that the drum is empty. If you do not intend to carry out another wash, close the water tap. Leave the door open to prevent the formation of mildew and unpleasant smells.

**Stand by** : once the programme has finished after a few minutes the energy saving system will be enabled. The brightness of the display is reduced. By pressing any button the appliance will come out of the energy saving status.

## Helpful hints and tips

### Sorting out the laundry

Follow the wash code symbols on each garment label and the manufacturer's washing instructions. Sort the laundry as follows: whites, coloureds, synthetics, delicates, woolens.

### Removing stains

Stubborn stains may not be removed by just water and detergent. It is therefore advisable to treat them prior to washing.

Blood: treat fresh stains with cold water. For dried stains, soak overnight in water with a stain remover product then rub in the soap and water.

Oil based paint: moisten with benzine stain remover, lay the garment on a soft cloth and dab the stain; treat several times.

Dried grease stains: moisten with turpentine, lay the garment on a soft surface and dab the stain with the fingertips and a cotton cloth.

Rust: oxalic acid dissolved in hot water or a rust removing product used cold. Be careful with rust stains which are not recent since the cellulose structure will already have been damaged and the fabric tends to hole.

Mould stains: treat with bleach, rinse well (white cottons and fast coloureds only).

Grass: soap lightly and treat with bleach (white cottons and fast coloureds only).

Ball point pen and glue: moisten with acetone<sup>1)</sup>, lay the garment on a soft cloth and dab the stain.

Lipstick: moisten with acetone as above, then treat stains with methylated spirits. Treat any residual marks with bleach.

Red wine: soak in water and detergent, rinse and treat with acetic or citric acid, then rinse. Treat any residual marks with bleach.

Ink: depending on the type of ink, moisten the fabric first with acetone<sup>1)</sup>, then with acetic acid; treat any residual marks on white fabrics with bleach and then rinse thoroughly.

Tar stains: first treat with stain remover, methylated spirits or benzine, then rub with detergent paste.

### Degrees of water hardness

Water hardness is classified in so-called "degrees" of hardness. Information on hardness of the water in your area can be obtained from the relevant water supply company, or from your local authority.















Characteristic	Degrees of water hardness	
	German °dH	French °T.H.
Soft	0-7	0-15
Medium	8-14	16-25
Hard	15-21	26-37
Very hard	> 21	> 37





**i** A water softener must be added when water has a medium-high degree of hardness. Follow the manufacturer's instructions. The quantity of detergent can then always be adjusted (reduced) to degree of hardness soft.

1) do not use acetone on artificial silk

## Washing programmes

 Please always refer to the care label symbol of your garment and select the washing programme based on what it says.

Programme/ Temperature	Type of laundry	Cycle Description	Max. Load Red. Load <sup>1)</sup>	Available Options	Detergent Compartment
COTTONS 90°-60°	White cotton (heavy- normally soiled items).	Main wash Rinses Max. final spin at 1600 rpm	7 kg 3.5 kg <sup>1)</sup>	Spin No Spin Rinse Hold Economy <sup>2)</sup> Super Quick Prewash Easy Iron Extra Rinse	 <sup>3)</sup>  
COTTONS 40°-30°-Cold	Coloured cotton (nor- mally-lightly soiled items).	Main wash Rinses Max. final spin at 1600 rpm	7 kg 3.5 kg <sup>1)</sup>	Spin No Spin Rinse Hold Economy <sup>2)</sup> Super Quick Prewash Easy Iron Extra Rinse	 <sup>3)</sup>  
SYNTHETICS 60°-40°-30°- Cold	Synthetic or mixed fabrics: underwear, coloured garments, non-shrink shirts, blouses.	Main wash Rinses Max. final spin at 900 rpm	3.5 kg 2 kg <sup>1)</sup>	Spin No Spin Rinse Hold Economy <sup>2)</sup> Super Quick Prewash Easy Iron Extra Rinse	 <sup>3)</sup>  
DELICATES 40°-30°-Cold	Delicate fabrics: for example curtains.	Main wash Rinses Max. final spin at 700 rpm	3.5 kg 2 kg <sup>1)</sup>	No Spin Rinse Hold Super Quick Prewash Extra Rinse	 <sup>3)</sup>  
HANDWASH 30°-Cold	Special programme for delicate fabrics with «hand washing» care symbol.	Main wash Rinses Max. final spin at 900 rpm	2 kg	Spin No Spin Rinse Hold	 <sup>3)</sup> 

Programme/ Temperature	Type of laundry	Cycle Description	Max. Load Red. Load <sup>1)</sup>	Available Options	Detergent Compartment
WOOL 40°	Special programme for wool garments bearing the «Pure new wool, non-shrink, appliance washable» label.	Main wash Rinses Max. final spin at 900 rpm	2 kg	Spin No Spin Rinse Hold	
JEANS 40°	With this programme it is possible to wash items like pants, shirts or jackets in denim and also jersey realized with hi-tech materials.	Main wash Rinses Max. final spin at 900 rpm	3.5 kg	Spin No Spin Rinse Hold Prewash Extra Rinse <sup>4)</sup>	
SOAK <sup>5)</sup> 30°	Special programme for heavily soiled laundry. The appliance performs a soak at 30° C. At the end of this time the appliance will stop automatically with water left in the tub. Before starting a new washing programme, drain the water.	Prewash Soak for about 40 minutes Stop with water in the tub	7 kg		
RINSES	With this programme it is possible to rinse and spin cotton garments which have been washed by hand. The appliance performs some rinses, followed by a final long spin. The spin speed can be reduced.	Rinses Max. final spin at 1600 rpm	7 kg	Spin No Spin Rinse Hold Easy Iron Extra Rinse	
DRAIN	For emptying out the water of the last rinse in programmes with the Rinse Hold option selected.	Draining of water	7 kg		



Programme/ Temperature	Type of laundry	Cycle Description	Max. Load Red. Load <sup>1)</sup>	Available Options	Detergent Compartment
SPIN	Separate spin for hand washed garments and after programmes with the Rinse Hold option selected. You can choose the spin speed by pressing the relevant button to adapt it to the fabrics to be spun.	Max. final spin at 1600 rpm	7 kg	Spin	

1) If you select the SUPER QUICK option, we recommend you, to reduce the maximum load as indicated. (Red. load = reduced load). Full loading is possible however with somewhat reduced cleaning results.

2) This option is not active at a temperature lower than 40° C.

3) If using liquid detergents, a programme without PREWASH must be selected.

4) The EXTRA RINSE option will be activated automatically.

5) Refer to the detergent dispenser drawer paragraph to pour the detergent for soak programme.

## Consumption values

Programme	Energy consumption (KWh)	Water consumption (litres)	Programme duration (Minutes) <sup>1)</sup>
White Cottons 90°	2.1	62	<b>For the duration of the programmes, please refer to the display on the control panel.</b>
Cottons 60°	1.35	58	
Cottons 60° + <b>ECONOMY</b> <sup>2)</sup>	1.05	45	
Cottons 40°	0.75	58	
Synthetics 40°	0.55	51	
Delicates 40°	0.55	63	
Wool/ Handwash 30°	0.25	58	

1) Without prewash option selected.

2) «Cottons + Economy» at 60°C with a load of 7 kg is the reference programme for the data entered in the energy label, in compliance with CEI 456 standards.

**i** The consumption data shown on this chart is to be considered purely indicative, as it may vary depending on the quantity and type of laundry, on the inlet water temperature and on the ambient temperature.

**Care and cleaning**

**⚠ Warning!** Switch the appliance off before you carry out any cleaning or maintenance work.

**Maintenance Wash**

With the use of low temperature washes it is possible to get a build up of residues inside the drum.

We recommend that a maintenance wash be performed on a regular basis.

To run a maintenance wash:

- The drum should be empty of laundry.
- Select the hottest cotton wash programme.
- Use a normal measure of detergent, must be a powder with biological properties.

**Cleaning the dispenser drawer and the drawer recess**

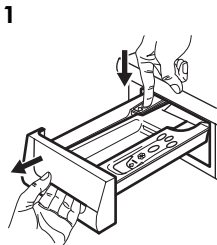

To remove the drawer, press the catch downwards and pull it out.

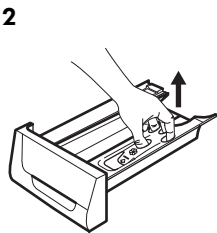

To aid cleaning, remove also the top part of the additive compartment.

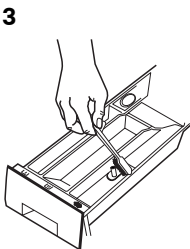

Use a stiff brush to clean and remove all washing powder residue.

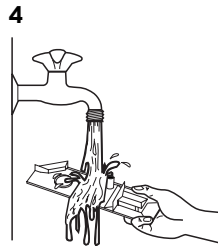

Flush out all the removed parts of the dispenser drawer under a tap to remove any traces of accumulated powder.

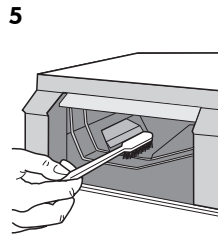

Use the previous brush to clean the recess, ensuring that upper and lower part of it is well cleaned. After having cleaned the dispenser and the drawer recess, replace it and run a rinse programme without any laundry in the drum to flush away any residue.

**Cleaning the pump**

Proceed as follows:

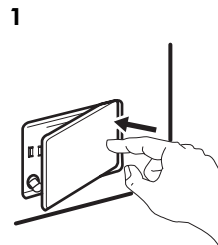

Open the pump door.

2

Place a container close to the pump, to collect any spillage.

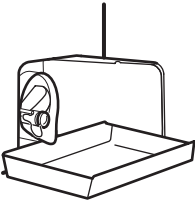

3

Pull out the emergency emptying hose, place it in the container and remove its cover cap.

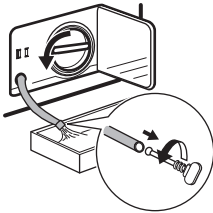

4

When no more water comes out, unscrew the pump cover and remove it. Always keep a rag nearby to dry up spillage of water when removing the pump.

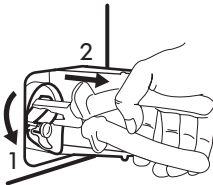

5

Remove any objects from the pump impeller by rotating it.

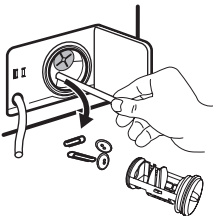

6

Use a pencil to check whether the pump wheel right at the back of the pump housing can turn. (It is normal for the pumping wheel to turn jerkily.) If the pumping wheel cannot be turned, please contact the After Sales Service.

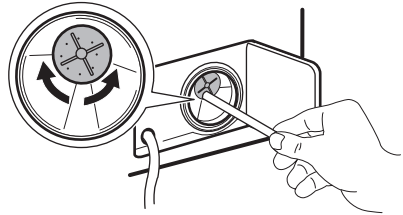

7

Put the cap back on the emergency emptying hose and place the latter back in its seat. Screw the pump fully in.

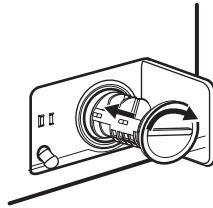

8

Close the pump door.

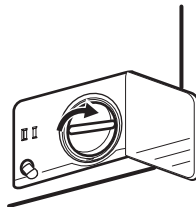

**Cleaning the water inlet filters**

If the appliance takes long to fill with water or doesn't fill, the starting button indicator light blinks in red. Check if the water inlet filters are blocked (see chapter "What to do if..." for more details).

Proceed as follows:

1

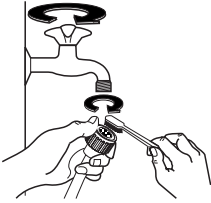

- Turn off the water tap.
- Unscrew the hose from the tap.
- Clean the filter in the hose with a stiff brush.
- Screw firmly the inlet hose back onto the tap.

2

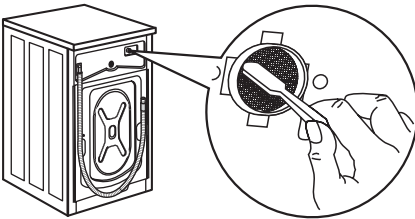

- Unscrew the hose from the appliance. Keep a rag nearby because some water may flow.
- Clean the filter in the valve with a stiff brush or with the piece of cloth.

3

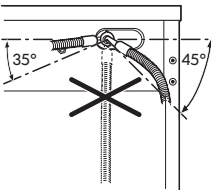

- Screw the hose back to the appliance turning it to the left or the right to suit the installation. Tight the locknut correctly to prevent water leaks.
- Turn on the water tap.

**The dangers of freezing**

If the appliance is exposed to temperatures below 0°C, certain precautions should be taken.

- Turn off the water tap.
- Unscrew the inlet hose.
- Place the end of the emergency emptying hose and that of the inlet hose in a bowl placed on the floor and let water drain out.
- Screw the water inlet hose back on and re-position the emergency emptying hose after having put the cap on again.
- When you intend to start the appliance up again, make sure that the room temperature is above 0°C.

**Emergency emptying out**

If the water is not discharged, proceed as follows to empty out the appliance:

- pull out the plug from the power socket;
- close the water tap;
- if necessary, wait until the water has cooled down;
- open the pump door;
- place a bowl on the floor and place the end of the emergency emptying hose into the bowl. Remove its cap. The water should drain by gravity into the bowl. When the bowl is full, put the cap back on the hose. Empty the bowl. Repeat the procedure until water stops flowing out;
- clean the pump if necessary as previously described;
- replace the emergency emptying hose in its seat after having plugged it;
- screw the pump cover again and close the door.

**What to do if...**

The start of the appliance does not occur or it stops during operation. First try to find a solution to the problem (refer to the table). If not, contact the service centre.

**With some problems, the acoustic signals operate and the display shows an alarm code:**

- **E10** - The appliance does not fill with water.
- **E20** - The appliance does not drain the water.
- **E40** - The appliance door is open or not closed correctly.

 **Warning!** Switch off the appliance before you do the checks.

Problem	Possible cause	Solution
The appliance does not fill:	The water tap is closed.	Open the water tap.
	The inlet hose is squashed or kinked.	Check the inlet hose connection.
	The filter in the inlet hose or the inlet valve filter are blocked.	Clean the water inlet filters. (See "Cleaning the water inlet filters" for more details).
	The water tap is blocked or is furred with limescale.	Clean the water tap.
	The connection of the water inlet hose is not correct.	Check the inlet hose connection.
	The water pressure is too low.	Contact your local water authority.
	The door is not properly closed.	Close the door firmly.
The appliance does not drain the water:	The drain hose is squashed or kinked.	Check the drain hose connection.
	The drain filter is clogged.	Clean the drain filter.
	The connection of the drain hose is not correct.	Check the drain hose connection.
	An option or a programme that ends with the water still in the tub or a that eliminates all the spinning phases has been selected.	Select the draining or spinning programme.
The appliance door is open or not closed correctly.		Close the door firmly.
The appliance does not start:	The plug is not properly inserted in the power socket.	Insert the plug into the power socket.
	There is no power at the socket.	Please check your domestic electrical installation.
	The main fuse or the fuse in a plug has blown.	Replace the fuse.
	The programme selector dial is not correctly positioned and the button <b>5</b> has not been pressed.	Please turn the selector dial and press the button <b>5</b> again.
	The delay start has been selected.	If the laundry are to be washed immediately, cancel the delay start.
	The Child Lock function is activated.	Deactivate the Child Lock function.

Problem	Possible cause	Solution
The appliance spinning phase starts late or does not start:	The electronic unbalance detection device has cut in because the laundry is not evenly distributed in the drum. The laundry is redistributed by reverse rotation of the drum. This may happen several times before the unbalance disappears and normal spinning can resume. If, after 10 minutes, the laundry is still not evenly distributed in the drum, the appliance will not spin.	Redistribute the load manually or load more laundry and select the spin programme.
There is water on the floor:	Too much detergent or unsuitable detergent (creates too much foam) has been used.	Reduce the detergent quantity or use another one.
	Check whether there are any leaks from one of the inlet hose fittings. It is not always easy to see this as the water runs down the hose; check to see if it is damp.	Check the water inlet hose connection.
	The drain or inlet hose is damaged.	Replace it with a new one (check with the After Sales Service the right spare part number).
	The cap on the emergency emptying hose has not been replaced or the filter has not been properly screwed in after cleaning action.	Refit the cap on the emergency emptying hose or screw the filter fully in.
The door will not open:	The washing programme is still running.	Wait the end of washing programme.
	The door lock has not been released.	Wait a few minutes until the door indicator light goes off.
	There is water in the drum.	Select drain or spin programme to empty out the water.
The appliance produces an unusual noise	The transit bolts and packing have not been removed.	Check the correct installation of the appliance.
	The support feet have not been adjusted	Check the correct levelling of the appliance.
	The drain pump could be blocked.	Check the drain pump. (See "Cleaning the pump" for more details).
Unsatisfactory washing results:	Too little detergent or unsuitable detergent has been used.	Increase the detergent quantity or use another one.
	Stubborn stains have not been treated prior to washing.	Use commercial products to treat the stubborn stains.

Problem	Possible cause	Solution
	The correct temperature was not selected.	Check if you have selected the correct temperature.
	Excessive laundry load.	Reduce the laundry load in accordance to the "Washing Programmes table".

After the check, switch on the appliance and press the button 5 to restart the programme. If the malfunction shows again, contact your After Sales Service.

The necessary data for the service centre is on the rating plate. We recommend that you write the data here:

Model description (MOD): .....

Product number (PNC): .....

Serial number (S.N.): .....

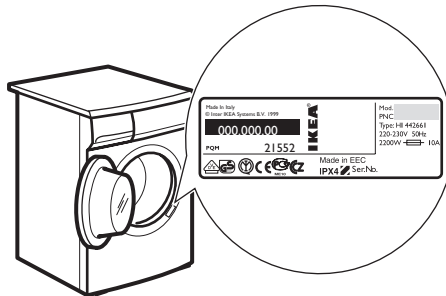

### Technical data

Dimensions	Width (cm)	59,6
	Height (cm)	84,5
	Depth (cm)	63,6 max.
Water supply pressure <sup>1)</sup>	Minimum Maximum	0,5 bar (0,05 MPa) 8 bar (0,8 MPa)
Cotton max. load (kg)	7	
Max. spin speed (rpm)	1600	
Energy class	A++	
Washing class	A	
Spinning class	A	
Washing noise (dB(A))	55	
Spinning noise (db(A))	79	
Average annual energy consumption (kWh) <sup>2)</sup>	210	

Average annual water consumption (litres) <sup>2)</sup>	9000
---	------

1) If the pressure in your area is lower or higher, please contact your After Sales Service.  
 2) The data is based on the washing programme for test institutes assuming 200 cycles per a year.

**i** Information on the electrical connection, voltage and overall power is given on the rating plate, on the inner edge of the appliance door.

## Installation

**⚠ Caution!** Refer to the assembly instructions, in order to proceed with the installation.

**⚠ Warning!** Make sure that mains plug is disconnected from the mains socket during installation.

If a repair is necessary, the appliance must be easily accessible for the engineer. Put the appliance adjacent to a water tap and a drain.

### Water inlet

1

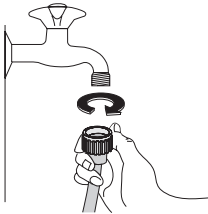

Connect the hose to a tap with 3/4" thread.

2

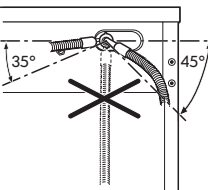

Turn the inlet hose to the left or the right to suit the installation. Tight the locknut correctly to prevent water leaks.

**⚠ Caution!** Do not place the inlet hose downwards.

**i** The inlet hose must not be lengthened. If it is too short and you do not wish to move the tap, you will have to purchase a new, longer hose specially designed for this type of use.

### Water drainage

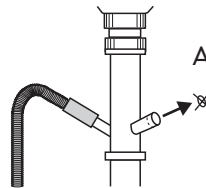

If you connect the water drain hose to a water trap under the sink, remove the plastic membrane (A). If you do not remove the membrane, detergent residue and clothes fluff can cause a blockage in the drain hose spigot.

**⚠ Caution!** Make sure that the water couplings are tight to prevent water leakage.

**i** The drain hose may be extended to a maximum of 4 metres. An additional drain hose and joining piece is available from your local Service Centre.

## Electrical connection

- The appliance must be earthed.
- Make sure that the electrical information on the rating plate agree with your domestic power supply.



- Always use a correctly installed shockproof socket.
- Do not use multi-way plugs, connectors and extension cables. There is a risk of fire.
- Do not replace or modify the mains cable yourself. Contact the After Sales Service.
- Make sure that the mains plug and cable is not squashed or damaged by the back of the appliance.
- Make sure that the mains plug is accessible after installation.
- Do not pull the mains cable to disconnect the appliance. Always pull the mains plug.
- This appliance complies with the E.E.C. Directives.



**⚠ Warning!** The appliance is supplied with a 13 amp plug attached. Use a 13 amp ASTA approved (BS 1362) fuse if it is necessary to change the fuse in the plug supplied. A cut off plug inserted into a 13 amp socket is a serious safety danger. Make sure that it is disposed of safely.

## Environment concerns

The symbol  on the product or on its packaging indicates that this product may not be treated as household waste. Instead it should be taken to the appropriate collection point for the recycling of electrical and electronic equipment. By ensuring this product is disposed of correctly, you will help prevent potential negative consequences for the environment and human health, which could otherwise be caused by inappropriate waste handling of this product. For more detailed information about recycling of this product, please contact your local council, your household waste disposal service or the shop where you purchased the product.

## Packaging materials

The materials with the symbol  are recyclable. Dispose the packaging in a suitable collection containers to recycle it.

## Disposal of the appliance

- To prevent the risk of physical injury or damage:
  - Disconnect the mains plug from the mains socket.
  - Cut off the mains cable and discard it.
  - Discard the door catch. This prevents children or small animals from being closed inside of the appliance. There is a risk of suffocation.

## IKEA GUARANTEE

### How long is the IKEA guarantee valid?

This guarantee is valid for five (5) years from the original date of purchase of Your appliance at IKEA, unless the appliance is named LAGAN in which case two (2) years of guarantee apply. The original sales receipt is required as proof of purchase. If service work is carried out under guarantee, this will not extend the guarantee period for the appliance,

### Which appliances are not covered by the IKEA five (5) years guarantee?

The range of appliances named LAGAN and all appliances purchased in IKEA before 1st of August 2007

### Who will execute the service?

IKEA service provider will provide the service through its own service operations or authorized service partner network.

### What does this guarantee cover?

The guarantee covers faults of the appliance, which have been caused by faulty construction or material faults from the date of purchase from IKEA. This guarantee applies to domestic use only. The exceptions are specified under the headline "What is not covered under this guarantee?" Within the guarantee period, the costs to remedy the fault e.g. repairs, parts, labour and travel will be covered, provided that the appliance is accessible for repair without special expenditure. On these conditions the EU guidelines (Nr. 99/44/EG) and the respective local regulations are applicable. Replaced parts become the property of IKEA.

### What will IKEA do to correct the problem?

IKEA appointed service provider will examine the product and decide, at its sole discretion, if it is covered under this guarantee. If considered covered, IKEA service provider or its authorized service partner through its own service operations, will then, at its sole discretion, either repair the defective product or replace it with the same or a comparable product.

### What is not covered under this guarantee?

- Normal wear and tear.
- Deliberate or negligent damage, damage caused by failure to observe operating instructions, incorrect installation or by connection to the wrong voltage, damage caused by chemical or electro-chemical reaction, rust, corrosion or water damage including but not limited to damage caused by excessive lime in the water supply, damage caused by abnormal environmental conditions.
- Consumable parts including batteries and lamps.
- Non-functional and decorative parts which do not affect normal use of the appliance, including any scratches and possible color differences.
- Accidental damage caused by foreign objects or substances and cleaning or unblocking of filters, drainage systems or soap drawers.

- Damage to the following parts: ceramic glass, accessories, crockery and cutlery baskets, feed and drainage pipes, seals, lamps and lamp covers, screens, knobs, casings and parts of casings. Unless such damages can be proved to have been caused by production faults.
- Cases where no fault could be found during a technician's visit.
- Repairs not carried out by our appointed service providers and/or an authorized service contractual partner or where non-original parts have been used.
- Repairs caused by installation which is faulty or not according to specification.
- The use of the appliance in a non-domestic environment i.e. professional use.
- Transportation damages. If a customer transports the product to their home or other address, IKEA is not liable for any damage that may occur during transport. However, if IKEA delivers the product to the customer's delivery address, then damage to the product that occurs during this delivery will be covered by this guarantee.
- Cost for carrying out the initial installation of the IKEA appliance. However, if an IKEA service provider or its authorized service partner repairs or replaces the appliance under the terms of this guarantee, the service provider or its authorized service partner will re-install the repaired appliance or install the replacement, if necessary.

This restriction do not apply to fault-free work carried out by a qualified specialist using our original parts in order to adapt the appliance to the technical safety specifications of another EU country.

### How country law applies

The IKEA guarantee gives You specific legal rights, which covers or exceed local demands. However these conditions do not limit in any way consumer rights described in the local legislation

### Area of validity

For appliances which are purchased in one EU country and taken to another EU country, the services will be provided in the framework of the guarantee conditions normal in the new country. An obligation to carry out services in the framework of the guarantee exists only if the appliance complies and is installed in accordance with:

- the technical specifications of the country in which the guarantee claim is made;
- the Assembly Instructions and User Manual Safety Information;

### The dedicated After Sales Service for IKEA appliances:

Please do not hesitate to contact IKEA After Sales Service to:

1. make a service request under this guarantee;
2. ask for clarification on installation of the IKEA appliance in the dedicated IKEA kitchen furniture. The service won't provide clarifications related to:
  - the overall IKEA kitchen installation;
  - connections to electricity (if machine comes without plug and cable), to water and to gas since they have to be executed by an authorized service engineer.
3. ask for clarification on user manual contents and specifications of the IKEA appliance.

To ensure that we provide you with the best assistance, please read carefully the Assembly Instructions and/or the User Manual section of this booklet before contacting us.

### How to reach us if You need our service



Please refer to the last page of this manual for the full list of IKEA appointed contacts and relative national phone numbers.

**Important!** In order to provide You with a quicker service, we recommend that You use the specific phone numbers listed at the end of this manual. Always refer to the numbers listed in the booklet of the specific appliance You need an assistance for. Before calling us, assure that You have to hand the IKEA article number (8 digit code) for the appliance of which you need our assistance.

**Important! SAVE THE SALES RECEIPT!** It is Your proof of purchase and required for the guarantee to apply. Note that the receipt reports also the IKEA article name and number (8 digit code) for each of the appliances you have purchased.

### Do You need extra help?

For any additional questions not related to After Sales of your appliances, please contact our nearest IKEA store call centre. We recommend you read the appliance documentation carefully before contacting us.

Country	Phone number	Call Fee	Opening time
België	070 246016	Binnenlandse gesprekskosten	8 tot 20 Weekdagen
Belgique		Tarif des appels nationaux	8 à 20. En semaine
България	0700 10 218	Такса за повикване от страната	От 9 до 18 ч в работни дни
Česká republika	246 019721	Cena za místní hovor	8 až 20 v pracovních dnech
Danmark	70 15 09 09	Landstakst	man.-fre. 09.00-20.00 lør. 09.00-16.00 1 søndag pr. måned, normalt første søndag i måneden
Deutschland	01803-334532	(0,09 € / Min.*) * aus dem Festnetz der DTAG; Mobilfunkpreise abweichend	8 bis 20 Werktage
Ελλάδα	211 176 8276	Υπεραστική κλήση	8 έως 20 κατά τις εργάσιμες ημέρες
España	91 1875537	Tarifa de llamadas nacionales	De 8 a 20 en días laborables
France	0170 36 02 05	Tarif des appels nationaux	9 à 21. En semaine
Ireland	0 14845915	National call rate	8 till 20 Weekdays
Ísland	5880503	Innanlandsgjald fyrir síma	9 til 18. Virka daga
Italia	02 00620818	Tariffa applicata alle chiamate nazionali	dalle 8 alle 20 nei giorni feriali
Κυπρος	22 030 529	Υπεραστική κλήση	8 έως 20 κατά τις εργάσιμες ημέρες
Magyarország	061 998 0549	Belföldi díjszabás	Hétköznap 8 és 10 óra között
Nederland	0900 235 45 32 and/or 0900 BEL IKEA	"0,10 EUR/min (niet lokaal) Incl. BTW"	ma-vr 9.00-21.00 zat 9.00-20.00 zon 9.00-18.00
Norge	815 22052	Takst innland	8 til 20 ukedager
Österreich	0810 300486	zum Ortstarif	8 bis 20 Werktage
Polska	012 297 8787	Stawka wg taryfy krajowej	Od 8 do 20 w dni robocze
Portugal	211557985	Chamada Nacional	9 às 21. Dias de Semana *excepto feriados
România	0212121224	Tarif apel național	8 - 20 în zilele lucrătoare
Россия	8 495 6662929	Действующие телефонные тарифы	с 8 до 20 по рабочим дням Время московское
Schweiz	031 5500 324	Tarif für Anrufe im Bundesgebiet	8 bis 20 Werktage
Suisse		Tarif des appels nationaux	8 à 20. En semaine
Svizzera		Tariffa applicata alle chiamate nazionali	dalle 8 alle 20 nei giorni feriali
Slovensko	(02) 3300 2554	Cena vnútroštátneho hovoru	8 až 20 v pracovných dňoch
Suomi	0207 85 1000	Kotimaan puhelun hinta	arkipäivisin 8.00-20.00
Sverige	0775 700 500	lokalsamtal (lokal taxa)	mån-fre 8.30-20.00 lör-sön 9.30-18.00
Türkiye	212 244 0769	Ulusal arama ücreti	Hafta içi saat 09:00'dan 18:00'a kadar
Україна	044 586 2078	Міжміські дзвінки платні	9 - 21 в робочі дні
United Kingdom	020 3347 0044	National call rate	9 till 21. Weekdays







