

OCEAN TV

Satellite Antennas

Ocean Series O37M and O45M
Installation and User Manual
Version 1.34

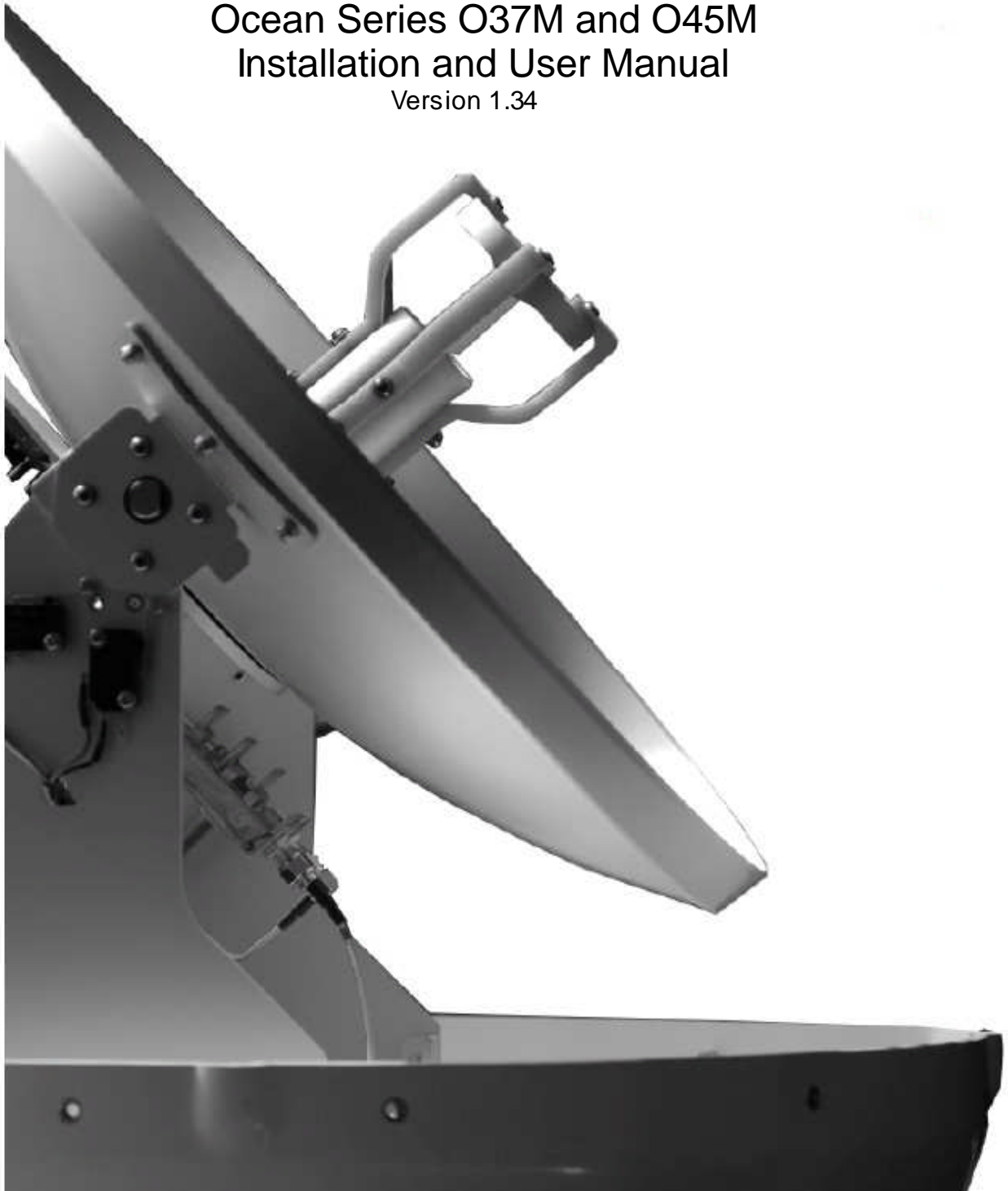

www.oceantv.com.au

© Ocean TV 2010

Antenna System Overview

A complete satellite TV system, illustrated in Figure 1-1, includes the O45M antenna connected to a IDU, a satellite TV receiver, and a television set.

Direct Broadcast Satellite Overview

Direct Broadcast Service (DBS) satellites broadcast audio, video and data information from satellites located 22,000 miles in space. A receiving station, such as the O45M antenna, should include a dish and satellite receiver to receive the signals and process them for use by the consumer audio and video equipment. The system requires a clear view of the satellite to maximize the signal reception.

Objects such as tall lighthouse, bridges and big ship that block this view will cause a loss of signal. The signal will be quickly restored once the antenna has a clear line of sight again. Heavy rain, cloud, snow or ice may also interfere with the signal reception quality. If the satellite signal is lost due to blockage or severe weather condition, services from the receiver will be lost (picture will freeze frame and may disappear). When the satellite signal strength is again high enough, then the receiver will resume providing desired programming services.

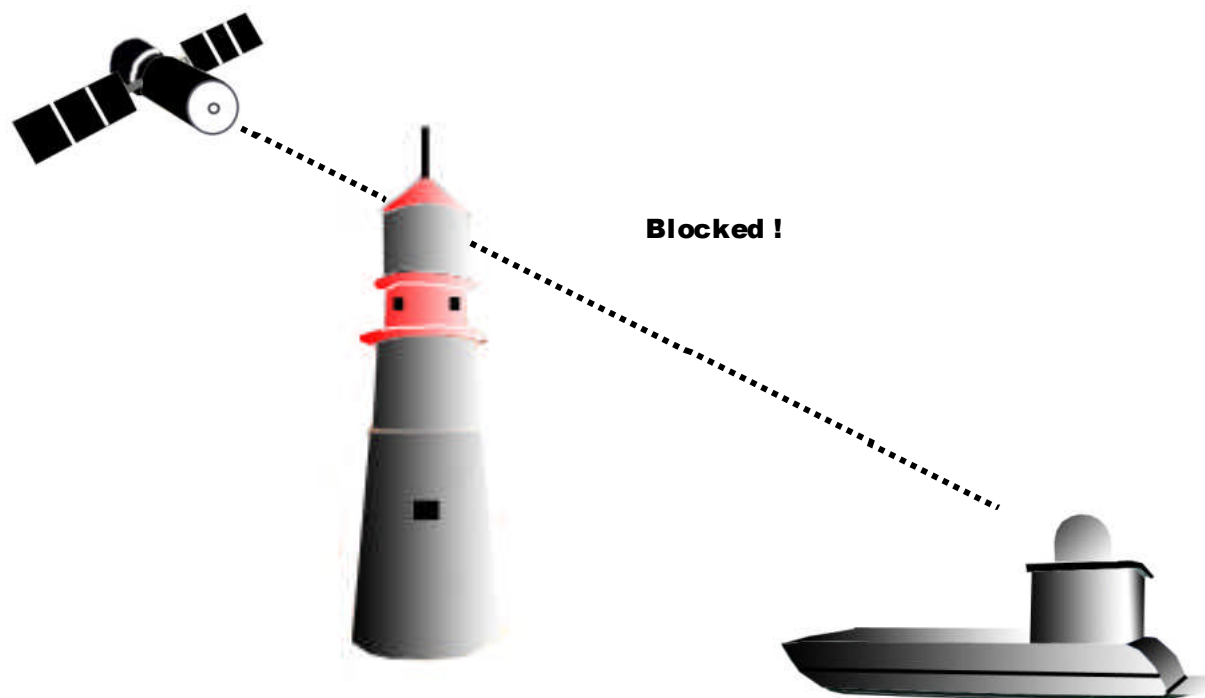

Figure 1-2 Satellite Blockage

System Components



Antenna Unit

The antenna unit houses the antenna positioning mechanism, LNB (low noise block), and control elements within an enclosed weatherproof dome.

Weather tight connectors join the power, signal, and control cabling from the below decks units.



IDU (InDoor Unit)

The IDU is the system's user interface, providing access to the system and its functions through an LCD and three buttons.

The IDU also serves as the vessel's junction box, allowing the system to use vessel power, and supply and receive data to/from the antenna unit.



Satellite Receiver

The Satellite Receiver is a Set Top Box that allows the Satellite Signals to be displayed on the Television.

Satellite Receivers are supplied by the end user or under contract by a Subscription Satellite TV Provider.

Figure 1 – 3 System Components

Ocean O37M	
Antenna Type	Parabola
Frequency Band	Ku Band
Operating Frequency	10.7GHz to 12.75GHz
Dish Dimension	370mm
Radome Dimension	440x430mm
Antenna Weight	9kg
Antenna Gain	31dBi
Minimum EIRP	50dBW
Polarization	V/H or RHCP/LHCP
Type of Stabilization	2-Axis Step Motor
Elevation Range	5° to 90°
Azimuth Range	400°
Tracking Rate	50°/sec
Temperate Range	-20° to 70°
Power	12~24VDC (19w at 12vdc)

Ocean O45M	
Antenna Type	Parabola
Frequency Band	Ku Band
Operating Frequency	10.7GHz to 12.75GHz
Dish Dimension	450mm
Radome Dimension	550x580mm
Antenna Weight	15kg
Antenna Gain	33dBi
Minimum EIRP	49-48dBW
Polarization	V/H or RHCP/LHCP
Type of Stabilization	2-Axis Step Motor
Elevation Range	5° to 90°
Azimuth Range	400°
Tracking Rate	50°/sec
Temperate Range	-20° to 70°
Power	12~24VDC (24w at 12vdc)
Auto Skew Range	-90° to 90°

Antenna System Overview

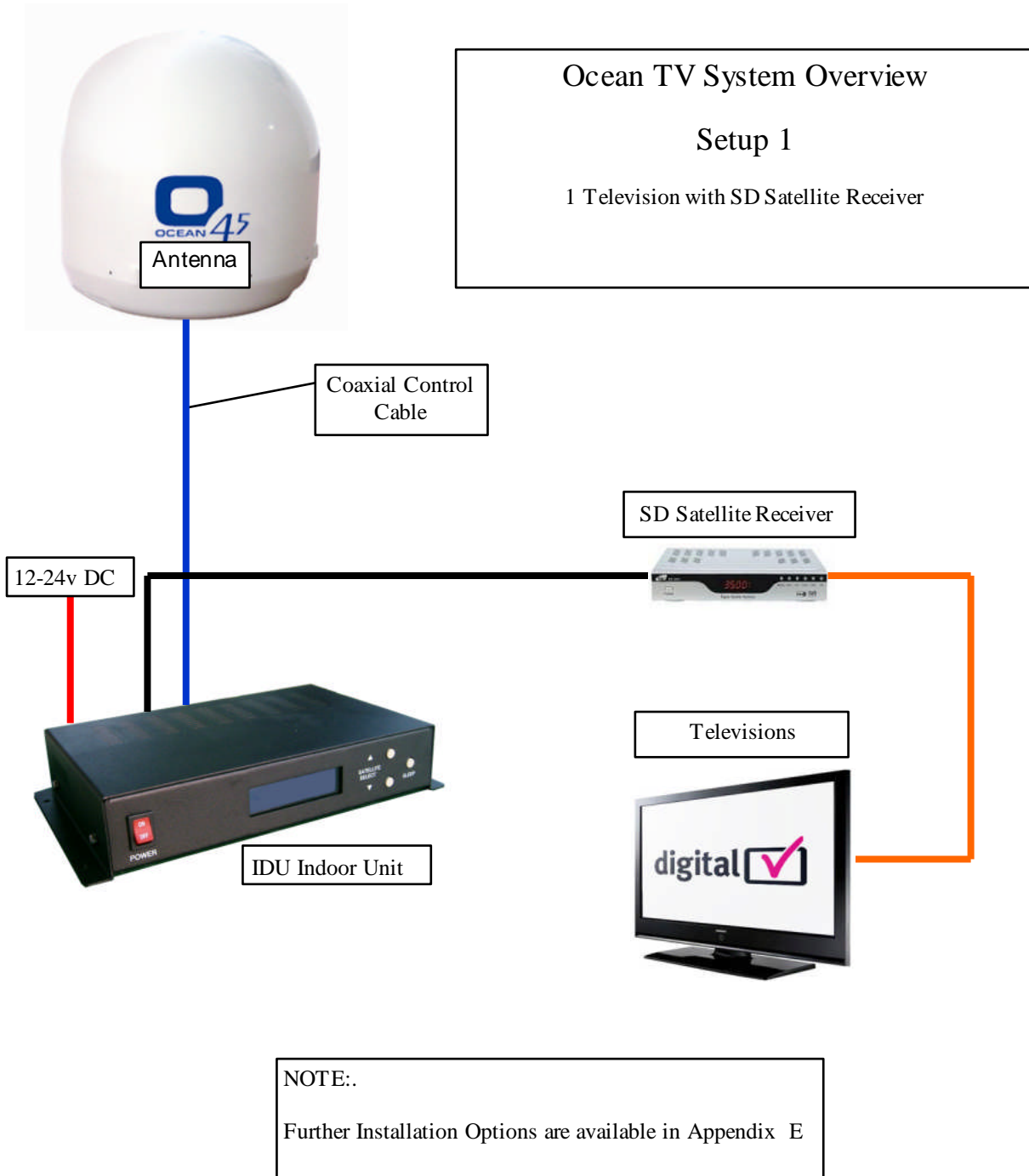

Figure 1 –1 System Diagram

Contents

1 Introduction	
Specification.....	4
Antenna System Overview.....	5
Direct Broadcast Satellite Overview.....	6
System Components.....	7
2 Installation	
Unpacking the Unit.....	9
Preparing for the installation.....	10
Selecting the location.....	11
Equipment and cable installation.....	12
Setting the LNB Skew Angle (Manual Skew version only).....	13
3 Operation	
Receiving Satellite TV Signals.....	15
Turning the System On/Off.....	16
Changing Channels.....	17
Watching TV.....	17
Switching between Satellites.....	17
Operating the IDU.....	18
Choosing the Correct Satellite to Track.....	19
4 Troubleshooting	
Simple Check.....	21
Causes and Remedies.....	22
i Appendix A	
How to set the skew angle.....	23
ii Appendix B	
Satellite Coverage Map.....	26
iii Appendix C	
Firmware Upgrade.....	27
iv Appendix D	
O37M Antenna Drawing.....	31
O45M Antenna Drawing.....	32
v Appendix E	
System Diagrams.....	33
vi Appendix F	
Satellite Coverage Maps.....	40
5 Accessories	
Installation and User Accessories.....	42

Welcome

Congratulations on purchasing the Ocean TV Marine Satellite Antenna System.

The Ocean Series O37M and O45M satellite antenna system is a innovative and technologically advanced satellite In-Motion system. The O37M/O45M has a unique combination of state-of-the art components with the most sophisticated satellite acquisition and tracking programs to provide the following features:

- Fast satellite acquisition
- Gyro and Signal Stabilised smooth tracking
- Compatible with any Satellite Receiver
- Compatible with all Direct Broadcast Satellites (DBS)
- Built-in Digital Broadcast Receiver (DVB)
- Capable of High Definition receiving
- Multi Output as standard (Foxtel IQ and Austar MyStar Compatible)

Ocean TV Antennas have been designed to be simple to operate and provide years of trouble free performance.

Welcome to the Ocean TV family.

OCEAN TV

Notes, Cautions, and Warnings



Caution - Improper handling by unqualified personnel can cause serious damage to this equipment. Unqualified personnel who tamper with this equipment may be held liable for any resultant damage to the equipment.

Install under DRY condition ONLY. Do not install this system in the rain, or under wet conditions. Moisture may effect the electronics and void warranty.



Warning - Two people are needed to install the antennas onto the roof. Do not try to install the antenna by yourself.

Note - Before you begin, carefully read each of the procedures in this manual. If you have not performed similar operations on similar equipment, ***do not attempt*** to perform these procedures.

Installation

This section offers a general explanation of how properly to install the O37M and O45M antenna. Installation of the O37M or O45M antenna must be accomplished by or under the supervision of an authorized dealer for the Limited Warranty to be valid and in force. The steps in the installation and setup process are as follows:

Unpacking the unit.....	9
Preparing for the installation.....	10
Selecting the location.....	11
Equipment and cable installation.....	12



Unpacking the unit

1. Open box and remove packing material.

The following items are included in the packaging of the O37M and O45M antenna.

Item	Description	Quantity
1	O37M or O45M Antenna Unit	1 each
2	IDU (In Door Unit)	1 each
3	Power Cable	1 each
4	Coaxial Cable (10m)	1 each
5	Coaxial Cable (1m)	1 each
6	Installation & User Manual	1 set
7	Cable Right Hand Connectors (O37M Only)	1 Set of 6

Note: Optional approved Cables and accessories are available from Ocean TV.

Table 2-1 Parts included

2. Lift dome out of box vertically. Do not turn box and “roll” out, or turn upside down to remove.

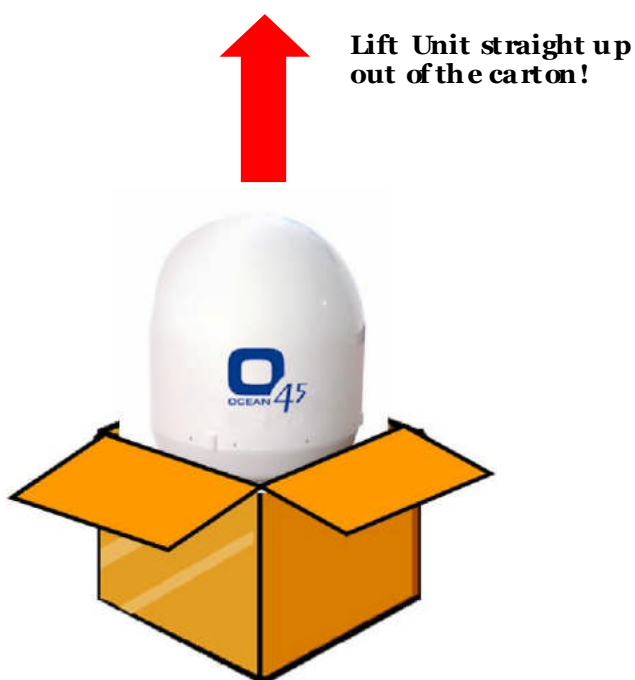

Figure 2-1 Unpacking the unit

Preparing for the installation

Install Tools and Materials

The O37/45M antenna system is designed for simple installation and setup. However, the following list of equipment or items should be available during installation of the O37/45M antenna.

- Electric drill and drill bits
- Socket wrench
- Silicon sealant
- Fastener suitable for specific application

1. Verification of the Vessel's Power Supply.

- Confirm that the vessel's power supply is 12VDC~24VDC.

2. Verification of the Satellite Receiver and IDU's attachment and the electricity supply

- Attach Satellite Receiver and IDU in the interior of the vessel or the trunk.
- Connect the power of Satellite Receiver and IDU.
- Once the power of Satellite Receiver and IDU is verified, it confirms that both Satellite Receiver and IDU are working normally.

3. Procedure of the satellite's attachment and installation.

- Attach the satellite on the flat surface area of the vessel's roof.
- Connect each end of the Coaxial antenna cable to the satellite's terminal and the IDU.
- Connect the IDU and the Satellite Receiver box together through the coaxial cable.
- Make sure that the satellite is working normally, once the power is supplied.



Warning : Things to consider when installing the antenna.

- **Turn off the power** when attaching or detaching the antenna.
- Make sure that the attached satellite is fixed **on the flat surface**.
- When attaching, ensure that all the products are adhered properly.
- Ensure that all the cables are connected properly.

Selecting the location

Determine the optimum mounting location for the antenna radome assembly. It should be installed where :

1. The antenna has a clear line-of-sight view to as much of the sky as is practical. Choose a location where masts or other structures do not block the satellite signal from the dish as the vessel turns.
2. The antenna is at least 5 feet away from other transmitting antennas (HF, VHF and radar) that may generate signals that may interfere with the O37/45M antenna. The further away the O37/45M antenna is from these other antennas, the less impact their operation will have on it.
3. Direct radiation into the antenna from vessels radar, especially high power surveillance radar arrays, is minimized. The radome should be as far away from the vessels Radar as possible and should NOT be mounted on the same plane as the vessels Radar.
4. The antenna radome assembly should be rigidly mounted to the vessel. If necessary, reinforce the mounting area to assure that it does not flex due to the vessel motion or vibration.

If these conditions cannot be entirely satisfied, the site selection will inevitably be a “best” compromise between the various considerations.

Perform a through site inspection on the roof for the antenna to be mounted.

1. The antenna must have a clear view of the sky and the horizon at all the directions to avoid blockage of the satellite signal.
2. The antenna should be on the top of the vessel.

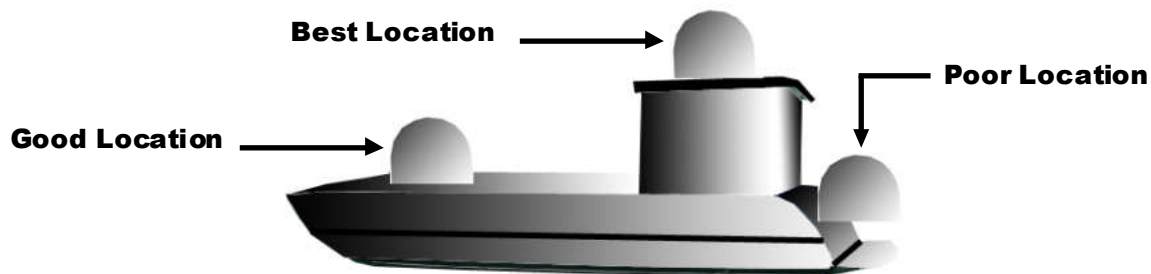

Figure 2-2 Selecting the location

Equipment and cable installation

This offers a general explanation of how to install the IDU and satellite receiver properly to the inside of vessel connecting with coaxial cable.

1. The Coaxial cable is routed from the antenna to the IDU inside the vessel.
2. After Once deciding where to place the IDU and satellite receiver, make sure that both units are placed in a dry and protected area.
3. The IDU and satellite receiver should be placed away from any heat source and in an area with proper ventilation.
4. Ensure that there are at least 3cm of space around both units for ventilation and connection of cables. **Do not stack the units on top of each other.**
5. The following describes the basic wiring configurations for the O45M antenna system.
 - Connect the Coaxial cable to the O37/45M antenna port on the back of the IDU
 - Connect one end of the supplied coaxial cable to the receiver port on the back of the IDU
 - Connect the other end of the coaxial cable to the satellite receiver



Setting the LNB skew angle (O37M Antenna Only)

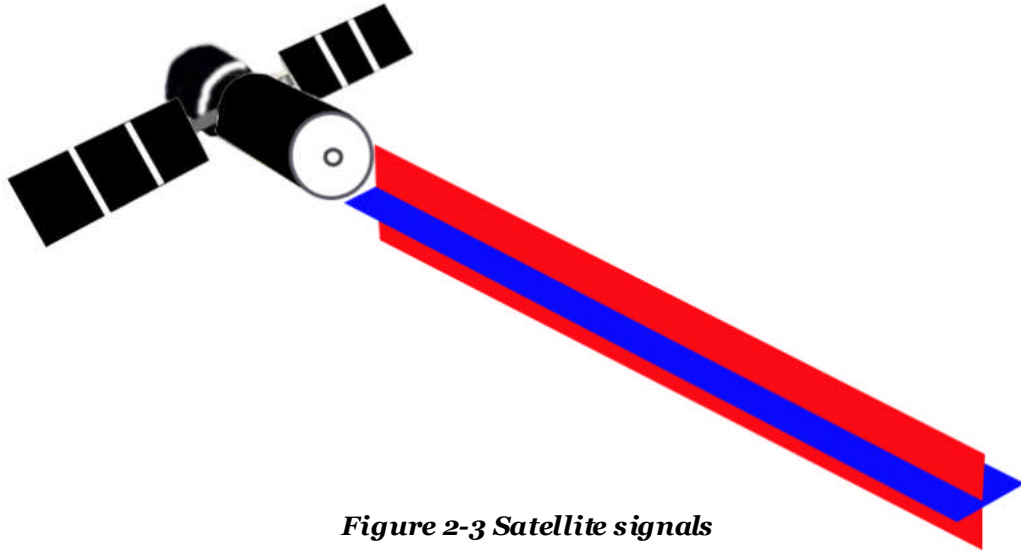

Figure 2-3 Satellite signals

Signals transmitted in vertical (red) and horizontal (blue) wave offset exactly 90° from each other. Since linear satellite signals are oriented in a precise cross pattern, the O45M antenna’s receiving element, called an LNB (low-noise block) must be oriented in the same way to optimize reception. This orientation adjustment is referred to as the LNB’s “skew angle.” **Figure 2-4** illustrates how skew determines the amount of signal the LNB collects. The more signal, the better the reception.

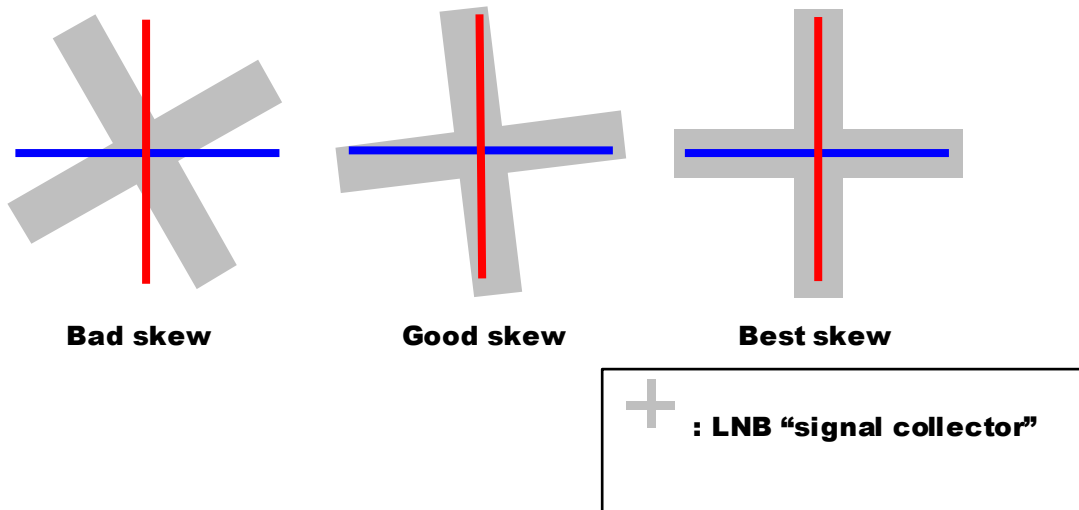

Figure 2-4 Best Skew Angle

The correct skew setting varies depending on your geographic location, since the orientation of your antenna to the satellite changes as you move. For complete details about adjusting the LNB’s skew angle, see “Appendix A– How to Set the Skew Angle”

All Ocean O37M Skew Angles are preset for Australian East Coast or New Zealand

Operation

The O37M/O45M antenna system is easy to use. Under normal conditions, operation of the O37M/O45M antenna requires no intervention from the user. Antenna unit initialization and satellite acquisition is completely automatic.

Receiving Satellite TV Signal.....	15
Turning the System On/Off.....	16
Changing Channels.....	17
Watching TV.....	17
Switching between Satellites.....	17
Operating the IDU.....	18



Receiving Satellite TV Signals

Television satellites are located in fixed positions above the Earth's equator and beam TV signals down to certain regions of the planet. To receive TV signals from a satellite, you must be located within that satellite's unique coverage area. To check it, see "Appendix B – Satellite Coverage Map" In addition, since TV satellites are located above the equator, the O37/45M antenna must have a clear view of the sky to receive satellite TV signals. Anything that stands between the antenna and the satellite can block the signal, resulting in lost reception. Common causes of blockage include lighthouses, boat masts, trees, buildings, and bridges. Heavy rain, ice, or snow might also temporarily interrupt satellite signals.

Turning the System On/Off

Since power to the O37/45M system is controlled by the IDU, you can turn the antenna on or off by applying/removing operating power to the IDU.

IMPORTANT

It is important to following the following steps in the correct order.

Failure to do so may lead to the satellites not being tracked correctly, or not tracking at all.

□

Turning on the System

Follow the steps below to turn on your O37M/45M System.

1. Make sure the antenna has a clear view of the sky.
2. Apply operating power to the IDU.
3. Wait one minute for system startup. The IDU will display the Tracking Satellite screen after system testing is complete.
4. Turn on the Satellite TV Receiver Set Top Box (Provided by your Pay TV Provider)

Turning off the System

Follow the steps below to turn off your O37/45M System.

1. Remove operating power from the IDU.
2. Turn off your satellite TV receiver and TV.

Auto-Sleep

Both the O37M and O45M have an auto sleep mode,. This mode is fully automatic and will usually happen at the dock after 10 minutes of no movement of the vessel. Occasionally, when the antenna comes out of auto sleep due to vessel movement, the satellite signal may be interrupted for a few seconds while the antennas starts tracking the correct satellite again.

Changing Channels

If you have followed the installation instructions, your system should be set to the satellite of your choice and the system should have downloaded the appropriate channel guides. When the O37M/O45M antenna system and satellite receiver is properly configured, it is easy to change the channel using the remote control that normally comes with the receiver unit.

Watching TV

The O37/45M antenna is designed to operate as efficiently and as reliably as possible when the vessel is moved and anchored. It is also the quickest satellite acquisition system available among the O37/45M antennas. If you have anchored the vessel and the antenna has completed searching selected satellite, turn off IDU Power to avoid unnecessary use of power. Because the LNB receives its power from the Satellite Receiver through the IDU, the antenna will continue to receive the satellite TV signals.

Switching between Satellites

You can switch between satellites using the IDU by pressing Satellite select buttons. Follow the steps below to switch to another satellite.

1. Ensure that the LCD screen of the IDU is displayed.

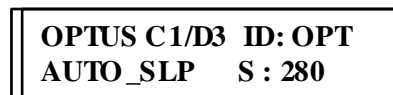

Figure 3-1 IDU LCD Screen

2. Press the Satellite select buttons to switch to another satellite.
3. The antenna shifts to track selected satellite. Wait for the Tracking Satellite screen to reappear with the ID of selected satellite displayed.

Australia Systems are setup for Optus Satellites C1 and D3 as standard.

Optus C1 and D3 are for use with Foxtel, Austar, Optus Aurora, VAST
 Intelsat 8 is for Select TV (No longer Available in Australia)

New Zealand Systems are setup for Optus D1

Optus D1 are for use with FreeView NZ and Sky NZ

Operating the IDU

Appearance

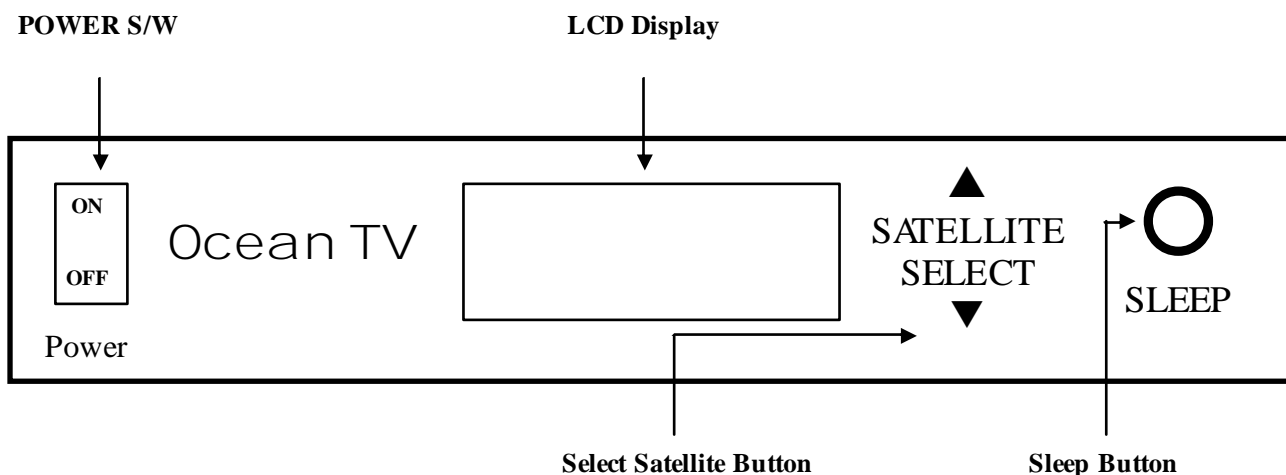

Figure 3-2 Appearance of IDU

Functions of LCD Display

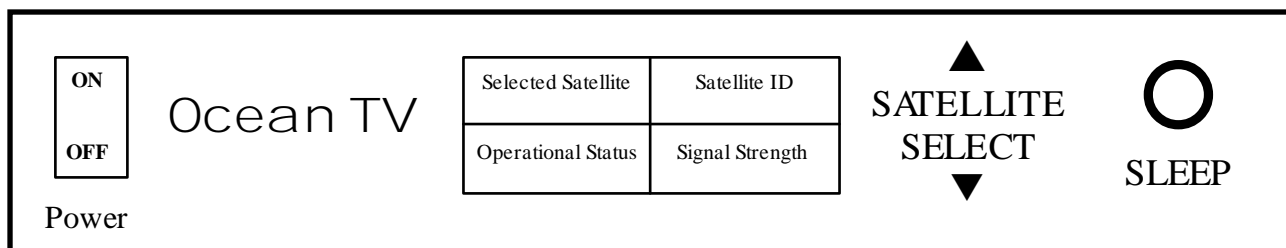
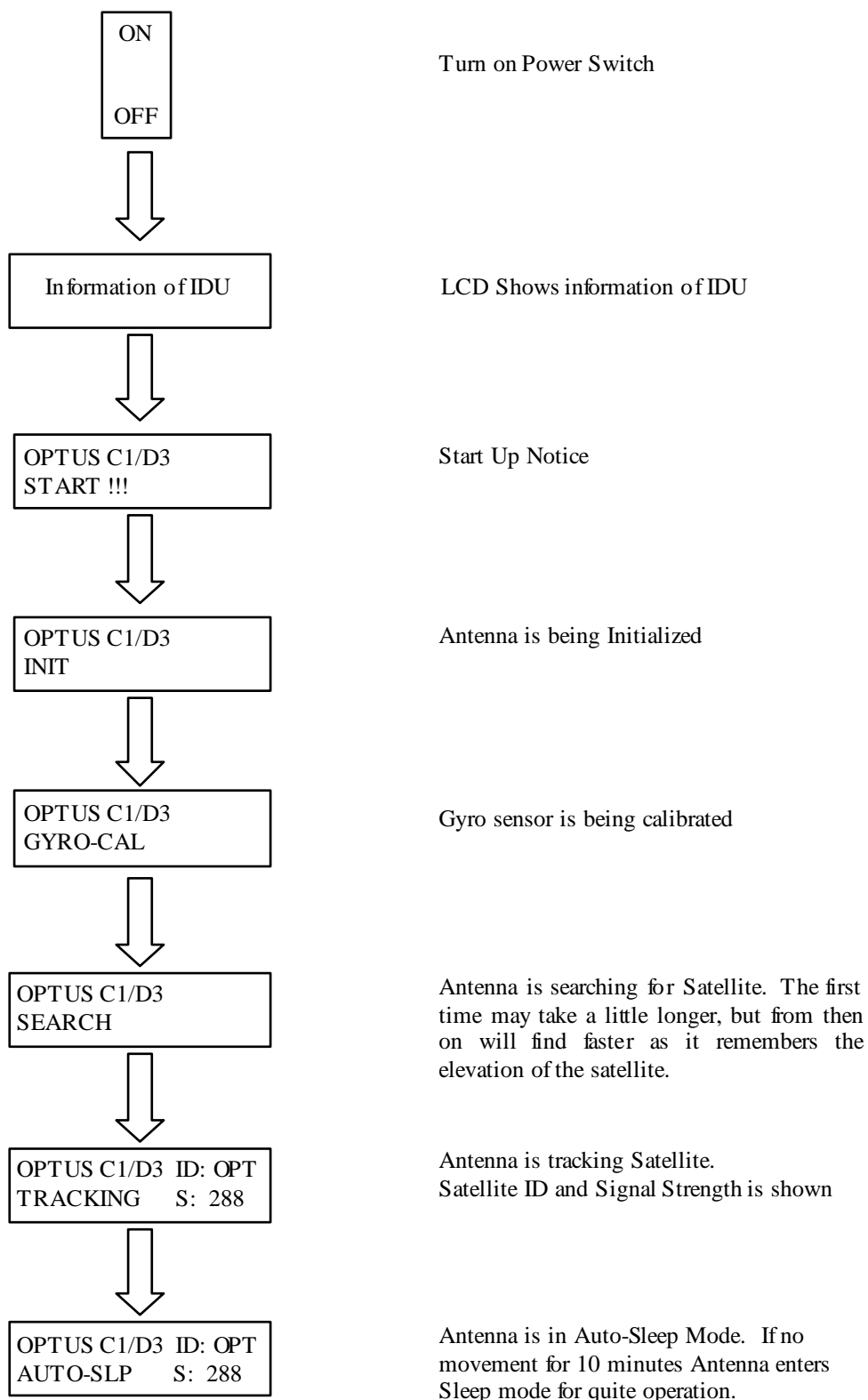

Figure 3-3 Functions of LCD Display

Explanation of words in LCD

- INIT : It shows condition of initializing the antenna.
- INIT-SCH : It shows condition of initial search mode.
- SAT-MOVE: It shows condition of moving to another satellite.
- S:xxx : It shows intensity of signal.
- ID:xxx : It shows ID of acquired satellite.
- GYRO-CAL : It shows condition of calibrating the Gyro Sensor.

General Operation



In case of Search Failure

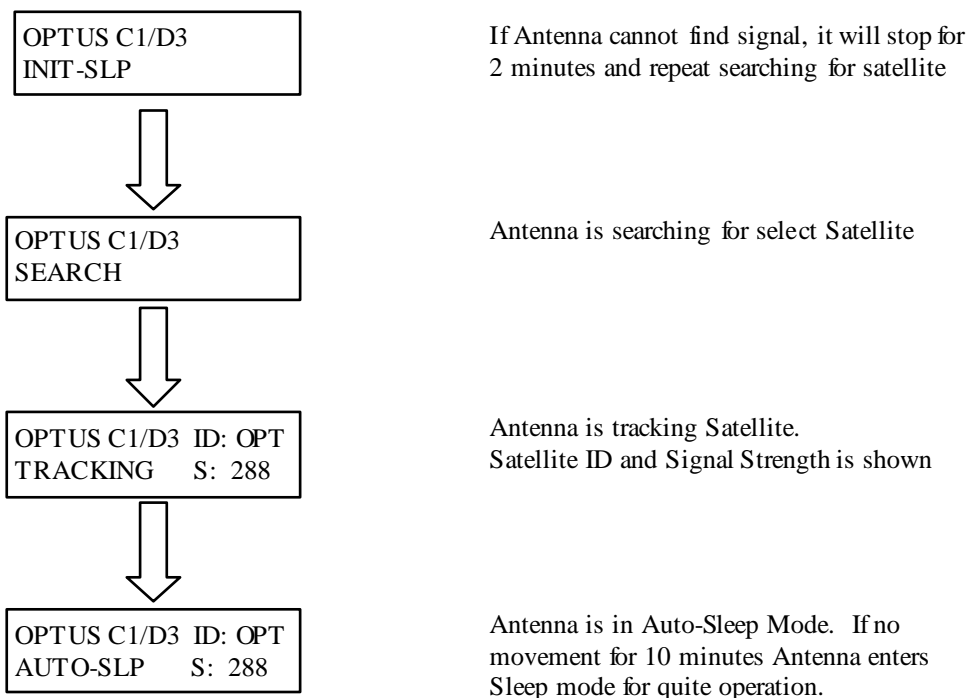

Selecting Correct Satellite

Use the Select Satellite buttons to chose the Satellite to receive. On start up, the system will default to the last selected Satellite.

Australia

Foxtel	OPTUS C1/D3
Austar	OPTUS C1/D3
Select TV	Intelsat 8
OPTUS Aurora	OPTUS C1/D3
VAST	OPTUS C1/D3

New Zealand

FreeView NZ	OPTUS D1-NZ
Sky TV NZ	OPTUS D1-NZ

Trouble Shooting

There are a number of common issues that can affect the signal quality or the operation of the O45M antenna system. The following sections address these issues and potential solutions.

Simple check.....	21
Causes and Remedies.....	22



Simple check

Can the antenna see the satellite?

The antenna requires an unobstructed view of the sky to receive satellite TV signals. Common causes of blockage include trees, buildings, bridges, and mountains.

Is there excessive dirt or moisture on the antenna dome?

Dirt buildup or moisture on the dome can reduce satellite reception. Clean the exterior of the dome periodically.

Is it raining heavily?

Heavy rain or snow can weaken satellite TV signals. Reception should improve once the inclement weather subsides.

Is everything turned on and connected properly?

Make sure your TV and receiver are both turned on and set up for the satellite input. Finally, check any connecting cables to ensure none have come loose.

Is the antenna's LNB set to the correct skew angle? (Manual Skew Ver. Only)

To optimize reception, the antenna's LNB needs to be set to the correct skew angle for the satellite you want to track. **See "Appendix A – How to set the skew angle"** for details. Only for Ocean O37M, O45M has Autoskew.

Causes and Remedies

Receiver Fault

Your satellite TV receiver might be set up incorrectly or defective. First check the receiver's configuration to ensure it is set up for the desired programming. In the case of a faulty receiver, refer to your selected receiver's user manual for service and warranty information.

Satellite Coverage Issue

Television satellites are located in fixed positions above the Earth's equator and beam TV signals down to certain regions of the planet (not worldwide). To receive TV signals from a satellite, you must be located within that satellite's unique coverage area. See **"Appendix-B Satellite Coverage Map"**

Satellite Signal Blocked

The O37/45M Antenna needs a clear line of sight (LOS), view to the satellite for uninterrupted reception. Objects such as tall lighthouse, bridges and big ship that block this view will cause a loss of signal. The signal will be quickly restored once the antenna has a clear line of sight again. Heavy rain, cloud, snow or ice may also interfere with the signal reception quality. If the satellite signal is lost due to blockage or severe weather condition, services from the receiver will be lost (picture will freeze frame and may disappear). When the satellite signal strength is again high enough, then the receiver will resume providing desired programming services.

Satellite Frequency Data Changed

If some channels work, while one or more other channels do not, or if the antenna cannot find the selected satellite, the satellite's frequency data might have changed. You can visit any Ocean TV-authorized dealer or Ocean TV distributor for assistance or visit www.oceantv.com.au

Improper Wiring

If the system has been improperly wired, the antenna will not operate correctly. Refer to the User Manual for complete system wiring information.

Loose Cable Connectors

We recommend periodically checking the antenna unit's cable connections. A loose cable connector can reduce signal quality or prevent automatic satellite switching using the receiver's remote control. Fasten the cable connector.

Appendix A

How to Set up the Skew Angle

Signals transmitted in vertical and horizontal wave offset exactly 90° from each other. Since linear satellite signals are oriented in a precise cross pattern, the O45M antenna's receiving element, called an LNB (low-noise block) must be oriented in the same way to optimize reception. This orientation adjustment is referred to as the LNB's "skew angle." The correct skew setting varies depending on your geographic location, since the orientation of your antenna to the satellite changes as you move. This appendix provides how to set up the skew angle.

Australian and New Zealand Versions of the O45M have Auto Skew. No adjustments are necessary.

Adjustments are only necessary to the O37M.

Ocean Series O37M in Australia are preset for Optus C1/D3 for use on Australian East Coast. Special Order O37M are available for Western Australia for use in Perth (No Extra Charge)

Ocean Series O37M in New Zealand are preset for Optus D1.

Setting the Skew Angle

If you have determine the correct skew angle, follow the steps below to adjust the antenna's LNB skew angle.



Caution – To avoid bodily injury, be sure to turn off the antenna and disconnect power to all working components.

SKEW ANGLE

East Coast Australia

OPTUS C1/D3 +30 Degrees
Intelsat 8 +25 Degrees

New Zealand

OPTUS D1 - 60 Degrees

West Coast Australia

OPTUS C1/D3 0 Degrees

All O37M in Australia are set for Optus C1/D3 and in New Zealand Optus D1. O45M have Autoskew, no adjusts are required.

1. Turn off the antenna and disconnect power to all wired components.
2. Using the screwdriver, remove the screws securing the radome. Then remove and set it aside in a safe place.
3. Locate the LNB assembly on the back of the antenna reflector.

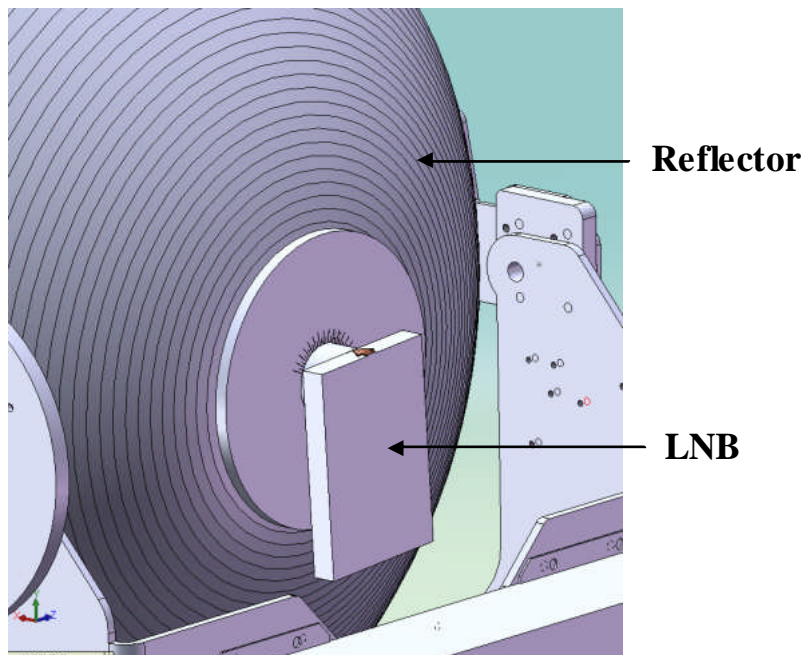

Figure A-2 The Back of the Reflector

4. Loosen the four screws fastening the LNB.
5. Adjust the LNB clockwise or counter-clockwise, until the skew arrow on the LNB points to the skew angle that you determined earlier.

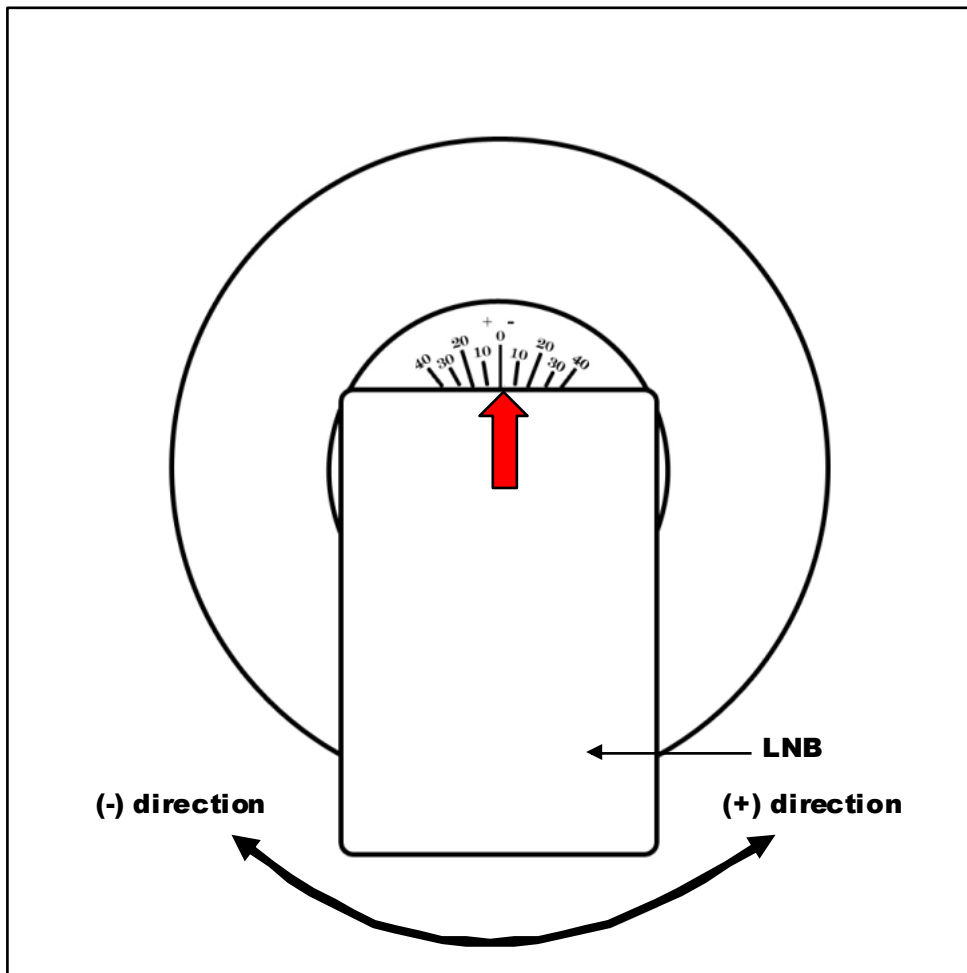

Figure A-3 LNB Skew Angle Adjustment



Caution – Be sure to keep the LNB fully inserted into the hall to ensure the optimum performance.

6. Tighten the four screws.
7. Reinstall the radome.

Appendix B

Satellite Coverage Map

Television satellites are located in fixed positions above the Earth's equator and beam TV signals down to certain regions of the planet (not worldwide). To receive TV signals from a satellite, you must be located within that satellite's unique coverage area.

Satellite Coverage Map

Satellite TV broadcast spot beams are aimed at land masses where the bulk of subscribers can be found. Thus, the signal strength decreases as you travel away from the land masses. The further you travel offshore you will require a larger size antenna. Although this information is believed to be correct, Ocean TV has no control over the variations on the actual satellite footprint coverage. Signal strength and reception can be affected by the weather conditions.

Figure B-1 OPTUS C1/ D3 Coverage Map

NOTE: All of New Zealand - North and South Islands have complete Satellite Coverage

Appendix C

Firmware Upgrade

If satellite beam is changed or eliminated, you have to upgrade firmware of IDU. Ocean TV distributor provides the firmware.

Firmware Upgrade

If antenna cannot search the selected satellite or move incorrectly, you need to change the firmware of IDU. To upgrade the firmware, follow the steps below.

1. Prepare the SD memory card.



Figure C-1 SD memory card

2. Before you use the SD memory card, you should format it to “FAT16(Default)”

Please Note:

Ocean TV is continually improving the Firmware installed on the IDU. If you wish to upgrade the firmware, please contact Ocean TV Australia.

A small charge will be made for the supply of a compatible SD Memory Card. Only approved compatible memory cards are to be used, the use of a non approved memory card may result in the antenna not working correctly.

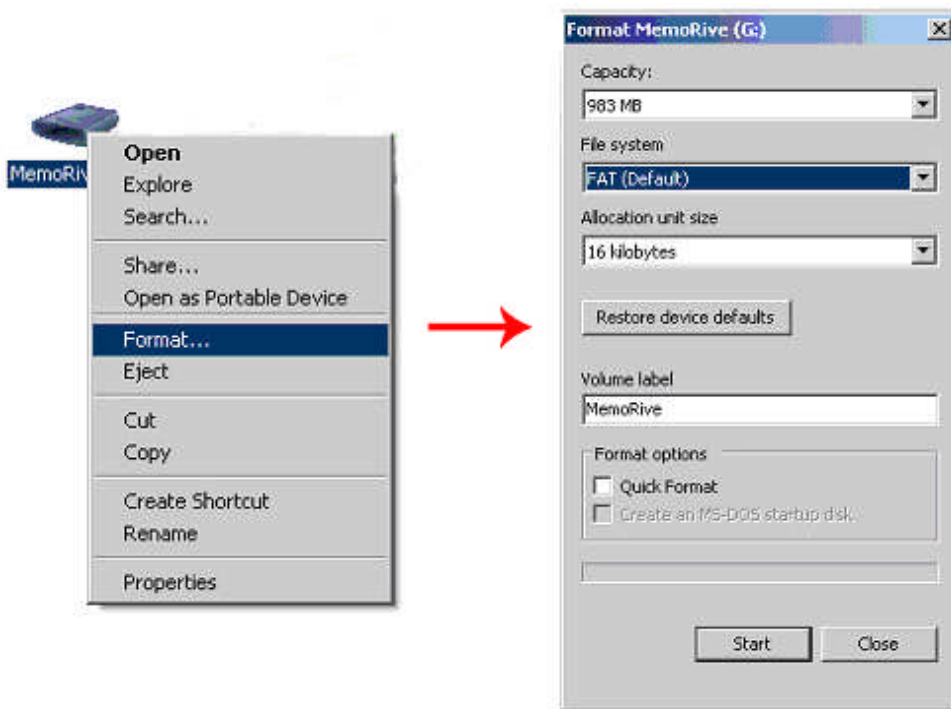

Figure C-2 Formatting SD memory card

3. After formatting your SD card, copy the new software file from Ocean TV distributor.
4. Turn off the IDU.
5. Put your SD memory card into the SD slot of back side of the IDU.

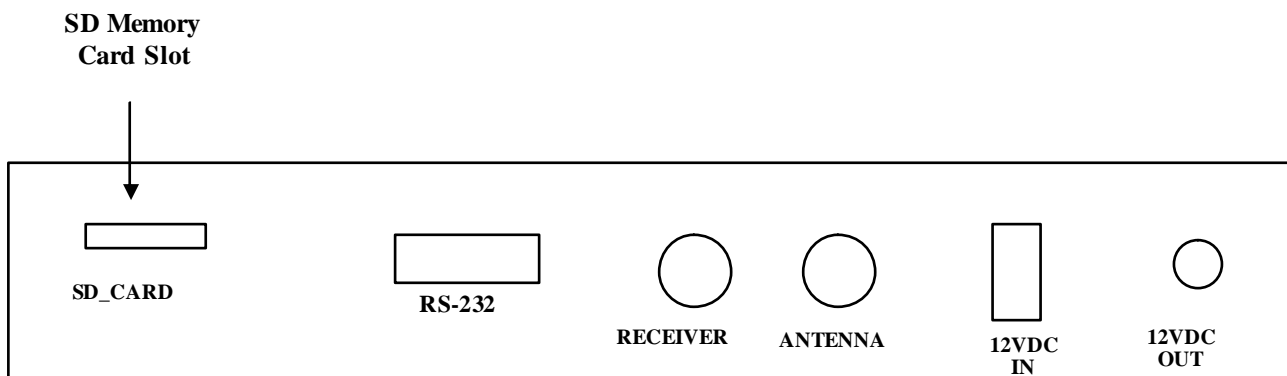

Figure C-3 The back of the IDU

6. Turn on the IDU. You can see the message “WRITING SOFTWARE” in LCD Display.

**WRITING
SOFTWARE**

Figure C-4 Writing software

7. If you see the message “FINISH TO WRITE”, IDU is finishing the software upgrade. You have to wait until the IDU is restarted.

**FINISH TO
WRITE**

Figure C-5 Finishing to write

8. Turn off the IDU. Take your SD memory card away from the IDU.
9. Turn on the IDU.



Appendix D

Antenna Drawing

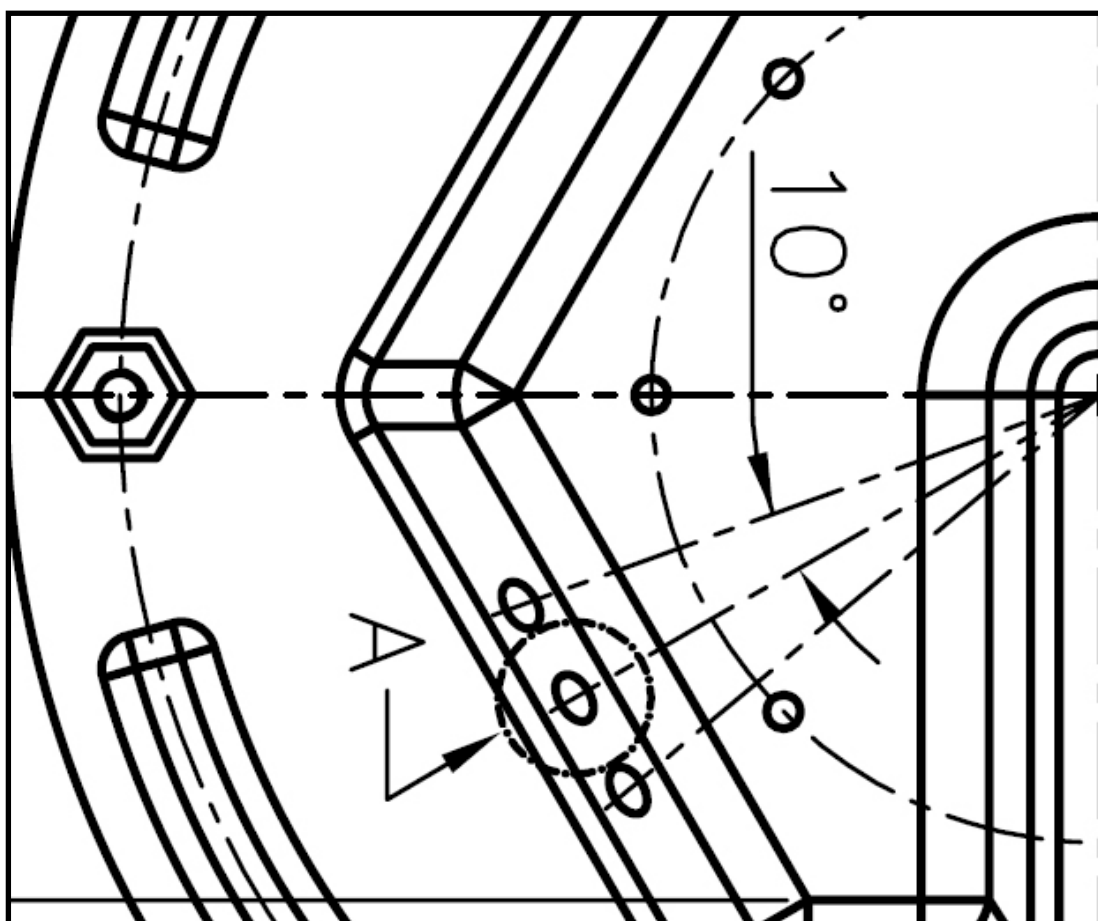

Antenna Drawing O37M

Antenna Drawing

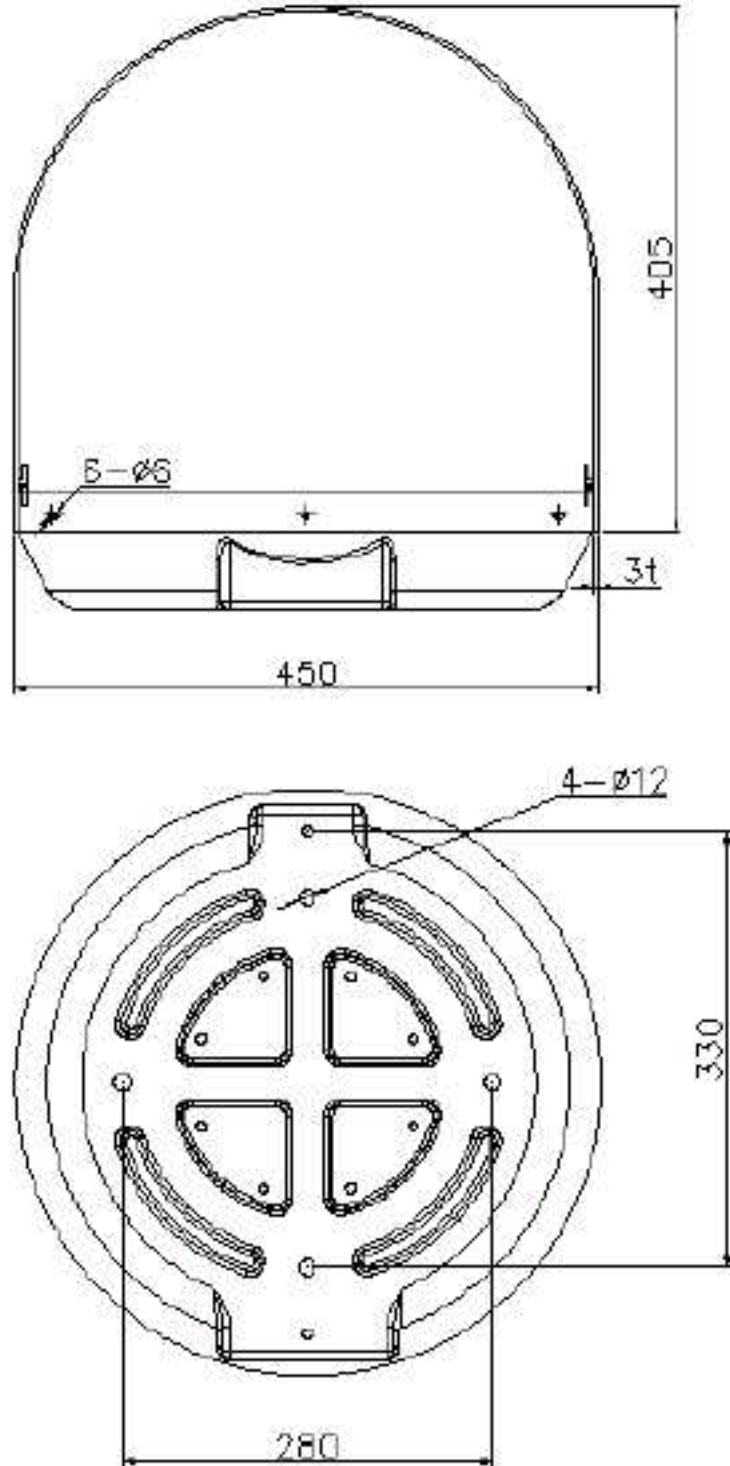

Figure 1-1 O37 Drawing

Antenna Drawing O45M

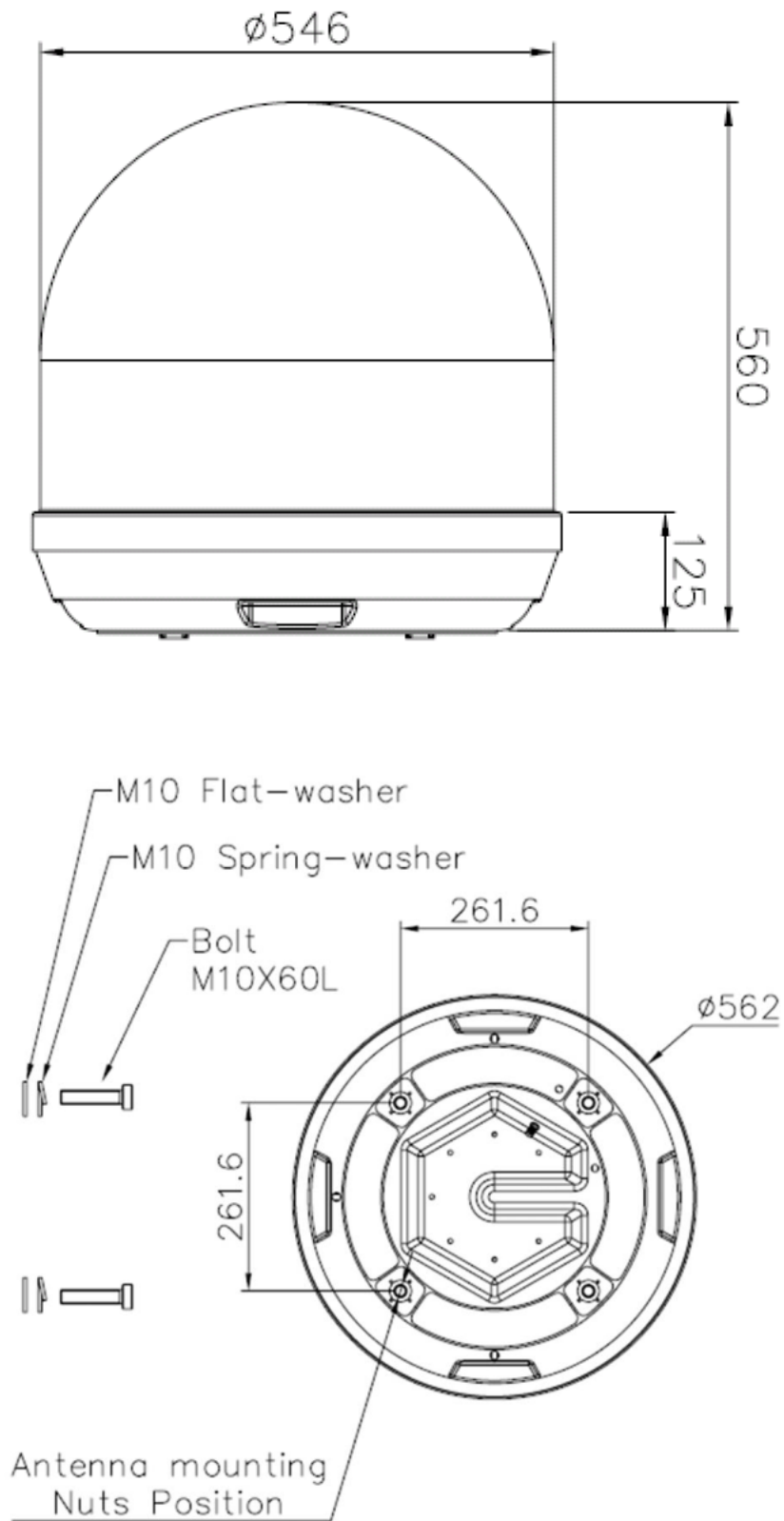

Figure 1-1 O45M Drawing

Appendix E

System Installation Diagrams



Ocean TV Installation Diagram

Setup 1

1 Television with SD Satellite Receiver

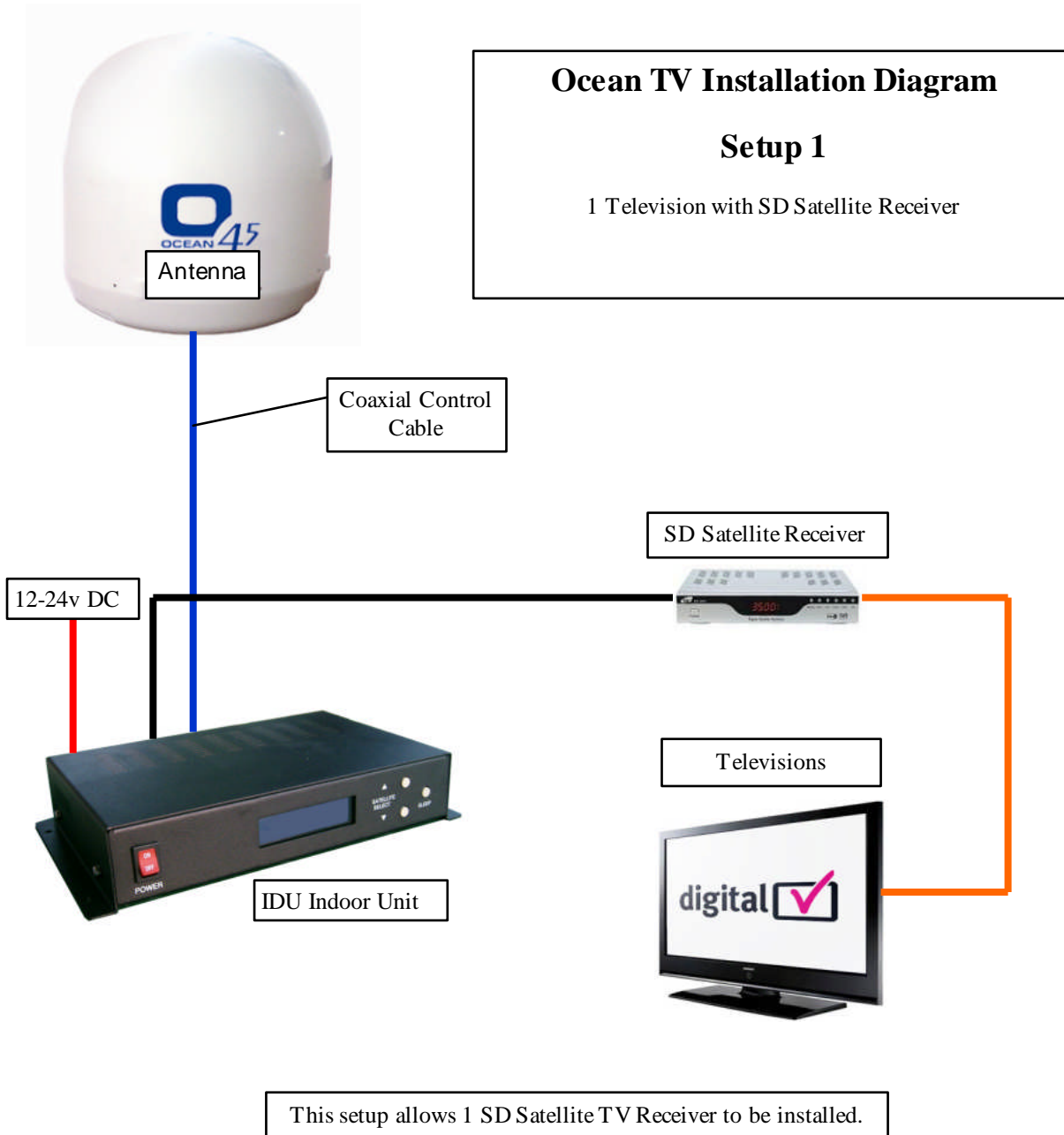

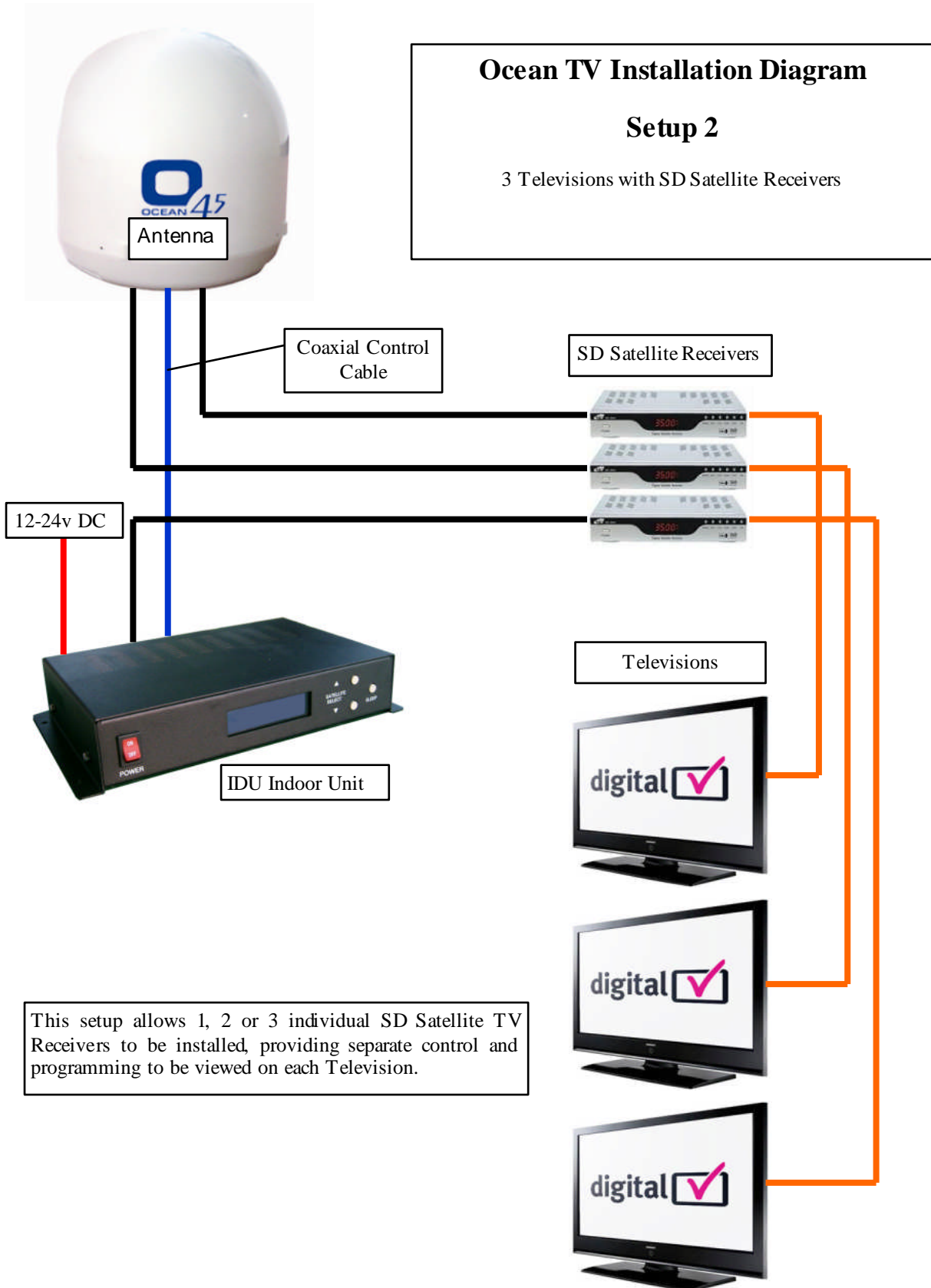

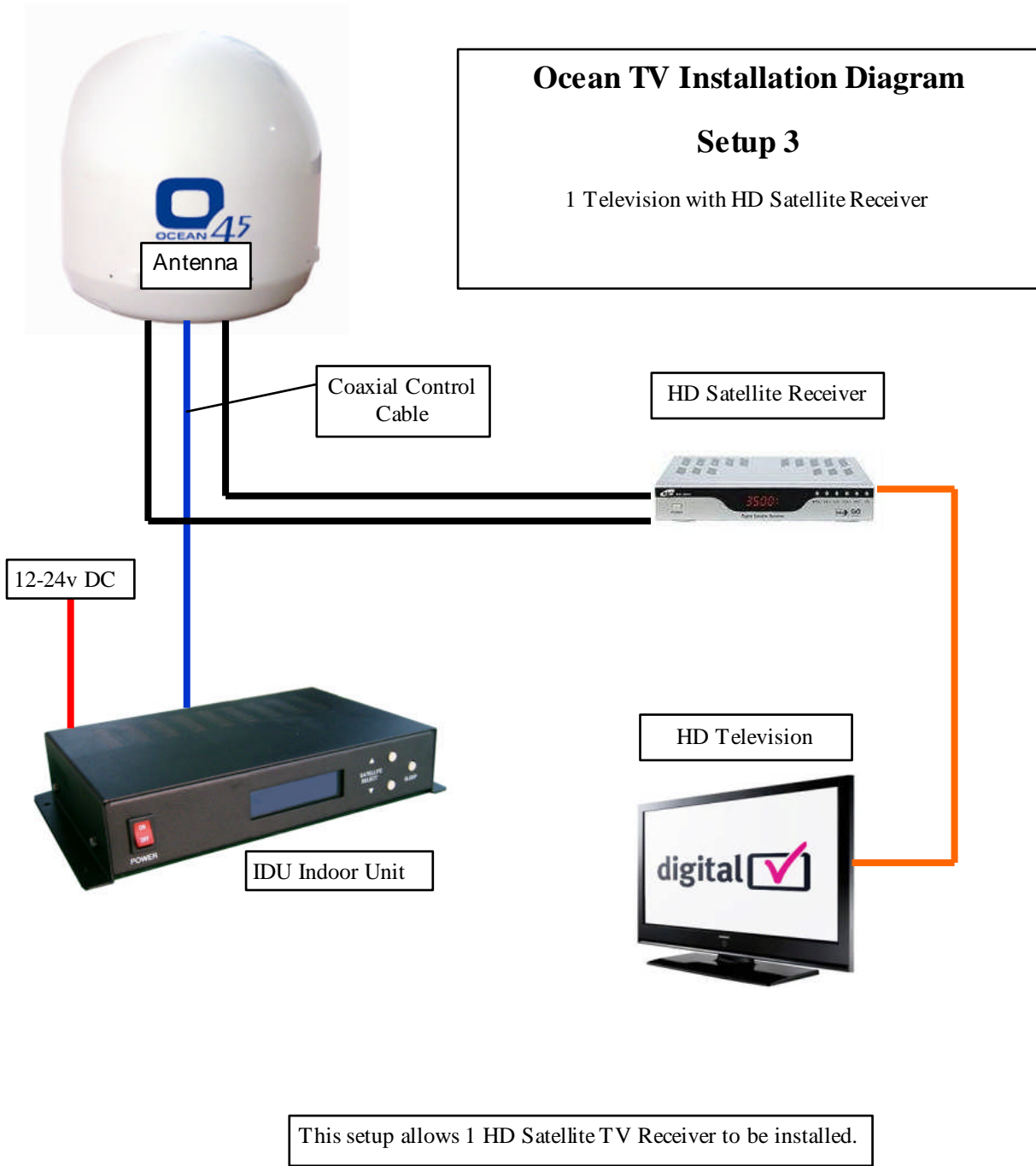

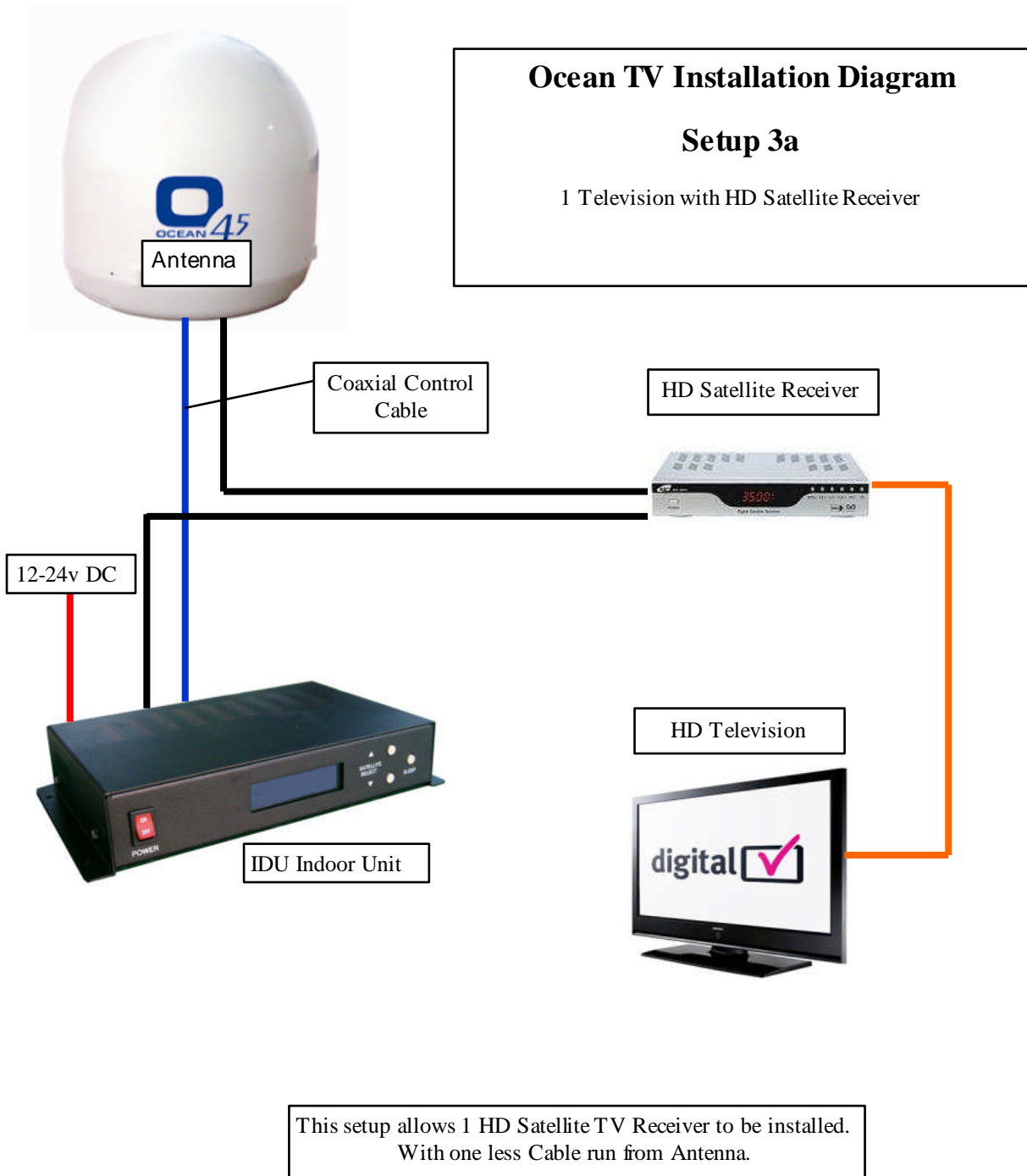

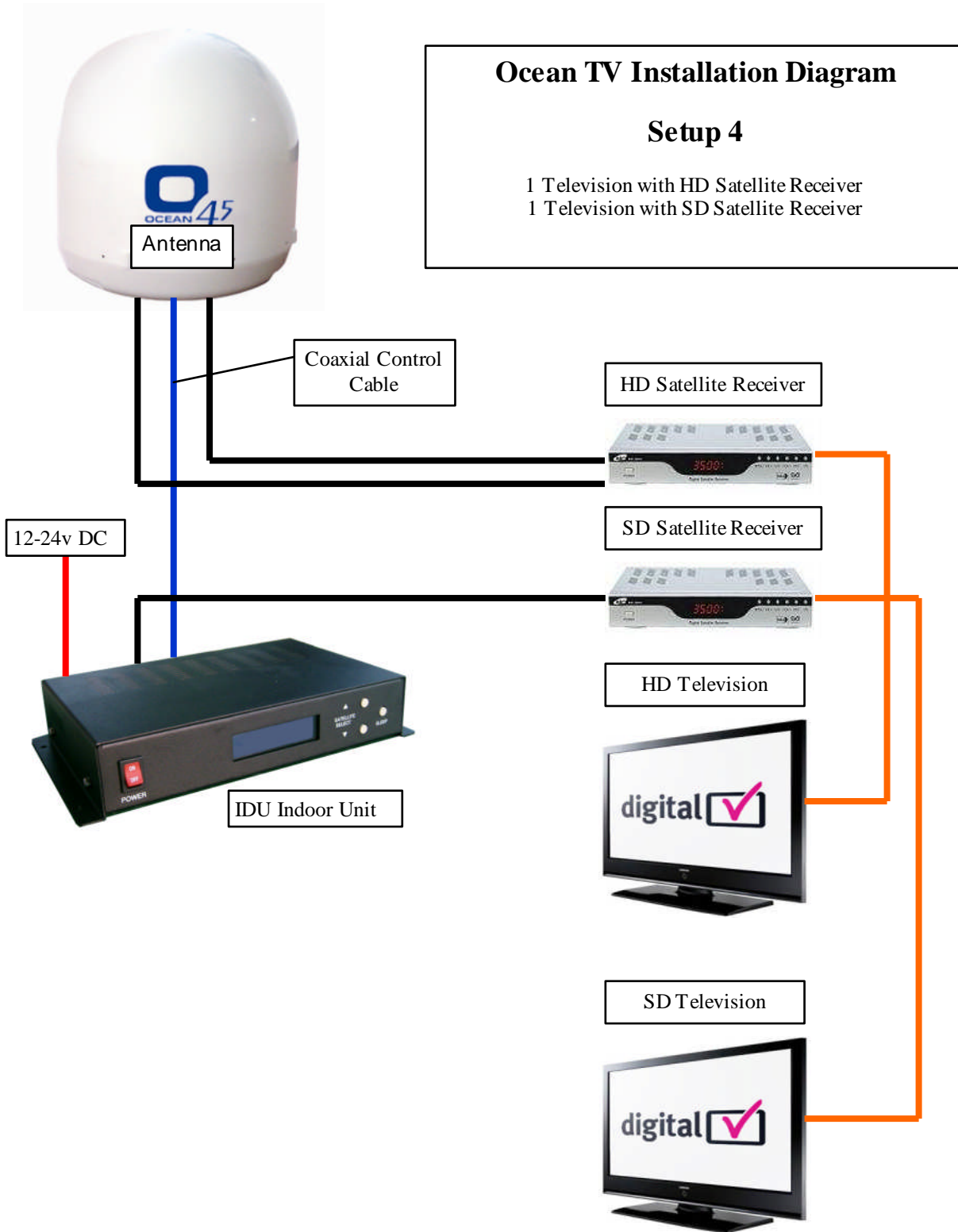

This setup allows 1 HD Satellite TV Receiver and 1 SD Satellite Receiver to be installed, providing separate control and programming on 1 HD Television and 1 SD Television.

Ocean TV Installation Diagram
Setup 5
 Multiple Televisions with HD Satellite Receivers

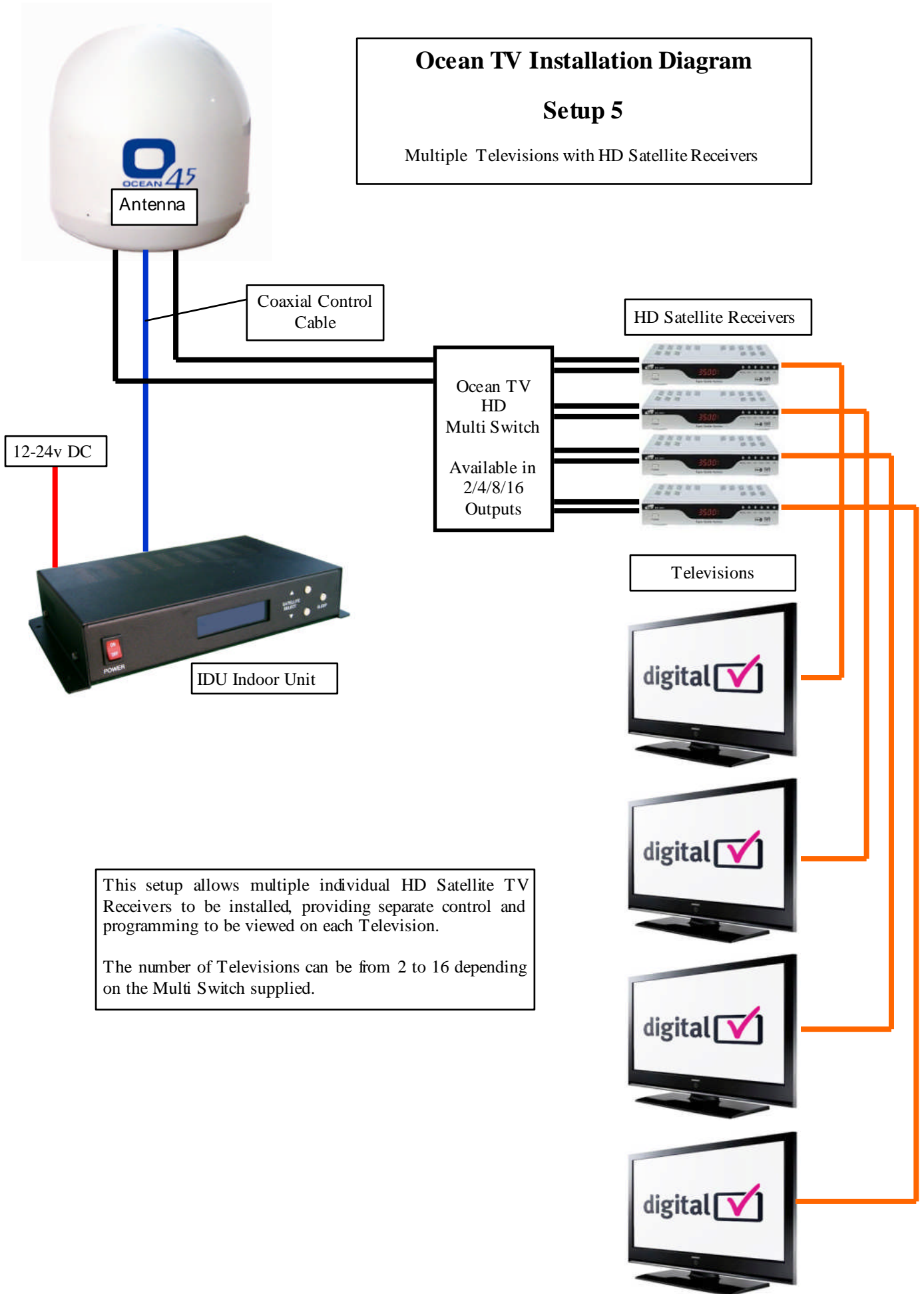

This setup allows multiple individual HD Satellite TV Receivers to be installed, providing separate control and programming to be viewed on each Television.

The number of Televisions can be from 2 to 16 depending on the Multi Switch supplied.

Appendix F

Satellite Coverage Maps

Satellite Coverage Map

Satellite TV broadcast spot beams are aimed at land masses where the bulk of subscribers can be found. Thus, the signal strength decreases as you travel away from the land masses. The further you travel offshore you will require a larger size antenna. Although this information is believed to be correct, Ocean TV has no control over the variations on the actual satellite footprint coverage. Signal strength and reception can be affected by the weather conditions.

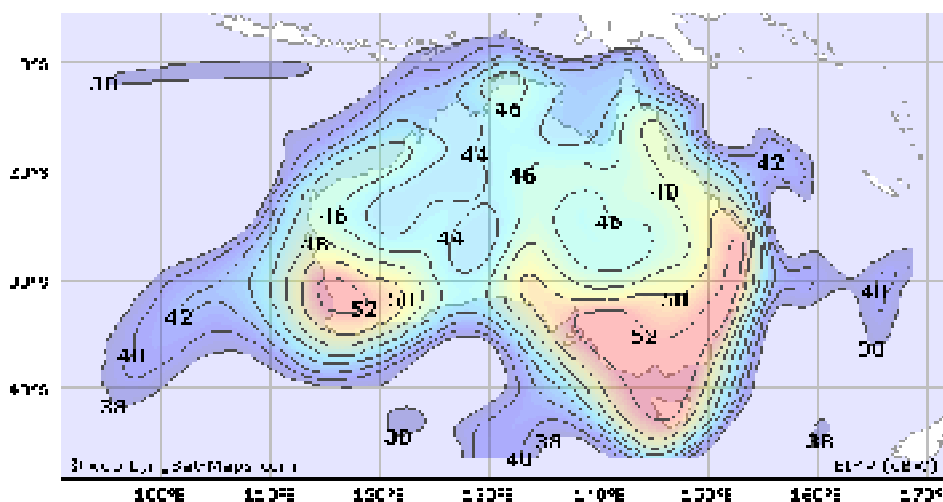

Foxtel - Austar - Aurora
 Optus D3 Satellite Coverage Area
 O37M Requires 50dBW
 O45M Requires 48-49dBW

Foxtel - Austar - Aurora - VAST
 Optus C1 Satellite Coverage Area
 O37M Requires 50dBW
 O45M Requires 48-49dBW

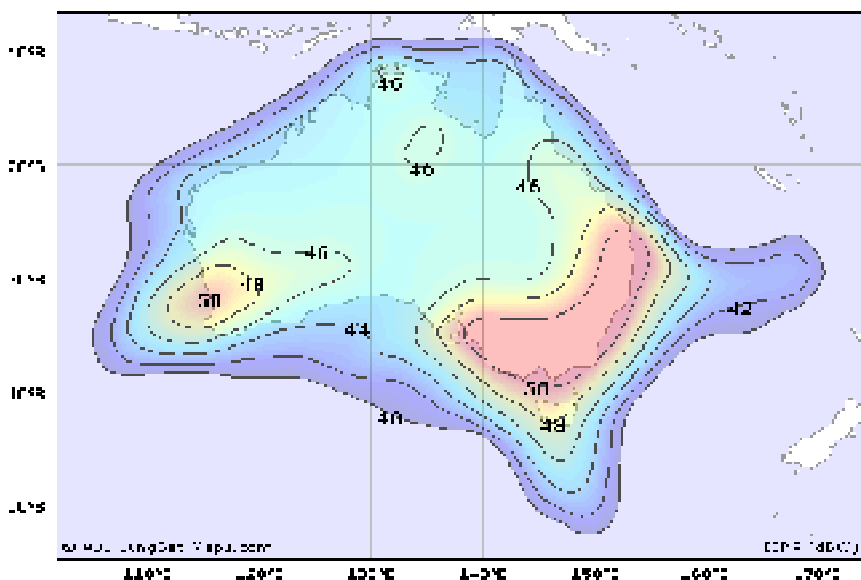

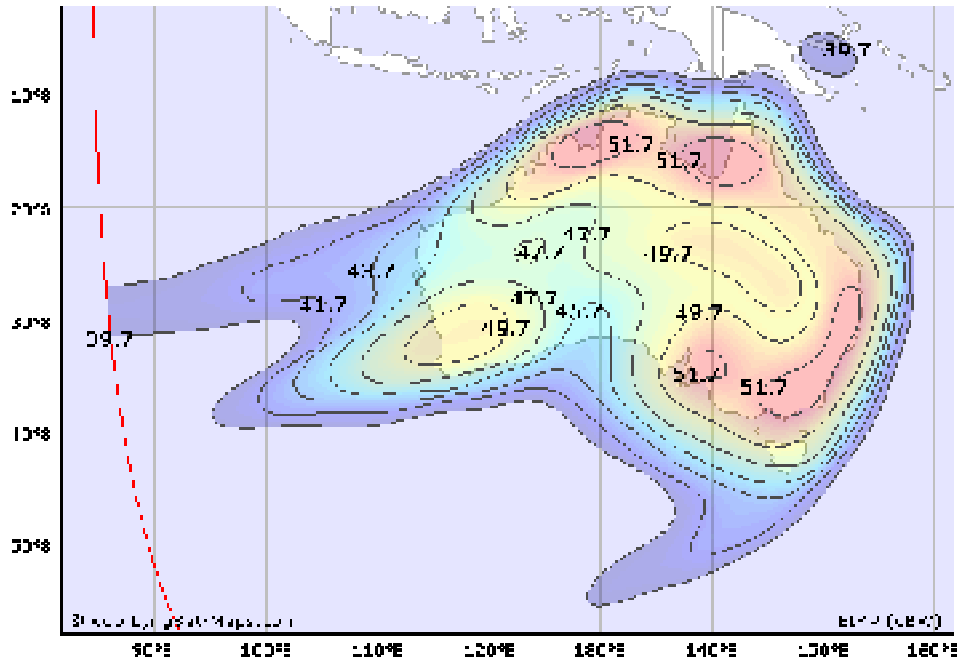

Select TV
Intelsat 8 Satellite Coverage Area

O37M Requires 50dBW
O45M Requires 48-49dBW

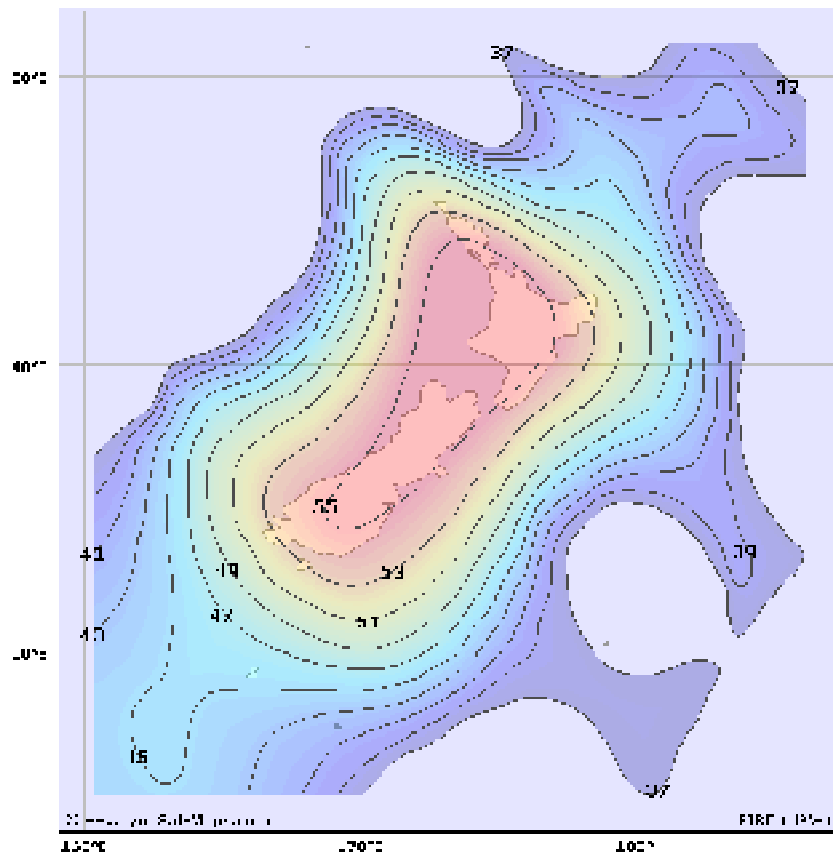

SkyTV - FreeView NZ

Optus D1 Satellite Coverage Area





O37M Requires 50dBW
O45M Requires 48-49dBW

Ocean TV Accessories

Ocean TV has a full range of accessories to make installation even easier. Below are just a few, browse www.oceantv.com.au for the latest accessories.

A range of Ocean TV approved LCD Televisions is also available.. www.oceantv.com.au

	<h3>Compact Multiswitches</h3> <p>Increase the number of HD TV Set top Boxes.</p> <p>OceanTV O37M, O45M, O60M, O600M and O850M Antennas are all HD/IQ Compatible, but when multiple HD/IQ Set Top Boxes are required a Compact Multiswitch can be used. These are available in 2, 4, 6, 8 and 12 users.</p> <p>All are compatible with IQ2 HD Units, and allow full IQ functions.</p> <p>Approvals: Foxtel F10241 Austar A03691</p>
	<h3>Cable Right Angle Adapters</h3> <p>F-59 Plug to F-81 Socket Adaptor Right Angle.</p> <p>Often used when connecting the Coaxial Cable to the outputs of the Antenna. Neat, clean and secure connections, rather than bending the Coaxial Cable.</p>
	<h3>Foxtel Dual Outlet Wall Plate</h3> <p>Outlet Dual Wallplate 2 x F to F Foxtel designed to make your installation professional.</p> <p>Approvals Foxtel F24296</p>
	<h3>Build your Own Wall Plate</h3> <p>Blank Wall Plates with 1, 2, 3, 4 or 6 available inserts. Insert what you need to build a custom wall plate for your entertainment system.</p> <p>Full Range of Inserts available</p>
	<h3>Audio Video Scart Lead</h3> <p>Audio Video Lead Scart Out-3RCA 1.5m Audio Video Lead Scart Out-3RCA 3.0m</p> <p>Approvals Foxtel F10273, F10430</p>

	<p>High Quality RG6 Quad Shield Lead with Crimped Connectors</p> <p>This series is a high quality RG6 Quad shield cable designed specifically for use with the new generation of video signals like Pay TV installations, digital television and traditional analogue video signals.</p> <ul style="list-style-type: none"> * RG6 coax cable with Quad shielding - just like what the pro installers use. * 75Ohm Impedance * Solid copper centre conductor with braid and foil shielding * High quality compression F58 plugs at each end <p>Available in 4 lengths: 1.5M, 3M, 5M and 10M</p>
	<p>HDMI Audio Video Lead</p> <p>Audio Video Lead, HDMI To HDMI, 1.5, 3, 8m</p> <p>Foxtel F30507, F30508, F30533 Austar A091037</p>
	<p>HDMI Lead with Extender - 15m or 20m</p> <p>Extending your high definition AV signals need not be an expensive exercise. Normally HDMI cables should be kept to a maximum of 5 metres to avoid any signal loss or degradation. Longer runs will require the use of external signal amplifiers.</p> <p>These affordable HDMI cables have built-in equaliser boosting the signal strength to enable cable lengths of 15m and 20m without the use of external power supply. Cables are ATC certified and is fully V1.3 compliant and supports 120Hz refresh rate.</p>
	<p>Right Angle HDMI Adaptors</p> <p>Adapts HDMI plug to socket at right angles. Perfect for wall mounted TV applications. Gold plated connections. Two types available :</p> <p>Right Angle Down HDMI Adaptor Right Angle Up HDMI Adaptor</p>
	<p>HDMI Splitter 1 Input to 2 Outputs</p> <p>This tiny switcher routes high definition video (in multiple resolutions up to 1080p) and digital audio from any one of the two sources to display unit. Two inputs accommodate the simultaneous connection of upto two high definition video sources, such as satellite systems and HD DVD players. Switching is done automatically when signal is present on the ports or manually via the push button switch on the unit.</p>

	<p style="text-align: center;">Hard Wired IR Remote Extension Kit</p> <p>Hard Wired Infra-Red repeater kit for use in DIY &/or custom installations, to control an A/V device at a remote location (up to 1.8m). All connections are plug & play, and the kit includes discrete Flat IR target, junction box, double emitter & switch mode power supply. Will work with Foxtel including IQ2</p> <p>STARTER PACK All you need for a simple install a basic in cabinet solution. RPT1041 Connection box with Three IR Transmitter Diodes An Infra-red receiver block and a 240Vac to 12Vdc P-Pack</p> <p>Foxtel IQ compatible</p>
	<p style="text-align: center;">IR TRANSMITTERS</p> <p>IR DIODES Single or paired Mini IR Transmitter diodes for placing near the equipment you wish to control with IR.</p> <p>2 meter flexible black cable 3.5mm plugs to suit RPT1041</p>
	<p style="text-align: center;">IR RECEIVER</p> <p>FLUSH BULLET EYE 45x12mm Mounts flush into a 1/2" hole Connects to the RPT1041 module Three wire cable 3 meters long</p> <p>REPLACEMENT EYE 50x10mm² 2M wire to IR Receiver Black</p>
	<p style="text-align: center;">IR RECEIVER</p> <p>WALL PLATE Optional IR Receiver module Standard wall plate mounting with IR window & reception indicator Three wire screw terminal for Cable run up to 300 meters away Connects to the RPT1041 module White 115x70x15mm</p>
	<p style="text-align: center;">IR RECEIVER + VOLUME</p> <p>WALL PLATE 8W ATTENUATOR 115x70x70mm wall plate mounting with IR window & reception indicator. Requires RPT1041, cable, etc. With 12 position attenuator knob Adjusts Stereo 8W speaker lines Includes impedance matching for running multiple speakers too.</p>

	<p>Pre-programmed Pay TV Set-Top-Box Remote Control</p> <p>Designed specifically to operate your Pay TV Digital Set Top Box and give you direct access to the special features available on the name brand remote. Approx 180mm long.</p> <p>Features:</p> <ul style="list-style-type: none"> Operates the FOXTEL® Digital Set Top Box <p>Stock product may vary from picture</p>
	<p>HDMI Amplifier Splitter 1 Input to 2 Outputs</p> <p>Play your Ocean TV HD Satellite Receiver to more than one HDTV. Use this HDMI amplifier splitter to convert a single HDMI input signal into two identical and simultaneous output signals, all without losing high definition video and audio quality. Single Cable for both HD Video and Audio.</p> <ul style="list-style-type: none"> Supports HDMI 1.3b Up to 2.25Gbps/225MHz
	<p>HDMI 4 x 2 Switch Matrix Splitter</p> <p>Multiple HD Devices switched to Two HD Televisions</p> <p>Share four HDMI sources between two high definition TVs (HDTV). Essentially, you are able to use all of your high definition sources like Satellite Receiver, Blu-ray, PS3, HD set top boxes in your Boats Salon Entertainment centre to another HD display in a separate Cabin or Stateroom. Thus saving you thousands from purchasing HD players all over again! It also reduces cable clutter as well as the hassles of disconnecting and reconnecting sources to a TV with only one or two HDMI inputs. Switch easily between any four HDMI sources with the IR remote included, with up to 16 combinations. Mains plugpack included.</p> <ul style="list-style-type: none"> Supports HDMI 1.3b Supports HDTV 1080p Video amplifier bandwidth 2.25Gbps/225MHz
	<p>180 Watt 12VDC to 230VAC Pure Sine Wave Inverter</p> <p>Having a pure sine wave output makes this inverter ideal for running sensitive items like AC powered Pay Satellite TV Receivers, Notebook Computers and motor-powered devices like fans. The unit continually monitors operational parameters and will alert you to high or low battery voltage, output overload and over-temperature. A USB socket is also fitted and supplies 5VDC for charging USB devices like MP3 players or digital cameras.</p>

Ocean TV

Satellite Television Antennas



© Ocean TV 2010

Australia & New Zealand

Dunham House, 2 Massey Street, Gladesville, 2111, Sydney, Australia.

Phone: Sydney 0428 250 520 Auckland: 09 889 0882

www.oceantv.com.au mark@oceantv.com.au

Examples of Installation

Please send photos of your installation to mark@oceantv.com.au

