



ST4D / ST4E
User Manual

TABLE OF CONTENTS

INTRODUCTION	1
IMPORTANT PRECAUTIONS	2
ELECTROMAGNETIC INTERFERENCE AND WARNINGS	3
IDENTIFICATION OF PARTS	5
CHARGING THE BATTERIES	9
DISASSEMBLING YOUR SCOOTER	10
ASSEMBLING YOUR SCOOTER	11
CARE AND MAINTENANCE	12
OPERATING YOUR SCOOTER	14
TROUBLESHOOTING	16
TECHNICAL SPECIFICATIONS	18
INSPECTION CHECKS	19

INTRODUCTION

Thank you and congratulation on purchasing your new Drive Medical Ltd. Mobility Scooter. It is designed to provide you with transportation ability indoors and outdoors.

We pride ourselves on providing safe and comfortable products. Our goal is to ensure your complete satisfaction. We sincerely hope you enjoy your new Mobility Scooter.

Important symbols in this manual & Product Markings



General risks

This symbol warns you of general hazards!

- Always follow the instructions to avoid injury to the user or damage to the product.



READ WELL BEFORE OPERATION!

This symbol advises you to read information carefully.



This symbol identifies general information which is intended to simplify working with your product and which refers to special functions.



Please read and observe all warning and instruction provided in owner's manual before you operate with various convenient function of this scooter. Also, please retain this booklet for future reference.



The vehicle has been successfully safety-tested to German and international standards. It was also successfully tested to EN60529 IPX4 for splash water insensitivity, and is therefore ideally suitable for typical central European weather conditions.



If you are visually impaired, this document can be viewed in PDF format at www.drivemedical.co.uk or alternatively is available on request in large text.



Life expectancy

We estimate a life expectancy of five years for this product, provided it is used in strict accordance with the intended use as set out in this document and all maintenance and service requirements are met. The estimated life expectancy can be exceeded if the product is carefully used and properly maintained, and provided technical and scientific advances do not result in technical limitations. The life expectancy can also be considerably reduced by extreme or incorrect usage.

The fact that we estimate a life expectancy for this product does not constitute an additional warranty.

If you have any question, you can contact :

or your local dealer:

Information of European Representative :

EMERGO EUROPE

Molenstraat 15

2513 BH, The Hague

The Netherlands

IMPORTANT PRECAUTIONS

- This scooter is designed for single person use only at any one time.
- Maximum load is 136 kgs.
- Turn key off before getting on or off.
- Always drive carefully and be aware of others using the same area.
- Always use pedestrian crossings wherever possible. Take extreme care when crossing roads.
- Do not drive on slope exceeding 10 degree, and take extreme care when turning on slope.
- Do not use full power when turning to sharp corner.
- Take great care and drive in low speed when backing up, riding downhill or on uneven surface, and climbing curb.
- Please use the lowest speed when driving through the descending road or uneven terrain. If speed is too fast, leave your hand off the handle bar, let the scooter stop. Make sure safety and start again.
- The weight capacity limit at different ramp degree (please refer to following picture).

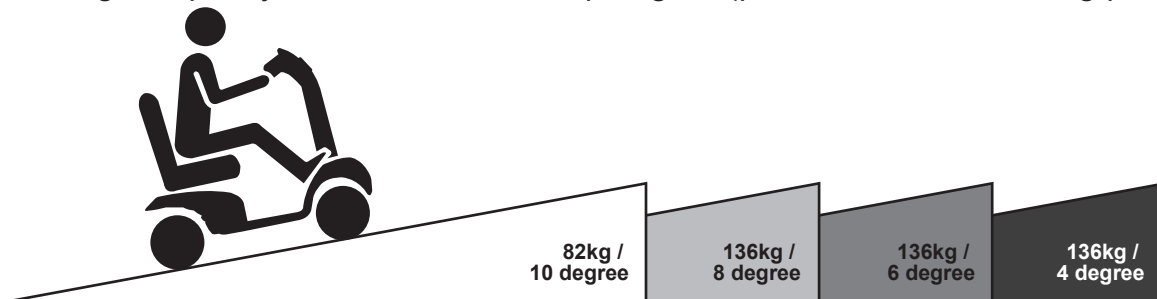

- The grade climbing degree will be affected by weight capacity, driving speed, and ramp degree, and scooter parameter.
- To prevent any danger from motor defected; please avoid to drive on long ramp or any uneven terrain.

- A slow speed must always be used when ascending, descending or traversing aslope or incline and also on uneven terrain, ramps and soft or loose surfaces, such as gravel or grass.
- To prevent any danger, do not turn around at high speed on ascending, descending ramp.
- Scooter may not operate well in high humidity.
- Do not leave the powered scooter in a rain storm of any kind.
- Do not use the powered scooter in a shower.
- Direct exposure to rain or dampness will cause the scooter to malfunction electrically and mechanically; may cause the powered scooter to prematurely rust.
- Never put scooter in neutral when staying on slopes.
- Follow traffic laws when riding outside.
- When scooter on moving transport vehicles, do not sit or stay on scooter.

Risk of injury from hot surfaces!



Do not leave the mobility device in direct sunlight for prolonged periods. Metal parts and surfaces such as the seat and armrests can become very hot.

The scooter ST#4E /4D conforms to the following standards :



- requirements for resistance to ignition in accordance with ISO 7176-16
- seat materials used on this product conform to EN1021 parts 1 and 2.



NOTE:

The control system is programmed with standard values in the works. Your Drive Medical dealer can carry out programming tailored to fit your requirements.

ELECTROMAGNETIC INTERFERENCE AND WARNINGS

CAUTION: It is very important that you read this information regarding the possible effects of Electromagnetic Interference on your motorized scooter.

Powered wheelchairs and motorized scooters may be susceptible to electromagnetic interference (EMI), which is interfering electromagnetic energy (EM) emitted from sources such as radio stations, TV stations, amateur radio (HAM) transmitters, two-way radios, and cellular phones. The interference (from radio wave sources) can cause the motorized scooter to release its brakes, move by itself, or move in unintended directions. It can also permanently damage the motorized scooter control system. The intensity of the interfering EM energy can be measured in volts per meter (V/m). Each motorized scooter can resist EMI up to a certain intensity. This is called its "immunity level." The higher the immunity level, the greater the protection. At this time, current technology is capable of achieving at least a 20 V/m immunity level, which would provide useful protection from the more common sources of radiated EMI. The immunity level of this motorized scooter model is not known.

There are a number of sources of relatively intense electromagnetic fields in the everyday environment. Some of these sources are obvious and easy to avoid. Others are not apparent and exposure is unavoidable. However, we believe that by following the warnings listed below, your risk to EMI will be minimized.

The sources of radiated EMI can be broadly classified into three types :

1. Hand-held portable transceivers (transmitters-receivers) with the antenna mounted directly on the transmitting unit. Examples include: citizens band (CB) radios, "walkie talkie," security, fire, and police transceivers, cellular telephones, and other personal communication devices



Some cellular telephones and similar devices transmit signals while they are ON, even when not being used

2. Medium-range mobile transceivers, such as those used in police cars, fire trucks, ambulances, and taxis. These usually have the antenna mounted on the outside of the vehicle; and

3. Long-range transmitters and transceivers such as commercial broadcast transmitters (radio and TV broadcast antenna towers) and amateur (HAM) radios



Other types of hand-held devices, such as cordless phones, laptop computers, AM/FM radios, TV sets, CD players, and cassette players, and small appliances, such as electric shavers and hair dryers, so far as we know, are not likely to cause EMI problems to your motorized scooter.

Motorized Scooter Electromagnetic Interference :

Because EM energy rapidly becomes more intense as one moves closer to the transmitting antenna (source), the EM fields from hand-held radio wave sources (transceivers) are of special concern. It is possible to unintentionally bring high levels of EM energy very close to the motorized scooter control system while using these devices. This can affect motorized scooter movement and braking. Therefore, the warnings listed below are recommended to prevent possible interference with the control system of the motorized scooter.

Safety information on electromagnetic interference

This electric vehicle was successfully tested in accordance with International standards as to its compliance with Electromagnetic Interference (EMI) regulations. However, electromagnetic fields, such as those generated by radio and television transmitters, and cellular phones can influence the functions of electric vehicles. Also, the electronics used in our vehicles can generate a low level of electromagnetic interference, which however will remain within the tolerance permitted by law. For these reasons we ask you to please observe the following precautions:

Warnings :**Danger of malfunction due to electromagnetic interference!**

- Do not switch on or operate portable transceivers or communication devices (such as radio transceivers or cellular phones) when the vehicle is switched on.
- Avoid getting near strong radio and television transmitters.
- In case the vehicle should be set in motion unintentionally or the brakes are released, switch it off immediately.
- Adding electrical accessories and other components or modifying the vehicle in any way can make it susceptible to electromagnetic interference. Keep in mind that there is no sure way to determine the effect such modifications will have on the overall immunity of the electronic system.
- Report all occurrences of unintentional movement of the vehicle, or release of the electric brakes to the manufacturer.

Important Information :

1.20 volts per meter (V/m) is a generally achievable and useful immunity level against EMI (as of May 1994). The higher the level, the greater the protection.

2.The immunity level of this product is at least 20V/m.

IDENTIFICATION OF PARTS

Before attempting to drive this scooter on your own, it is important that you familiarize yourself with the controls, and how to operate.

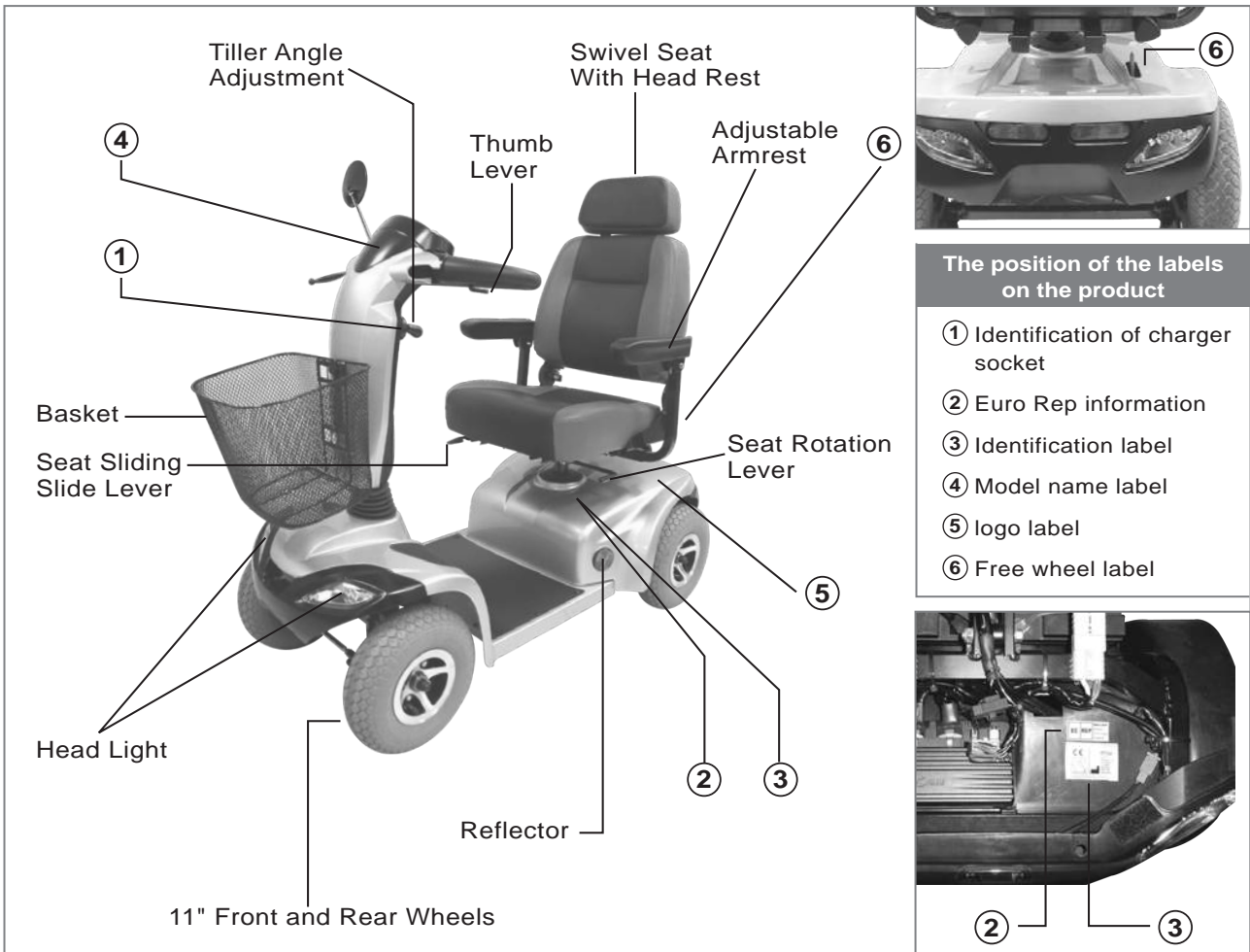

- The position of the labels on the product
- ① Identification of charger socket
 - ② Euro Rep information
 - ③ Identification label
 - ④ Model name label
 - ⑤ logo label
 - ⑥ Free wheel label

Figure 1 - ST-4E / ST-4D Front View

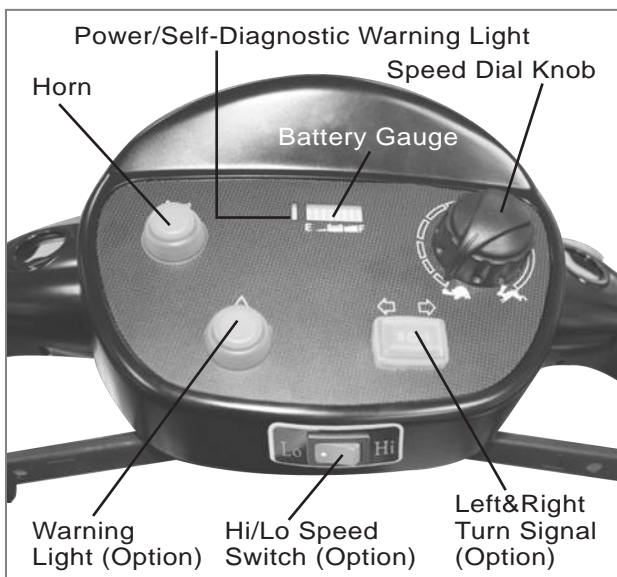

Figure 2 - ST-4E / ST-4D Control Panel

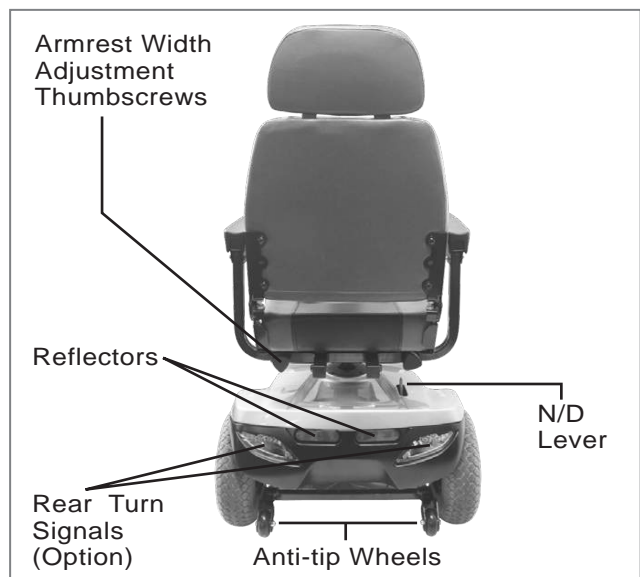



Figure 3 - ST-4E / ST-4D Rear View

FUNCTION OF PARTS :**MAIN SWITCH (A)**

1. By turning the key clockwise to ON to turn on the power
2. By turning the key anticlockwise to OFF to turn off the power.
3. By turning the key to  to turn on the head light.

Speed Dial Knob (B)

The Rabbit means fast and Turtle is slow.

By turning this you control total speed transferred to thumb controls.



Do not set the speed at maximum when operating the scooter. Adjust the speed at maximum when inclining a slope, and adjust to minimum speed when declining a slope.

Horn Button (C)

Pressing down the button to sound buzzer.

Battery Gauge (D)

There is a meter shows batteries capacity status.

When battery gauge's light trends to **F**, it indicates sufficient power capacity.

When battery gauge's light trends to **E**, it indicates insufficient power capacity.



Check battery's capacity before driving, and charging batteries when at low power.

TOP CONTROL PANEL (Hi/Lo)

High & Low Speed Switch allows speed to be changed from the normal maximum 12.8 kmph to half for pavement use.

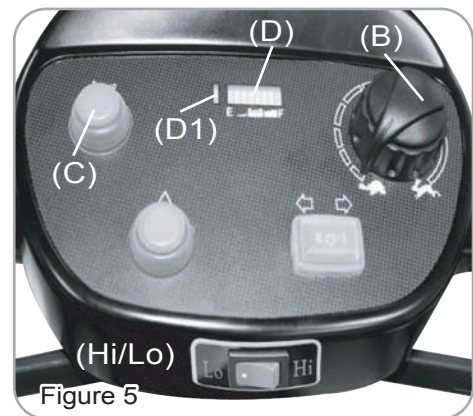
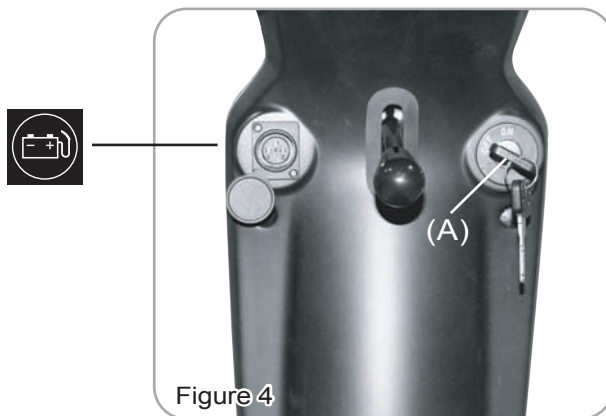
**Panel Control**

Pressing down  at left side as left turn signal.

Pressing down  at right side as right turn signal.

Pressing down  as warning light.



Thumb Lever

Pulling right thumb lever (E) moves scooter forward. Pulling left thumb lever (F) moves the scooter backward. (This can be reversed if required by local dealer.) Releasing both, engages automatic brake. These are also your accelerator. The further you depress them, the faster you go. (Subject to the position of the Rabbit/Turtle control).

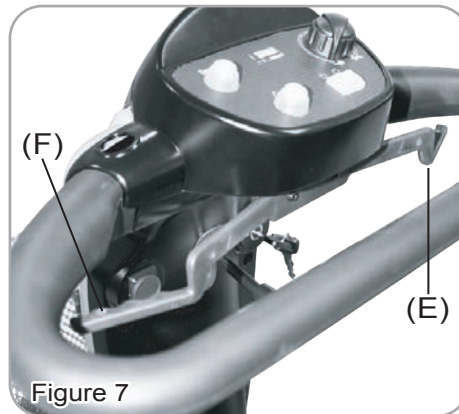

Tiller Angle Adjustment

Pulling the tiller adjustment (G) downwards to adjust tiller's angle and release to lock at a desired comfortable position.

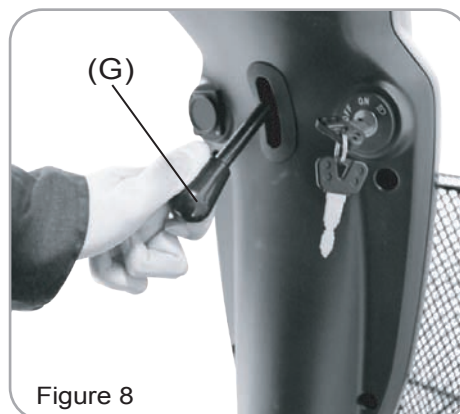

Seat Swivel Adjustment

Setting at a comfortable angle by pulling lever (H) upwards to rotate seat (a) left and right..

Seat fore-aft Adjustment

Setting at a comfortable position by lifting lever (I) upwards to adjust the seat (a).

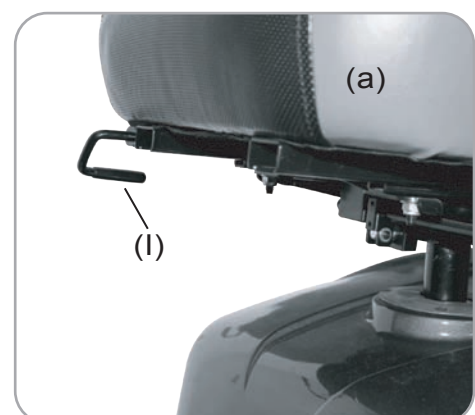
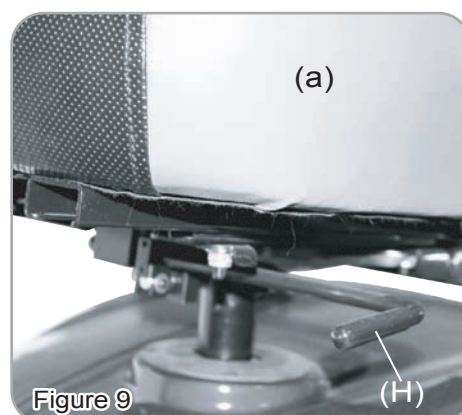

Armrest width Adjustment Thumbscrews

1. Loosen the two thumbscrews (K) to adjust arm width tighten again to lock in at desired position.
2. Adjust the attached screw (J)'s height, to control armrest's angle.

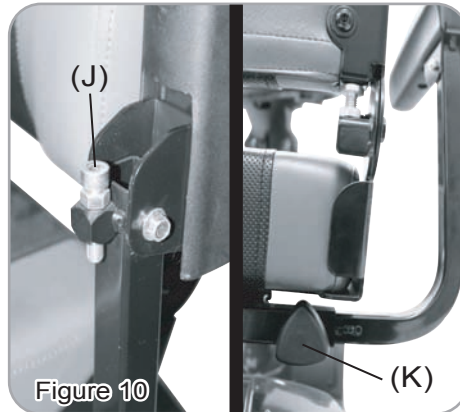
**Anti-tip wheels**

Helps keep scooter from tipping over.

Free-Wheeling Lever (L)

When lever is in N (Neutral) position, scooter can be moved manually without power. When lever is in D (Drive) position, scooter can be driven. Normal position is D.

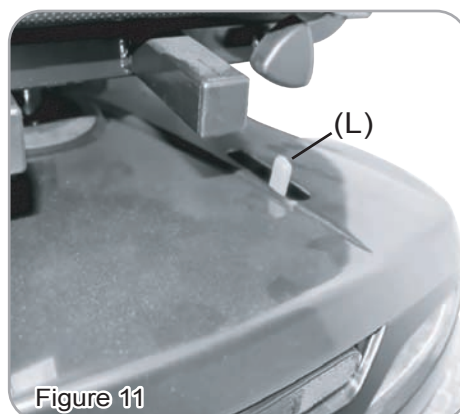
**Your scooter should be delivered fully configured for your use;**

There are a range of components and adjustments available on the ST#4E /4D. For further information about these you should contact your Drive Medical authorised dealer.

CHARGING THE BATTERIES

Batteries must be charged before using the scooter for the first time and should be recharged after each day use. You will need the scooter and the battery charger.



Each country may supply different charger. The charging procedure may be different from below.

If you require more details, please contact your authorized dealer.



Be sure the scooter key is in the OFF position

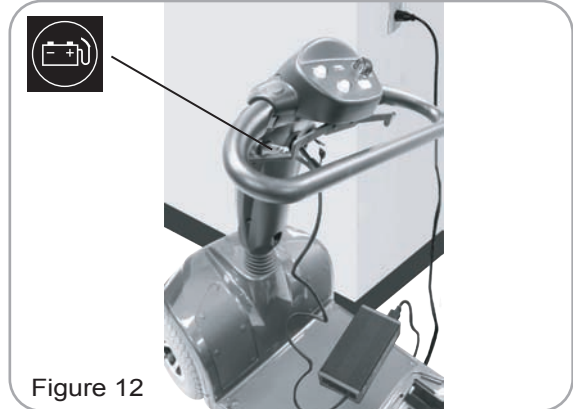

Figure 12

1. Insert battery charger cord into the charger connector on the charger output. Refer to above figure for correct position
2. Plug the other end of the battery charger cable into a standard electrical outlet.
3. Turn the power on. Normally, The LED (Power) Light will turn on when electric current passes.
4. Charging starts. During charging, LED (Charge) will indicate orange light, when it turns to green light, that means well-charged.
5. LED indication
 - LED(POWER) - GREEN LIGHT ON : Power On.
 - LED(CHARGE) - ORANGE LIGHT ON : Charging / GREEN LIGHT ON : Fully Charged
6. Charger Trouble Shooting
 - (A) If LED (POWER) light is off
 - Check the input voltage (115V/230V) is the same as you adjust.
 - If light is still off, please check and repair the battery charger.
 - (B) If LED (CHARGE) light is off
 - Check to see clips connection is correct.
 - If the battery is fully charged, the LED (CHARGE) light will be off.
 - If light is still off, the battery may be defective.
 - (C) If ORANGE light can turn to GREEN
 - The battery can not be charged. Please check and recover it.
 - (D) If ORANGE light turns to GREEN immediately
 - Check to see the battery is fully charged, if not, The battery may be defective Check and recover it.



The time needed to recharge will vary depending on the depletion of the batteries. Charging for longer than necessary will not harm the batteries. They can not be overcharged.

Keep in mind these rules :



- Fully charge batteries at least once a month, or more if you use scooter regularly. Charge after each trip exceeding 3 kilometers.
- If storing your scooter for some time (1 month or more), make sure that batteries are fully charged, and on returning, charge them again before using scooter.
- Batteries will only give maximum performance after scooter has been used, and batteries have been recharged up to 10 times. A bit like breaking in a new car.

DISASSEMBLING YOUR SCOOTER

Disassembling Basket

By lifting the basket (O) upwards.

Disassembling Seat

By lifting lever (H) and seat (a) upward.

Rear Compartment Cover

Open the Compartment Cover (P) according to arrow's direction.

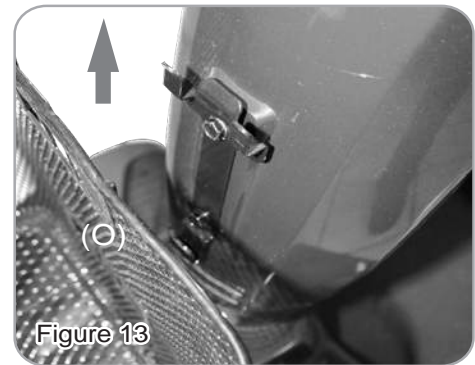

Figure 13

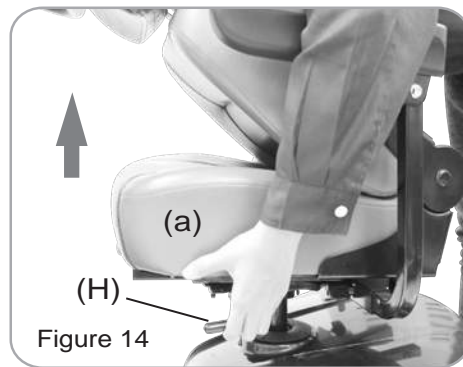

Figure 14



Figure 15

ST4D : Disassembling Batteries

Disconnect front & rear section wire harness (Q), then tear off battery straps (R) and battery terminals (S) to remove the batteries (b). (Figure.16 & 17)



**Be careful when removing batteries, as batteries are heavy.
Do not contact battery terminal \ominus \oplus with any metals to avoid danger.**

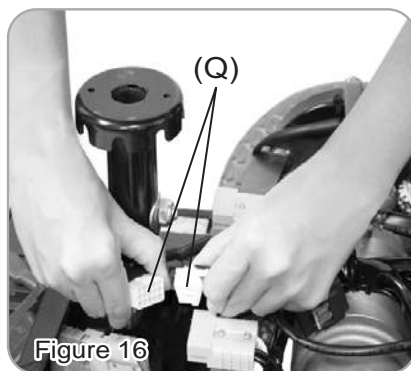

Figure 16

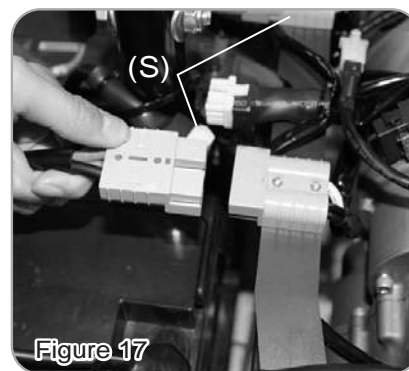
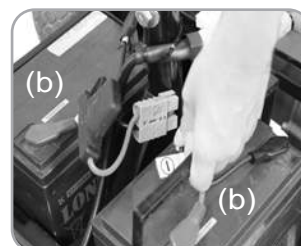

Figure 17



ST4E : Disassembling Batteries

Disconnect front & rear section wire harness (T), then tear off battery straps (U) and battery terminals (V) to remove the batteries (b). (Figure.18 & 19)



**Be careful when removing batteries, as batteries are heavy.
Do not contact battery terminal \ominus \oplus with any metals to avoid danger.**

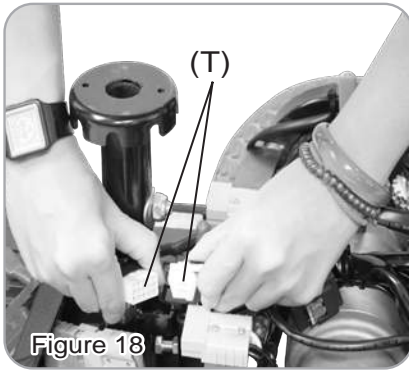

Figure 18

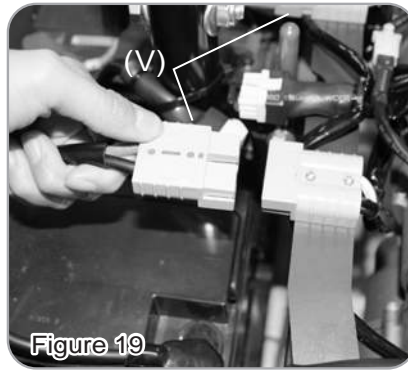

Figure 19

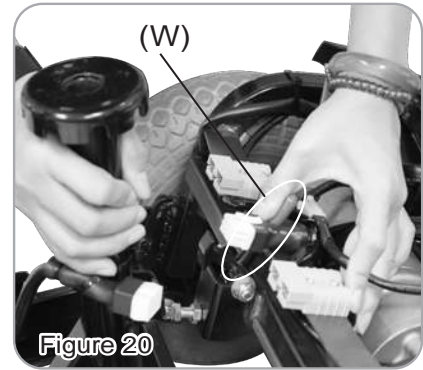
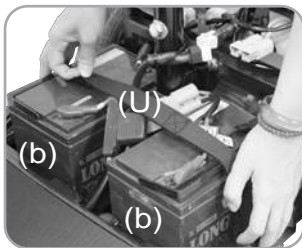

Figure 20



(b)

(U)

(b)

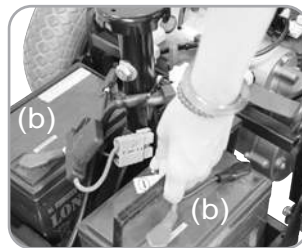

(b)

(b)

**Disassembling Front and Rear Frame**

By pulling the frame hook comp (W) backwards to disconnect front and rear frame. (Figure.20)

ASSEMBLING YOUR SCOOTER

To assemble scooter, you can repeat disassembly directions in reverse. Abbreviated directions are given below. Refer to Figures on pages 10 to locate parts.

1. Use the tiller adjustment to move tiller up and out of the way.
2. Place front basket.
3. Place battery pack in battery compartment.
4. Place seat on seat post and tighten seat locker knob.

CARE AND MAINTENANCE

Cleaning Your Scooter :

- i** If your scooter is dirty, use a damp or lightly soapy cloth to wipe it down. Do not use running water to wash or rinse scooter in order to protect electrical parts. Polish with an automotive liquid polish.

Maintaining Your Scooter :

- i** All maintenance and repair of scooter should be done by an authorized dealer. The following areas required periodic inspection:

- Tyre pressure (Tyre pressure = 2.4 - 2.7 bar.)
- All electrical connections are firmly attached

Storing Your Scooter :

- i** Between uses, your scooter is best stored in a dry location.

Remark :

Obstacle height approx. 5cm (Figure.21)

Feasible groove width approx. 17cm, scooter must go straight line to across the groove. (Figure.22)

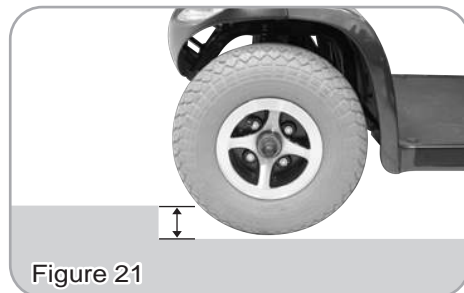

Figure 21



Figure 22

- When driving scooter on ramp, adjust body center of gravity to keep scooter more safety.



General driving posture



On ramp, forward your body will let scooter more safety.

- i** Please Contact your approved drive Medical Dealer for further information regarding Servicing of the scooter, as it is recommended that only authorized drive Medical Dealer carry out this work.

Requirements for end user service tools required

- Open-ended spanner, 12 mm
- Open spanner, 17 mm.
- Rubber hammer

- i** Please contact your drive Medical dealer as it is recommended that only authorized drive dealer carry out any such work.

Safety information with regard to care and maintenance

Danger of accident and loss of guarantee if maintenance is insufficient!

- For reasons of safety and in order to avoid accidents which result from unnoticed wear, it is important that this electric mobility product undergoes an inspection once every year under normal operating conditions (see inspection plan contained in service instructions).
- Under difficult operating conditions such as daily travel on steep slopes, or in the case of use in medical care cases with frequently changing wheelchair users, it would be expedient to carry out intermediate checks on the brakes, accessories and running gear.
- If the mobility product is to be operated on public roads, the vehicle driver is responsible for ensuring that it is in an operationally reliable condition. Inadequate or neglected care and maintenance of the mobility product will result in a limitation of the manufacturer's liability.

OPERATING YOUR SCOOTER

You could make the following adjustments to increase your comfort when driving.

- adjust seat position.
- adjust armrest width to comfortable position.
- adjust tiller's angle.

1. Before operating your scooter, check the following:

- free-wheeling lever in D
- speed dial knob is at turtle picture.

2. Sit on scooter and turn on key, Battery Gauge meter should be indicate at F.
The Self-Diagnostic Warning Light should not be blinking.

3. When your hands rest comfortably on handlebars, the thumb levers should be within easy reach. The right lever moves scooter forward, the left one moves it backward. When you release both levers, scooter will stop.



This scooter has automatic braking system. Release the thumb lever and brake will stop scooter.

4. Steer scooter by turning tiller toward the way you want to go.

5. Practice driving where there are is No obstacle. Start at the slowest speed and drive forward and backward; make some turns. As you get more comfortable, you can increase speed by turning speed dial toward picture of rabbit.

6. If Battery Gauge indicates **E**, you should plan to recharge batteries very soon.

7. When you are finished riding, turn off the key before getting off.

8. If you are finished riding for the day, immediately recharge batteries.

See CHARGING THE BATTERIES, page 9.

Keep in mind these rules :

- Release thumb levers and allow scooter to stop completely before changing from forward to reverse, or reverse to forward.
- When turning to corner, swing front wheels widely, so back wheels will turn more tightly.
- Use scooter only where it is safe for waiting.
- Drive in low speeds when reversing, riding downhill, over ramp or curb, or on uneven surface, downhill, ramps, curbs, or uneven surfaces.

Other Operating Information :

Hill climbing: You may need to use a higher speed. Turn to lower speed before going downhill.



Down slopes: proceed with downward slopes slowly, and set speed control in proximity of turtle. The closer speed control is set toward turtle, the slower scooter travels. However, this scooter will not self accelerate down hills due to the automatic braking, taking effect should you attempt to drive too fast.



Kerb climbing: Approach slowly from right angles to curb. A slight angle is permissible with a 4-wheel scooter. Do not attempt greater than a 5cm curb.

If Self-Diagnostic Warning Light starts to blink, identify problem from chart on page 16 and take action.

If the scooter breaks down and must be moved, get off scooter, engage Free-Wheeling Lever to N, push scooter slowly to a safe location, and push lever back to D.



In unlikely event of a panel display error, you need to re-set the display system by cycling the on/off main switch. The display circuitry is independent of the motor control system. A display console error does not affect scooter speed control.

TROUBLESHOOTING

Here are some suggestions about solving problems you may have with your scooter. There is a Self-Diagnostic Warning Light on the Control Panel. To check the Self-Diagnostic Warning Light, turn on the key and count the number of blinks on the Warning Light.

Flash	Description	Meaning
1	Battery Low	The batteries are running low. • Recharge the batteries.
2	Low Battery Fault	The batteries have run out of charge. • Recharge the batteries. • Check the battery and associated connections and wiring.
<p>The Low Battery Fault Flash code, described above, is a requirement of various safety standards.</p> <p> The scooter will output a visible and audible low battery warning if the battery voltage drops below 90% of its cut-off voltage. The warning will be two short flashes, and will take priority over all other flash codes in the system.</p>		
3	High Battery Fault	Battery voltage is too high. This may occur if overcharged &/or travelling down a long slope. • If travelling down a slope, reduce your speed to minimize the amount of regenerative charging.
4	Current Limit Time-out or Controller too hot	The motor has been exceeding its maximum current rating for too long. • The scooter may have stalled. Turn the controller off, leave for a few minutes and turn back on again. • The motor may be faulty. Check the motor and associated connections and wiring.
5	Park Brake Fault	Either a park brake release switch is active or the park brake is faulty. • Check the park brake and associated connections and wiring. • Ensure any associated switches are in their correct positions.
6	Drive Inhibit	Either a Stop function is active or a Charger Inhibit or OONAPU condition has occurred. • Release the Stop condition (seat raised etc.) • Disconnect the Battery Charger • Ensure the throttle is in neutral when turning the controller on. • The Throttle may require re-calibration.
7	Speed Pot Fault	The throttle, speed limit pot, SRW or their associated wiring may be faulty. • Check the throttle and speed pot and associated connections and wiring.
8	Motor Voltage Fault	The motor or its associated wiring is faulty. • Check the motor and associated connections and wiring.

9	Other error	The controller may have an internal fault. • Check all connections and wiring.
---	-------------	---

Other Problems

Low tire pressure: pump up tires to 2.4 - 2.7 bar.

During charging, light on charger does not change to green: Contact your authorized dealer.

Scooter will not move when key is turned on:

1. Check Power Reserve Indicator on control panel, it should be lighting in green, yellow, and red zones.
2. Check Self-Diagnostic Warning Light, it should be steady. If it is flashing, see chart above for problem identification.
3. Check all electrical connections to be sure they are tight.
4. If none of above correct problem, contact your authorized dealer.

TECHNICAL SPECIFICATIONS

SPECIFICATIONS	ST4E	ST4D
Overall Length	1200 mm / 47.2"	1200 mm / 47.2"
Overall Width	620 mm / 24.4"	628 mm / 24.7"
Overall Height	1190 mm / 47"	1190 mm / 47"
Wheels: Front	290 mm / 11"	290 mm / 11"
Wheels: Rear	290 mm / 11"	290 mm / 11"
Weight w/ Batteries	87 kg / 191 lbs	100.7 kg / 222 lbs
Max. Speed	8 kmph / 5 mph	12 kmph / 7.5 mph
Weight Capacity	136 kg / 300 lbs	136 kg / 300 lbs
Ground Clearance	60 mm / 2.4"	80 mm / 3.1"
Grade Climbable	10 degree	10 degree
Curb Climbing	50 mm / 2"	50 mm / 2"
Turning Radius	1540 mm / 60.6"	1540 mm / 60.6"
Suspension	N/A	Front & Rear
Brake	Electro-Mechanical	Electro-Mechanical
Seat Type	Premium Upholstery Mid-Back w/ Headrest Swivel Seat-Sliding Adjustment	
Seat Width	455 mm / 18"	455 mm / 18"
Motor Size	500W 3100 r.p.m	700W 4500 r.p.m
Battery Size	(2) 24V. 36Ah	(2) 12V. 50Ah
Battery Weight	23 kg / 51 lbs	31.3 kg / 69 lbs
Travel Range	34 km / 21 Miles	42.5 km / 26.4 Miles
Battery Charger	5A Off Board	5A Off Board
Electronics	On/Off Key Switch, Battery Level Indicator, Speed Control Knob	
Reversing Width	620 mm	

*Subject to change without notice.

INSPECTION CHECKS

The following table lists inspection checks that should be performed by the user and their intervals. If the mobility device fails to pass one of the inspection checks, please contact your authorised drive dealer.

Maintenance Jobs	When Delivered	Weekly	Monthly
Seat and backrest padding:			X
- Check for perfect condition.			
Tyres:			
- Have tyres checked for specified air pressure (2,8 bar).	X	X	
Front wheels:			
- Front wheels must spin smoothly.		X	
- If wheels wobble or do not spin easily, adjust steering pivot pin or front wheel bearing.			X
Rear wheels:			
- Test wheel for firm seat on the axle drive shaft.			X
- Rear wheels must spin without wobbling			X
Electronics / Electrical System:			
- Check all plug connections for condition and firm connection.			X
- Have batteries been fully charged before the daily operation?	Before every trip		
- Are all holders, screws firmly fixed, tight and safe?			X
- Are all electric bulbs of the lighting system (if applicable) in working order?	Before each trip		
Cleaning:			
- Clean all parts carefully.	When necessary		



CERTIFICATE OF NEWNESS

**THIS DOCUMENT SHOULD BE SUBMITTED WITH THE V55/4 FORM
TO REGISTER THE VEHICLE WITH THE DVLA.**

Make	ST4D	ST4E
Type of Body	Metal and Plastic	Metal and Plastic
Serial Number		
Weight w/Batteries	100.7 kg / 222 lbs	87 kg / 191 lbs
Top Speed	12 kmph / 7.5 mph	8 kmph / 5 mph

I declare that the mobility scooter described above is new and unused, and has not been registered before.

Signed: *Mark Harris*

On behalf of Drive Medical Ltd

Date:

Drive Medical Ltd,
Ainley's Industrial Estate, Elland,
West Yorkshire HX5 9JP

Warranty Information

Drive Medical ST4D and ST4E Scooters are warranted for 12 months (24 months frame) from the date of purchase on side frames and crossbars. (NB Batteries are warranted for 12 months.)

- » During the warranty period any parts that have become defective due to faulty workmanship or material will be repaired or replaced without charge by Drive Medical supplier/dealer
- » The warranty excludes tyres, punctures and items that become worn due to normal wear and tear such as upholstery and armrest pads
- » The warranty excludes all items that have been subject to undue wear and tear and misuse
- » Unauthorised changes or modifications will forfeit your warranty
- » If a defect or fault is discovered, the Drive Medical supplier/dealer from whom the Wheelchair was purchased should be notified immediately

Limitation of Liability

The warranty does not extend to the consequential costs resulting from fault clearance, in particular freight and travel costs, loss of earnings, expenses, etc. The manufacturer will not accept responsibility for any damage or injury caused by misuse or non-observance of the instructions set out in this user manual.

Dealer Stamp



Drive Medical Ltd
North Road,
Bridgend Industrial Estate
Bridgend, CF31 3TP

Tel: +44 (0) 1656 664700

Fax: +44 (0) 1656 664727

Email: info@drivemedical.co.uk

www.drivemedical.co.uk