

*Since 1968*

**COMMAX**  
SmartHome & Security

# User Manual

Floor distributor CMD-404FU



[www.commax.com](http://www.commax.com)

COMMAX Co.,Ltd.



- Thank you for purchasing COMMAX products.
- Please carefully read this User's Guide (in particular, precautions for safety) before using a product and follow instructions to use a product exactly.
- The company is not responsible for any safety accidents caused by abnormal operation of the product.



## Contents

1. Introduction .....	2
2. Important Safeguard .....	3
3. Product Concept and Features .....	4
4. Wiring diagram .....	6
5. Configuration of DEVICE ID & mode .....	9
6. Specification.....	14



## 1. Introduction

Your unit is designed so it can be flush mounted on the or used. When flush mounted on the wall, the stand permits you to the unit for an gular of unit view. The model number is located on the bottom and record the serial number in the space provided below(available). Refer to these numbers whenever you call upon your COMMAX dealer regarding this product.

Model No.

Serial No.

**To prevent fire or shock hazard, do not expose the unit to rain or moisture.**



This symbol is intended to alert the use to the presence of uninsulated **"dangerous Voltage"** within the product' s enclose that may be of sufficient magnitude to constitute a risk of electric shock to persons.



This symbol is intended to alert the use to the presence of important operating and maintenance(servicing) instructions in the literature accompanying the appliance



caution

Risk of electric shock  
do not open



CAUTION : To reduce the risk of electric shock, do not remove cover(or back) no user-serviceable part inside refer servicing to qualified service personnel



## 2. Important Safeguards

- ▲ **Damage Requiring Service** : This equipment from the power source and source and refer servicing to qualified service personnel under the following conditions
  - ① when the power is damaged.
  - ② if liquid has been spoiled or objects have fallen into the unit
  - ③ if the equipment has been exposed to rain or water.
  - ④ if the equipment has been dropped or otherwise damaged.
  - ⑤ when the equipment exhibits a distinct change in performance- this indicates a need for service.
- ▲ **Water and Moisture** : Do not use this product near water, for example, near a bath tub, wash bowl, kitchen sink, or laundry tub, in a wet basement, or near a swimming pool, and the like.
- ▲ **Accessories** : The product may fall, causing serious injury to a child or adult, and serious damage to the appliance. Any mounting of the manufacture's instructions, and should use a mounting accessory recommended by the manufacturer.
- ▲ **Object and Liquid Entry** : Never push objects of any kind into this product through openings as they may touch dangerous voltage points or short-out parts that could result in a fire or electric shock. Never spill liquid of any kind on the product.
- ▲ **Lightning** : For added protection for this product before a lightning storm, or when it is left unattached and un used for long periods of time, unplug it from the wall outlet and disconnect the other system. This will prevent damage to the product due to lightning and power-line surges. If you live in an area heavily prone to lightning storms, it is recommended that you invest in power-line, telephone-line, RF cable and actuator / polarization surge protectors to protect your appliance system from possible damage



### 3. Product Concept and Features

- CMD-404FU building distributor is used to interlock with floor distributor (CMD-101BU) and is developed for interlocking Modum system monitor with lobby and security.
- CMD-404FU is limited to the following devices that can be connected to interlock  
Lobby phone : Export-oriented type LOBBY (Gate View , Multi panel) Floor distributor:  
Modum distributor (CMD-101BU) (Required) Video phone : The video phone for 4-wire way Modum system (CMV-43A), Adapter : RF-2A
- CMD-404FU Notes on wiring (It doesn't guarantee the quality of product for connection if you do not keep the following)
  - Wire the "IN" of CMD-404FU with distributor or, CMD-404FU installed with "OUT" on the floor below
  - Wire "LINE 1~4" of CMD-404FU with 2<sup>nd</sup> CCTV of MODUME system video phone. (Max 4 Houses connection)

- CMD-404FU distribute wires up four houses on one floor and output common 6 lines after receiving common 6 lines (DATA/GND/LB-TALK,A,B/VD\_P,N) from Distributor(CMD-101BU)
  - Maximum 40 CMD-404FU can be operated within 300 meter from lobby or CCTV.
  - The distant from floor distributor (CMD-404FU) to Modum System video phone is within 30m.
  - Separate power source must be connected to CMD-404FU.(DC24V / 80mA or higher)
  - Separate power must be connected to CMD-404FU.(DC24V / 80mA or higher) In case one source of power is used, then maximum devices connected should be Eight.
- 
- Floor distributor should be connected with 2<sup>nd</sup> terminal of camera (Caution: When interlocking or expanding with external device, do connect two or more video phone.



## 4. Wiring diagram

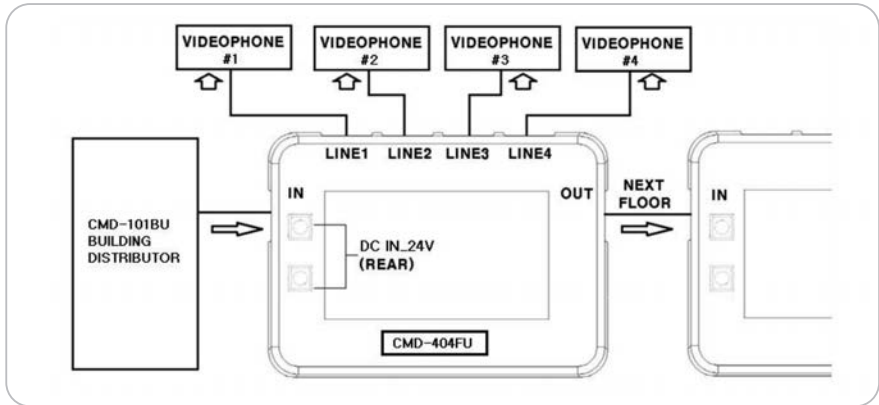

- CCTV / LOBBY → Building distributor(CMD-101BU) → CMD-404FU(1<sup>ST</sup> FLOOR) → CMD-404FU(1<sup>ST</sup> FLOOR) → CMD-404FU(2<sup>ND</sup> FLOOR) → ... → MODUME VIDEO PHONE  
: UTP CABLE [CAT.5e] - MAX 300m

**[CMD-404FU IN PORT]**

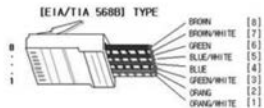
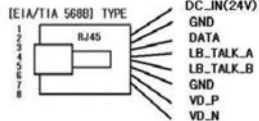

**[CMD-404FU LINE PORT]**

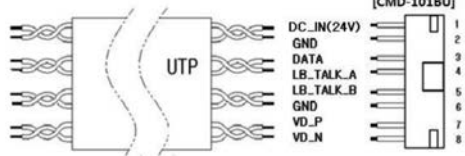
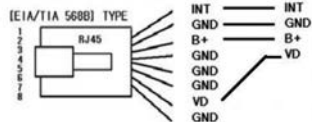

**[CMD-101BU]**

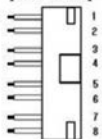

**[MODUME VIDEO PHONE]**

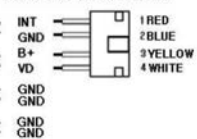



- OPTION (Use for easy connection: CMD-101BU/CCU-204AGF LINE BOARD)  
CASE : MODUM SYSTEM + AUDIO GATE SYSTEM

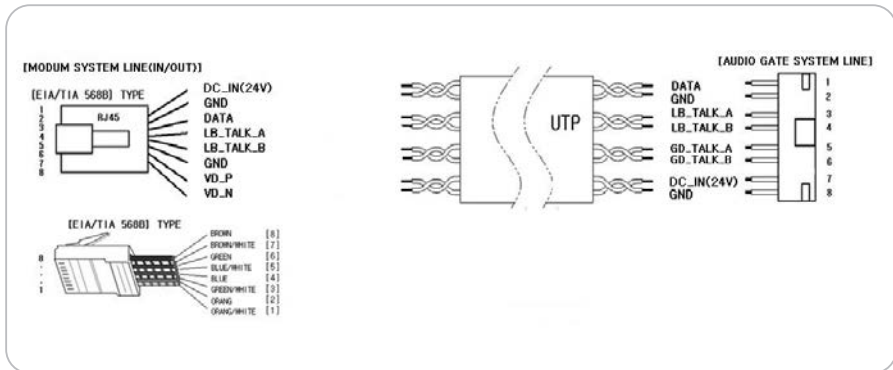



## 5. Configuration of DEVICE ID & mode

- When configuring the Device ID, set up Dip switch on the back panel of the product.  
(Different ID should be used when installing the multiple floor distributor.)
- Functions for each switches
  - # 1 (Select MANUAL /AUTO) : OFF= MANUAL / ON= AUTO
  - # 2 ~4 (ID configuration: 10 digit figure) : Composed of BCD code (Refer to picture below)
  - # 5~6 (ID configuration: single digit figure) : Composed of BCD code (Refer to picture below)

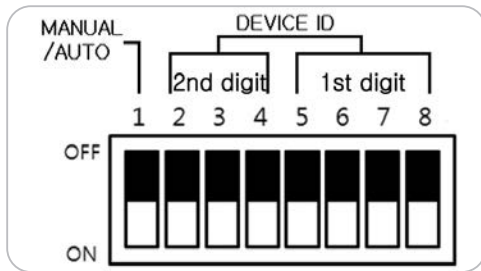

- Number description method by switches (There are three 10 digit figure switches which can be used to seven)

Number	How to set up	Number	How to set up
0	OFF ON 2 3 4	4	OFF ON 2 3 4
1	OFF ON 2 3 4	5	OFF ON 2 3 4
2	OFF ON 2 3 4	6	OFF ON 2 3 4
3	OFF ON 2 3 4	7	OFF ON 2 3 4

Number	How to set up	Number	How to set up
0	OFF ON 5 6 7 8	5	OFF ON 5 6 7 8
1	OFF ON 5 6 7 8	6	OFF ON 5 6 7 8
2	OFF ON 5 6 7 8	7	OFF ON 5 6 7 8
3	OFF ON 5 6 7 8	8	OFF ON 5 6 7 8
4	OFF ON 5 6 7 8	9	OFF ON 5 6 7 8

["Enter ten digit number : 0~7]

["Enter single digit number: 0~9]

\*\* ID configuration range: 1 ~ 79(MAX) room number can be entered. \*\*

- Auto / Manual mode function

① Auto Mode (ON): When booted with number one switch on, it operates with auto mode.

Room numbers are allocated sequentially by the ID number configured.

(Building # is fixed as #101, designated ID X '4' will be final channel of room #)

Ex) When ID = 1 configured

Channel 1 (Line1) = Block 101 unit 1

Channel 2 (Line2) = Block 101 unit 2

Channel 3 (Line3) = Block 101 unit 3

Channel 4 (Line4) = Block 101 unit 4

(1(ID#) X 4 = 4[ Last channel unit number is designated as 4])

Ex) ID = 79(max) configured

Channel 1 (Line1) = Block 101 unit 313

Channel 2 (Line2) = Block 101 unit 314

Channel 3 (Line3) = Block 101 unit 315

Channel 4 (Line4) = Block 101 unit 316( 79(ID#) X 4 = 316

[Last channel unit number is designated as 316]

\*\* Reference: On Auto Mode block number is fixed as 101.\*\*

- ② Manual Mode (OFF): When booted with number 1 switch off, it operates on MANUAL mode. Irrelevant to ID number configured, you can directly set up the block and unit number from external device(Lobby phone)

### **Caution**

- ① **You can only set up MANUAL Mode from separate lobby phone (program mode supported 36**
- ② **After DEVICE ID and mode is set, it should be booted with adapter power OFF/ON  
If there was a connection of the common power, it should be reconnected after the “IN” PORT UTP cable was disconnecte**

When you register the lobby information to floor distributor from the lobby phone, this floor distributor will be set with the building No. of lobby phone.

After that, the household unit which is connected with this floor distributor can check the image of lobby phone during monitoring mode

- Initialization

When you turn on the product after you set up all switch on or off, then factory reset will be initiated.

(Initial value = Block101 Unit 1(line1), Unit 2(line2), Unit 3 (line3), Unit 4 (line4) )

**Caution : Product only operates after OFF/ON when configured.**



## 6. Specification

Spec	Model	CMD-404FU [Floor Distributor]
Transmission type		Building distributor(CMD-101BU) 6 lines (Polarity), MODUME
		VIDEO-PHONE 4 lines (Polarity)
		(RJ45 CAT5e Patch Cable)
Voltage		DC 24V / 80mA (MAX)
Wiring Sequence		1. MODUM System building distributor(CMD-404FU) → CMD-404FU IN (Input)
		2. CMD-404FU OUT(Output) → Upstairs CMD-404FU IN (Expansio
		3. CMD-404FU LINE1,2,3,4 → Monitor (MODUM System video phone)
Wiring distance		Maximum 300m : Main entrance →
		monitor, the distance from each floor
		distributor to each monitor is limited by 30m.
		(One line per lobby, 40 floor distributor can be interlocked)



## MEMO

A large, empty rectangular box with rounded corners, intended for writing a memo.





## MEMO

A large, empty rectangular box with rounded corners, intended for writing a memo.

**COMMAX**

**COMMAX Co.,Ltd.**

513-11, Sangdaewon-dong, Jungwon-gu, Seongnam-si, Gyeonggi-do, Korea  
Int'l Business Dept. : Tel.; +82-31-7393-540~550 Fax.; +82-31-745-2133  
Web site : [www.commax.com](http://www.commax.com)

PM99404FU010

Printed In Korea / 2014.10.105