

User's Guide

Laser Diode Precision Pulsed Supply LDP-3811



 **ILX Lightwave**
Photonic Test and Measurement

ILX Lightwave Corporation • P. O. Box 6310 • Bozeman, MT, U.S.A. 59771 • U.S. & Canada: 1-800-459-9459 • International Inquiries: 406-556-2481 • Fax 406-586-9405

ilx.custhelp.com • www.ilxlightwave.com



TABLE OF CONTENTS



Safety Information and the Manual xi
 General Safety Considerations xi
 Safety Marking Symbolsxii
 Comments, Suggestions, and Problems xiv

Chapter 1 Introduction and Specifications

Product Overview 1
 Available Options and Accessories 1
Specifications¹ 2

Chapter 2 Installation and Configuration

Installation 5
 AC Power Considerations 5
 Tilt-Foot Adjustment 6
 Rack Mounting 6
Power-Up Sequence 6
Introduction to the LDP-3811 Front Panel 8
 Front Panel Familiarization 8
 General Functions 9
 MODE Functions 9
 OUTPUT Function 9
 GPIB Section 10
 ADJUST Section 10
 MODE Section 10

MODE SELECT	11
MODE Indicators	11
Continuous Wave (CW) Mode	11
Constant Duty Cycle Percent (CONST %) Mode	11
Constant Pulse Repetition Interval (CONST PRI) Mode	12
External Trigger (EXT TRIG) Mode	12
DISPLAY Switch Section	13
DISPLAY Indicators and Switches	13
PARAMETER SETUP Section	13
PARAMETER SETUP SELECT Switch	14
SET Switch	14
LIM Parameters	14
SAVE and RECALL Parameter Functions	15
RANGE Selection	15
Error Indicators	17
Back Panel Controls and Connections	18
The OUTPUT Connectors	18
Connecting to Your Laser	18
Laser Diode Connections and Shielding	19
TRIGGER Connectors	19
GPIB Connector	20
KEYLOCK Switch	20
AC Power Entry Module and Fuse	20
Chassis Ground	20
General Operating Procedures	21
Warm-up and Environmental Considerations	21
Pulse Mode Operation	21
CW Mode Operation	23
TRIGGER OUT Operation	24
 Chapter 3 Command Reference	
Overview of the 3811 Command Set	26
Substitute Parameter Names	26
Compound Command Structure	26
Common Commands	29
3811 Device-Dependent Commands	30

Command Paths 31
 3811 Device-Command Reference 32
Error Messages 73
LDP-3811 Programming Examples 73

Chapter 4 GPIB/IEEE-488.2 Remote Operation

Introduction 75
 Preparation for Bus Control 76
Getting Started with GPIB 77
 Overview of the 3811 Syntax 77
 Using Commands with Parameters 78
Common Commands and Queries 79
 *CAL? 79
 *CLS 79
 *DLF 79
 *ESE 80
 *ESE? 80
 *ESR? 81
 *IDN? 81
 *IST? 81
 *OPC 82
 *OPC? 82
 *PRE 82
 *PRE? 83
 *PSC 84
 *PSC? 84
 *PUD 85
 *PUD? 85
 *RCL 85
 *RST 86
 *SAV 87
 *SRE 87
 *SRE? 88

*STB?	89
*TST?	89
*WAI	89
Advanced Programming	90
Path Specification	90
Error Messages	91
ANSI/IEEE-488.2 Definitions	92
Syntax Diagrams	92
White Space	92
Power-on Conditions	93
<nrf value>	93
<PROGRAM MESSAGE TERMINATOR>	94
<PROGRAM MESSAGE UNIT SEPARATOR>	94
<PROGRAM HEADER SEPARATOR>	94
<compound command program header>	95
<PROGRAM DATA> (Parameters)	96
<ARBITRARY BLOCK PROGRAM DATA>	96
<PROGRAM DATA SEPARATORS>	97
Default Parameters	97
Status Reporting	98
Event and Condition Registers	98
Operation Complete Definition	98
Command Timing and Completion	100
Output Off Register	102
Input Buffer and Output Data	102
Remote Interface Messages	103
Interface Function Subsets	103
3811 Remote Messages	104
Non-Supported Remote Interface Messages	104



Chapter 5 Maintenance

Calibration Overview	105
Recommended Equipment	106
Environmental Conditions	106
Warm-Up	106
Cleaning	106
Local Operation Current Source Calibration	107
Remote Operation Current Source Calibration	108
Fuse Replacement	109

Chapter 6 Troubleshooting

Appendix A Error Messages

Appendix B Quick Start

Installation	117
Setup the OUTPUT Parameters	117
Initialize Test Mode Parameters	118
Connect to the Laser	118
Saving Changes	119
More Information	119

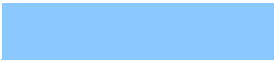
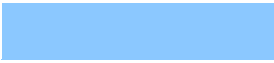

TABLE OF CONTENTS

LIST OF TABLES

Table 2.1	LDP-3811 Default Settings.	7
Table 2.2	Error Indicators.	17
Table 3.1	Substitute Parameter Names.	28
Table 3.2	LDP-3811 Device-Dependent Commands.	29
Table 4.1	State of the 3811 After *RST	56
Table 4.2	3811 Interface Function Subsets	62
Table 4.3	3811 Allowable GPIB Interface Messages.	63
Table 4.4	Non-Supported Interface Messages for the 3811	63
Table 5.1	Recommended Test Equipment.	66
Table 5.2	Fuse Replacement.	69
Table A.1	Error Code Classifications.	73
Table A.2	Error Message Codes	74



LIST OF TABLES

LIST OF FIGURES

Figure 2.1	LDP-3811 Front Panel	8
Figure 2.2	LDP-3811 MODE Section	11
Figure 2.3	LDP-3811 DISPLAY Switch Section	12
Figure 2.4	LDP-3811 PARAMETER SETUP Section	13
Figure 2.5	Error Indicators	17
Figure 2.6	LDP-3811 Back Panel	18
Figure 2.7	Back Panel 9-Pin OUTPUT Connector	19
Figure 3.1	Command Description Format	32
Figure 3.2	Command Path Structure	33
Figure 3.3	Step and Delay Example Program	75
Figure 3.4	Constant Duty Cycle Example Program	76
Figure 4.1	Standard Event Status Register / Standard Event Status Enable Register	82
Figure 4.2	Parallel Poll Response Handling Data Structure	85
Figure 4.3	Service Request Enable Register	90
Figure 4.4	White Space Syntactic Diagram	94
Figure 4.5	<PROGRAM MESSAGE TERMINATOR> Syntax Diagram	96
Figure 4.6	<PROGRAM MESSAGE UNIT SEPARATOR> Syntax Diagram	96
Figure 4.7	<PROGRAM HEADER SEPARATOR> Syntax Diagram	97
Figure 4.8	<compound command program header> Syntax Diagram	97
Figure 4.9	<compound query program header> Syntax Diagram	97
Figure 4.10	<ARBITRARY BLOCK PROGRAM DATA> Syntax Diagram	98

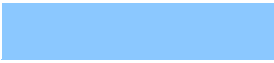

LIST OF FIGURES

Figure 4.11	<PROGRAM DATA SEPARATOR> Syntax Diagram	99
Figure 4.12	LDP-3811 Status Reporting Schematic Diagram	101
Figure 4.13	3811 Output Off Register	104
Figure 5.1	Power Line Voltage Selection	112

SAFETY AND WARRANTY INFORMATION

The Safety and Warranty Information section provides details about cautionary symbols used in the manual, safety markings used on the instrument, and information about the Warranty including Customer Service contact information.

Safety Information and the Manual

Throughout this manual, you will see the words *Caution* and *Warning* indicating potentially dangerous or hazardous situations which, if not avoided, could result in death, serious or minor injury, or damage to the product. Specifically:

CAUTION

Caution indicates a potentially hazardous situation which can result in minor or moderate injury or damage to the product or equipment.

WARNING

Warning indicates a potentially dangerous situation which can result in serious injury or death.

WARNING

Visible and/or invisible laser radiation. Avoid direct exposure to the beam.

General Safety Considerations

If any of the following conditions exist, or are even suspected, do not use the instrument until safe operation can be verified by trained service personnel:

- Visible damage
- Severe transport stress
- Prolonged storage under adverse conditions
- Failure to perform intended measurements or functions

If necessary, return the instrument to ILX Lightwave, or authorized local ILX Lightwave distributor, for service or repair to ensure that safety features are maintained (see the contact information on page xiv).

All instruments returned to ILX Lightwave are required to have a Return Authorization Number assigned by an official representative of ILX Lightwave Corporation. See Returning an Instrument on page xiii for more information.

SAFETY SYMBOLS











This section describes the safety symbols and classifications.

Technical specifications including electrical ratings and weight are included within the manual. See the Table of Contents to locate the specifications and other product information. The following classifications are standard across all ILX Lightwave products:

- Indoor use only
- Ordinary Protection: This product is NOT protected against the harmful ingress of moisture.
- Class I Equipment (grounded type)
- Mains supply voltage fluctuations are not to exceed $\pm 10\%$ of the nominal supply voltage.
- Pollution Degree 2
- Installation (overvoltage) Category II for transient overvoltages
- Maximum Relative Humidity: $< 80\%$ RH, non-condensing
- Operating temperature range of $0\text{ }^{\circ}\text{C}$ to $40\text{ }^{\circ}\text{C}$
- Storage and transportation temperature of $-40\text{ }^{\circ}\text{C}$ to $70\text{ }^{\circ}\text{C}$
- Maximum altitude: 3000 m (9843 ft.)
- This equipment is suitable for continuous operation.

Safety Marking Symbols

This section provides a description of the safety marking symbols that appear on the instrument. These symbols provide information about potentially dangerous situations which can result in death, injury, or damage to the instrument and other components.

	Caution, refer to manual		Earth ground Terminal		Alternating current		Visible and/or invisible laser radiation
	Caution, risk of electric shock		Protective Conductor Terminal		Caution, hot surface		Frame or chassis Terminal
	On: In position of a bistable push control. The slash (I) only denotes that mains are on.				Off: Out position of a bistable push control. The circle (O) only denotes that mains are off.		
	or (I)				or (O)		

WARRANTY

ILX LIGHTWAVE CORPORATION warrants this instrument to be free from defects in material and workmanship for a period of one year from date of shipment. During the warranty period, ILX will repair or replace the unit, at our option, without charge.

Limitations

This warranty does not apply to fuses, lamps, defects caused by abuse, modifications, or to use of the product for which it was not intended.

This warranty is in lieu of all other warranties, expressed or implied, including any implied warranty of merchantability or fitness for any particular purpose. ILX Lightwave Corporation shall not be liable for any incidental, special, or consequential damages.

If a problem occurs, please contact ILX Lightwave Corporation with the instrument's serial number, and thoroughly describe the nature of the problem.

Returning an Instrument

If an instrument is to be shipped to ILX Lightwave for repair or service, be sure to:

- 1 Obtain a Return Authorization number (RA) from ILX Customer Service.
- 2 Attach a tag to the instrument identifying the owner and indicating the required service or repair. Include the instrument serial number from the rear panel of the instrument.
- 3 Attach the anti-static protective caps that were shipped with the instrument and place the instrument in a protective anti-static bag.
- 4 Place the instrument in the original packing container with at least 3 inches (7.5 cm) of compressible packaging material. **Shipping damage is not covered by this warranty.**
- 5 Secure the packing box with fiber reinforced strapping tape or metal bands.
- 6 Send the instrument, transportation pre-paid, to ILX Lightwave. Clearly write the return authorization number on the outside of the box and on the shipping paperwork. ILX Lightwave recommends you insure the shipment.

If the original shipping container is not available, place your instrument in a container with at least 3 inches (7.5 cm) of compressible packaging material on all sides.

Repairs are made and the instrument returned transportation pre-paid. Repairs are warranted for the remainder of the original warranty or for 90 days, whichever is greater.

Claims for Shipping Damage

When you receive the instrument, inspect it immediately for any damage or shortages on the packing list. If the instrument is damaged, file a claim with the carrier. The factory will supply you with a quotation for estimated costs of repair. You must negotiate and settle with the carrier for the amount of damage.

Comments, Suggestions, and Problems

To ensure that you get the most out of your ILX Lightwave product, we ask that you direct any product operation or service related questions or comments to ILX Lightwave Customer Support. You may contact us in whatever way is most convenient.

In the United States:

Phone (800) 459-9459 or (406) 586-1244
 Fax (406) 586-9405
 Online: <http://ilx.custhelp.com>
 Email: support@ilxlightwave.com

Or mail to:

ILX Lightwave Corporation
 P. O. Box 6310
 Bozeman, Montana, U.S.A 59771
www.ilxlightwave.com

In Europe:

Optical Test and Calibration Ltd.
 Listerhills Science Park
 Bradford, BD7 1HR United Kingdom
 Phone: (44) 1274 393857
 Fax: (44) 1274 393336
 Online: www.otc.co.uk
 Email: sales@otc.co.uk

In Japan:

Kyosai Technos
 424, Shimo-Ongata-Machi
 Hachioji-Shi
 Tokyo, 192-0154 Japan
 Phone: (81) 426 521 388
 Fax: (81) 426 513 270

In China:

ETSC Technologies Co.
 9/F Building 1
 SBI Street
 Dongxin Road
 East Lake High-Tech Development Zone
 Wuhan, Hubei, 430074 PRC China
 Phone: (86) 27 8717 0152; (86) 27 8741 2681; (86) 27 8780 7925
 Fax: (86) 27 8780 7133
 Online: www.etsc-tech.com
 Email: sales@etsc-tech.com

In China:

Kyosai Technos
 3F Bldg G, No.21 Changjiang Road, Wuxi
 National Hi-Tech Development Zone
 Jiangsu, P.R. China
 Phone: (86) 510 522 1707
 Fax: (86) 510 522 1679
 Email: ilx-service-china@kyosaitec.co.jp

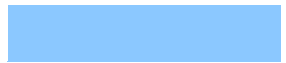

When you contact us, please have the following information:

Model Number: _____

Serial Number: _____

End-user Name: _____

Company: _____

Phone: _____

Fax: _____

Description of what is connected to the ILX Lightwave instrument:

Description of the problem:

If ILX Lightwave determines that a return to the factory is necessary, you are issued a Return Authorization (RA) number. Please mark this number on the outside of the shipping box.

You or your shipping service are responsible for any shipping damage when returning the instrument to ILX Lightwave; ILX recommends you insure the shipment. If the original shipping container is not available, place your instrument in a container with at least 3 inches (7.5 cm) of compressible packaging material on all sides.

We look forward to serving you even better in the future!



WARRANTY

INTRODUCTION AND SPECIFICATIONS



This manual contains operation and maintenance information for the LDP-3811 Laser Diode Precision Pulsed Supply and optional Model 1231 GPIB/IEEE-488.2 Interface. If you want to get started right away, read Appendix B (Quick Start) first. Chapter 2 has a section for quick familiarization of the LDP-3811 front panel and also provides an in-depth operation reference.

Product Overview

Specifically designed to drive low power diodes, the LDP-3811 is a microprocessor controlled current source which can operate in CW mode or precision pulse mode. This instrument offers a dual range of 200/500 mA output, programmable Pulse Width, Duty Cycle and Pulse Repetition Interval (period). Laser diode protection was designed into the instrument with programmable current limits for both ranges, error indication and protection and power line transient protection. Remote control of the instrument is offered with the GPIB/IEEE-488.2 interface. To close the loop with other lab measurement instruments, the LDP-3811 can send and receive a TTL level compatible trigger.

Available Options and Accessories

DESCRIPTION	MODEL NUMBER
Rack mount flange kit (enables installation into a standard 19" wide rack)	124
Current Source / Laser Diode Mount Interconnect Cable	303

Specifications¹

Pulse Amplitude	
Range	0 - 200 mA / 0 - 500 mA, floating ²
Resolution - Front Panel	100 μ A
Resolution - GPIB	10 μ A
Accuracy ³	$\pm 0.5\%$ FS
Temperature Coefficient	< 100 ppm
Compliance Voltage	> 25 V
Overshoot 50 mA $\leq I < I_{max}$ I < 50 mA	< $\pm 5\%$ < $\pm 2\%$
CW Current Output	
Range	0 - 200 mA / 0 - 500 mA floating
Resolution	10 μ A
Accuracy	$\pm 0.5\%$ FS
Temperature Coefficient	< 100 ppm / $^{\circ}$ C
Stability, for 10 minutes ⁴	< 100 ppm
Stability, for 24 hours ⁵	< 200 ppm
Compliance Voltage	≥ 25 V
Noise and Ripple	< 200 μ A rms
Pulse Width	
Range	0.1 to > 1000 μ s
Resolution	100 nSec
Accuracy	10 nSec $\pm 0.01\%$ of reading
Pulse Rise / Fall Time ⁶	< 25 ns
Pulse Repetition Interval (PRI)	
Range	1 to > 1000 μ s
Resolution	100 ns
Accuracy	20 ns $\pm 0.01\%$ of reading
Duty Cycle	0.01% to 100%

Trigger Output	
Type	TTL
Jitter	± 5 nSec
Delay	40 nSec ± 10 nSec
Trigger Input	
Type	TTL
Jitter	± 100 nSec
Delay	200 nSec ± 20 nSec
Connectors	
Current Source Connectors	9-pin D-sub and BNC connectors
External Trigger Input	BNC connector
External Trigger Output	BNC connector
Chassis Ground Post	Banana-type
GPIB	488.1-1987 standard
General	
Size	3.5" x 8.4" x 10.6" 88mm x 212mm x 269mm
Weight	5.2 kg (11.5 lbs)
Power Requirements	50-60 Hz 100 / 120 VAC 220 / 240 VAC
Operating Temperature	0 to +40 °C
Storage Temperature	-40 to +70 °C
Humidity	< 95% relative humidity, non-condensing
GPIB	IEE488
Safety	21 CFR 1040.10 keyswitch interlock
Regulatory Compliance	CE Certification EMC Directive 2004/108 EC per Standard EN 61326-1:2006; Low Voltage Directive 2006/96/EC per Standard EN 61010-1:2001

1. All specifications measured after a one hour warm-up period at 25°C.
2. Grounding the laser diode cathode degrades pulse performance.
3. Measured after a 2 usec settling time.
4. Over any 10 minute interval, half scale output.
5. Over a 24 hour period, half scale output.
6. Measured from 10% to 90% points at half scale output.

Our goal is to make the best laser diode instrumentation available anywhere. To achieve this, we need your ideas and comments on ways we can improve our products. We invite you to contact us at any time with your suggestions.

INSTALLATION AND CONFIGURATION

This chapter describes how to install, adjust, and operate the LDP-3811. It is divided into five sections covering introduction, installation, familiarization and adjustment of the LDP-3811, warm-up and environmental considerations, and normal operating procedures.

This chapter gives an overview of the LDP-3811's front panel features, and it presents a guide to quickly familiarize the user with the front panel operations.

Appendix B, Quick Start, is intended for users who wish to begin operation right away. It contains the minimum information required to safely drive a laser diode with the LDP-3811.

Installation

AC Power Considerations

The LDP-3811 can be configured to operate at nominal line voltages of 100/120 / 220-230/240 VAC. This is set internally at the factory and should not be changed. However, check to be sure that the voltage printed on the back panel of the instrument matches the power-line voltage in your area.



WARNING

To avoid electrical shock hazard, connect the instrument to properly earth-grounded, 3-prong receptacles only. Failure to observe this precaution can result in severe injury or death.

Tilt-Foot Adjustment

The LDP-3811 has front legs that extend to make it easier to view the LED displays. To use them, place the LDP-3811 on a stable base and rotate the legs downward until they lock into position.

Rack Mounting

The LDP-3811 may be rack mounted by installing a rack mount flange on either side of the enclosure. All rack mount accessory kits contain detailed mounting instructions. Refer to Section 1.3 for applicable rack mount accessory part numbers.

Power-Up Sequence

With the LDP-3811 connected to an AC power source, pressing the POWER switch will supply power to the instrument and start the power-up sequence.

During the power-up sequence, the following takes place. For about 3 seconds a lamp test is conducted. During the lamp test all indicators light up for about 3 seconds, and all of the 7-segment displays indicate "8".

Then, a self-test is performed to ensure that the LDP-3811's hardware and software are communicating. If the LDP-3811 cannot successfully complete this test, an error message of E512 will be displayed. See Appendix A for an explanation of error messages.

After this test, the LDP-3811 will display its firmware version number for three seconds. Then the LDP-3811 is configured to the state it was in when the power was last shut off.

The user may choose to "clear" the parameters that appear by recalling "BIN 0" either manually (see Section 2.4.6.4) or through the GPIB (see Section 4.3.17). When "BIN 0" is called, the front panel will be in the following state:

<p>GPIB mode in LOCAL via front panel, or in REMOTE via GPIB</p> <p>PARAMETER SETUP is not selected</p> <p>LIM 200 (200 mA range) = 200 mA</p> <p>LIM 500 (500 mA range) = 500 mA</p> <p>OUTPUT off</p> <p>MODE - CONST % (constant duty cycle %)</p> <p>Pulse Width (PW) = 0.1 uSec</p> <p>Pulse Repetition Interval (PRI) = 1.0 uSec</p> <p>Duty Cycle % - 10.0%</p> <p>Display showing current (in mA)</p> <p>RANGE in 200 mA setting</p> <p>Set Point = 0 mA</p> <p>RECALL BIN number = 0</p> <p>STEP value = 0.01 mA</p>

Table 2.1 LDP-3811 Default Settings

Introduction to the LDP-3811 Front Panel

The LDP-3811 front panel contains displays and controls for the OUTPUT controller hardware. Each of the labeled areas on the front panel (i.e. GPIB, PARAMETER SETUP, MODE or OUTPUT) and the display and adjustment sections of the front panel, is described in a separate section of this chapter.

Generally, the controls are simple to operate. The setup parameters, however, are intentionally a bit harder to use so that their values are not inadvertently changed.

Note: Later in this chapter, there is a quick introduction to the front panel functions by briefly describing the switches and indicators.

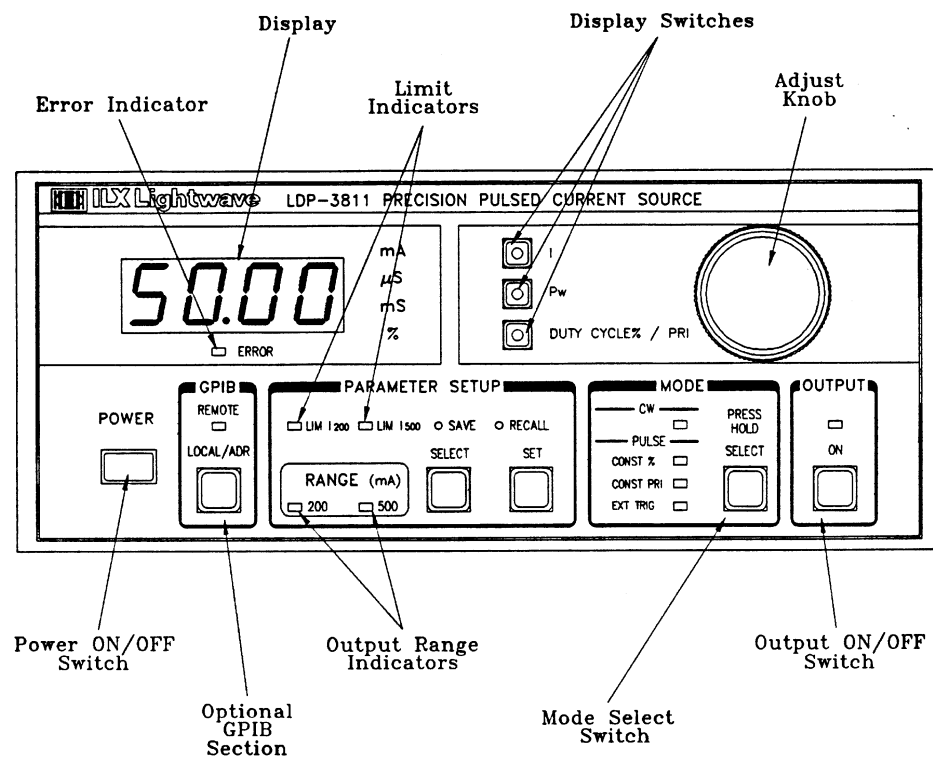

Figure 2.1 LDP-3811 Front Panel

Front Panel Familiarization

Refer to Figure 2.1 for the following discussions of the LDP-3811 front panel sections. The key words are in bold for easy identification.

General Functions

The **GPIB section** is used when the optional remote GPIB operations are implemented.

The **POWER** switch is used to power-up and power-down the LDP-3811.

The ADJUST knob, used for entering values, is the large knob on the LDP-3811 front panel. To the left of the ADJUST knob are the display switches, **I**, **PW**, and **DUTY CYCLE% / PRI**. These switches select which parameter is to be displayed on the LDP-3811's digital display.

The **PARAMETER SETUP section** contains the RANGE selection. Pressing the (PARAMETER SETUP) SELECT switch will cycle through the parameters. The (PARAMETER SETUP) SET switch is used to enter the SET mode for changing parameter values.

The **SAVE** and **RECALL** parameter functions are used to quickly configure the LDP-3811 parameters to user-determined preset values.

When the LDP-3811 is powered-up, the parameters will automatically be restored to the same values that were present at the last power-down. Furthermore, all of the saved setups will be "remembered", and easily recalled.

MODE Functions

When the **MODE SELECT** switch is pressed and held in for 3 seconds, the MODE indicator will flash. Then, when the switch is released, the MODE will then switch between CW and Pulse modes. If the switch is pressed for less than 3 seconds and then released, the MODE will either stay on CW or cycle to the next Pulse MODE, in a round-robin fashion.

OUTPUT Function

When the **(OUTPUT) ON** switch is pressed, and the indicator is lit, the laser drive current will be enabled. After a delay of 2 seconds, the OUTPUT current will be turned on to the set point value. During the 2 second delay, and whenever the OUTPUT is on (indicator lit), the I (drive current) display shows the measured value.

When the OUTPUT is off, the I (drive current) display shows the measured current value until the ADJUST knob is turned. When the ADJUST knob is turned while the I indicator is lit and the OUTPUT is off, the I display shows the set point current. The set point will remain on the I display for three seconds after the ADJUST knob is released.

Note: These conditions will automatically shut off the OUTPUT:

- Interlock Open (Pins 1 and 2 on the 9-pin D-sub OUTPUT connector)
- KEYLOCK switch in “disabled” position
- Laser Drive Current Voltage Limit / Open Circuit (While Output On)
- Change of MODE or RANGE
- At RECALL of pre-configured state
- Laser Drive Current Source Failure

GPIB Section

The GPIB section is located next to the POWER switch at the left side of the LDP-3811 front panel (see Figure 2.1).

The GPIB section contains the LOCAL/ADR switch and the REMOTE indicator. The functions of the indicator and switch are related to GPIB operations, as described below.

The **LOCAL/ADR** switch is used for several functions. When the LDP-3811 is in REMOTE mode, pressing the LOCAL switch returns the LDP-3811 to LOCAL control mode unless the Local Lockout state has been activated by the host computer. (Local Lockout disables all LDP-3811 front panel switches until this condition is changed by the host computer.) When the unit is in LOCAL mode, pressing the LOCAL/ADR switch causes the GPIB address to be displayed, e.g. “-01-”, and the GPIB address may be changed by turning the ADJUST knob while also pressing the (PARAMETER SETUP) SET switch. The usable GPIB address range is 0 - 30.

The **REMOTE indicator** is lit when the LDP-3811 is in GPIB remote mode. When the LDP-3811 is put in Local Lockout Mode by the host computer, the REMOTE indicator will flash at a 1 Hz rate to indicate that the front panel is completely disabled by Local Lockout.

ADJUST Section

The ADJUST section is located on the right side of the LDP-3811 front panel. It consists of the ADJUST (control) knob. The **ADJUST knob** is used to change the set points, enter parameter values, enter the GPIB address, or enter instrument calibration data.

MODE Section

The (MODE) SELECT switch determines which mode is used for the output of the current source. One of the following may be selected at one time: Continuous Wave (CW); or one of three pulsed modes, Duty Cycle % (CONST %), Pulse Repetition Interval (PRI), or External Trigger (EXT TRIG) mode

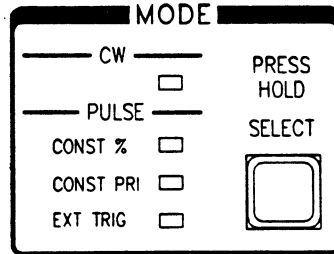

Figure 2.2 LDP-3811 MODE Section

MODE SELECT

The **(MODE) SELECT** switch is used to select one of the four available operating modes, Continuous Wave (CW), Constant Duty Cycle % (CONST %), Constant Pulse Repetition Interval (CONST PRI), or External Trigger (EXT TRIG). When a mode is selected, the corresponding LED becomes lit.

To switch from CW to a PULSE mode, or vice versa, the (MODE) SELECT switch should be held in for three seconds. After the (MODE) SELECT switch is held in for three seconds, the present MODE indicator will begin to flash. If the (MODE) SELECT switch is released before three seconds, the MODE will either stay in CW mode (if already there) or cycle to the next PULSE mode. Whenever the (MODE) SELECT switch is pressed, the OUTPUT is forced off.

MODE Indicators

The **CW indicator** becomes lit when the LDP-3811 is in the Continuous Wave (DC) mode. When CW mode is selected, the laser drive current output is controlled to the laser drive current (I) set point value.

Continuous Wave (CW) Mode

During operation in CW mode, the PW and DUTY CYCLE % / PRI display switches are disabled. When this mode is selected, the display will automatically return to displaying the laser drive current, (I).

Constant Duty Cycle Percent (CONST %) Mode

During operation in Constant Duty Cycle (CDC) Percent mode, the Pulse Width and/or Duty Cycle Percent may be edited. The actual PRI (Pulse Repetition Interval) will automatically be adjusted to create the desired Duty Cycle, independent of the PRI setting. When the DUTY CYCLE % / PRI display switch is pressed, the display will show Duty Cycle Percentage.

The duty cycle, pulse width and pulse repetition interval have the following relationship:

$$CDC = (PW / PRI) * 100$$

In CONST % mode, if a new Pulse Width is selected, the CDC value may be forced to change (due to the limited resolution of PW and PRI). The set point Duty Cycle % will be adjusted automatically to match the actual. For example, if CDC was 11.00%, and PW was then set to 0.1 uSec, CDC would be forced to 10.00% because PRI cannot be less than 1.0 uSec. Likewise, if the Duty Cycle % is changed, the LDP-3811 will automatically allow only valid Duty Cycle % values (based on the present PW value) to be selected.

Constant Pulse Repetition Interval (CONST PRI) Mode

During operation in Constant Pulse Repetition Interval (PRI) mode, the Pulse Width and/or Pulse Repetition Interval may be edited. When the DUTY CYCLE % / PRI display switch is pressed, the display will show the Pulse Repetition Interval. The minimum PRI is automatically limited to the existing PW value.

In this mode, adjusting the Pulse Width will cause the actual Duty Cycle % to be adjusted automatically, independent of the constant Duty Cycle % setting.

External Trigger (EXT TRIG) Mode

During operation in External Trigger mode, the Pulse Width may be edited. The DUTY CYCLE % / PRI switch is disabled in this mode. The Pulse Repetition Interval and Duty Cycle % are not used. Instead, the repetition interval is determined by the rate at which the trigger is fired via a TTL signal at the back panel TRIGGER IN connector.

The output trigger pulse width is the same as the Pulse Width (PW) value.

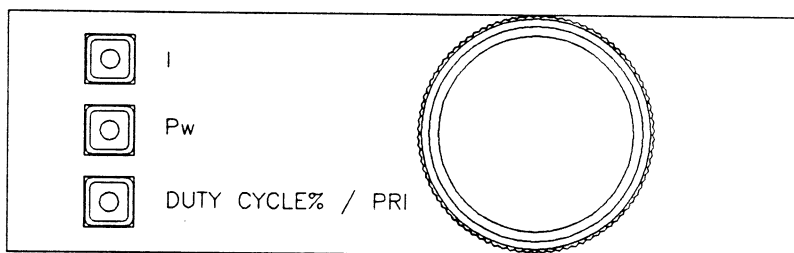

Figure 2.3 LDP-3811 DISPLAY Switch Section

DISPLAY Switch Section

The DISPLAY switch section is used to select the laser drive current (I), pulse width (PW), pulse repetition interval (DUTY CYCLE % / PRI) when in CONST PRI mode, or duty cycle percent (DUTY CYCLE % / PRI) when in CONST % mode.

DISPLAY Indicators and Switches

Pressing the **I switch** causes the laser drive output current to be displayed. Normally, the display will show measured laser drive output current, in mA. If the ADJUST knob is turned, or the I switch is pressed, the display will show the laser drive current set point value, in mA. The **I indicator** becomes lit when laser drive current is displayed.

Pressing the **PW switch** causes the output pulse width to be displayed, if the LDP-3811 is in CONST %, CONST PRI, or EXT TRIG mode. If the LDP-3811 is in CW mode, the PW switch is disabled. The **PW indicator** becomes lit when pulse width is displayed.

Pressing the **DUTY CYCLE % / PRI** switch causes the PRI (pulse repetition interval) or duty cycle percentage to be displayed, if the LDP-3811 is in CONST PRI or CONST % mode, respectively. If the LDP-3811 is in CW or EXT TRIG mode, the DUTY CYCLE % / PRI switch is disabled. The **DUTY CYCLE % / PRI** indicator becomes lit when PRI or duty cycle % is displayed.

PARAMETER SETUP Section

The following sections describe the function and form of the PARAMETER SETUP Selections.

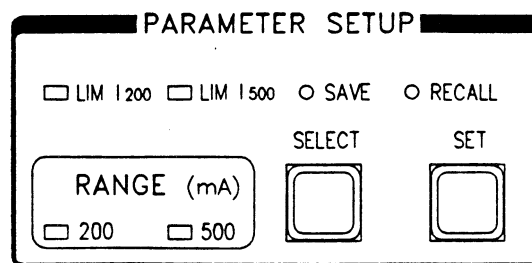

Figure 2.4 LDP-3811 PARAMETER SETUP Section

PARAMETER SETUP SELECT Switch

The **(PARAMETER SETUP) SELECT switch** is used to select the laser drive current limit (LIM), SAVE and RECALL, and RANGE parameters. When these parameters are selected, their present value will be displayed on the digital display. The selected parameter may be edited by then pressing the SET switch.

When the (PARAMETER SETUP) SELECT mode is first entered, the LIM 200 indicator becomes lit, and the LDP-3811 displays the current limit value for the 200 mA range, in mA. If the (PARAMETER SETUP) SELECT switch is released, the select mode continues for three seconds, during which the selected parameter remains displayed, and SET mode may be entered. After three seconds, the LDP-3811 reverts to the state which existed before the (PARAMETER SETUP) SELECT mode was entered.

If the (PARAMETER SETUP) SELECT switch is pressed repeatedly, successive parameter values are displayed, and the appropriate parameter indicator LED becomes lit. The order of parameters when cycling through the parameter list is LIM 200, LIM 500, SAVE, RECALL, RANGE, then back to LIM 200, and so on.

To quickly cycle through the parameters, press and hold the (PARAMETER SETUP) SELECT switch and turn the ADJUST knob. This allows fast parameter cycling in either direction.

SET Switch

The **SET switch** is used to enter SET mode, where parameter values are stored into non-volatile memory.

If the **SET switch** is pressed while the LDP-3811 is in SELECT mode, the LDP-3811 will enter SET mode. While the SET switch is held in, the selected parameter value can be changed by turning the ADJUST knob. The new parameter value is stored in non-volatile memory when the SET switch is released.

LIM Parameters

The LIM parameters are used to set the absolute upper limit for laser drive current output. There are two limit settings, one for the 200 mA range, LIM 200, and another for the 500 mA range, LIM 500. The LIM value which is in effect depends on the RANGE selection. Only one LIM (and one RANGE) is in effect at any time. However, either LIM can be set while operating in either RANGE.

During operation, when the LIM current limit is reached, the LIM indicator will flash.

If the optional GPIB is implemented, the LIM current limit condition may be used to turn the laser drive current output off via the ENABLE:OUTOFF command.

The **LIM 200 indicator** becomes lit when the laser current limit for the 200 mA range is displayed.

The **LIM 500 indicator** becomes lit when the laser current limit for the 500 mA range is displayed.

The laser drive current limit (LIM) setting is independent of the voltage drop of the device connected to the laser drive current output, and therefore, no dummy load is required for precise adjustment of the current limit. The current limit can be adjusted safely, even while the OUTPUT is on.

SAVE and RECALL Parameter Functions

The SAVE and RECALL parameter functions are used to store and retrieve LDP-3811 parameter configurations for future use. For example, a specific test setup may be saved for later use, and then another setup may be used presently. Then, whenever the user desires to perform the specific test, its setup may be simply recalled. This saves setup time, and it reduces the chance of setup error for tests which are repeated periodically.

Refer to Figure 2.4 for the discussion of the SAVE and RECALL parameters.

Non-volatile memory is used for saving the instrument parameters. When a save operation is performed, all of the parameters which are currently in effect on the LDP-3811 are stored. The user selects a "bin" number (1 - 10) for saving the parameters. Then, when that "bin" number is recalled, the LDP-3811 parameters are reconfigured to the previously stored values.

To enter the SAVE/RECALL mode, first press the **(PARAMETER SETUP) SELECT switch** until the SAVE or RECALL parameter is selected, and the LDP-3811 displays the SAVE or RECALL "bin" number. To adjust the "bin" number, press the SET switch and turn the ADJUST knob. When the SET switch is released, the "save" or "recall" operation is performed, and then the LDP-3811 reverts to its former state.

The **SAVE indicator** becomes lit when the LDP-3811 is displaying a save bin number. The "bin" number is displayed as a number in the range 1 - 10. "Bin" 0 holds the reset (default) parameters.

The **RECALL indicator** becomes lit when the LDP-3811 is displaying a recall "bin" number. The "bin" number is displayed as a number in the range 0 - 10. "Bin" 0 is reserved for the reset (default) parameters.

RANGE Selection

The RANGE selection sets the laser diode current source output range, 200 mA or 500 mA. When a RANGE is selected, the appropriate current limit, LIM 200 or LIM 500, will be in effect.

The RANGE selection is made by pressing the **(PARAMETER SETUP) SELECT switch** until the **RANGE** parameter is selected. When the RANGE parameter is selected, the present RANGE indicator, 200 or 500, will flash. To change the RANGE, press the SET switch and turn the ADJUST knob until the desired range is shown on the digital display. When the SET switch is released, the range which was last selected on the display will be enabled, and the present setup will be stored in non-volatile memory.

During LDP-3811 operation, the enabled laser drive current output RANGE indicator is always lit.

Error Indicators

The LDP-3811 error indicators are shown in Figure 2.5. The functions of the most common LDP-3811 errors are shown in Table 2.2. The entire error code listing for the LDP-3811 is given in Appendix A.

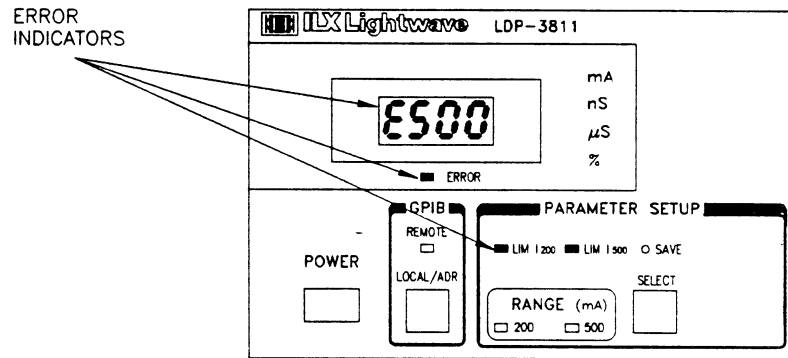

Figure 2.5 Error Indicators

Error Condition	Action
Interlock Open	OUTPUT off, ERROR light flashes, E501 message displayed for 3 seconds
KEYLOCK Disabled	OUTPUT off, ERROR light flashes, E522 message displayed for 3 seconds
Open Circuit / Voltage Limit	OUTPUT off, ERROR light flashes, E530 message displayed for 3 seconds
Current Limit	LIM 200 or LIM 500 light flashes

Table 2.2 Error Indicators

When an error condition occurs, the error light will stay lit until the error is corrected. In the case of a Voltage Limit / Open Circuit error, the error light will stay lit until the OUTPUT has been turned on and the error has been corrected. The error message will appear on the display for three seconds. If the OUTPUT is turned on and an error condition still exists, the error message will be displayed again for three seconds.

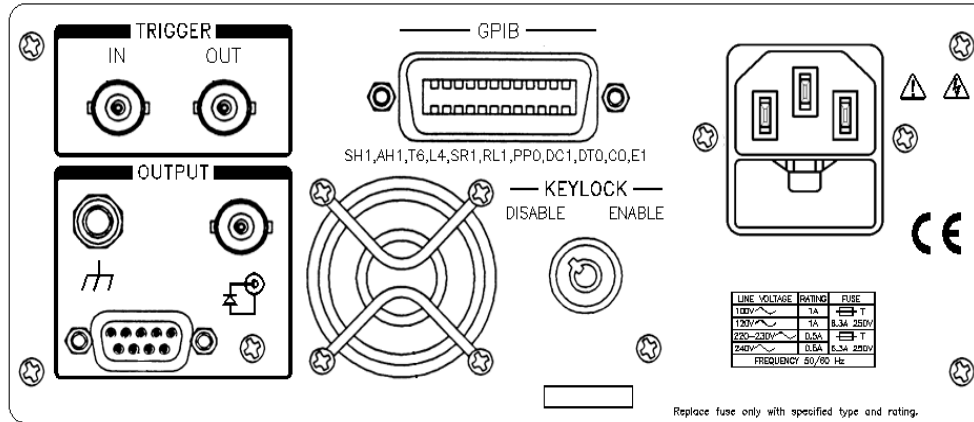

Figure 2.6 LDP-3811 Back Panel

Back Panel Controls and Connections

Refer to Figure 2.6 for the following discussions of back panel controls and connectors.

The OUTPUT Connectors

An auxiliary 9-pin D-sub connector is used for input and output connections, as shown by the pin-out diagram of Figure 2.7.

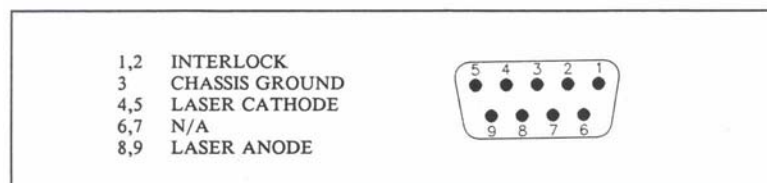

Figure 2.7 Back Panel 9-Pin OUTPUT Connector

Connecting to Your Laser

When connecting laser diodes and other sensitive devices to the LDP-3811, we recommend that the unit be powered-up and the OUTPUT be off. In this condition, a low impedance shunt is active across the output terminals. When disconnecting devices, it is only necessary to turn the OUTPUT off.

Pins 4 and 5 of the back panel OUTPUT connector are the negative output. Pins 8 and 9 are the positive output current connections (see Figure 2.7). These pins are jumpered to provide greater contact area for the output connections. This is done to reduce the risk of an open output connection due to a loose connector. Thus, the output is made safer for laser diodes.

Note: Whenever external connections are made to the output at pins 4 and 5, and 8 and 9, these connector leads **MUST** be jumpered as shown in Figure 2.7 to ensure the greatest laser diode safety.

Note: Pins 1 and 2 must be jumpered (interlock) in order to turn the laser drive current OUTPUT on.

We also recommend the use of the 9-pin D-sub connector, rather than the BNC connector, whenever possible. The 9-pin connector is safer to use, especially when operating in CW mode.

Laser Diode Connections and Shielding

Note: Before turning on the laser drive current OUTPUT, be sure that the current limit (LIM) has been correctly set.



WARNING

The cable connections to the laser must be secure enough that they won't open-circuit, should they be jostled or bumped. Should an open circuit occur during laser operation, the OUTPUT will be turned off (ON LED unlit) automatically.

Experience indicates that should an open circuit occur during laser operations (while the OUTPUT is ON), the laser may be damaged by a momentary circuit break-and-remake before the final circuit break. Therefore, secure cabling is very important.

It is recommended that the connections to the LDP-3811 OUTPUT be made using twisted wire pairs with an earth-grounded shield. The output terminals of the LDP-3811 are left floating relative to earth ground to suppress AC power-on/power-off transients that may occur through an earth-ground path. If the output circuit is earth-grounded at some point (such as through the laser package and mount), the user must be careful to avoid multiple earth grounds in the circuit. Multiple earth grounds may provide circuit paths that induce spurious currents in the OUTPUT leads.

TRIGGER Connectors

The (TRIGGER) OUT and IN connectors are BNC type. They are located just above the OUTPUT connectors on the back panel. The OUT trigger signal has the same pulse width and repetition interval as the OUTPUT signal, but at TTL level. This signal is available whenever the LDP-3811 is in one of the three Pulse modes of operation.

The IN trigger signal can be used to fire an OUTPUT pulse from the LDP-3811 when it is in EXT TRIG mode. The trigger signal should be at TTL level, and the LDP-3811 will be triggered on a rising edge (transition from low to high).

GPIB Connector

The GPIB connector is located at the top center of the back panel. The LDP-3811 GPIB connector meets IEEE-488.1 specifications. The interface specifications are listed in Table 4.2.

KEYLOCK Switch

The KEYLOCK switch is located at the lower center of the LDP-3811's back panel. This switch must be in the ENABLED position to operate the LDP-3811. Otherwise, the LDP-3811 OUTPUT will be disabled.

AC Power Entry Module and Fuse

The AC Power Entry Module and fuse are located at the right side of the LDP-3811's back panel below the power entry module. The LDP-3811 must be connected to a properly rated AC source in order to operate. The fuse should only be replaced with the same value fuse, as indicated on the LDP-3811's back panel.

Chassis Ground

For your convenience, a chassis ground post connector is located on the LDP-3811's back panel, next to the OUTPUT connectors.

General Operating Procedures

The following sections present some guidelines for operation, as well as some common operating procedures. Remote operations are discussed in Chapter 4.

Warm-up and Environmental Considerations

Operate the LDP-3811 at an ambient temperature in the range of 0 to +50 °C. Storage temperatures should be in the range of -40 to +70 °C. To achieve rated accuracy, let the LDP-3811 warm up for at least 1 hour before use.

Pulse Mode Operation

You can operate the LDP-3811 in several modes, Continuous Wave (CW), Constant Duty Cycle (CONST %), Constant Pulse Repetition Interval (CONST PRI), or External Trigger (EXT TRIG) mode.

For Constant Duty Cycle % mode, follow steps below. Instructions for the other Pulse operating modes are also included.

- a Plug the LDP-3811 into an AC power source supplying the correct voltage for your unit (refer to the back panel for the correct ratings).
- b Turn the back panel KEYLOCK switch to the ENABLE position. Turn on the LDP-3811 power by pressing the front panel POWER switch. To achieve rated accuracy, let the LDP-3811 warm up for at least 1 hour before use.

The OUTPUT stage will be off at power-up and the unit will automatically configure its parameters to the state which existed when the power was last shut off.

The laser drive current output range will be indicated by the corresponding LED in the RANGE section of the front panel.

- c Press the SELECT switch (in the PARAMETER SETUP section) and check the setting of LIM 200 or LIM 500 to insure that it is compatible with the laser (or other device) you are using. If you need to adjust the limit, press the SET switch and turn the ADJUST knob.

If the laser drive current output RANGE needs to be changed, press the SELECT switch until the present RANGE indicator starts to flash. Then, press the SET switch and turn the ADJUST knob to change the RANGE.

If a pre-configured setup is to be recalled, use the RECALL feature (see Section 2.4.6.4) and then recheck the parameter settings for confirmation.

- d Connect the laser (or other output device) to the back panel OUTPUT connector.

Press the I switch and check the set point (operating) current. If the set point requires changing, turn the ADJUST knob again until the desired value is displayed.

- e Select the mode, CONST % in this case, by pressing the MODE switch as needed.

- f Set the Pulse Width by pressing the PW switch and then turning the ADJUST knob. Then set the Duty Cycle Percent by pressing the DUTY CYCLE % / PRI switch and then turning the ADJUST knob.
- g Turn the OUTPUT on by pressing the ON switch. After a 2 second delay, the LDP-3811 will automatically drive the laser to the set point current.

While the OUTPUT is on, the laser drive current set point and limit may be changed. Also, the pulse width and/or duty cycle percentage may be edited. If the pulse width is changed, the duty cycle percentage may be automatically altered, if required (due to the limitations of the resolution of the PW and PRI values, see Section 2.4.4.4 for more information).

If the MODE of operation is changed, the OUTPUT will be forced off.

- h When the LDP-3811 is powered off, the state of the unit at power-down is saved in non-volatile memory.

For operation in Constant Pulse Repetition Interval (CONST PRI) mode, follow the above procedure, with the following changes.

- In Step e, select CONST PRI mode. In Step f, set the PRI (instead of the duty cycle) by pressing the DUTY CYCLE % / PRI switch and then turning the ADJUST knob.

For operation in External Trigger (EXT TRIG) mode, follow the above procedure, with the following changes.

- In Step d, also connect a TTL-level trigger source to the TRIGGER IN connector on the back panel of the LDP-3811. A positive-going TTL level signal will be used to initiate each output pulse from the LDP-3811.
- In Step e, select EXT TRIG mode. In Step f, adjust PW only. Duty cycle adjustment is disabled in EXT TRIG mode. Ignore Step i.

CW Mode Operation

This example is for Continuous Wave (CW) mode. The other operating modes follow similar procedures, and details of their operation are described in this chapter.

- a Plug the LDP-3811 into an AC power source supplying the correct voltage for your unit (refer to the back panel for the correct ratings).
- b Turn the back panel KEYLOCK switch to the ENABLE position. Turn on the LDP-3811 power by pressing the front panel POWER switch. To achieve rated accuracy, let the LDP-3811 warm up for at least 1 hour before use.

The OUTPUT stage will be off at power-up and the unit will automatically configure its parameters to the state which existed when the power was last shut off.

The laser drive current output range will be indicated by the corresponding LED in the RANGE section of the front panel.

- c Press the SELECT switch (in the PARAMETER SETUP section) and check the setting of LIM 200 or LIM 500 to insure that it is compatible with the laser (or other device) you are using. If you need to adjust the limit, press the SET switch and turn the ADJUST knob.

If the laser drive current output RANGE needs to be changed, press the SELECT switch until the present RANGE indicator starts to flash. Then, press the SET switch and turn the ADJUST knob to change the RANGE.

If a pre-configured setup is to be recalled, use the RECALL feature (see Section 2.4.6.4) and then recheck the parameter settings for confirmation.

- d Connect the laser (or other output device) to the back panel OUTPUT connector.

Press the I switch and check the set point (operating) current. If the set point requires changing, turn the ADJUST knob again until the desired value is displayed.

- e Select the CW mode. If the LDP-3811 is presently in a PULSE mode, press and hold in the (MODE) SELECT switch until the present mode LED indicator begins to flash. (This switch holding procedure is also used to return to Pulse mode from CW mode.)
- f Turn the OUTPUT on by pressing the ON switch. After a 2 second delay, the LDP-3811 will automatically drive the laser to the set point current.

While the OUTPUT is on, the laser drive current OUTPUT set point and Limit may be changed. The pulse width and/or duty cycle percentage can not be edited in CW mode (except via remote operation).

If the mode of operation is changed, the OUTPUT will be forced off.

- g When the LDP-3811 is powered off, the state of the unit at power-down is saved in non-volatile memory.

TRIGGER OUT Operation

The OUT trigger signal is available whenever the LDP-3811 is operated in a PULSE mode. The OUT trigger signal has the same pulse width as the OUTPUT signal, but at TTL level. To use the OUT trigger, connect the device which is to be triggered (from the LDP-3811) to the LDP-3811's back panel OUT (BNC) connector. Then operate the LDP-3811 in any PULSE mode.

COMMAND REFERENCE



This chapter is a guide to the syntax and usage of the various device-dependent commands for the 3811. It contains a reference section for all of the device-dependent commands, including those which may only be accessed via remote operation. Therefore, it is of primary interest to users who wish to utilize the GPIB option.

This chapter is divided into two parts. The first part contains an overview of the remote commands and syntax used by the 3811.

The second part contains all of the 3811 commands in alphabetical order. Figure 3.1 shows the format for the device command descriptions in this chapter. The commands which emulate local (front panel) operation are denoted by the solid box next to the Local label in the upper left corner of the command description. The error messages which may be displayed on the 3811 front panel are listed in Appendix A.

A short BASIC program example for remote operation of the 3811 is given in Section 3.6.

The common GPIB (ANSI/IEEE-488.2) commands which are supported by the 3811 are described in Chapter 4.

The following syntax terms are frequently used in this reference:

<white space> refers to ASCII characters (such as Space Bar) which are used as specific separators in the command syntax

<nrf value> refers to the IEEE-488.2 standard for numeric format notation. It is a generic label which means either integer, floating point, scientific notation number representation may be used.

For more information on terminology, see Chapter 4.

Overview of the 3811 Command Set

There are two types of device "commands", commands --which do not return anything, and queries --which return a stored value or state of the instrument. Queries must be terminated with a question mark (?), while commands may require a parameter(s) to follow.

"DIS 1"

For example, the "1" in the command "DIS 1", enables the 3811 display, while a "0" would disable (blank) the display. Table 3.1 (Section 3.2.1) contains the allowed substitute mnemonics for 1 and 0.

This command emulates the front panel operation of (1) selecting the display section, and (2) turning it on.

Most of the commands which emulate the front panel operation are just as intuitive (see Table 3.2). In Table 3.2 the required letters for each command are shown. Section 3.4 contains a detailed account of each command and tells which are also supported by front panel operations. In Section 3.4, each command is spelled out with the required letters in upper case and the optional letters in lower case. The optional letters may be used to improve program readability.

Substitute Parameter Names

For clarity in programming, the (Boolean) values of one and zero may also be represented by the appropriate substitute parameter names, as shown in Table 3.1.

Table 3.1 Substitute Parameter Names

ON	1
OFF	0
OLD	1
NEW	0
TRUE	1
FALSE	0

Compound Command Structure

Many of the 3811 remote commands require a compound structure. This is done to distinguish between different commands of the same type.

The compound command structure is similar to a directory path structure, as found in DOS. For example, commands which deal with the 3811's current limit

have the path "LIM:", as in the command to set the current limit for the 200 mA output range to 150.0 mA,

"LIM:I200 150"

This structure is illustrated in Figure 3.2. Table 3.2 lists all of the 3811's device-dependent commands, with the full path shown for each command and a brief explanation of its usage. For more information, see Section 3.4.

Section 3.4 presents a more detailed look at the 3811 device-dependent commands, including syntax diagrams, and example usage.

Table 3.2 LDP-3811 Device-Dependent Commands

NAME	PARAMETERS EXPECTED	FUNCTION
CAL:LDI	None	Used to initialize the laser drive current calibration cycle
CAL:LDI?	None	Returns the ready state for entering the laser drive current calibration value
CDC	1	Used to set the constant duty cycle percentage value
CDC?	None	Returns the actual duty cycle percentage
COND?	None	Returns the value of the condition register
DEC	None	Used with STEP command to decrement the laser drive current set point value by one step
DELAY	1	Used to create a delay in the execution of further commands
DIS	1	Turns the display on or off
DIS?	None	Returns the display message or value
DIS:CONST	None	Sets the display to show Duty Cycle % or PRI
DIS:CONST?	None	Returns on/off status of the Duty Cycle % / PRI switch
DIS:LDI	None	Sets the display to show laser drive current
DIS:LDI?	None	Returns on/off status of PW display switch
ENAB:COND	1	Sets the enable register for conditions
ENAB:COND?	None	Returns the value of the conditions enable register
ENAB:EVE	1	Sets the enable register for events
ENAB:EVE?	None	Returns the value of the event enable register
ENAB:OUTOFF	1	Sets the enable register for conditions/events which turn the OUTPUT off
ENAB:OUTOFF?	None	Returns the value of the Outoff enable register
ERR?	None	Returns errors generated since last query
EVE?	None	Returns the value of the event register

INC	None	Used with STEP command to increment the laser drive current set point value (see DEC command)
LDI	1	Used to set the laser drive current set point value
LDI?	None	Used to return the laser drive current measured value (measured about ever 200 mS)
LIM:I200	1	Used to set the laser drive current limit value for the 200 mA range
LIM:I200?	None	Used to return the laser drive current limit value for the 200 mA range
LIM:I500	1	Used to set the laser drive current limit value for the 500 mA range
LIM:I500?	None	Used to return the laser drive current limit value for the 500 mA range
MES	1	Used to enter a string of 16 ASCII bytes
MES?	None	Returns a previously stored ASCII message
MODE?	None	Returns the mode, CW (continuous wave), PRI (constant pulse repetition interval), DUTY (constant duty cycle %) or EXT (external trigger)
MODE:CDC	None	Sets the LDP-3811 to CDC (constant duty cycle) mode
MODE:CW	None	Sets the LDP-3811 to CW (continuous wave) mode
MODE:EXT	None	Sets the LDP-3811 to EXT (external trigger) mode
MODE:PRI	None	Sets the LDP-3811 to PRI (constant pulse repetition interval) mode
OUT	1	Same action as setting the OUTPUT switch on/off
OUT?	None	Returns the OUTPUT switch status
PRI	1	Sets and constant pulse repetition interval (PRI) value, in uSec
PRI?	None	Returns the present pulse repetition interval value, in uSec
PW	1	Sets the LDP-3811 pulse width, in uSec
PW?	None	Returns the LDP-3811 pulse width value, in uSec
RAD	1	Used to set the radix type for numerical data; decimal, binary and hexadecimal are allowed
RAD?	None	Used to return the radix type for numerical data; decimal, binary and hexadecimal are allowed
RAN	1	Used to set the laser drive current output range
RAN?	None	Returns the laser drive current range
SECURE	1	To be used by authorized service personnel only, to gain access to protected data
SET:CDC?	None	Returns the duty cycle percentage (CDC) set point
SET:LDI?	None	Returns the laser drive current set point, in mA

SET:PRI?	None	Returns the pulse repetition interval (PRI) set point, in uSec
STEP	1	Used to set the Step value for use with DEC or INC commands; defaults to a step of 1.00 (mA); Range is 0.01 - 99.99
STEP?	None	Returns the step value
TERM	1	Sets the program message terminator
TERM?	None	Returns the program message terminator
TIME?	None	Returns the elapsed time since the LDP-3811 was last powered up
TIMER?	None	Returns the elapsed time since the timer was last reset

Common Commands

Another type of command is the "common command". These commands are common to instruments which support the ANSI-IEEE-488.2 standard and are not necessarily reflected by front panel operations. Some of the common commands are useful for advanced programming techniques, such as generating service requests. However, common commands are not necessary for remote operation, and the beginning programmer may choose to ignore them entirely. The common commands for the 3811 are documented in Chapter 4.

Two common commands which are reflected by front panel operations are *SAV and *RCL. These commands remotely perform the same operations as when the SAVE and RECALL parameters are changed during Local (front panel) operation.

3811 Device-Dependent Commands

This section contains all of the device-dependent commands for the 3811, listed in alphabetical order. Sub-sections for each path are presented, listing the commands which are legal for that path. See Figure 3.2 for command path tree structure. All of the 3811's common commands and queries are listed in Section 4.3. The lower level remote interface messages are also listed in Chapter 4.

Command Path:Name.

Required letters are shown in upper case, lower case letters are optional.

Front Panel/Remote Execution.

A solid box means the command can be executed in that mode. Command mnemonics in front panel (local) mode may vary.

Command Description

Syntax Diagram

(For Remote Commands)

Parameters

Tells what parameters are expected, and their type.

An `<nrf value>` refers to a flexible numeric notation (IEEE-488.2). Integer, exponential or floating point may be used with the decimal radix. Alternate radices may be selected in remote operation.

Points of Interest. Has special information about the command.

Examples. Shows typical statements using the command.

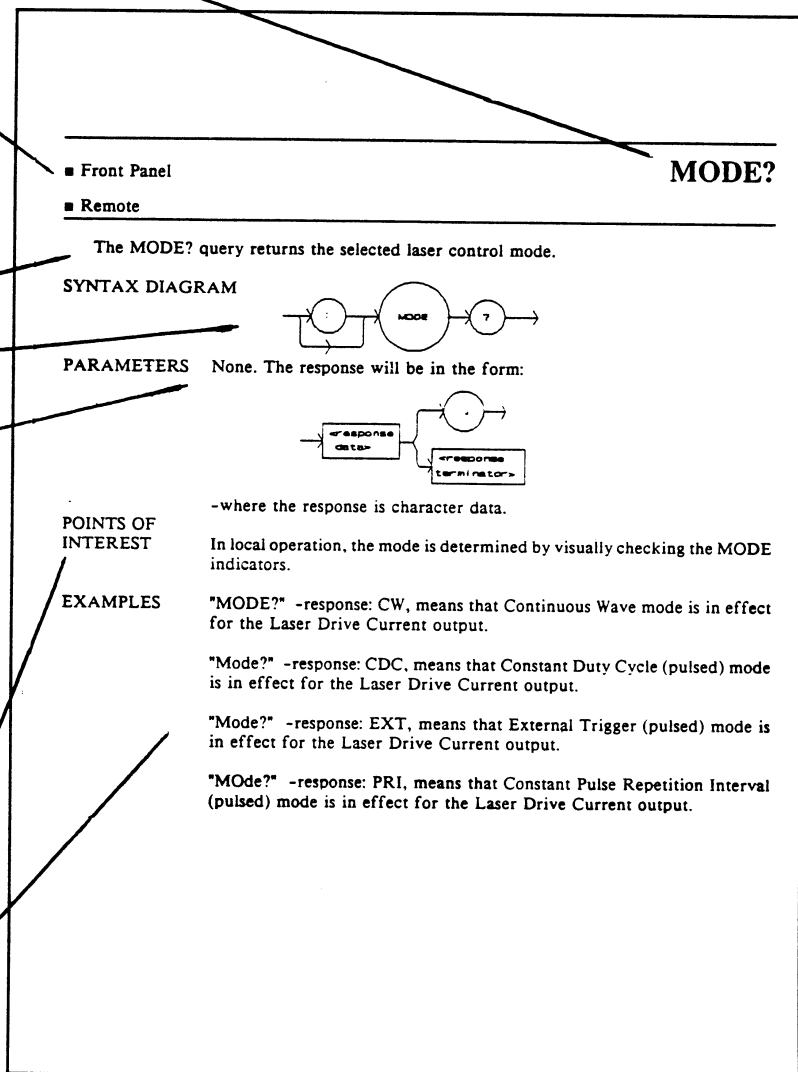

Figure 3.1 Command Description Format

Command Paths

The 3811 device-dependent commands are structured into tree format (see Figure 3.2). Each of the legal paths is listed below, followed by its list of path options, each of which is followed by the commands themselves.

It is recommended that the first-time user begin learning the commands by using the full path notation. Once the user is familiar with the commands, he or she may wish to take advantage of the shortcuts allowed for command paths.

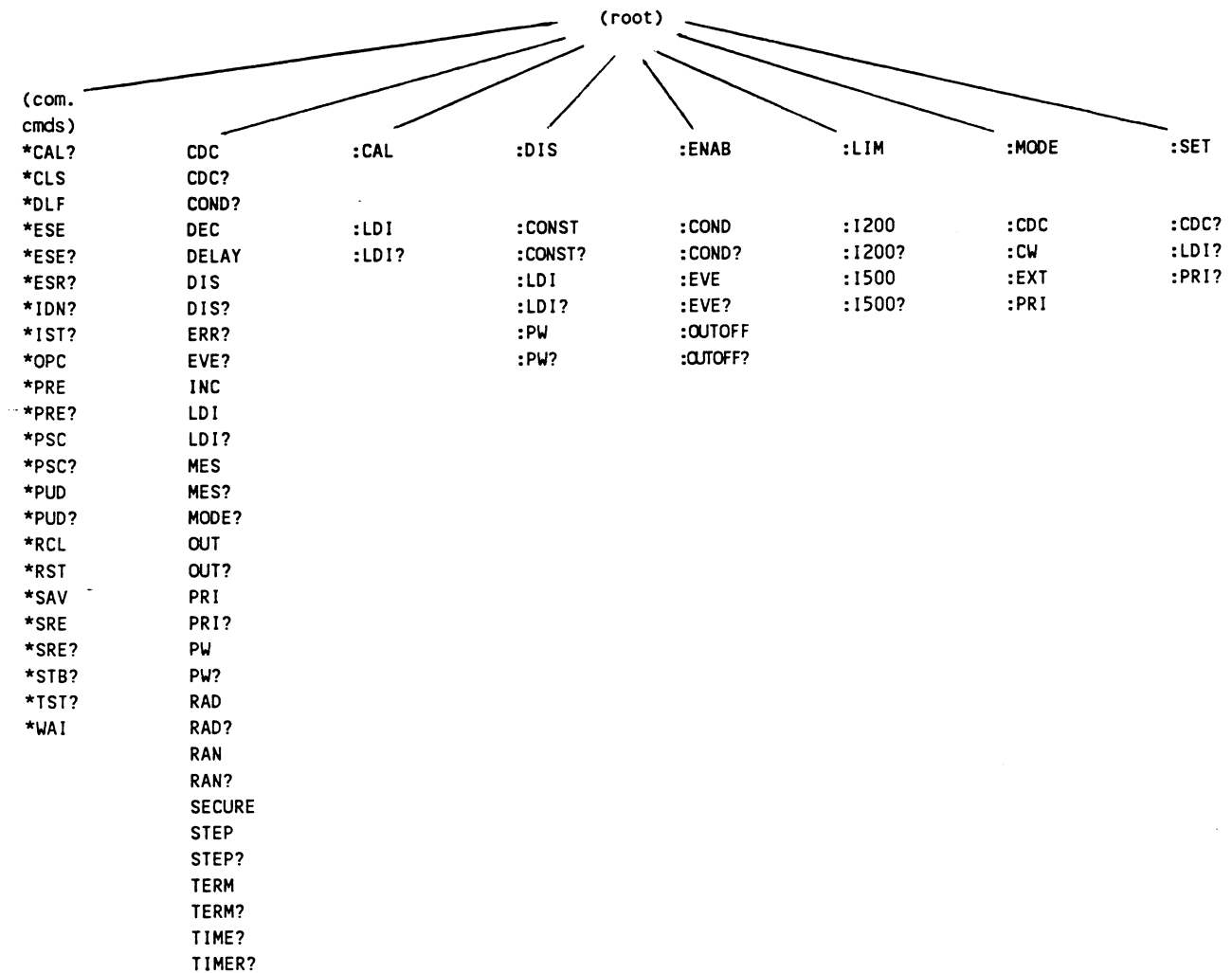

Figure 3.2 Command Path Structure

3811 Device-Command Reference

The following pages contain a reference for the device-dependent commands of the 3811. This reference contains useful information for both local and remote operation of the 3811.

References to the front panel labels are capitalized in the following reference pages (as is done throughout this manual). Therefore, a reference to the MODE section refers to the same-labeled switch area of the 3811.

In some references, parentheses are used to signify the labeled area for a particular switch or LED indicator on the front panel. For example, (MODE) SELECT refers to the switch labeled "SELECT" in the MODE section of the 3811 front panel.

The commands may include any combination of upper and lower case valid letters, as shown in the command examples in the following pages. For example, "LIm:i200 100", "lim:I200 100", and "LIM:i200 100" are all equivalent.

The required letters of a command are capitalized and the optional valid letters are in lower case in the headings of the command descriptions in the following pages. For example, the command heading "LIMit:I200" has the required letters, "LIM:I200", but allows the use of "LIMIT:I200" for clarity.

The following syntax terms are frequently used in this reference:

<white space> refers to ASCII characters (such as Space Bar) which are used as specific separators in the command syntax.

<nrf value> refers to the IEEE-488.2 standard for numeric format notation. It is a generic label which means either integer, floating point, scientific notation number representation may be used.

ANSI/IEEE-488.2 defined terms are indicated by the <> brackets. For more information on terminology, see Chapter 4.

CAL:

FRONT PANEL
REMOTE

The CAL: command path is used to get to the 3811's laser drive current calibration commands.
The following commands may be reached directly from the CAL: command path.

CAL:LDI
CAL:LDI?

Notes

The proper test equipment and test fixtures should be set up in order for these commands and queries to work.

CAL:LDI

FRONT PANEL
REMOTE

The CAL:LDI command is used to enter the laser drive current (set point, measurement, and limit) calibration mode.

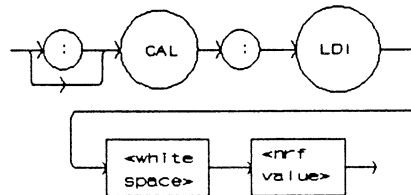

Parameters None.

Notes

After this command is issued, the 3811 will allow calibration of the current set point, measurement, and limit. This procedure is outlined in Chapter 5. The calibration defaults to the selected current range setting. Therefore, it is necessary to select the desired output current range (200 or 500 mA) before performing the calibration for that range.

In local operation, calibration mode is entered by simultaneously pressing the LOCAL/ADR and (MODE) SELECT switches.

The CAL:LDI? query may be used to determine if the 3811 is ready for the user to enter the correct value (in mA) via the LDI command.

Examples

"CAL:LDI" - action: the 3811 enters calibration mode for laser drive current
"CAL:Ldi" - action: the 3811 enters calibration mode for laser drive current

CAL:LDI?FRONT PANEL
REMOTE

The CAL:LDI? query is used to determine that the 3811 is ready for a value to be entered during the CAL:LDI calibration cycle for the laser drive current values.

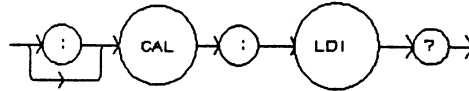

Parameters None. The response will be in the form:

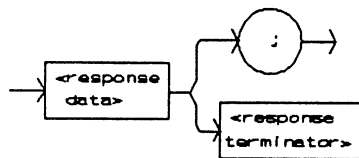

- where 1 = ready, 0 = not ready.

Notes After this query is issued and a response of 1 is received, the 3811 will be ready for the user to enter a value via the LDI command (see Chapter 5).

Examples "CAL:LDI?" - response: 1, means the 3811 is ready for the user to enter a value (in mA) via the LDI command.

"Cal:LDI?" - response: 0, means the 3811 is not yet ready for the user to enter a laser drive current value (because it is busy with internal operations which don't require user input, or an error has occurred).

CDC

FRONT PANEL
REMOTE

The CDC command is used to set the value of the Constant Duty Cycle, as a percentage, for use in constant duty cycle (CONST %) mode.

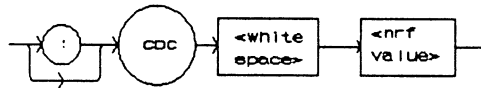

- Parameters** An `<nrf value>` which represents the constant duty cycle set point, as a percentage.
- Notes** This value may be set remotely only when in constant duty cycle mode (CONST %). In all other modes the value is ignored, but no error is generated. In local operation, this parameter can only be set while operating in constant duty cycle (CONST %) mode. CDC is related to PW and PRI as follows: $CDC = (PW/PRI) * 100$. The set CDC value is restricted to valid values based on the present PW (and the resolution of the PW and PRI parameters). In local operation, valid CDC values are calculated and displayed automatically when CDC is edited. However, in remote mode, if an invalid CDC value is entered, the 3811 will set the CDC to the closest valid CDC value and generate error #201. Therefore, in remote operation it is recommended that CDC set point values be compared to the desired value (via the SET:CDC? query), and that the error queue be checked periodically (via the ERR? query). The range of values of CDC is 0.01 - 100.00%.
- Examples** "CDC 40.0" - action: the constant duty cycle set point is set to 40.00%
"Cdc20; Set:cdc?" - returns: 20.5, means that although the constant duty cycle set point is initially set to 20.00%, 20.50% is the closest valid duty cycle (based on the present PW value).

CDC?

FRONT PANEL
REMOTE

The CDC? query returns the value of the actual duty cycle, as a percentage.

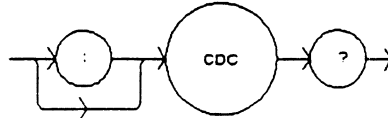

Parameters None. The response will be in the form:

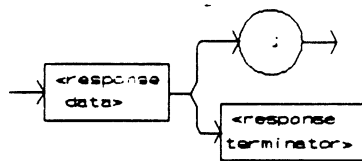

- where the response is an <nrf value>.

- Notes The response is in percent. The actual CDC value is not valid when in external trigger mode. The actual CDC value is usually different than the SET:CDC value, unless the 3811 is in constant CDC (CONST %) mode. In local operation, the CDC displayed is always the actual value. When CONST % mode is entered, if the set point CDC value is invalid for the present PW value, the set point CDC value is automatically changed to the closest value value (based on the present PW and the resolution of the PW and PRI parameters). The actual CDC value is then set to the set point CDC value.
- Examples "cdc?" - response: 90.6 means the actual duty cycle is 90.60%.

COND?

FRONT PANEL
REMOTE

The COND? query returns the value of the status condition register.

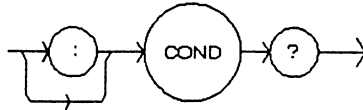

Parameters None. The response will be in the form:

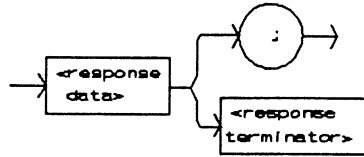

- where the response is the sum of the following:

1 - Laser Drive Current Limit	256 - N/A
2 - Voltage Limit / Open Circuit	512 - N/A
4 - N/A	1024 - Output On / Off State
8 - N/A	2048 - Ready for Calibration Data State
16 - Interlock Open	4096 - Calculation Error
32 - KEYLOCK Disabled	8192 - Hardware Error
64 - N/A	16384 - Software Error
128 - N/A	32768 - N/A

- Notes** The conditions which are reported to the status byte are set via the ENABLE:COND command.
The condition status may be constantly changing, while the event status is only cleared when the event status is read or the *CLS command is issued.
- Examples** "COND?" - response: 1025, means that the laser drive current limit and output on conditions currently exist.

DECFRONT PANEL
REMOTE

The DEC command decrements the selected laser control mode set point by one step.

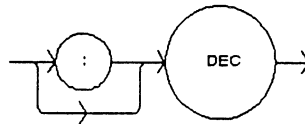

Parameters None.

Notes The decremental amount is one step. The step size can be edited via the STEP command; the default value is 0.01 mA.

Measurements are not automatically taken with each DEC step. Therefore, the user must issue a measurement query to update a measurement value.

The minimum time to complete one decrement is about 10 to 20 mSec.

Examples "STEP 30; DEC" - action: the laser drive current set point is decremented by 30.00 mA.

"STEP 3.3; DEC" - action: the laser drive current set point is decremented by 3.30 mA.

"Step 1.03; Dec; Dec" - action: the laser drive current set point is decremented twice by 1.03 mA, for a total decrease of 2.06 mA.

DELAYFRONT PANEL
REMOTE

The DELAY command is a sequential command which causes the execution of further commands to be delayed by a user-defined time.



Parameters An <nrf value> which represents the time delay, in milliseconds.

Notes The Operation-Complete flag is held false until the delay period elapses in between a series of commands.

This command is useful for creating delays based on the instrument clock, instead of having the host computer create a delay loop (which may be inefficient use of the host's CPU).

Examples "DELAY 500" - action: further commands and queries are not executed until 0.5 seconds have elapsed from the time this command is executed.

"Ldi 22; Delay 2000; Ldi?" - actions: the laser drive current is set to 22.00 mA, then the 3811 waits for 2.0 seconds before measuring and returning the measured output current.

DISplay

FRONT PANEL
REMOTE

The DISplay command enables or disables (turns off) the display and indicator LEDs.

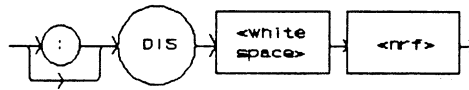

Parameters 1 = on; 0 = off.

Notes When the display is enabled, the value displayed will depend on the present mode of operation. When the display is disabled, it contains a blank message. When the display is disabled, all of the LEDs on the front panel will also be disabled. This command is useful when it is necessary to work in a dark environment.

Examples "DIS ON" - action: display is enabled.
"DISp 0" - action: display is disabled, blank.

DISplay?

FRONT PANEL
REMOTE

The DISplay? query returns the value shown on the display.

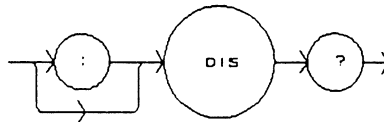

Parameters None. The response will be in the form:

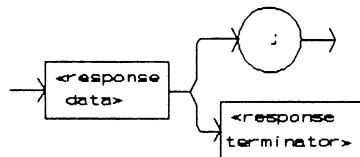

Notes - where the response data is a string.
Returns the actual string from the output buffer to the display. If the display is disabled, it returns " ".

In local operation, the display is queried by visually reading the display value.

Examples "DIS?" - response: "99.9" means the value on the display is 99.9.
"DISp?" - response " 0.6" means the value on the display is 0.6.
"DISp?" - response: "E501" means there is an E501 error message on the display (which means: interlock open -- output off).

DISplay:FRONT PANEL
REMOTE

The DISplay: command path is used to get to the 3811's display commands. The following commands may be reached directly from the DISplay: command path:

DISplay:CONST	DISplay:CONST?
DISplay:LDI	DISplay:LDI?
DISplay:PW	DISplay:PW?

DISplay:CONSTFRONT PANEL
REMOTE

The DISplay:CONST command activates the DUTY CYCLE % / PRI display and sets the front panel switch accordingly.

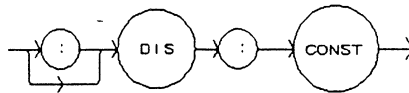

Parameters None.

Notes Effects the display only, not the laser drive current mode of operation. This command has no effect when the 3811 is in CW or EXT mode. In local operation, pressing the DUTY CYCLE % / PRI switch has the same effect as issuing this command remotely.

Examples "Mode:PRI; Display:Const" - action: sets the 3811 to constant PRI mode and activates the display to show the PRI set point value.
"Mode:CDC; Dis:CONST" - action: sets the 3811 to constant duty cycle mode and activates the display to show the duty cycle percentage set point value.

DISplay:CONST?

FRONT PANEL
REMOTE

The DISplay:CONST? query returns the status of the DUTY CYCLE % / PRI switch.

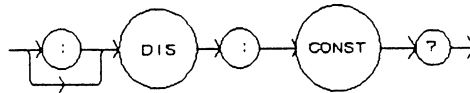

Parameters None. The response will be in the form:

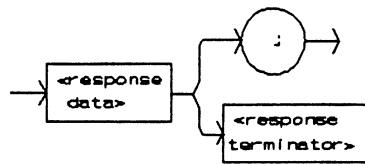

- where a response of 1 = on; 0 = off.

Notes The display will not show the duty cycle or PRI set point, even when the switch status is 1 (on), if the 3811 display is disabled.

In local operation, the status of the DUTY CYCLE % / PRI switch is determined by visually inspecting the LED (lit = on).

Examples "DIS:Const?" - response: 0, means the DUTY CYCLE % / PRI switch is not activated.

"Display:const?" - response: 1, means the DUTY CYCLE % / PRI switch is activated.

DISplay:LDI

FRONT PANEL
REMOTE

The DISplay:LDI command turns the I switch on.

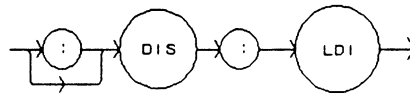

Parameters None.

Notes In local operation, the I display will show the laser drive current set point when the I switch is pressed or the ADJUST knob is turned. Otherwise, the measured laser drive current is displayed.

In local operation, the LDI display is activated by pressing the I switch.

Examples "DIS:LDI" - action: activates the I switch and sets the display to show laser drive current.

"Disp:Ldi" - action: activates the I switch and sets the display to show the laser drive current.

DISplay:LDI?FRONT PANEL
REMOTE

The DISplay:LDI? query returns the status of the I switch.

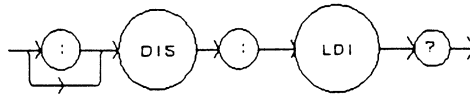

Parameters None. The response will be in the form:

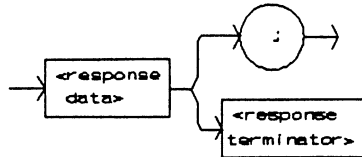

- where a response of 1 = on; 0 = off.

Notes The display will not show the laser drive current, even when the switch status is 1 (on), if the 3811 display is disabled.

In local operation, the status of the I switch is determined by visually inspecting the I switch LED (lit = on).

Examples “DIS:LDI?” - response: 1, means the I switch is activated.
“display:ldi?” - response: 0, means the I switch is not activated.

DISplay:PWFRONT PANEL
REMOTE

The DISplay:PW command activates the pulse width display and sets the front panel switch accordingly.

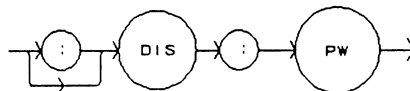

Parameters None.

Notes Effects the display only, not the laser drive current mode of operation. This command has no effect when the 3811 is in CW mode.

In local operation, pressing the PW switch has the same effect as issuing this command remotely.

Examples “Mode:PRI; Display:Pw” - action: sets the 3811 to constant PRI mode and activates the display to show the pulse width (PW) value.
“Mode:CW; Dis:PW” - action: sets the 3811 to continuous wave mode, but the display changes to show LDI (not PW) because the pulse width value is not used in CW mode.

DISplay:PW?

FRONT PANEL
REMOTE

The DISplay:PW? query returns the status of the PW switch.

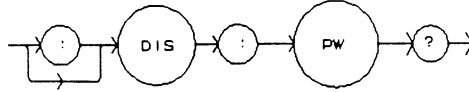

Parameters None. The response will be in the form:

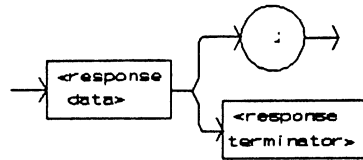

- where a response of 1 = on; 0 = off

Notes The display will not show the pulse width, even when the switch status is 1 (on), if the 3811 display is disabled.

In local operation, the status of the PW switch is determined by visually inspecting the LED (lit = on).

Examples "DIS:PW?" - response: 0, means the PW switch is not activated.
"Display:PW?" - response: 1, means the PW switch is activated.

ENABLE:

FRONT PANEL
REMOTE

The ENABLE: command path is used to get to the 3811's status enable commands. The following commands may be reached directly from the ENABLE: command path:

ENABLE:COND	ENABLE:COND?
ENABLE:EVENT	ENABLE:EVENT?
ENABLE:OUTOFF	ENABLE:OUTOFF?

ENABLE:CONDFRONT PANEL
REMOTE

The ENABLE:COND command sets the condition status enable register of the operations for summary (in bit 3 of the status byte) and generation of service requests.

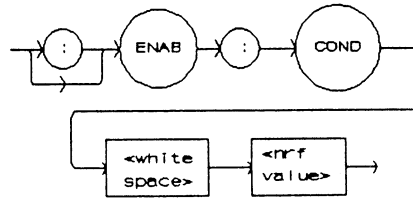

Parameters An <nrf value> whose sum represents the enabled bits:

1 - Laser Drive Current Limit	256 - N/A
2 - Voltage Limit / Open Circuit	512 - N/A
4 - N/A	1024 - Output On / Off State
8 - N/A	2048 - Ready for Calibration Data State
16 - Interlock Open	4096 - Calculation Error
32 - KEYLOCK Disabled	8192 - Hardware Error
64 - N/A	16384 - Software Error
128 - N/A	32768 - N/A

Notes The enabled or disabled conditions can be read by using the ENABLE:COND? query. The condition status can be monitored by the COND? query. If any of the enabled conditions are true, bit 3 of the status byte register will be set. The enable registers normally retain their values at power up (as they were at the last power down) unless the power on status clear flag is set true (see *PSC, Chapter 4).

Examples "ENAB:COND 129" - action: enables the status condition register so that the Voltage Limit/Open Circuit and Laser Drive Current Limit conditions will be summarized in the status byte (bit 3).
"Enable:Cond #H7C33" - action: enables the status condition register so that any and all of the above conditions will be reported in the status byte register (bit 3).

ENABLE:COND?

FRONT PANEL
REMOTE

The ENABLE:COND? query returns the value of the status condition enable register.

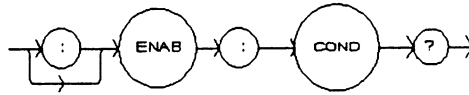

Parameters None. The response will be in the form:

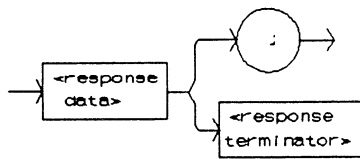

- where the response is the sum of the following:

1 - Laser Drive Current Limit	256 - N/A
2 - Voltage Limit / Open Circuit	512 - N/A
4 - N/A	1024 - Output On / Off State
8 - N/A	2048 - Ready for Calibration Data State
16 - Interlock Open	4096 - Calculation Error
32 - KEYLOCK Disabled	8192 - Hardware Error
64 - N/A	16384 - Software Error
128 - N/A	32768 - N/A

Notes The enabled conditions can be set by using the ENABLE:COND command. The condition status can be monitored by the COND? query.

Examples “ENAB:COND?” - response: 18, means that the Voltage Limit/Open Circuit and Interlock Open conditions will be reported (in summarized form) to the status byte (bit 3).

“Radix Hex; Enable:Cond?” - response: #H2001, means that the laser drive current limit and hardware error conditions will be reported (in summarized form) to the status type (bit 3).

ENABLE:EVENT

FRONT PANEL

REMOTE

The ENABLE:EVENT command sets the status event enable register of the LAS operations. These events are summarized in bit 2 of the status byte register.

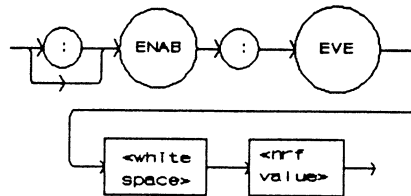

Parameters An <nrf value> whose sum represents the bits which are enabled:

1 - Laser Drive Current Limit	256 - N/A
2 - Voltage Limit / Open Circuit	512 - N/A
4 - N/A	1024 - Output On / Off State Changed
8 - N/A	2048 - Operational for Measure Queries
16 - Interlock State Changed	4096 - Calculation Error
32 - KEYLOCK State Changed	8192 - Hardware Error
64 - N/A	16384 - Software Error
128 - N/A	32768 - N/A

Notes The enabled events can be read by using the ENABLE:EVENT? query. The event status can be monitored by the EVENT? query.

The enable registers normally retain their values at power up (as they were at the last power down) unless the power on status clear flag is set true (see *PSC, Chapter 4).

Examples “ENAB:EVENT 17” - action: enables the status Event register so that the laser drive current limit and interlock state changed events will be reported (in summarized form) to the status byte (bit 2).

“Enable:Event #H7C33” - action: enables the status Event register so all of the above events will be reported (in summarized form) to the status byte (bit 2).

ENABLE:EVENT?

FRONT PANEL
REMOTE

The ENABLE:EVENT? query returns the value of the status Event register.

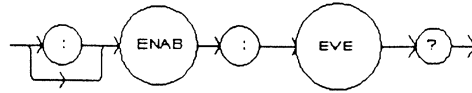

Parameters None. The response will be in the form:

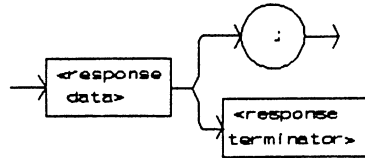

- where the response is the sum of the following:

1 - Laser Drive Current Limit	256 - N/A
2 - Voltage Limit / Open Circuit	512 - N/A
4 - N/A	1024 - Output On / Off State Changed
8 - N/A	2048 - Operational for Measure Queries
16 - Interlock State Changed	4096 - Calculation Error
32 - KEYLOCK State Changed	8192 - Hardware Error
64 - N/A	16384 - Software Error
128 - N/A	32768 - N/A

Notes The enabled events can be set by using the ENABLE:EVENT command. The event status can be monitored by the EVENT? query.

Examples "ENAB:EVE?" - response: 1040, means that the output on/off state change and interlock state changed events will be reported (in summarized form) to the status byte register (bit 2).

"Radix Hex; Enab:Eve?" - response: #H7C33, means that all of the above events will be reported (in summarized form) to the status byte register (bit 2).

ENABLE:OUTOFF

FRONT PANEL
REMOTE

The ENABLE:OUTOFF command sets the status outoff enable register for the operations (things which will turn the laser drive current output off).

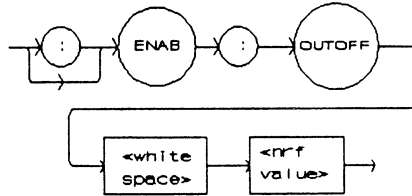

- Parameters An <nrf value> whose sum represents the enabled bits:
1 - Laser Drive Current Limit (all other bits are N/A)
- Notes The enabled outoff bits can be read by using the ENABLE:OUTOFF? query. The factory default value for this register is 0.
- Examples "ENAB:OUTOFF 1" - action: enables the status outoff register so that the laser drive current limit condition will cause the laser drive current output to be turned off.

ENABLE:OUTOFF?

FRONT PANEL
REMOTE

The ENABLE:OUTOFF? query returns the value of the status outoff enable register.

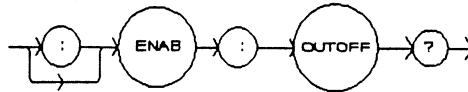

- Parameters None. The response will be in the form:

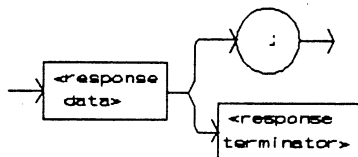

- where the response is the sum of the following:
1 - Laser Drive Current Limit (all other bits are N/A)
- Notes The enabled events or conditions which are used to turn the laser drive current output off can be set by using the ENABLE:OUTOFF command. The laser drive current output status can be monitored by the OUT? or COND? query.
- Examples "ENAB:OUTOFF?" - response: 0, means that the laser drive current limit condition will not cause the laser drive current output to be turned off.
"ENAB:OUTOFF?" - response: 1, means that the laser drive current limit condition will cause the laser drive current output to be turned off.

ERRors?

FRONT PANEL

REMOTE

The ERRors? query returns a list of command, execution, and device errors which have occurred since the last ERRors query. These errors are indicated by a number which corresponds to the type of error which occurred. See Appendix A for error code information.

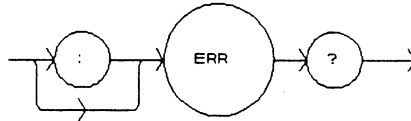

Parameters None. The response will be in the form:

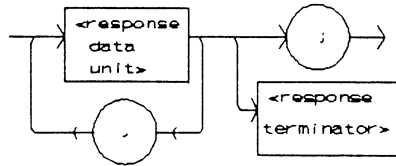

- where each <response data unit> consists of an error code value.

Notes The response data will be a list of the current errors. The errors are represented by numbers and are separated by commas. A response of 0 indicates that no errors were reported. The response data is sent as character data.

Examples “ERR?” - response: 0, means no errors reported.
“Errors?” - response: 201, means that the <PROGRAM DATA> (command parameter) value out of range error was reported since the last ERRors? query.

EVEnt?FRONT PANEL
REMOTE

The EVEnt? query returns the value of the status event register.

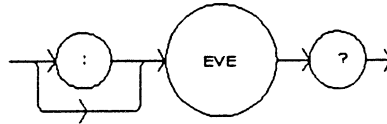

Parameters None. The response will be in the form:

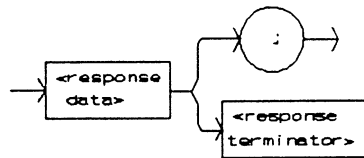

- where the response is the sum of the following:

1 - Laser Drive Current Limit	256 - N/A
2 - Voltage Limit / Open Circuit	512 - N/A
4 - N/A	1024 - Output On / Off State Changed
8 - N/A	2048 - Operational for Measure Queries
16 - Interlock State Changed	4096 - Calculation Error
32 - KEYLOCK State Changed	8192 - Hardware Error
64 - N/A	16384 - Software Error
128 - N/A	32768 - N/A

Notes The events which are summarized in bit 2 of the status byte can be set by using the ENABLE:EVEnt command.

Any bits set in the event status are cleared when the event status is read or when the *CLS command is issued, whereas the condition status bits reflect the continually updated state and are not effected by any query.

Examples "EVE?" - response: 1025, means that the output on/off state changed and laser drive current limit events occurred since the last EVE? query.

"Radix Hex; Laser:Event?" - response: #H22, means that the KEYLOCK state changed and voltage limit/open circuit event has occurred since the last EVEnt? query.

INC

FRONT PANEL
REMOTE

The INC command increments the laser diode current set point by one step.

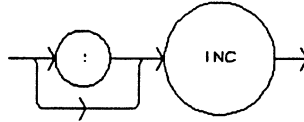

Parameters None.

Notes The step size can be edited via the STEP command, its default value is 0.01 mA. Measurements are not automatically taken with each INC step. Therefore, the user must issue a measurement query to update a measurement value. The minimum time to complete one increment is about 10 to 20 mSec.

Examples “STEP 30; INC” - action: the current set point is incremented by 30.00 mA.
 “STEP 3.33; INC” - action: the current set point is incremented by 3.33 mA.
 “Step 3; Inc;Inc;Inc” - action: the current set point is incremented by 3.00 mA, three times. The laser drive current output is incremented a total of 9.00 mA.

LDI

FRONT PANEL
REMOTE

The LDI command sets the laser drive current set point.

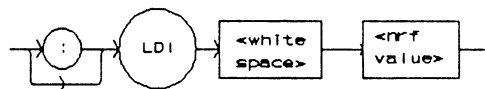

Parameters An <nrf value> which represents the laser drive current, in mA.

Notes Set pint is the same for both low and high laser drive current ranges. If the 3811 is in CAL:LDI calibration mode, this command is used to enter the measured laser diode current (in mA) to calibrate the laser diode current measurement. In remote mode, the resolution is 0.01 mA.

Examples “LDI 40” - action: sets the laser drive current to 40.00 mA.
 “ldi 100.0” - action: sets the laser drive current to 100.00 mA.

LDI?

FRONT PANEL
REMOTE

The LDI? query returns the value of the measured laser drive current.

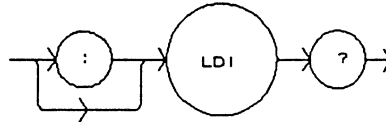

Parameters None. The response will be in the form:

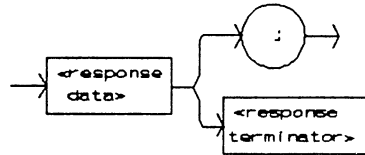

- where the response is an <nrf value>.

Notes Response is the measured laser drive current output current, for either low or high laser drive current ranges. In remote mode, the resolution is 0.01 mA.

Examples "ldi?" - response: 30.0, means the measured laser drive current is 30.00 mA.

LIMit:

FRONT PANEL
REMOTE

The LIMit: command path is used to get to the 3811's limit commands and queries.

The following commands and queries may be reached directly from the LIMit: command path.

LIMit:I200	LIMit:I200?
LIMit:I500	LIMit:I500?

LIMit:I200

FRONT PANEL
REMOTE

The LIMit:I200 command sets the laser drive current limit value for the 200 mA range.

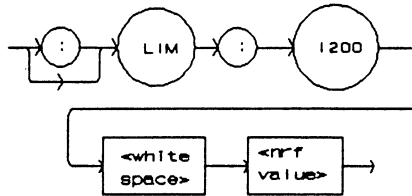

Parameters An <nrf value> which represents the 200 mA range limit current, in mA.

Notes The laser drive current limit is in effect in all modes of operation of the laser output, while in the 200 mA range.

The LIM I200 limit may be edited while operating the 3811 in either output range.

Examples "LIM:I200 50" - action: the laser drive current limit, for the 200 mA output range, is set to 50.0 mA.

":Limit:I200 60" - action: the laser drive current limit, for the 200 mA range, is set to 60.0 mA.

LIMit:I200?

FRONT PANEL
REMOTE

The LIMit:I200? query returns the value of the laser drive current limit for the 200 mA range.

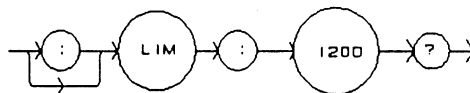

Parameters None. The response will be in the form:

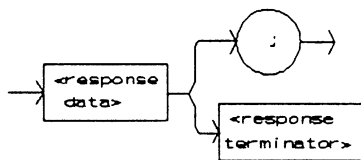

- where the response is an <nrf value>.

Notes The current limit is valid for all modes of laser operation, while in the 200 mA range.

Examples "LIM:I200?" - response: 40.0, means the current limit is 40.0 mA.

"lim:I200?" - response: 50.0, means the current limit is 50.0 mA.

LIMit:I500FRONT PANEL
REMOTE

The LIMit:I500 command sets the laser drive current limit value for the 500 mA range.

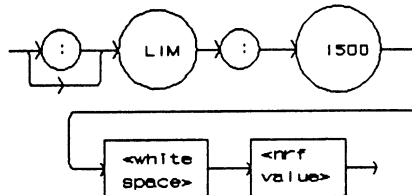

Parameters An <nrf value> which represents the 500 mA range limit current, in mA.

Notes The laser drive current limit is in effect in all modes of operation of the laser output, while in the 500 mA range.

The LIM I500 limit may be edited while operating the 3811 in either output range.

Examples "LIM:I500 50" - action: the laser drive current limit, for the 500 mA output range, is set to 50.0 mA.

":Limit:I500 400" - action: the laser drive current limit, for the 500 mA range, is set to 400.0 mA.

LIMit:I500?FRONT PANEL
REMOTE

The LIMit:I500? query returns the value of the laser drive current limit for the 500 mA range.

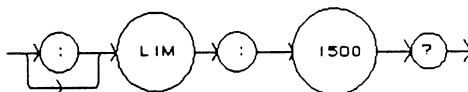

Parameters None. The response will be in the form:

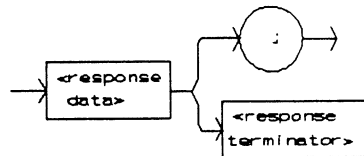

- where the response is an <nrf value>.

Notes The current limit is valid for all modes of laser operation, while in the 500 mA range.

Examples "LIM:I500?" - response: 40.0, means the current limit is 40.0 mA.

"lim:I500?" - response: 500.0, means the current limit is 500.0 mA.

MESSage

FRONT PANEL
REMOTE

The MESsage command allows the user to enter an ASCII string of up to 16 non-zero characters. This command may be useful for storing messages which relate to a test or configuration.

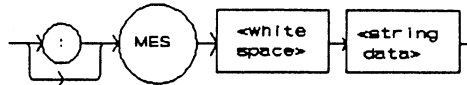

Parameters An ASCII string which is 1 - 16 bytes in length.

Notes The message may contain any ASCII character, but will be terminated when a NULL terminator character is received. If the message has less than 16 bytes, the software will fill the remaining message space with the space character. After 16 bytes have been entered, the software will null-terminate the string.

Examples MESSAGE "This is a test." - action: the string, "This is a test." will be stored in non-volatile memory.

Mes "Test 3" - action: the string, "Test 3" will be stored in non-volatile memory.

MESSage?

FRONT PANEL
REMOTE

The MESsage? query returns the previously stored message. This message will always be 16 bytes long and enclosed in quotes. The message is entered via the MESsage command.

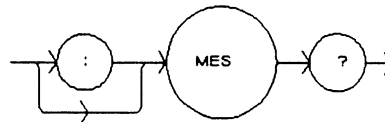

Parameters None. The response will be in the form:

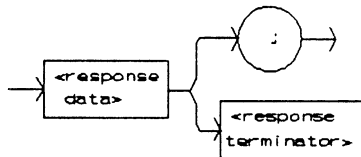

- where the <response data> is a 16-byte long string.

Notes The response data will be a 16-byte long string. If there is no previously stored message, the response will be " ", all spaces.

Examples "MES?" - response: "Test 3 ", means the previously stored message was "Test 3".

"Message?" - response: "This is a test.", means the previously stored message was "This is a test."

MODE?FRONT PANEL
REMOTE

The MODE? query returns the selected laser control mode.

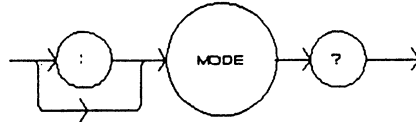

Parameters None. The response will be in the form:

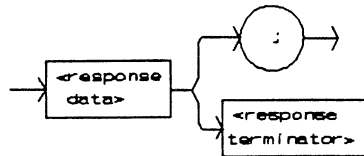

- where the response is character data.

Notes In local operation, the mode is determined by visually checking the MODE indicators.

Examples "MODE?" - response: CW, means that continuous wave mode is in effect for the laser drive current output.
 "Mode?" - response: CDC, means that (CONST %) constant duty cycle (pulsed) mode is in effect for the laser drive current output.
 "MOde?" - response: EXT, means that external trigger (pulsed) mode is in effect for the laser drive current output.
 "MOde?" - response: PRI, means that (CONST PRI) constant pulse repetition interval (pulsed) mode is in effect for the laser drive current output.

MODE :FRONT PANEL
REMOTE

The MODE: command path is used to get to the 3811's laser mode selection commands.

The following commands may be reached directly from the MODE: command path.

MODE:CDC	MODE:CW
MODE:EXT	MODE:PRI

MODE : CDC

FRONT PANEL
REMOTE

The MODE:CDC command selects laser (CONST %) constant duty cycle (pulsed) mode.

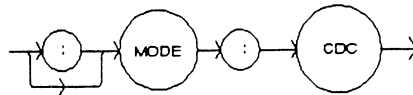

Parameters None.

Notes This command has the same effect as selecting CONST % mode on the 3811 front panel.

In this mode, when the pulse width (PW) is edited, the pulse repetition interval is automatically adjusted to match the desired duty cycle percentage. However, if the pulse width is such that the desired duty cycle cannot be achieved (due to the resolution of the pulse on/off times) the duty cycle set point will be changed automatically.

Examples “mode:cdc” - action: enables the laser constant duty cycle (pulsed) mode.
“Mode:CDC” - action: enables the laser constant duty cycle (pulsed) mode.

MODE : CW

FRONT PANEL
REMOTE

The MODE:CW command selects continuous wave mode.

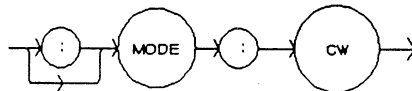

Parameters None.

Notes This command has the same effect as selecting CW mode on the 3811 front panel. In this mode, the pulse circuit is turned off.

Examples “mode:cw” - action: enables the (CW) continuous wave (for laser drive current) mode.

MODE:EXTFRONT PANEL
REMOTE

The MODE:EXT command selects external trigger (pulsed) mode.

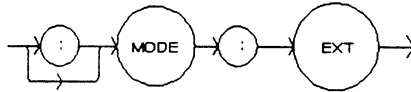

Parameters None.

Notes This command has the same effect as selecting EXT TRIG mode on the 3811 front panel. In this mode, the laser drive current output pulse is fired whenever a TTL level input signal is received via the TRIGGER IN (BNC) connector on the 3811 back panel.

Examples “mode:ext” - action: enables the external trigger (pulsed) mode.
“Mode:EXT” - action: enables the external trigger (pulsed) mode.

MODE:PRIFRONT PANEL
REMOTE

The MODE:PRI command selects constant pulse repetition interval mode.

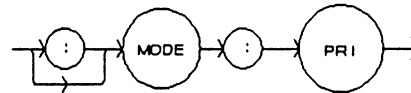

Parameters None.

Notes This command has the same effect as selecting CONST PRI mode on the 3811 front panel.

In this mode, the laser drive current pulse repetition interval is constant. However, the PRI value cannot be set less than the PW value.

Examples “MODE:PRI” - action: sets the laser drive current output for constant pulse repetition interval (pulsed) mode.

OUTput

FRONT PANEL
REMOTE

The OUTput command turns the laser drive current OUTPUT on or off.

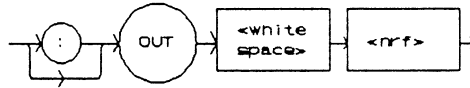

Parameters An <nrf value>; 1 = on, 0 = off.

Notes After the OUTPUT is turned on, it is useful to wait until the output is stable before performing further operations (see the DELAY command). The two second delay and slow-start circuit in the 3811 requires about 2.5 seconds before the OUTPUT settles (within specification) to a non-zero set point value. When the laser drive current output is off, it is safe to connect or disconnect devices to the OUTPUT terminals.

Examples "LDI 20; OUT ON" - action: sets the laser drive current to 20.0 mA and then turns the OUTPUT on.
"Out 0" - action: turns the laser drive current OUTPUT off.

OUTput?

FRONT PANEL
REMOTE

The OUTput? query returns the status of the laser drive current output.

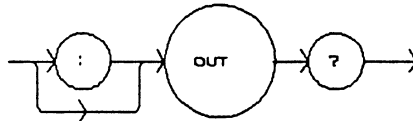

Parameters None. The response will be in the form:

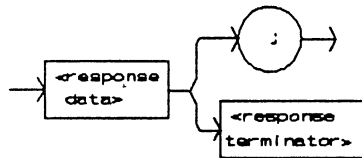

- where the response is an <nrf value>.

Notes The OUTput? query has the same effect as visually checking the front panel OUTPUT ON indicator. The OUTPUT current may not be activated, even though the response is 1, due to the two second OUTPUT on delay.

Examples "OUT?" - response: 0, means that the current output is "off".
"OUT?" - response: 1, means that the current output switch is "on".

PRI

FRONT PANEL
REMOTE

The PRI command is used to set the value of the pulse repetition interval, in uSec, for use in constant PRI mode.

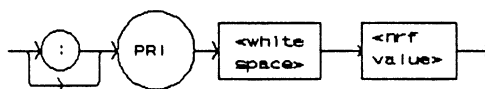

Parameters An <nrf value> which represents the pulse repetition interval, in uSec.

Notes This value may be set remotely only while in constant PRI mode. In all other modes the value is ignored, but no error is generated. In local operation, this parameter can only be set while operating in constant PRI mode.

The set PRI value is limited to be greater or equal to the present PW value. If a value for PRI is entered which is less than the present PW value, it will be automatically adjusted to equal PW.

The range of values on PRI is 1.0 - 6500.0 uSec.

Examples "PRI 400" - action: the PRI is set to 400.0 uSec.
"PW 200; PRI 100" - action: the pulse width is set to 200.0 uSec, then the PRI is set to 200.0 uSec (since it cannot be less than PW).

PRI?

FRONT PANEL
REMOTE

The PRI? query returns the value of the actual pulse repetition interval, in uSec.

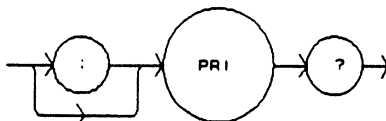

Parameters None. The response will be in the form:

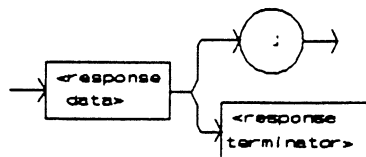

- where the response is an <nrf value>.

Notes The response is in uSec. The actual PRI value is not valid when in external trigger mode. The actual PRI value is usually different than the SET:PRI value, unless the 3811 is in constant PRI mode.

Examples "pri?" - response: 90.6 means the actual pulse repetitio interval is 90.6 uSec.
"PRI?" - response: 120.2 means the actual pulse repetition interval is 120.2 uSec.

PW

FRONT PANEL
REMOTE

The PW command is used to set the value of the pulse width in uSec, for use in all pulsed modes.

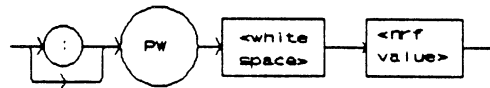

Parameters An <nrf value> which represents the pulse width, in uSec.

Notes In local operation, this parameter can not be set while operating in CW mode. The PW value is limited to be less than or equal to the present PRI value. If a value of PW is entered which is greater than the present PRI value, it will be automatically adjusted to equal PRI.

PW?

FRONT PANEL
REMOTE

The PW? query returns the value of the pulse width, in uSec.

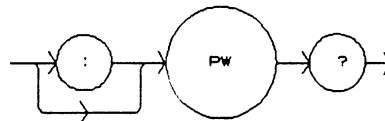

Parameters None. The response will be in the form:

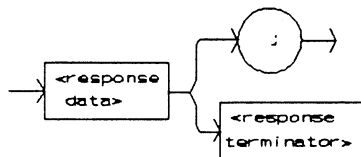

- where the response is an <nrf value>.

Notes The response is in uSec. The pulse width is limited to be less than or equal to the present (actual) PRI value.

Examples "pw?" - response: 90.6 means the pulse width is 90.6 uSec.
"PW?" - response: 1200.9 means the pulse width is 1200.9 uSec.

RADixFRONT PANEL
REMOTE

The RADix command allows the programmer to select the radix type for status, condition, and event query response data. Decimal, binary, hexadecimal, and octal are allowed.

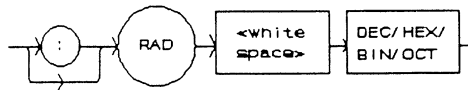

- Parameters** Character program data is expected, as shown above.
- Notes** DECimal is the default type. Only the first three letters of the words decimal, hexadecimal, binary, or octal are required. When the RADIX is selected, all status, condition, and event queries will return values in the new radix. In the cases where the radix is not DECimal, the flexible numeric type <nrf value> (as shown in the command reference diagrams) will be replaced by HEX, BIN, or OCT representation. All of the above radices may be used to enter program data at any time, without the need for issuing the RADix command. The proper prefix must also be used with hex (#H), binary (#B), or octal (#O). This command may be useful for setting up status reporting blocks. The bit-wise status representation may be more easily read in BIN or HEX.
- Examples** "RAD dec" - action: the decimal radix is selected.
 "rad hex; *ESR?" - action: the hexadecimal radix is selected; - response: #H80, means power on was detected.
 "RADIX BIN" - action: the binary radix is selected.
 "rad octal" - action: the octal radix is selected.

RADix?

FRONT PANEL
REMOTE

The RADix? query allows the programmer to determine which radix type for status, condition, and event query response data is currently selected. Decimal, binary, octal, and hexadecimal are allowed.

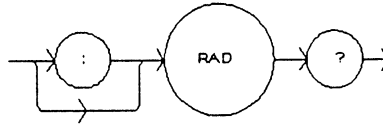

Parameters None. The response will be in the form:

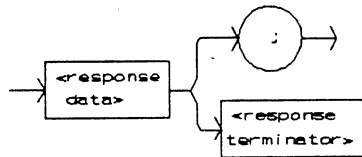

- where the character response data of DEC means decimal, BIN means binary, HEX means hexadecimal, and OCT means octal.

Notes DEC is the default type. The 3811 defaults to this radix at power up. The RADix command is used to select the desired radix. Once it is changed, the new radix will remain in effect until the power is shut off or a new RADix command is issued.

Examples "RAD?" - response: Dec, means the selected radix is decimal.
"rad?" - response: Hex, means the selected radix is hexadecimal.
"RADIX?" - response: Oct, means the selected radix is octal.

RANge

FRONT PANEL
REMOTE

The RANge command selects the laser's drive current output range.



Parameters An <nrf value>; 200 = 200 mA, 500 = 500 mA range.

Notes This range setting effects the laser drive current output range only. The laser drive current output should be "off" when this command is issued. If the laser drive current output is "on" when this command is parsed, the 3811 will generate error #515, and the range will not be changed.

Examples "RAN 200" - action: sets the laser drive current range to 200 mA.
"Laser:Range 500" - action: sets the laser drive current range to 500 mA.

RANge?FRONT PANEL
REMOTE

The RANge? query returns the value of the laser drive current range.

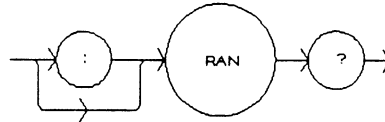

Parameters None. The response will be in the form:

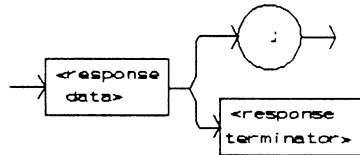

- where the response is an <nrf value>; 200 means 200 mA, and 500 means 500 mA range.

Notes The resolution and accuracy of the laser limit current are dependent on the laser drive current range.

Examples "RAN?" - response: 200, means the laser drive current output current range is 200 mA.
":Range?" - response: 500, means the laser drive current output current range is 500 mA.

SECUREFRONT PANEL
REMOTE

The SECURE command allows the service technician access to the protected user data command, *PUD, which is a common command. This data is normally changed only at the factory, and therefore the SECURE command is not needed by the user.

SET:FRONT PANEL
REMOTE

The SET: command path is used to get to the 3811's laser set point queries. The following commands may be reached directly from the SET: command path.

SET: CDC?

SET: LDI?

SET: PRI?

SET: CDC?

FRONT PANEL
REMOTE

The SET: CDC? query returns the constant duty cycle value which is used in constant duty cycle present (CONST %) mode.

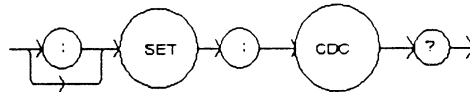

Parameters None. The response will be in the form:

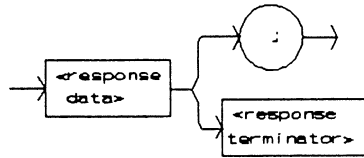

- where the response is an <nrf value> which represents the constant duty cycle set point value, as a percentage.

Notes The set point value does not change when the laser drive current output mode is changed. The actual duty cycle percentage may vary from the set point. If a (set point) value of CDC is entered which is not valid (due to the present PW and the limitation of CDC based on the resolution of PW and PRI), the CDC value will automatically be adjusted to the closest valid value. For more information, see the CDC command.

Examples "SET: CDC?" - response: 50.0, means the constant duty cycle set point is 50.00%.
"set:cdc?" - response: 12.01 means the constant duty cycle set point is 12.01%.

SET:LDI?FRONT PANEL
REMOTE

The SET:LDI? query returns the laser drive current set point value which is used for both output ranges.

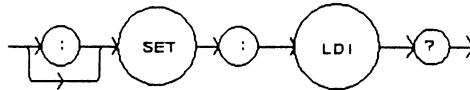

Parameters None. The response will be in the form:

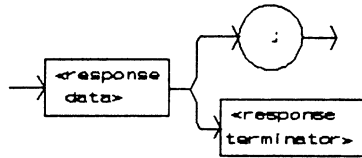

- where the response is an <nrf value> which represents the laser drive current set point value, in mA.

Notes The set point value does not change when the laser drive current range is changed, unless it is over the limit for the new range. In that case, it would be changed to the limit value of the selected range.

Examples "SET:LDI?" - response: 50.0 means the laser drive current set pint value is 50.00 mA.
"set:Ldi" - response: 120.0 means the laser drive current set point value is 120.00 mA.

SET:PRI?

FRONT PANEL
REMOTE

The SET:PRI? query returns the constant pulse repetition interval set point value which is used in CONST PRI mode.

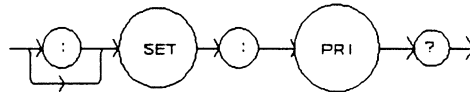

Parameters None. The response will be in the form:

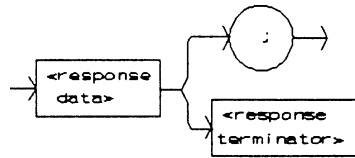

- where the response is an <nrf value> which represents the constant pulse repetition interval set point value, in uSec.

Notes The set point value does not change when the laser drive current output mode is changed.

Examples "SET:PRI?" - response: 50.0 means the PRI set point (for constant PRI mode) is 50.0 uSec.
"set:pri?" - response: 120.3 means the PRI set point (for constant PRI mode) is 120.3 uSec.

STEP

FRONT PANEL
REMOTE

The STEP command is used to increment or decrement the selected laser drive current set point by the given amount, when used with the INC or DEC command.

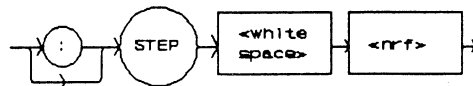

Parameters A value of the step amount, in the range 0.01 to 99.99 mA.

Notes The step of 1 corresponds to 1.00 mA.

Examples "ldi 20; Step 1; Inc; set:ldi?" - action: sets the step to 1.0 mA, so the set:ldi? query will return a value of 21.00 mA.

"STEP 10" - action: sets the step size to 10.00 mA.

STEP?

FRONT PANEL

REMOTE

The STEP query is used to read back the STEP value. This value is used to increment or decrement the laser drive current set point by the given amount, when used with the INC or DEC command.

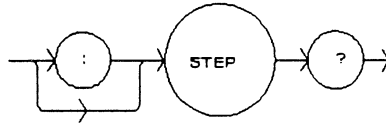

Parameters None. The response will be in the form:

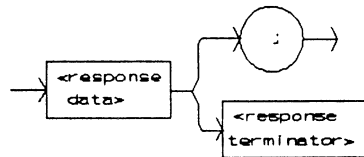

- where the response is an <nrf value> of the step amount.

Notes The step of 0.01 corresponds to a step of 0.01 mA. A step of 99.9 means 99.90 mA.

Examples "Step?" - response: 1.0 means the step size is 1.00 mA.
"STEP?" - response: 1E-01 means the step size is 0.10 mA.

TERM

FRONT PANEL
REMOTE

The TERM command allows the programmer to select the message terminator type for GPIB messages. <CR> (carriage return), <CR><NL> (new line), <CR><^END> (EOI), <CR><NL><^END>, <NL><^END>, <NL>, and <^END> are allowed.

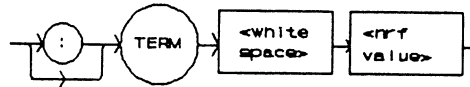

- Parameters** An <nrf value>, where 0 = <CR><NL><^END>, 1 = <CR><NL>, 2 = <CR><^END>, 3 = <CR>, 4 = <NL><^END>, 5 = <NL>, and 6 = <^END>.
- Notes** <CR><NL><^END> (0) is the default type. This is not truly the IEEE-488.2 specification. However, the <CR> character is ignored as <white space> by the IEEE-488.2 specification, so this terminator may be used with other IEEE-488.2 compliant instruments. (The <CR> has been left in our default terminator due to its historical usage).
Setting the terminator to anything other than number 4, <NL><^END> puts the 3811 out of compliance with the IEEE-488.2 specification. However, the other options are given here to allow compatibility with GPIB drivers which do not meet IEEE-488.2 specification.
Use of terminator number 3 is especially risky with other devices which comply with IEEE-488.2 specification. This is because the <CR> character is ignored, treated as <white space>. Therefore, if number 3 terminator is used, other IEEE-488.2 devices may wait indefinitely for message termination and “hang up” the GPIB.
- Examples** “TERM 5” - action: the <NL> (new line) terminator is selected. The 9072 will terminate a message with the <NL> character.
“Term 4” - action: the <NL> (new line) <^END> (EOI) terminator is selected. The 9072 will terminate a message with the <NL><^END> characters, in succession, and in that order.

TERM?FRONT PANEL
REMOTE

The TERM? query allows the programmer to determine which program message terminator is currently selected. <CR> (carriage return), <CR><NL> (new line), <CR><^END> (EOI), <CR><NL><^END>, <NL><^END>, <NL>, and <^END> are allowed.

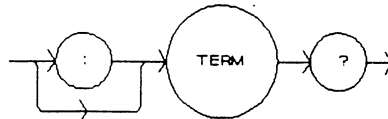

Parameters None. The response will be in the form:

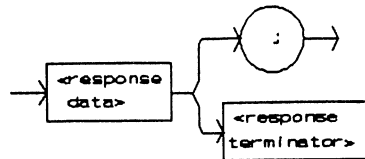

- where 0 = <CR><NL><^END>, 1 = <CR><NL>, 2 = <CR><^END>, 3 = <CR>, 4 = <NL><^END>, 5 = <NL>, and 6 = <^END>.

Notes <CR><NL><^END> (number 0) is the default type.

Use of any terminator, other than number 4, removes the 3811 from strict compliance with IEEE-488.2 standards.

Although the <CR> is recognized as <white space> by the IEEE-488.2 standard, it is used as a possible terminator in order to be compatible with GPIB products which do not meet IEEE-488.2 specification.

Examples "Term?" - response: 0 means the selected program message terminator is the <CR><NL><^END> characters, in succession, in that order.
"TERM?" - response: 2 means the selected program message terminator is the <CR><^END> characters, in succession, and in that order.

TIME?

FRONT PANEL
REMOTE

The TIME? query allows the programmer to determine how much time has passed since the 3811 was last powered up.

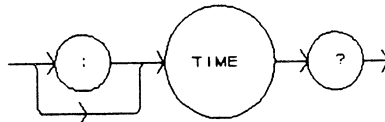

Parameters None. The response will be in the form:

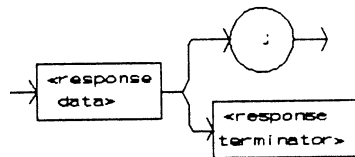

- where the response is character data in the form: hours:minutes:seconds.

Notes The TIME clock is independent of the TIMER clock.
The clock “turns over” after about 1193 hours.

Examples “Time?” - response: 0:01:02.36 means that 1 minute and 2.36 seconds have passed since the 3811 was powered up.
“TIME?” - response: 0:32:00.76 means that 32 minutes and 0.76 seconds have passed since the 3811 was powered up.

TIMER?

FRONT PANEL

REMOTE

The **TIMER?** query allows the programmer to determine how much time has passed since the last **TIMER?** query was issued.

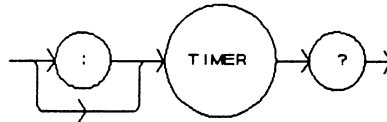

Parameters None. The response will be in the form:

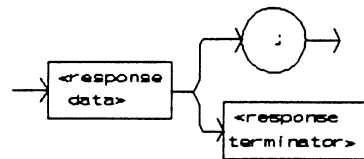

- where the response is character data which represents hours:minutes:seconds.

Notes Each time the **TIMER?** query is issued, the timer is reset to 0 and the elapsed time since the last **TIMER?** query is returned.

The timer counter is initially set at power up, the same as the **TIME?** counter. The first time the **TIMER?** is issued its response will be the same as a **TIME?** query's response.

The clock "turns over" after about 1193 hours.

Examples "Timer?" - response: 0:02:00.31 means the 3811 has been on for 2 minutes and 0.31 seconds since the last **TIMER?** query was issued.

"TIMER?" - response: 0:00:12.03 means the 3811 has been on for 12.03 seconds since the last **TIMER?** query was issued.

Error Messages

Error messages may appear on the display when error conditions occur in the 3811.

In remote operation, the current error list can be read by issuing the "ERR?" query. When this is done, a string will be returned containing the previously unread error messages (up to ten) which are currently in the error message queue.

Appendix A contains an explanation of the error messages which may be reported by the 3811 on the display or via remote operation.

LDP-3811 Programming Examples

This section is intended as a simple example of programming the 3811 over the GPIB. The first short examples contain sections of a BASIC program. These examples are not complete programs, and therefore cannot be used by themselves. However, they illustrate the simplicity of programming the 3811, and show some possible uses of its features. The initialization of variable and files has been omitted for simplicity.

The following BASIC programming example, Example Program 3.1, exercises the constant duty cycle mode of the 3811, and it demonstrates the DELAY, and STEP commands. This example assumes the use of a subroutine for "talking to" and 3811 over the GPIB.

```

210 CMD$ = "Mode: CDC; PW 2; CDC 5" : GOSUB 1000      'Set CDC mode, PW 2 uSec, duty cycle 5%
220 CMD$ = "Step 1" : GOSUB 1000                    '1.00 mA step
230 CMD$ = "LDI 40; Output ON" : GOSUB 1000         'Start laser current at 40.00 mA
240 FOR X=1 TO 10                                   'Step laser current from 40 to 50 mA
250   CMD$ = "Delay 2000; Inc" : GOSUB 1000        'Wait 2 seconds between each step
260 NEXT X                                           'and increment LDI by 1.00 mA

```

Figure 3.3 Step and Delay Example Program

The following BASIC programming example, Example Program 3.2, demonstrates the use of the PW, CDC and SET:CDC? commands. This program example assumes the use of a subroutine for talking to the 3811 over the GPIB.

```
300 CMD$ = "Mode:CDC; PW 50" : GOSUB 1000      'Set CDC mode, pulse width 50.0 uSec
310 CMD$ = "Output OFF" : GOSUB 1000         'Output off
320 CMD$ = "Ran 200; Lim:I200 100" : GOSUB 1000 'Set output range to 200 mA, limit to 100 mA
330 CMD$ = "Output ON" : GOSUB 1000         'Turn output on
340 CMD$ = "CDC .05"                          'Set duty cycle to 0.05%
350 CMD$ = "SET:CDC?" : GOSUB 1000         'Check the set point to see if it is changed
360 INPUT#2,P$                                'Input the set point
370 PRINT P$                                  'Print the actual set point to the screen
```

Figure 3.4 Constant Duty Cycle Example Program

GPIB/IEEE-488.2 REMOTE OPERATION

Introduction

When the model 1231 GPIB/IEEE-488.2 interface is installed and the instrument is connected to a host computer, the LDP-3811 can be used as a remotely controlled laser diode pulsed current source.

In remote operating mode, the 3811 offers all of the features accessible from the front panel and some additional features which can only be accessed via the interface bus. In remote mode you have access to commands for functions not found on the front panel. Additional functions include the STEP command (which automatically increments or decrements the laser drive current set point by a user-defined step value), 5-digit resolution of laser diode current values, and control of the conditions which cause the OUTPUT to be shut off.

The model 1231 GPIB/IEEE-488.2 interface allows GPIB/IEEE-488.2 bus control of the LDP-3811. Information can also be read by the host computer and printed or stored. Other features include:

- A concise and straight-forward command set
- Full talk/listen capability
- Full serial poll capability, with SRQ
- Full local/remote capability including LOCAL LOCKOUT
- Meets ANSI/IEEE-488.2-1987 standards

This chapter is a guide to the syntax and usage of the various IEEE/488.2 common commands available for the 3811. It also includes advanced programming tips for remote use with the device-dependent commands, hardware diagrams, and other information relating to remote operation.

This chapter is divided into three parts. The first part has the information for using the GPIB with the 3811. It also has sections for each common GPIB (ANSI/IEEE-488.2) command which is supported by the 3811. The second part contains information on advanced programming techniques and status reporting.

The third part contains information on remote interface messages; these low-level messages are generally transparent to the user.

Preparation for Bus Control

To use the LDP-3811 remotely, you will need to install an IEEE-488 interface adapter in your host computer. These adapters and support software are available from several manufacturers and can be installed in most computers. This manual assumes that you have a basic knowledge of the GPIB/IEEE-488 interface bus and how to use it for instrument control. This chapter also assumes that you are familiar with the controls on the LDP-3811. Review Chapter 2 if you need more details on how to operate the LDP-3811.

The talk and listen addresses on the 3811 are identical. This GPIB address is read locally by pressing the LOCAL/ADR switch and reading the display. To set the GPIB address, press and hold in the SET switch while displaying the GPIB address. Turn the ADJUST knob until the desired address value is displayed, then release the SET switch. The new GPIB address will then be stored in non-volatile memory. The allowable address range is 0 - 30 for primary GPIB addressing. It is not normally possible to exceed this range. However, if the GPIB address were to somehow exceed 30, it would not "hang up" the bus. Extended GPIB addressing is not implemented on the 3811.

Getting Started with GPIB

This section is intended as a quick guide to the GPIB syntax and commands used by the 3811. The 3811's unique (device-dependent) commands are described in Chapter 3.

Overview of the 3811 Syntax

Generally, a command or query is entered (spelled) as shown in Table 3.1. The command/query **MUST CONTAIN** all of the letters which are shown in upper case in Figure 3.2 and Table 3.1. However, the 3811's command parser is **NOT CASE SENSITIVE** so upper or lower case may be used in any combination. The lower case letters shown with the commands in Section 3.4 are optional letters, and may be used for clarity. For example, the following commands are equal, and only the first three letters "DIS" are required, while the other letters, "play" are optional,

"DIS 1", "DISPLAY 1", and "DisP 1".

The syntax of the 3811 commands follows the rules laid out in the IEEE-488.2 standard. Colons (:) indicate the start of a new command path, while semicolons (;) indicate a separation of commands within a command string. A leading semicolon on a command may be used to return the 3811 command parser to the command path root (see Figure 3.2).

Spaces or white space (see Section 4.6.2 for a definition of white space) may be placed anywhere in a command string (after the command header or query question mark), and a single space must be used to separate the command (header) from the first parameter (or program data). The following examples show valid syntax for commands with the 3811:

```
"MODE:CDC; Pw 1.0; CDC 25; Ldi 50; OUT 1"
":DIS 1; :set:ldi?;
"limit:i200 40"
"display:ldi"
```

The following are examples of invalid syntax for the 3811. These command strings would produce an erroneous result, as explained:

```
"MODE CDC"; Missing colon, MODE? expected
"MODE:CDC;CDC 25"; Second "CDC" command is still under the "MODE:" path, so the
3811 generates an "unexpected parameter error". This could be fixed by using the form,
"MODE:CDC; :CDC 25".
"MODE:LDI DEC"; Missing semicolon, DEC command generates an error
"DIS ?"; Space not allowed before question mark, DIS  command expected.
"LDI33;dis?"; Space missing between LDI command and the parameter value, 33.
```

"Disply"; Optional letters must follow the correct order. Therefore, "Dis", "Disp", "Displ", "Displa", or "Display" are equivalent.

Using Commands with Parameters

Some commands expect a parameter. For example, if the duty cycle set point is to be entered, the command could be "CDC 30". This would set the 3811's duty cycle 30.00% for use in constant duty cycle mode. If a single parameter is expected, it should follow the command with at least one space between the command and the parameter.

The nominal value for on/off parameters is 1 = on, 0 = off. For example, the command:

"Display 1" - turns the 3811's display on, and

"Display 0" - turns the 3811's display off.

The words "on" and "off" may be substituted in the above example:

"Display On" - turns the 3811's display on, and

"Display OFF" - turns the 3811's display off.

For more information on parameter name substitutions, see Chapter 3.

A query has no space between the mnemonic and the question mark, as in:

"LDI?"

The 3811 uses a terminator of <CR><NL><^END> (carriage return, new line, EOI). In almost all cases, these terminators are automatically inserted by the host (user's) computer or GPIB driver. For more information, see Section 4.6.5 or the IEEE-488.2 standard definition.

Common Commands and Queries

This section contains a list of the common commands and queries which are supported by the 3811. The common commands and queries are distinguished by the * which begins each mnemonic. The common commands and queries are listed in alphabetical order, and a brief description of their functions is given. For more information on these commands, refer to an ANSI/IEEE 488.2-1987 standards reference.

*CAL?

This is the calibration query. When it is sent, the 3811 performs the A to D calibration procedure. After this query is sent, the 3811 responds with a message indicating that calibration has been completed successfully or unsuccessfully. A response of 0 means no errors, any other number means an error in calibration was detected.

An auto-calibration is performed each time the 3811 accumulates 10 minutes of inactive time since the last auto-calibration. The syntax for the *CAL? query is:

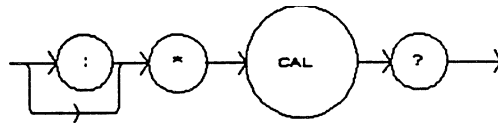

*CLS

This is the Clear Status command. It is used to clear the status event registers. It may be used, for example, to clear the Event Status Register, the Standard Event Status Register, and the Error Queue before enabling SRQ generation from instrument events. The syntax for the *CLS command is:

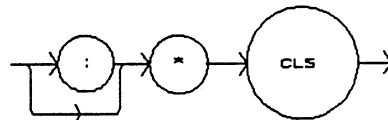

*DLF

This is the Disable Listener Function command. It is used to cause the 3811 to cease being a listener. The syntax for the *DLF command is:

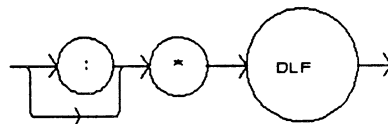

*ESE

This is the Standard Event Status Enable command. This command enables the Standard Event Status Register to update bit 5 of the status byte. The Structure of the Standard Event Status Enable Register and Standard Event Status Register are shown in Figure 4.1. The contents of these two registers is logically ANDed then the bits are ORed to get the Event Summary Bit message.

The syntax for the *ESE command is:

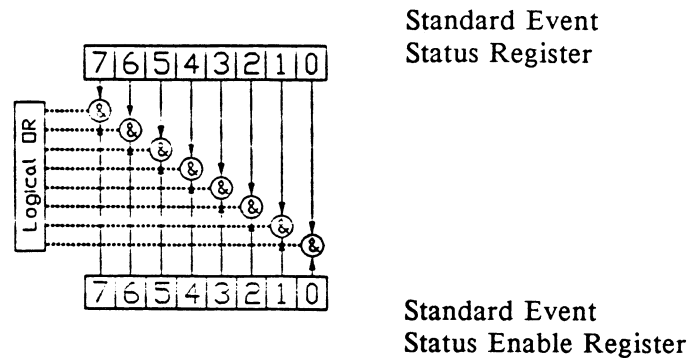

Bit Reference-

0- Operation Complete	4- Execution Error
1- N/A	5- Command Error
2- Query Error	6- N/A
3- Device Dependent Error	7- Power On

Figure 4.1 Standard Event Status Register / Standard Event Status Enable Register

Setting bit 0 allows the user to poll or generate SRQ from any overlapped commands after any previous operations are completed. This may be useful for ensuring that an operation, such as OUTPUT on, is complete before a measurement is made. Although this could be performed without using service requests, an interrupt-driven program makes more efficient use of the GPIB than polling or waiting (*WAI) routines. (See also Section 4.7.2).

*ESE?

This query will cause the 3811 to return the value of the Standard Event Enable Register. This allows the user to determine which status bits can set the summary bit (bit 5) in the status byte register. The response will be the sum of all of the enabled bits, as represented in Figure 4.1.

The syntax for the *ESE? query is:

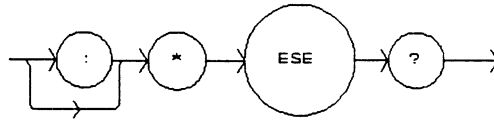

*ESR?

This query will cause the 3811 to return the value of the Standard Event register. This allows the user to determine which type of error has occurred, for example. The value of the response will be the sum of the bits as represented in Figure 4.1.

The syntax for the *ESR? query is:

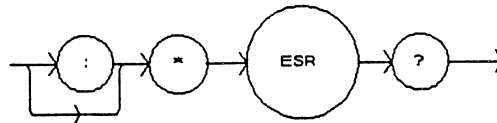

*IDN?

This query will cause the 3811 to return the following identification string:

ILX,LDP-3811,(7-digit serial number),(2-digit software version number). This identifies the specific device for the user. The manufacturer, model, serial number, and version number are listed in order.

The syntax for the *IDN? query is:

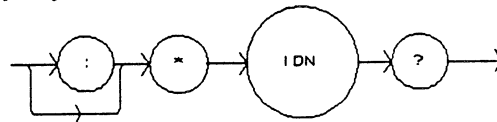

*IST?

The Individual Status query allows the user to read the current state of the IEEE-488.1 'ist' local message in the 3811. The response is a 1 or 0. A '1' indicates that the message is true, and a '0' indicates that the message is false.

The syntax for the *IST? query is:

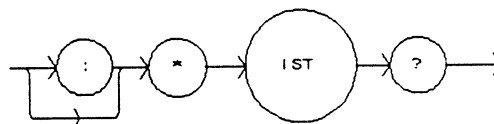

***OPC**

The *OPC command causes the 3811 to generate the operation complete message in the Standard Event Status Register when all pending overlapped commands have been completed.

The syntax for the *OPC command is:

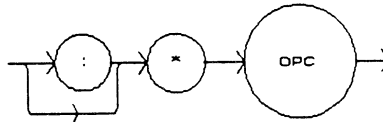
***OPC?**

This query places an ASCII character 1 into the 3811's Output Queue when all pending operations have been finished. (See also Section 4.7.2)

The syntax for the *OPC? query is:

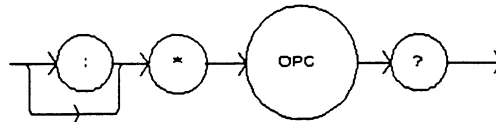
***PRE**

This is the Parallel Poll Register Enable command. It sets the parallel poll register enable bits for the format required by the 3811 in order that it may participate in parallel polling from the controller. The syntax of this command is:

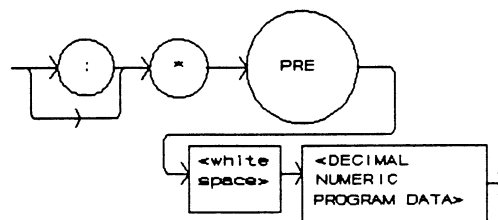

where - the value of the data must round off to an integer value between 0 and 65535

the value of the data corresponds to the sum of all of the enabled bits desired for parallel polling (see Figure 4.2).

The Parallel Poll Enable Register is ANDed with the Status Byte Register. This result is ORed to form the ist (individual status) local message, as seen in Figure 4.2.

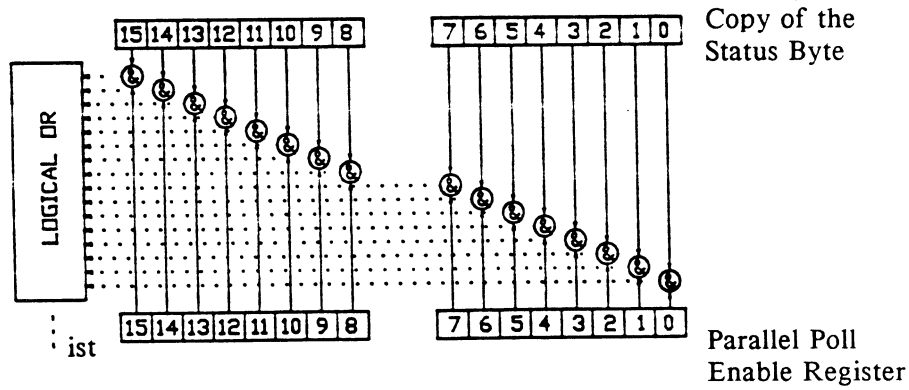

Bit Reference-

0- N/A	4- Message Available	8- N/A	12- N/A
1- N/A	5- Event Status Summary	9- N/A	13- N/A
2- Event Summary	6- Master Status Summary	10- N/A	14- N/A
3- Condition Summary	7- Error Message Available	11- N/A	15- N/A

Figure 4.2 Parallel Poll Response Handling Data Structure

***PRE?**

This query allows the programmer to determine the contents of the Parallel Poll Enable Register. The response will be the sum of the register bits, as represented in Figure 4.2.

The syntax for the *PRE? query is:

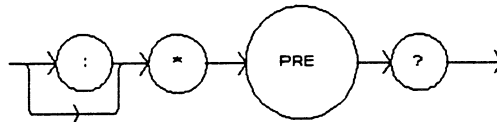

***PSC**

The Power-on Status Clear command controls the automatic power-on clearing of the Service Request Enable Register, the Standard Event Status Enable Register, the Event Status Enable Register, the Condition Status Enable Register, and the Parallel Poll Enable Register. The syntax for this command is:

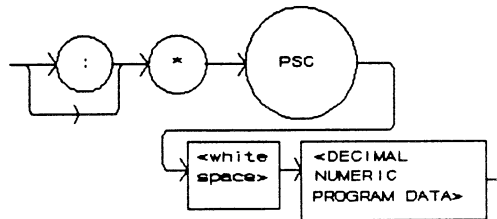

where - a value which rounds to an integer value of 0 means the power-on-status-clear flag of the 3811 is set FALSE, therefore disallowing SRQ (interrupts) to be asserted after power-on.

a value which rounds to any non-zero integer value between -32767 and +32767 means the power-on-status-clear flag of the 3811 is set TRUE, therefore allowing SRQ (interrupts) to be asserted after power-on.

When the "*PSC 1" command is sent, the 3811 will clear the above-mentioned enable registers (set them all to 0) at power-up. This may be done to avoid any undesirable service requests after a power on/off cycle of the 3811.

The factory default value for this bit is 0, Power-on Status Clear is disabled. Therefore, the values of the enable registers are restored from their condition at the last power-down when a power-up occurs.

***PSC?**

The Power-on Status Clear Query allows the programmer to query the 3811's power-on-status-clear flag. A response of 0 means that the Standard Event Status Enable Register, Service Request Enable Register, the Event Status Enable Register, the Condition Status Enable Register, and the Parallel Poll Enable Register will retain their values when power is restored to the 3811. A returned value of 1 indicates that the registers listed above will be cleared when power is restored to the 3811. The syntax for this query is:

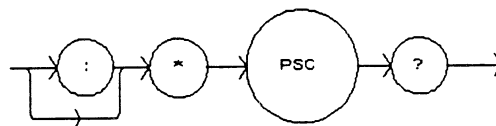

*PUD

The Protected User Data command stores data unique to the 3811, such as calibration date, serial numbers, etc. This data is protected by restricted entry ("SECURE <nrf>" command) and is usually only entered at the time of service or calibration.

This data is a fixed size of 18 bytes. The syntax of the *PUD command is:

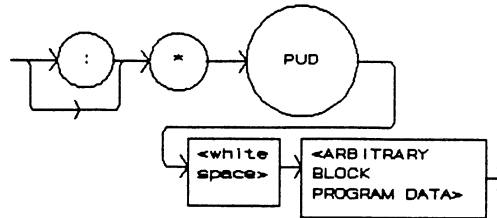

-where the user's input (unique data) is exactly 18 bytes.

*PUD?

The Protected User Device query allows the user to retrieve the contents of the *PUD storage area. The response is the contents of the unique data which was last entered. The syntax of the *PUD? query is:

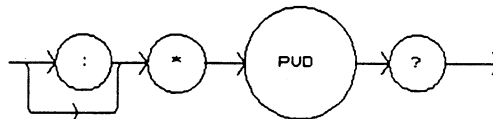

The initial (factory set) response value of the *PUD? query is:

#218nnnnnnvMMDDYYABC

-where the response is <ARBITRARY BLOCK RESPONSE DATA>: nnnnnn represents the 7-digit serial number, vv represents the software version number, MMDDYY represents the date of calibration (month, day, year), and ABC represents the initials of the calibrating technician.

*RCL

The *RCL (Recall) command restores the 3811 to the setup state which is in its local memory (Bin 0 - 10). The following criteria are restored when the *RCL command is given:

1. The 3811 is in the parameter state which was last stored in that bin.
2. The OUTPUT is off.

The syntax for the *RCL command is:

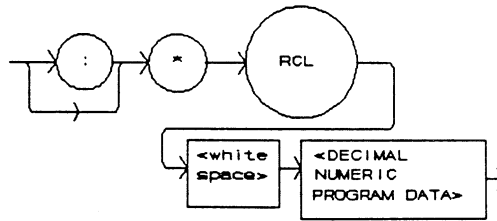

-where the value must round-off to an integer between 0 and 10. A value of 0 means the recalled state shall be the same as that of a *RST command (see Table 4.1). Up to 11 different stored recall states can be used. Ten of these recall states (1 - 10) are saved by using the *SAV command.

*RST

The *RST (Reset) command performs a device reset. This has the same effect as *RCL 0 (see Table 4.1), but additionally the 3811's OCIS and OQIS idle states are set with the *RST command.

The Operation Complete Command Idle State (OCIS) is the state which the 3811 is in when it is no longer waiting for any operation to complete, after an *OPC command has been executed.

The Operation Complete Query Idle State (OQIS) is the state which the 3811 is in when it is no longer waiting for any operation to complete, after an *OPC? query has been executed.

These idle states allow the 3811 to complete its reset process (and have no operations pending) before continuing with any other commands after the *RST is executed.

The syntax for the *RST command is:

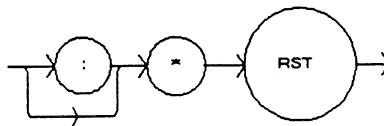

*SAV

The Save command stores the current state of the 3811 in non-volatile local memory. A particular state is then recalled by using the *RCL recall command (see Section 4.3.17). There are 10 unique states which can be stored. The syntax of the *SAV command is:

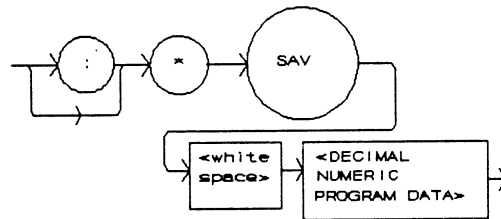

-where the value must round off to an integer between 1 and 10. The rounded integer value corresponds to a unique saved state which can be recalled by using the same value with the *RCL command.

*SRE

The Service Request Enable command sets the Service Request Enable Register bits to allow the 3811 to generate the user-selectable service requests. The syntax of the *SRE command is:

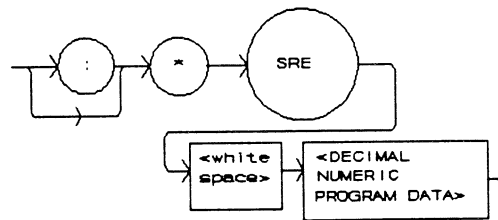

-where the value of the numeric data rounds off to an integer between 0 and 255. The value of the numeric data corresponds to the bits enabled (see Figure 4.3)

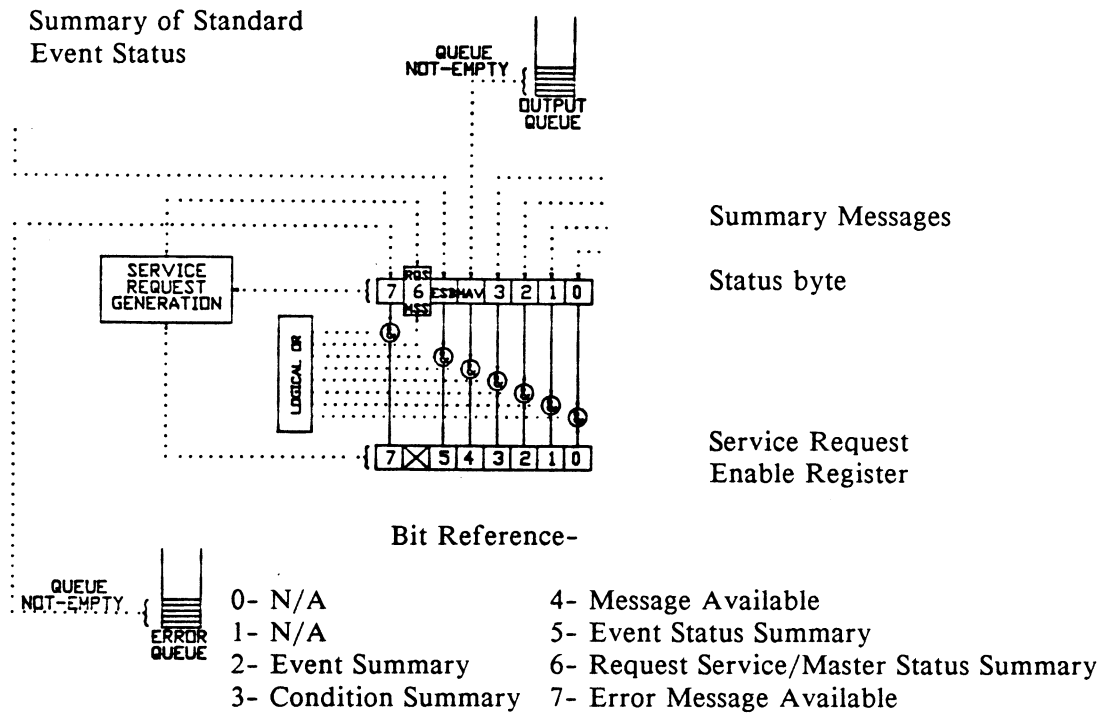
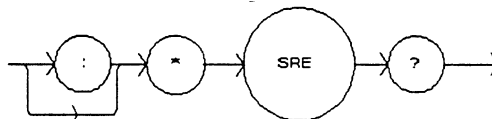

Figure 4.3 Service Request Enable Register

***SRE?**

The Service Request Enable query allows the user to determine the current contents of the Service Request Enable Register. When this query is made, the response is the binary integer value of the contents of the register (see Figure 4.3). The syntax of the *SRE? query is:



*STB?

The Read Status Back query allows the programmer to read the status byte and Master Summary Status bit. The response to this query is an integer value of the contents of the Status Byte Register, where bit 6 represents the MSS (Master Summary Status) bit and not the RQS message (see Figure 4.3). The syntax of the *STB? query is:

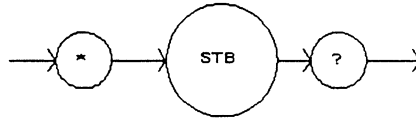

*TST?

The Self-Test query causes an internal self-test and returns a response when the self-test is complete. The syntax of the TST? query is:

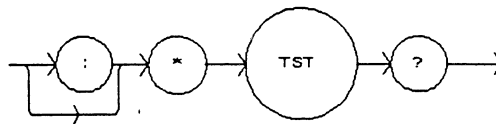

The response is <DECIMAL NUMERIC RESPONSE DATA>, where the value of the response is 0 if the self-test completes with no errors. If the response is a value other than 0, the self-test was not completed or it was completed with errors detected.

*WAI

The Wait-to-Continue command prevents the 3811 from executing any further commands until the No-Operation-Pending flag is true. This allows the programmer to make the 3811 wait for the completion of an operation before continuing. For more information on the operation complete (OPC) flag, see section 4.7.2.

The syntax for the *WAI command is:

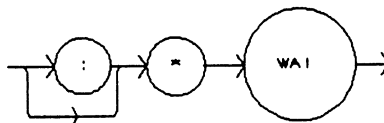

Advanced Programming

Once you have become familiar with the command syntax and structure, you may take advantage of some programming shortcuts which are available. Due to the "tree-walking" capabilities of the 3811 software, the user may elect to write command strings without constantly repeating the entire command path for each command.

Path Specification

The first command in the string must have its entire path entered. But once a path level is reached, other commands which are at the same level (or higher level) may then be entered without repeating the path. To accomplish this, the semicolon (;) must be used to separate the commands in the string, as usual. However, the command following the semicolon need not specify its full path, if the same path which was previously written out could be used for the new command.

For example, the following legal command string could be used to (1) set the 3811 display to the laser drive current and then (2) set the display for the constant duty cycle set point value:

```
"DIS:LDI; CDC"
```

The path "DIS:" is "remembered" by the 3811 software in this case. If the "CDC" command were not found at this level, the software would walk back to the "root" level and search for a "CDC" command. If the command is not found, an error message will be generated. (In this case, if there were no "DIS:CDC" command the 3811 software would try to execute the "CDC" command and would generate an error because there was no parameter value given.)

Care must be taken to avoid errors which are caused by trying to implement commands from the wrong path or level. For example, the following command string was intended to (1) read back the set point duty cycle percentage and (2) read back the measured laser drive current:

```
"SET:CDC?; LDI?"
```

Instead, the 3811 would return the set point duty cycle percentage and the laser drive current set point. When the "LDI?" is encountered, the software will first search for that command at its present level. Since it finds it there the SET:LDI? query will be executed. If this command did not exist at this level, the software would search down to the "root" level and find and execute the intended command, "LDI?".

In order to ensure the proper command is executed for the example above, the following command string should have been issued:

```
"SET:CDC?; :LDI?"
```

The use of the colon forces the search for the "LDI?" query to begin at the root level, and thus the desired effect is achieved.

If you are not sure of the path level of a command, refer to the 3811 Command Path Structure diagram, Figure 3.2. For this discussion, the root level is the highest level, and moving down the diagram (Figure 3.2) decreases the level.

Once the software has "walked" to a lower path level, it remains at that level when it receives the next command.

The only exception to the rule described above is when common commands are used. In that case, the software remembers which level the user was at before the common command was found, and it returns to that same level after finding and executing the common command. Therefore the following command string is legal:

```
"DIS:CDC; *SAV 1; LDI"
```

Here, (1) the display is set to show the set point duty cycle percentage, (2) the present setup is stored in "bin" 1, and (3) the display is set to show the laser drive current.

Error Messages

Error messages may appear on the 3811 display when error conditions occur which force the output off or reflect hardware errors in the 3811.

In remote operation, the current error list can be read by issuing the "ERR?" query. When this is done, a string will be returned containing (up to 10 of) the error messages which are currently in the error message queue.

Appendix A contains an explanation of the error messages which may be reported remotely by the 3811.

ANSI/IEEE-488.2 Definitions

The following sections contain the relevant definitions for syntax diagrams and syntax elements for the 3811 commands, as defined by the IEEE-488.2 standard. A complete listing of that standard is not practical here, but these definitions are applicable to the remote operation of the 3811.

Syntax Diagrams

The syntax diagrams in Section 3.4 show the most complete form of command construction, but they don't show every possible construction. Some of the other possibilities which are not shown in the syntax diagrams of Section 3.4 are discussed in Section 4.4, Advanced Programming. These syntax diagrams conform to the ANSI/IEEE-488.2-1987 standard, and the terminology presented here reflects that standard.

	The oval (or round) shape contains a terminal syntactic element. These represent a basic function, such as a single ASCII character, which cannot be divided.
	Rectangles contain non-terminal syntactic elements. These represent elements which are expandable to a diagram of terminal syntactic elements. However, they are presented as a unit for clarity or emphasis.
	Lines and arrows indicate correct paths through the syntax diagram. A reverse line around an element indicates that the element may be repeated indefinitely. A forward arrow around an element indicates that the element may be omitted.

White Space

White space is defined by the syntactic diagram shown in Figure 4.4, where <white space character> is defined as a single ASCII-encoded byte in the range 00-09, 0B-20 (0-9, 11-32 decimal). This range includes the ASCII control characters, carriage return, and the space, but excludes the newline character.

In most practical programming situations, the space character (space bar) would be used as white space. White space is generally used for separating other syntactic elements. White space is processed by the 3811 without interpretation.

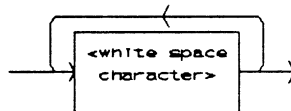

Figure 4.4 White Space Syntactic Diagram

Power-on Conditions

At power-on, the 3811 complies with the ANSI/IEEE Std 488.2-1987 requirements. It will initialize the setup parameters to be the same as when the power was last shut down. However, the OUTPUT will be off at power-up. The default conditions may be recalled by using the *RST command. The default conditions are outlined in Section 4.6.12.

<nrf value>

The symbol, <nrf value>, refers to the flexible numeric representation, as defined by the IEEE-488.2 standard. All this means is that numbers may be represented in one of three forms, integer, floating point, or engineering/scientific notation. For example the number "twenty" can be represented by an ASCII string of:

- 20 or +20
- 20.0 or +20.0
- 2.0E+1 or +2.0E+1 or 2.0e+1 or +2.0e+1

These three forms are denoted, NR1, NR2, and NR3, respectively, by the IEEE-488.2 standard. For more information on the precise syntax of these definitions, refer to the IEEE-488.2 standard.

<PROGRAM MESSAGE TERMINATOR>

When you send a command using the standard format, the host computer (or GPIB driver) usually puts a <CR><NL><^END> (carriage return-line feed-EOI) on the data bus following the command string. The IEEE-488.2 standard requires either <NL><^END>, <NL>, or <^END> as an acceptable <PROGRAM MESSAGE TERMINATOR>, while the <CR> is treated as <white space> (ignored). The 3811 will accept any <PROGRAM MESSAGE TERMINATOR> shown in Figure 4.5. The 3811 terminates its responses with a <CR><NL><^END> (unless the user changes the terminator via the TERM command).

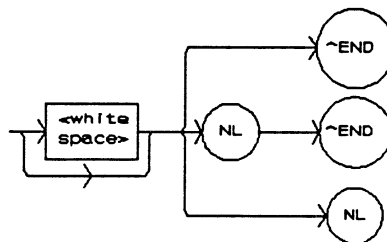

Figure 4.5 <PROGRAM MESSAGE TERMINATOR> Syntax Diagram

If you encounter problems with GPIB communications with the 3811, refer to your GPIB driver manual for the exact syntax of the output terminator.

<PROGRAM MESSAGE UNIT SEPARATOR>

A <PROGRAM MESSAGE UNIT SEPARATOR> is used to separate sequential <PROGRAM MESSAGE UNIT> elements (commands) from one another within a <PROGRAM MESSAGE>. The syntax for a <PROGRAM MESSAGE UNIT SEPARATOR> is shown in Figure 4.6.

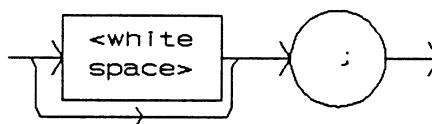

Figure 4.6 <PROGRAM MESSAGE UNIT SEPARATOR> Syntax Diagram

<PROGRAM HEADER SEPARATOR>

The <PROGRAM HEADER SEPARATOR> separates the <COMMAND PROGRAM HEADER> (3811 command) from the <PROGRAM DATA> (first parameter after the command). In the case of the 3811, a single white space must

be used to separate the command from the first parameter. Note however, commands may be compounded.

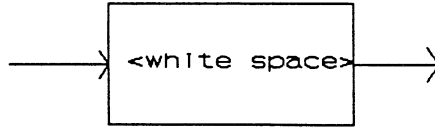

Figure 4.7 <PROGRAM HEADER SEPARATOR> Syntax Diagram

<compound command program header>

A <compound command program header> is a compound command heading which may be followed by <program data> (parameters). The 3811 command structure is a tree, as shown in Figure 3.2. A compound command or <compound command program header> determines the proper command by following a path from the root node. This is similar to determining a path for a file by starting with the root directory and listing the intermediate subdirectories. The syntax for a <compound command program header> is shown in Figure 4.8. The syntax diagram for a <compound query program header> is shown in Figure 4.9.

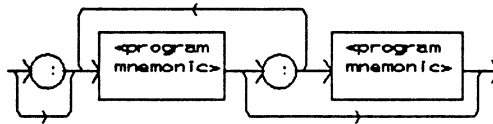

Figure 4.8 <compound command program header> Syntax Diagram

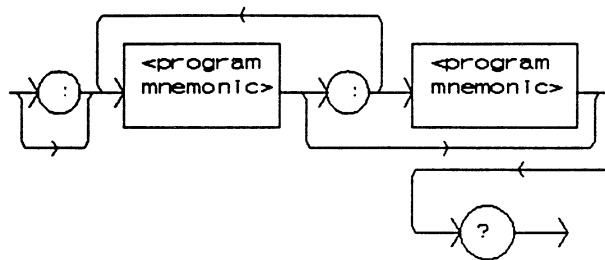

Figure 4.9 <compound query program header> Syntax Diagram

A <program mnemonic> is a command or command path identifier. For example, the <PROGRAM MESSAGE> "DISplay:LDI" consists of the command "LDI" and the path identifier "DISplay." All of the legal <compound command program headers> may be traced by starting from the root node of the command structure and moving down by levels to paths, and finally to the command (see Figure 3.2).

A <PROGRAM MESSAGE TERMINATOR> causes the next command search to begin at the root node. A leading colon (:) on a <PROGRAM MESSAGE UNIT> will cause the 3811 to begin searching for the command at the root node. Otherwise (after a semicolon), the 3811 will first search the most recently used node for the command. It will continue to search the command tree until it finds a legal command path, by searching each previously used node up to the root. If no legal path is found, the 3811 will generate an error message. For more information on creating and using 3811 commands, see Section 4.4, Advanced Programming.

<PROGRAM DATA> (Parameters)

Parameters (and other <PROGRAM DATA>) may be entered after a command in a <PROGRAM MESSAGE UNIT>. The <COMMAND PROGRAM HEADER> (command) and first <PROGRAM DATA UNIT> (parameter) must be separated by a <PROGRAM HEADER SEPARATOR> (white space), see Section 4.6.6.

<ARBITRARY BLOCK PROGRAM DATA>

This element allows any 8-bit bytes (including extended ASCII) to be transmitted in a message. The syntax for an <ARBITRARY BLOCK PROGRAM DATA> element is:

-where a non-zero digit is defined as a single ASCII encoded byte in the range 31 - 39 (49 - 57 decimal). 8-bit data byte is defined as an 8-bit byte in the range 00 -FF (0 -255 decimal). NL is a new line (LF) and ^END is an end or identify (EOI).

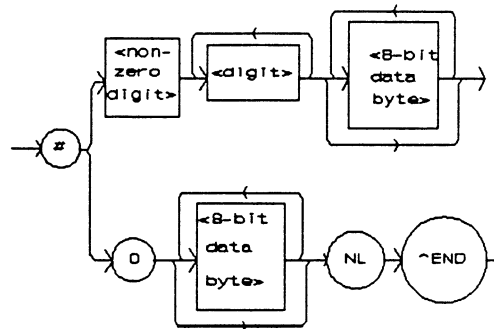

Figure 4.10 <ARBITRARY BLOCK PROGRAM DATA> Syntax Diagram

This element is used only with a *PUD command to the 3811.

<PROGRAM DATA SEPARATORS>

When there is a list of <PROGRAM DATA UNITS> (parameters) following a <PROGRAM HEADER SEPARATOR> (white space), the <PROGRAM DATA UNITS> must be separated with a <PROGRAM UNIT SEPARATOR>. The syntax diagram for a <PROGRAM UNIT SEPARATOR> is shown in Figure 4.11.

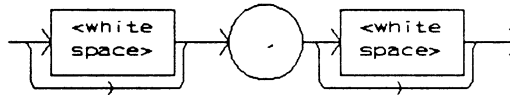

Figure 4.11 <PROGRAM DATA SEPARATOR> Syntax Diagram

Default Parameters

There are no default values for omitted parameters. If a command is expecting a parameter and none is entered, an error will be generated.

However, if a reset is performed via a *RST command (or a RCL 0 command), the following parameters will be set to the default state shown in Table 4.1.

Table 4.1 State of the 3811 After *RST

GPIB mode in LOCAL via front panel, or in REMOTE via GPIB
PARAMETERS not selected
LIM 200 (200 mA range) = 200 mA
LIM 500 (500 mA range) = 500 mA
OUTPUT off
MODE = CONST % (constant duty cycle %)
Pulse Width (PW) = 0.1 uSec
Pulse Repetition Interval (PRI) = 1.0 uSec
Duty Cycle % = 10.0%
Display showing current (in mA)
RANGE in 200 mA setting
Set Point = 0 mA
RECALL BIN number = 0
STEP value = 0.01

Status Reporting

Figure 4.12 shows the status reporting scheme of the 3811. Each of the registers which may be accessed by a command or query has the appropriate command or query written above or below the register representation. For example, the Condition Register may be queried via the laser controller "COND?" query, as shown by its register heading in Figure 4.12.

The condition or event registers are logically ANDed with their respective enable registers. These bits are then logically ORed to form a summary message in the status byte for that particular register.

Event and Condition Registers

The Event Registers are used to report events which occur during the operation of the 3811. Events differ from conditions in that events signal an occurrence once, and are not reset until the Event Register is queried or the 3811 is powered off. Conditions reflect the current state of the device, and therefore may change many times during operation. Querying a Condition Register does not change its contents.

The 3811 contains Event and Condition Registers for laser drive current controller operations. It also contains the Standard Event Status Register which reports events for general operation of the 3811. The Standard Event Status Register conforms to the IEEE-488.2 standard.

Operation Complete Definition

Note that bit 0 of the Standard Event Status Register contains the status of the Operation Complete flag (see *OPC, Section 4.3.9). Enabling this bit via the *ESE command allows the user to update bits of the status byte. Then, if the SRE mask has bit 5 set, and the user issues an *OPC command, an SRQ will be issued upon completion of the currently processed commands. This may be used to initiate service request routines which depend on the completion of all previous commands.

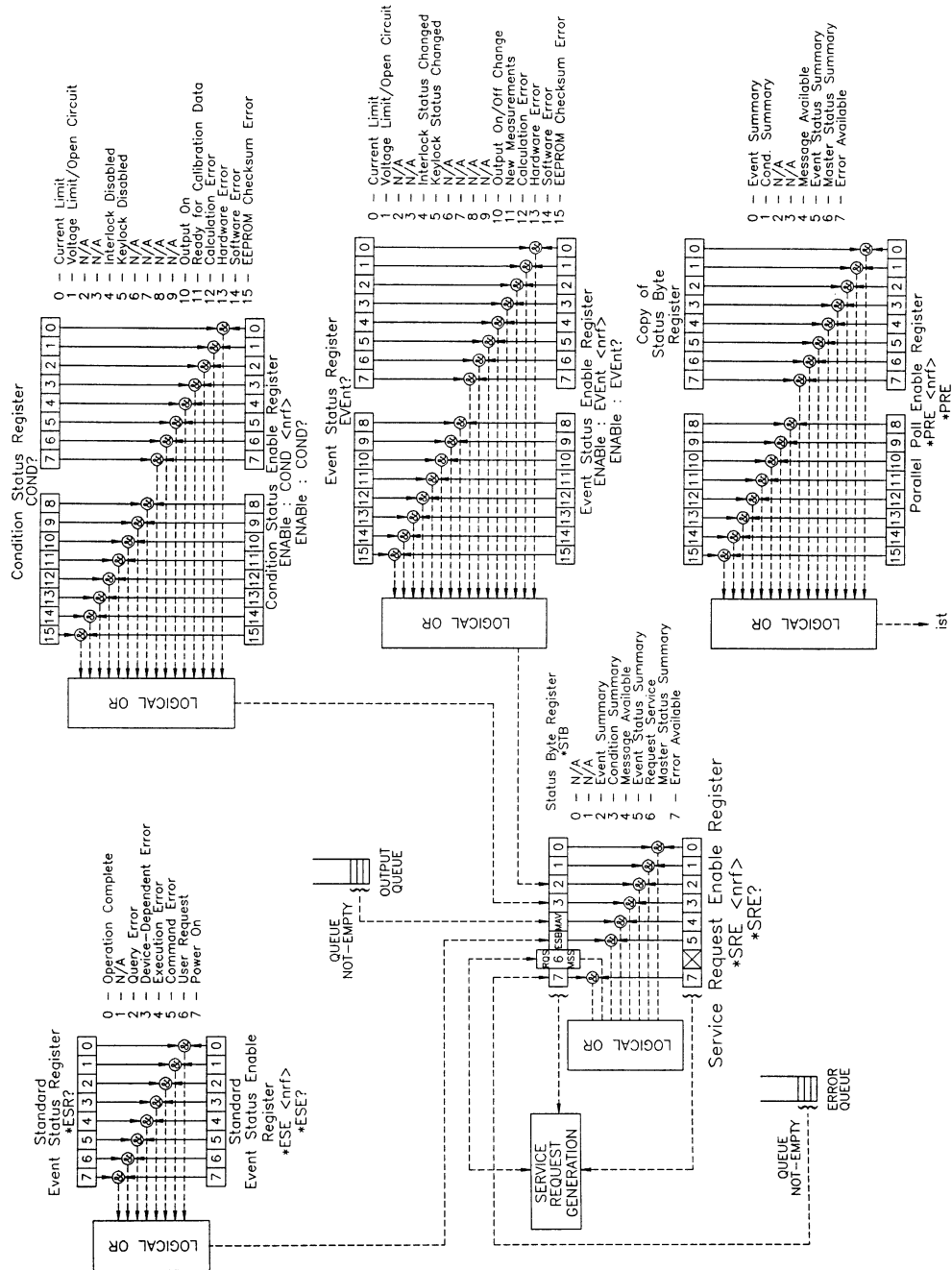

Figure 4.12 LDP-3811 Status Reporting Schematic Diagram

Operation Complete on the 3811 is defined as:

- 1 The controller, which is updating the current source hardware, is idle.
- 2 No NVRAM (non-volatile) memory write cycles are in progress.
- 3 A new current measurement is available.
- 4 No calibration routines are running.
- 5 The OUTPUT is off, or the OUTPUT is on and the output-on delay has finished (OUTPUT current is enabled).

Command Timing and Completion

This section describes, for each device-dependent command, whether that command is performed in an overlapped or sequential manner. In other words, it states whether the next command may begin while this command is being executed, or if the next command must wait until this command is completed before its execution begins. The conditions for setting the operation complete flag are given in Section 4.7.2.

All 3811 device-dependent commands are executed in an overlapped manner, and the operation complete flag is set after the conditions outlined in Section 4.7.2 have been satisfied.

The *WAI (common command) is an example of a sequential command which forces the next command to wait until the no-operation-pending flag is true. This is essentially the same as waiting for the OPC flag to become true, because the no-operations-pending flag is used to set the OPC flag (bit 0 of the Standard Event Status Register).

In normal operation, the overlapped commands execute faster than would appear by querying the OPC flag. This is due to the nature of the non-volatile memory storage process. Commands which change the status of the instrument limits, or change its mode or current range, step value, or status enable registers, will not have their OPC flag set until all current writing to non-volatile memory has been completed. This is done to ensure that the OPC flag is never set prematurely. However, in most cases, the individual operation will be completed immediately.

The speed of writing to non-volatile memory (NVRAM) is slow compared to processor speed, and the new information (to be written) is placed on a queue to reduce the processor overhead for non-volatile storage operations. However, the new information (i.e. new parameter value) is buffered and is essentially stored as soon as the command which created it is parsed. Therefore, even though the OPC flag may not be set immediately after a new parameter value is created, the new value is stored for all intents and purposes, and command throughput is not directly related to the OPC rate.

Whenever there is any output (response) data in the Output Queue, bit 4 is set in the Status Byte Register. Whenever there is any error message in the Error Queue, bit 7 is set in the Status Byte Register.

Output Off Register

The Output Off Enable Register allows the user to determine which conditions and events in the controller will cause the laser drive current OUTPUT to be turned off. This register is configured in a manner which is similar to the status reporting register. However, its output is not reported in the Status Byte Register. Rather, it goes to the hardware which controls the output switching. The events and conditions which may be set to cause the laser drive current OUTPUT to be turned off are shown in Figures 4.13.

The default (factory) setting for this register is 0, Current Limit does not shut the OUTPUT off. This setting is not effected by the *PSC (Power-On Status Clear) command.

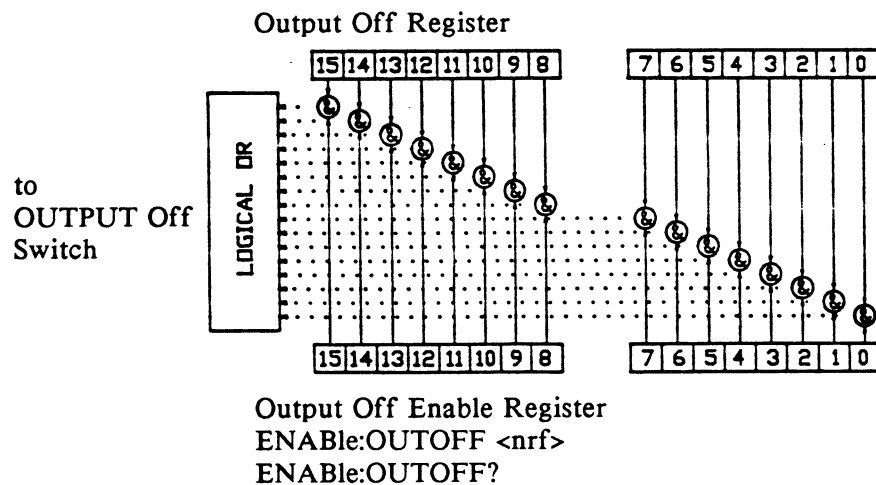

Bit Reference-

0- Current Limit
(bits 1 - 15 are N/A)

Figure 4.13 3811 Output Off Register

Input Buffer and Output Data

The Input buffer of the 3811 is 80 bytes. However, the user's <PROGRAM MESSAGE> may be longer.

The output (response) data of the 3811 is sent in blocks of up to 80 bytes in length. It is sent using high speed DMA within the 3811, but may be of indefinite

length. Although some commands have a definite length response, such as the MESSage? query, the response length is indefinite because the 3811 will respond to multiple queries in a single response output. The user may enter as many queries as desired in a single input message, and the 3811 will respond to all of them in the same output message, if possible. For example, the user may enter the following command:

```
"Mes?; Rad?; LDI?; Err?"
```

The response may appear in this manner:

```
"TEST1      ,DEC,25.0,0"
```

All query responses are evaluated at the time the query is parsed, and not at the time the response message is sent. In most cases this does not create a problem since the time between parsing a query and sending its response is small, unless the GPIB controller takes a long time to request the response.

Remote Interface Messages

The following sections are intended as a reference for using the 3811 with the GPIB option when an understanding of the lower level interface messages is required. These sections deal with the remote interface messages which are available with the 3811, and they contain a list of the Interface Function subsets. This information is generally not required by the user unless there is a question of compatibility of the 3811 with a specific controller. A list of interface messages which are not supported by the 3811 is shown in Section 4.10.3. These messages will be ignored by the 3811.

The interface messages listed in this chapter are handled by the 9914 GPIB interface IC and the 80C188 processor in the 3811, and are transparent to the higher level commands. However, they may be explicitly used in some GPIB programs. A list of the 3811's allowable interface messages is shown in Section 4.10.2.

Interface Function Subsets

Table 4.2 contains the remote Interface Function Subsets which are supported by the 3811. For more information, see the ANSI/IEEE-488.1-1987 standard.

Table 4.2 3811 Interface Function Subsets

SH1	Source Handshake - complete compatibility
AH1	Acceptor Handshake - complete capability
T6	Talker Functions
L4	Listener Functions
SR1	Service Request - complete capability
RL1	Remote Local Function - complete capability
PP0	Remote Configuration Parallel Poll - no capability
DC1	Device Dlear - complete capability
DT0	Device Trigger - no capability
C0	Controller Function - no capability
E1, E2	Three-state bus drivers with automatic switch to open collector during Parallel Poll

3811 Remote Messages

The following list contains GPIB remote messages which are compatible with the 3811 GPIB driver.

Table 4.3 3811 Allowable GPIB Interface Messages

ACG	GTL	OTA	PPR3	REN	SRQ
ATN	IDY	PCG	PPR4	RFD	STB
DAB	IFC	PPC	PPR5	RQS	TAG
DAC	LAG	PPE	PPR6	SCG	UCG
DAV	LLO	PPD	PPR7	SDC	UNL
DCL	MLA	PPR1	PPR8	SPD	UNT
END	MTA	PPR2	PPU	SPE	

Non-Supported Remote Interface Messages

Table 4.4 contains GPIB interface messages which are known to be incompatible with the 3811. Other interface messages which do not appear in Section 4.10.2 may also be incompatible with the 3811.

Table 4.4 Non-Supported Interface Messages for the 3811

EOS	MSA	NUL
GET	OSA	TCT

MAINTENANCE

This chapter describes how to maintain the LDP-3811. Included are sections covering calibration, fuse replacement, line voltage selection and disassembly.

**WARNING**

The service procedures described in this chapter are for use by qualified personnel. Potentially lethal voltages exist within the LDP-3811. To avoid electric shock, do not perform any of the procedures described in this chapter unless you are qualified to do so.

Qualified service personnel are required to wear protective eyeglasses and anti-static wrist bands while working on the LDP-3811 circuit boards.

**CAUTION**

High voltages are present on and around the printed circuit boards of the LDP-3811

Calibration Overview

The LDP-3811 should be calibrated every 12 months or whenever performance verification indicates that calibration is necessary.

All calibrations can be done with the case closed. The instrument is calibrated by changing the internally stored digital calibration constants.

Recommended Equipment

Recommended test equipment for calibrating the 3811 is listed in Table 5.1. Equipment other than that shown in the table may be used if the specifications meet or exceed those listed. If your 3811 is equipped with the model 1231 GPIB/IEEE-488.2 interface refer to Section 5.4 for calibration procedures using the GPIB.

Table 5.1 Recommended Test Equipment

Description	Mfg./Model	Specification
DMM	Fluke 8840A	DC Amps (@ 1.0A): +1% Resistance (@ 10 ohms): 0.02%
Resistor		50 Ohm, 15 W

Environmental Conditions

Calibrate this instrument under laboratory conditions. We recommend calibration at $23^{\circ}\text{C} \pm 1.0^{\circ}\text{C}$. When necessary, however, the LDP-3811 may be calibrated at its intended use temperature if this is within the specified operating temperature range of 0 to 50°C .

Warm-Up

The LDP-3811 should be allowed to warm up for at least 1 hour before calibration.

Cleaning



WARNING

Before cleaning the LDP-3811, the AC power cord must be disconnected from the instrument.

The LDP-3811 should be wiped off with a dry, lint-free cloth. Do not use an acetone or alcohol solution which can cause damage to the enclosure.

Local Operation Current Source Calibration

The following procedure is for calibrating the 200 and 500 mA current source ranges. This procedure is for local (front panel) operation. See Section 5.4 for remote calibration of the current source ranges. The 3811 uses a 2-point calibration procedure.

- a Connect the 3811 to the appropriate AC source. Turn the power on and allow the 3811 to warm up for at least one hour. Turn the KEYLOCK switch to the ENABLED position.
- b Set the laser drive current range as desired. For best results the appropriate current limit (LIM I200 or LIM I500) should be set to full scale (200 or 500 mA).

Note: The LIM I200 must be set greater than or equal to 33.1 mA and LIM I500 must be set greater than or equal to 82.6 mA for the calibration to work. If these conditions are not met, error #516 will be generated. Connect a precision ammeter (DMM) in series with a 50 ohm, 15 W resistor across the OUTPUT terminals.

- c Enter the calibration mode by pushing the (GPIB) LOCAL and (MODE) SELECT switches at the same time. The display will be blank for a few seconds, and then it will indicate the output current in mA. The output current will be set to 90% of the limit value.
- d Measure the OUTPUT current with the precision ammeter.
- e Press and hold in the SET switch and turn the ADJUST knob until the display indicates the same current as measured in Step d. Release the SET switch to store the new value into non-volatile memory.
- f After the SET switch is released, the 3811 will set the OUTPUT to a value of 30.0 or 75.0 mA (for 200 or 500 mA ranges, respectively). Repeat steps d and e for this lower calibration point. After the SET switch is released the 3811 will return to its former state, before calibration.
- g Repeat this procedure for the other current range.

If an error occurs during calibration, i.e. the interlock connections are opened, the 3811 will exit calibration mode without changing the calibration values. If this happens, fix the error and repeat the calibration procedure.

Remote Operation Current Source Calibration

The following procedure is for calibrating the 200 and 500 mA constant current source ranges via remote (GPIB) operation. See Section 5.3 for local calibration of the current source ranges. The 3811 uses a 2-point calibration procedure.

- a Connect the 3811 to the appropriate AC source. Turn the power on and allow the 3811 to warm up for at least one hour. Turn the KEYLOCK switch to the ENABLED position.
- b Set the current range as desired via the "RAN" command. Connect a precision ammeter (DMM) in series with a 50 ohm, 15 W resistor across the OUTPUT terminals. For best results set the appropriate current limit (LIM I200 or LIM I500) to full scale (200 or 500 mA) via the "LIM:I200 200" or "LIM:I500 500" command.

Note: The LIM:I200 must be set greater than or equal to 33.1 mA and LIM:I500 must be set greater than or equal to 82.6 mA for the calibration to work. If these conditions are not met, error #516 will be generated.

- c Enter the calibration mode by issuing the "CAL:LDI" command.
- d After a 5 second delay, issue the "CAL:LDI?" query. If the 3811 returns "1", it is ready to continue the calibration procedure. If the 3811 returns "0", it is not ready. In that case repeat step d until a "1" is returned.

The "DELAY 5000" command may be used to create the delay. The delay is needed to allow for the CDRH required OUTPUT on delay. The OUTPUT current does not flow until 2 seconds after the OUTPUT is turned on, for safety reasons. An additional 0.5 seconds is required for the slow-start circuit of the 3811 to stabilize the OUTPUT current to the set point.

If the 3811 returns "0" after the "CAL:LDI?" query, it is recommended that the user check for errors by issuing the "ERR?" query. If any errors have occurred during the calibration process, the 3811 will abort the calibration process. Therefore, any response other than "0" to the "ERR?" query should be handled before continuing restarting the calibration procedure.

- e With the DMM set up (as outlined in step b) input the measured OUTPUT current (as an <nrf value>, in mA) via the "LDI <nrf value>" command.

The measured value of the current should not be entered until the 3811 is ready to receive it.

The 3811 will be ready to receive the current value when, after a "CAL:LDI?" query is sent, the response from the 3811 is "1".

After the "LDI" value is entered, the "*OPC?" query may be used to determine when the calibration sequence is done. However, the "*OPC", or "*WAI" command, or "*OPC?" query should not be issued until after the expected "LDI" value is entered, or the system will "hang". This happens because the 3811 will wait indefinitely for an input, yet not allow any input until the calibration is finished.

- f Once the actual current value is entered via the "LDI" command, the new calibration value will be stored into non-volatile memory. The "OPC?" query may be used (after the "LDI" value is sent) to determine when the calibration is completed.

The operation complete flag (bit 0 of the Standard Event Status Register) may be used to trigger an interrupt. This type of interrupt is enabled by setting bit 0 of the Service Request Enable Register and using the *OPC command.

- g** Repeat steps e and f for the lower calibration value (a 2-point calibration is done). After the lower calibration point value is entered via the "LDI" command, the 3811 will return to the state it was in prior to calibration.
- h** Repeat this procedure for the other current output range.

If an error occurs during calibration, i.e. the interlock connections are opened, the 3811 will exit calibration mode without changing the calibration values. Error events may be retrieved via the "ERR?" query, as explained in Step d. If an error happens during calibration, fix the error and repeat the calibration procedure.

Fuse Replacement

The fuses are accessible from the back panel of the 3811 below the power entry module. Before replacing the fuses, turn power off and disconnect the line cord. Use only the fuses indicated below in Table 5.2.

Table 5.2 Fuse Replacement

Line Voltage	Fuse Replacement
100 / 120 VAC	1A, 250V, T
220-230 / 240 VAC	0.5A, 250V, T

TROUBLESHOOTING



This chapter is intended to be used as a guide when the LDP-3811 does not perform as expected. It is not a service manual, but rather a guide to alleviating basic problems which may arise during LDP-3811 operation.

If you have difficulty while operating the LDP-3811, refer to the symptoms listed here. Some of the common causes and corrective actions for these symptoms are listed in this section.

SYMPTOMS	CAUSES and CORRECTIVE ACTIONS
LDP-3811 will not power up	Check the power cord to make sure that it is properly connected. Check the fuse for integrity and proper rating.
OUTPUT does not stay on	<p>Check the display for error messages when the (OUTPUT) ON switch is pressed “on”.</p> <ul style="list-style-type: none"> • “E501” indicates an open interlock (pins 1 and 2 of the 9-pin, d-sub OUTPUT connector must be shorted together). • “E522” indicates a disabled KEYLOCK switch. • “D530” indicates that the laser drive current (OUTPUT) connections were open or that a voltage limit condition occurred while the OUTPUT was on. In order to clear the “E530” message from the display, the user must first correct the problem, then turn the OUTPUT back on. A voltage limit condition may be the result of attempting to drive a relatively high current through a relatively high impedance load. <p>For example, attempting to drive 500 mA through a 100 ohm load requires a compliance voltage of 50 volts. The LDP-3811 is specified to have a compliance voltage of just greater than 25 volts. Thus, the voltage limit condition would probably exist.</p> <ul style="list-style-type: none"> • If GPIB (remote) operation is used, the user should be aware that the conditions which force the OUTPUT off may be changed by the user via the “ENAB:OUTOFF” command. If this command is issued, the current limit (LIM) condition may cause the OUTPUT to be turned off.
Duty Cycle set point is not constant	The LDP-3811 may force the Duty Cycle (CDC) set point to change to a valid value when and if the Pulse Width (PW) is changed. This is necessary because the resolution of the “on” and “off” times of the pulse cycle dictate the resulting duty cycle. A resolution of 0.1 uSec for PW and PRI is the limiting factor. Adjusting the Pulse Width (PW) first, then edit the Duty Cycle (CDC). When editing PW (in CDC mode), it may be necessary to check the CDC set point to see if it has changed. Then, if it has changed, adjust the PW and reset CDC, as necessary.

Duty Cycle does not show all possible values	The LDP-3811 automatically adjusts the display to show only valid duty cycle (CDC) values, based on the present Pulse Width (PW). This is necessary because the resolution of the “on” and “off” times of the pulse cycle dictate the resulting duty cycle. A resolution of 0.1 uSec for PW and PRI is the limiting factor. Adjust the Pulse Width (PW) first, then edit the Duty Cycle (CDC).
Setting Duty Cycle remotely gets wrong results	This may happen because the resolution of the “on” and “off” times of the pulse cycle dictate the resulting duty cycle. A resolution of 0.1 uSec for PW and PRI is the limiting factor. Therefore, if a value for Duty Cycle (CDC) is entered which is not valid (given the present pulse width), the LDP-3811 will automatically adjust the CDC set point to the nearest valid value. Therefore, it is recommended that the user query the CDC set point via the “SET:CDC?” query after issuing the “CDC” command. This allows the user to determine if some adjustment is required.
Calibration does not begin	If the error message “E516” is displayed (or returned remotely via the “ERR?” query), it indicates that the laser drive current limit (LIM) is set too low for the present range. It is recommended that the laser drive current limits be set to full scale for the respective output range for calibration.
Error light flashing but no apparent error	<p>Error messages are only displayed for three seconds. After that the error light will remain flashing until the error is corrected. In the case of a voltage limit / open circuit error, the error light will remain flashing until the error is corrected and the OUTPUT is again turned on. This is done because the act of turning the OUTPUT off would otherwise remove that error condition.</p> <p>If the error light flashes and the message is missed, and turning the OUTPUT on does not restore the error message, it means that there was an intermittent voltage limit / open circuit condition.</p>
OUTPUT is turned off, but no apparent error	<p>An error condition occurred which turned the OUTPUT off, but the error was corrected before the user read the message.</p> <p>This most likely is caused by an intermittent open in the interlock connection.</p>

ERROR MESSAGES



Error messages may appear on the LDP-3811 display when error conditions occur. In remote operation, the current error list can be read by issuing the “ERR?” query. When this is done, a string will be returned containing all of the error messages which are currently in the error message queue.

Table A.2 contains all of the error messages which may be generated by the LDP-3811. Not all of these messages may appear on the front panel display. Some refer to GPIB activities only, for example.

The errors codes are numerically divided into areas of operation. Errors which pertain to the following areas are listed in the ranges shown in Table A.1.

Table A.1 Error Code Classifications

Error Code Range	Area of Operation
E-001 to E-099	Internal Program Errors
E-100 to E-199	Parser Errors
E-200 to E-299	Execution Control Errors
E300 to E-399	GPIB Errors
E-400 to E-499	N/A
E-500 to E-599	Laser Controller Errors
E-700 to E-999	Hardware Errors

Table A.2 Error Message Codes

Error Code	Explanation
E-001	Memory allocation failure
E-101	<program mnemonic> is too long
E-102	<PROGRAM MESSAGE UNIT> is too long
E-103	<DEFINITE LENGTH ARBITRARY BLOCK PROGRAM DATA> length too long
E-104	<NON-DECIMAL NUMERIC PROGRAM DATA> type not defined
E-105	<DECIMAL PROGRAM DATA> exponent not valid
E-106	<DECIMAL PROGRAM DATA> digit expected
E-107	<DECIMAL PROGRAM DATA> digit not expected
E-108	<DECIMAL PROGRAM DATA> more than one decimal point
E-109	<DECIMAL PROGRAM DATA> more than one exponential indicator (E)
E-110	<SUFFIX PROGRAM DATA> must have digit following sign
E-111	<SUFFIX PROGRAM DATA> must have alpha character following operator
E-113	<ARBITRARY BLOCK PROGRAM DATA> length less than digit count
E-114	<DEFINITE LENGTH BLOCK PROGRAM DATA> premature end of data
E-115	<PLACEHOLDER PROGRAM DATA> identifier not valid
E-116	Parser syntax error, character was not expected
E-120	<program mnemonic> Lookup, word as part of a header path, has no commands
E-121	<program mnemonic> Lookup, word as part of a header path, is not found
E-122	<program mnemonic> Lookup, cannot find a null entry
E-123	<program mnemonic> Lookup, word with context of current path, is not found
E-124	<program mnemonic> Lookup, failed because query / command type match failed
E-125	<program mnemonic> Lookup, word within context of common command path is not found
E-126	Too few or too many program data elements
E-201	<PROGRAM DATA> value out of range
E-202	<PROGRAM DATA> will not convert to valid type
E-203	Security violation, command is not available without clearance
E-204	<PROGRAM DATA> suffix type is not valid
E-205	<PROGRAM DATA> is not a boolean value or word
E-206	<PROGRAM DATA> will not convert to a signed 16-bit value
E-207	<PROGRAM DATA> will not convert to an unsigned 16-bit value
E-208	<PROGRAM DATA> will not convert to a signed 32-bit value
E-209	<PROGRAM DATA> will not convert to an unsigned 32-bit value
E-210	<PROGRAM DATA> will not convert to a floating point value

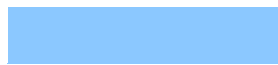

Error Code	Explanation
E-211	<PROGRAM DATA> will not convert to a character value
E-212	<PROGRAM DATA> will not convert to a byte array pointer
E-213	<PROGRAM DATA> is incorrect block data length
E-214	<PROGRAM DATA> length exceeds maximum
E-301A	<RESPONSE MESSAGE> was ready, but controller failed to read it (Query error)
E-501	Interlock disabled output
E-504	Current limit disabled output
E-511	Control error disabled output
E-512	Analog section status is all 1's or all 0's (power down)
E-516	Incorrect configuration for calibration sequence to start
E-522	KEYLOCK disabled output
E-530	Voltage limit / Open circuit disabled output
E-706	Auto-calibration cycle aborted
E-720 to E-975	Invalid internal status reporting error

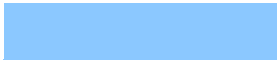

QUICK START**Installation**

Check to be sure that the voltage printed on the back panel of the instrument matches the power-line voltage in your area. Connect the 3811 to the proper AC power receptacle and turn the back panel KEYLOCK switch to the "ENABLED" position and turn the front panel POWER switch "on" (LED lit).

**WARNING**

To avoid electrical shock hazard, connect the instrument to properly earth-grounded, 3-prong receptacles only. Failure to observe this precaution can result in severe injury or death.

Setup the OUTPUT Parameters

Press the SELECT switch (in the PARAMETER SETUP section) once or twice to view the LIM 200 or LIM 500 limit (select the limit for the output range you plan to use). Then, press and hold in the SET switch and turn the adjust knob to select a limit value which is compatible with the laser (or other device) you are using. When the SET switch is released, the new limit value will be stored, and the instrument state will change to the indicated range.

If you wish to use the 500 mA output range, press the (PARAMETER SETUP) SELECT switch again until the 200 mA RANGE LED flashes. Then, press the SET switch and turn the adjust knob to change ranges. The selected range value will be shown on the digital display. When the SET switch is released, the new range will be stored and the 3811 will change to the selected range. After the output range and limit are stored, turn the front panel ADJUST knob to change the set point (operating) current. Three seconds after turning the ADJUST knob, the display will return to showing the measured current.

Initialize Test Mode Parameters

CONST % (Constant Duty Cycle) is the default mode. CONST % mode allows the user to adjust the pulse width (PW) while maintaining a constant duty cycle percentage. CONST PRI (Constant Pulse Repetition Interval) mode allows the user to adjust the pulse width while maintaining a constant pulse period. CW (Continuous Wave) mode disables pulsing.

If you wish to change modes press the (MODE) SELECT switch. To switch between Continuous Wave (CW) mode and any PULSE mode, hold the (MODE) SELECT switch in until the present mode LED starts to flash. Release the switch, and the MODE will change. To toggle around the PULSE modes, press the (MODE) SELECT switch momentarily.

In any PULSE mode, the Pulse Width is set by pressing the PW switch and then turning the adjust knob. Pulse width (and PRI, in CONST PRI mode) will be displayed in either uSec or mSec, using the appropriate unit enunciator.

In CONST % mode, set the duty cycle by pressing the DUTY CYCLE % / PRI switch and then turning the front panel adjust knob. Valid duty cycles are automatically determined by the PW selected (and are based on the resolution of the 3811 pulse circuit on/off times).

In CONST PRI mode, set the PRI by pressing the DUTY CYCLE % / PRI switch and then turning the front panel adjust knob.

External Trigger (EXT) mode operation is discussed in Chapter 2, Operation.

Connect to the Laser

Connect the laser (or other device) to the back panel BNC connector or 9-pin, D-Sub OUTPUT connector. Be sure that the device is connected properly, with the polarity as shown on the 3811 back panel, or refer the pin-out for the 9-pin connector.

Note: The interlock (pins 1 and 2 on the 9-pin, D-Sub OUTPUT connector) MUST be connected or the OUTPUT will not be enabled.

Turn the OUTPUT on by pressing the ON switch. After a 2 second delay, the 3811 will automatically drive the laser to the set point current (waveform, etc.).

While the OUTPUT is on, the laser drive current OUTPUT set point and limit may be changed. Also, the pulse duration may be edited (if in a PULSE mode). If the pulse width is changed, the duty cycle percentage may be automatically altered, if required (due to the limitations of the resolution of the PW and PRI values).

If the mode of operation is changed, the OUTPUT will be forced off.

Saving Changes

When the 3811 is powered off, the state of the unit at power-down is saved in non-volatile memory. For information on saving additional setups, see Chapter 2.

More Information

The user should read Chapter 2, Operation, to become familiar with all of the features of the LDP-3811. Section 2.4.1 is useful for a quick familiarization of the LDP-3811 front panel. Remote operation is discussed in Chapters 3 and 4 of this manual.

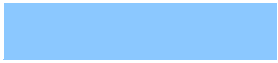

Installation