

**Epson® PowerLite® Pro Cinema 800
Home Theater Projector**

User's Guide

Copyright Notice

All rights reserved. No part of this publication may be reproduced, stored in a retrieval system, or transmitted in any form or by any means, electronic, mechanical, photocopying, recording, or otherwise, without the prior written permission of Seiko Epson Corporation. The information contained herein is designed only for use with this Epson product. Epson is not responsible for any use of this information as applied to other products.

Neither Seiko Epson Corporation nor its affiliates shall be liable to the purchaser of this product or third parties for damages, losses, costs, or expenses incurred by purchaser or third parties as a result of: accident, misuse, or abuse of this product or unauthorized modifications, repairs, or alterations to this product, or (excluding the U.S.) failure to strictly comply with Seiko Epson Corporation's operating and maintenance instructions.

Seiko Epson Corporation shall not be liable for any damages or problems arising from the use of any options or any consumable products other than those designated as Original Epson Products or Epson Approved Products by Seiko Epson Corporation.

Trademarks

Epson is a registered trademark and Exceed Your Vision is a trademark of Seiko Epson Corporation.

PrivateLine and PowerLite are registered trademarks, AccuCinema is a trademark, and Epson Extra Care and Epson Connection are service marks of Epson America, Inc.

HDMI, the HDMI logo, and High-Definition Multimedia Interface are trademarks or registered trademarks of HDMI Licensing, LLC.

Pixelworks is a trademark of Pixelworks, Inc.

General Notice: Other product names used herein are for identification purposes only and may be trademarks of their respective owners. Epson disclaims any and all rights in those marks.

Contents

Introduction	7
Projector Parts	8
Projector Control Panel	9
Remote Control Button Map	10
Optional Accessories	11
Registration and Warranty	11
Using This Manual	12
Setting Up the Projector	13
Choosing a Location	13
Installing the Projector	16
Connecting the Cables	18
Making Other Connections	19
Installing Batteries in the Remote Control	20
Turning On the Projector	21
Turning Off the Projector	22
Selecting the Image Source	22
Positioning the Image	24
Making Basic Adjustments	25
Correcting the Image Shape	25
Focusing and Zooming	26
Choosing the Aspect Ratio	26
Choosing the Color Mode	28
Adjusting the Gamma, Color Temperature, and Skin Tones	29
Adjusting the Gamma Setting	30
Locking the Projector	31

Making Detailed Adjustments	33
Using the Menu System	33
Changing How the Menus Display	34
Adjusting the Picture Quality	35
Input Brightness Settings	35
Sharpness and Picture Quality Settings	37
Color Settings	38
Adjustments Just for Computer Images	40
Selecting Memory Settings and Resetting the Projector	41
Selecting Memory Settings	41
Creating Memory Settings	41
Deleting Saved Memory Settings	42
Resetting the Projector	42
Customizing Projector Features	43
Image Sizing	43
Screen Options	44
Other Setup Options	45
Maintenance	47
Cleaning the Lens	47
Cleaning the Projector Case	48
Cleaning and Replacing the Air Filter	48
Replacing the Lamp	50
Resetting the Lamp Usage Timer	52
Checking the Projector Status	53
Storing the Projector	53
Transporting the Projector	54

Problem Solving	55
What To Do When the Lights Come On or Flash	55
Solving Picture Problems	56
Solving Remote Control Problems	60
Where To Get Help	60
Specifications	61
General	61
Lamp	61
Remote Control	61
Dimensions	62
Electrical	62
Environmental	62
Safety	62
Compatible Video Formats	63
ESC/VP21 Command Codes	65
Notices	67
Important Safety Information	67
Remote Control Information	68
FCC Compliance Statement	69
Declaration of Conformity	70
Epson America, Inc., Limited Warranty	71
Index	73

Introduction

The Epson® PowerLite® Pro Cinema 800 projector lets you enjoy theater-quality images in the relaxing environment of your own home. Designed especially for home cinema use, it offers these outstanding features:

- Native 720p (1280 × 720) resolution, 5000:1 dynamic contrast ratio, and up to 1600 lumens for incredibly rich, sharp images in any room lighting
- Dynamic Eye Iris system that constantly controls the lamp intensity based on the gamma and black/white levels of your projected content, for perfectly adjusted images all the way through your movies and game sessions
- Epson 3LCD technology for reliable picture quality, increased contrast ratio, uniform colors, and the deepest blacks available
- 10 bit color quality for unmatched color accuracy, with over a billion colors available
- Epson AccuCinema™ Color Management delivered by the built-in optical Cinema Filter blocks out excess light for an expanded, purer color range and sophisticated grayscale tracking
- HDMI™ (High Definition Multimedia Interface™) port for superior, uncompressed digital video
- True 16:9 wide-format projection
- ISF (Image Science Foundation) certified calibration
- Flexible setup configurations, including front projection and ceiling mounted, with vertical and horizontal offset lens shift
- Seven optimized color modes to quickly optimize viewing for different lighting environments and a vast array of fine custom color adjustments

Projector Parts

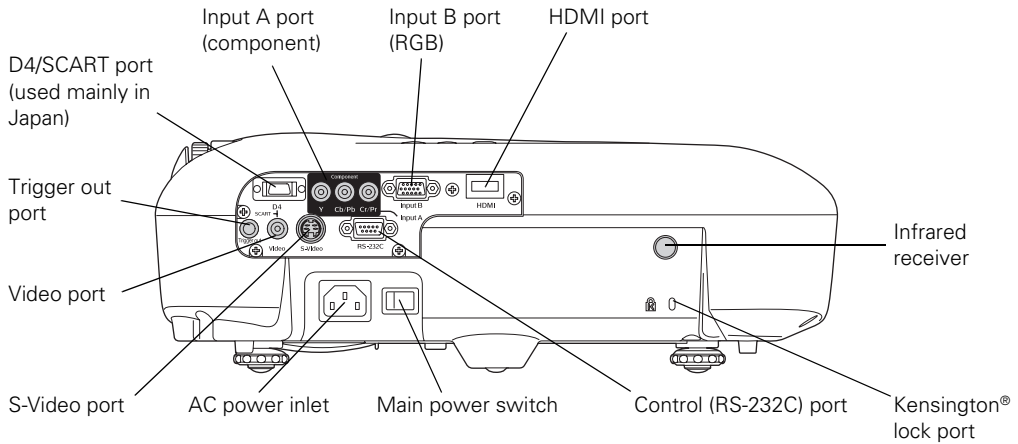
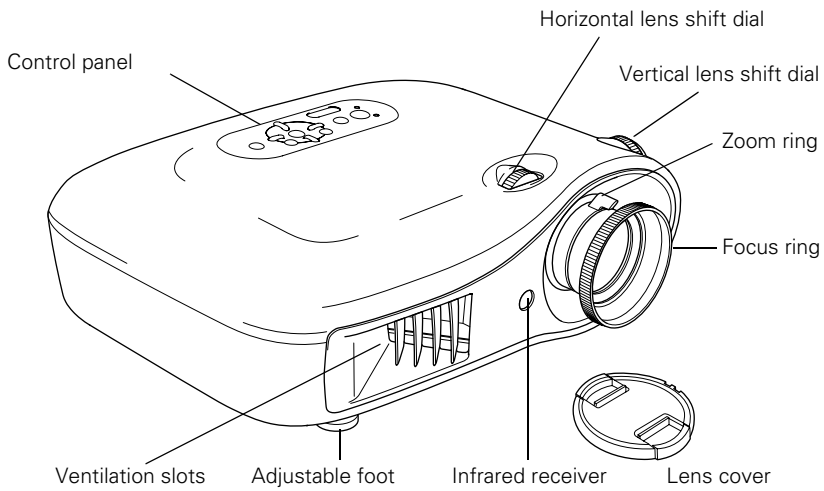

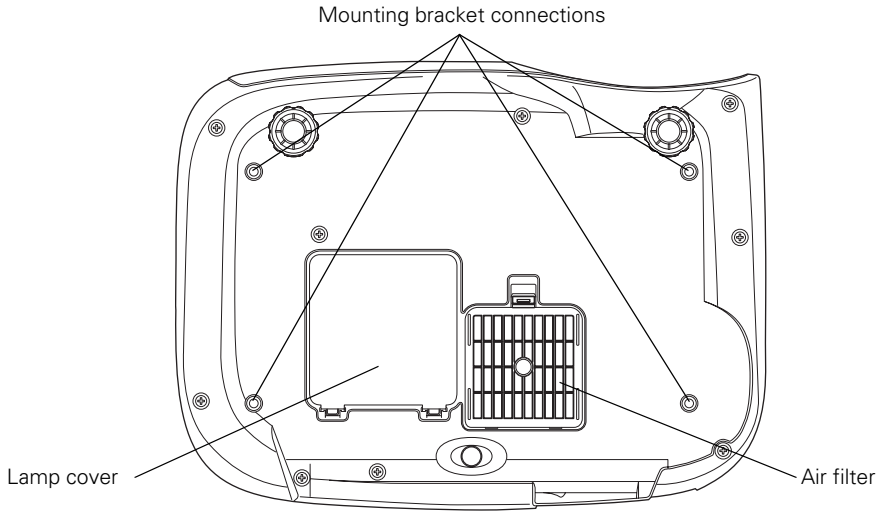

Projector Control Panel

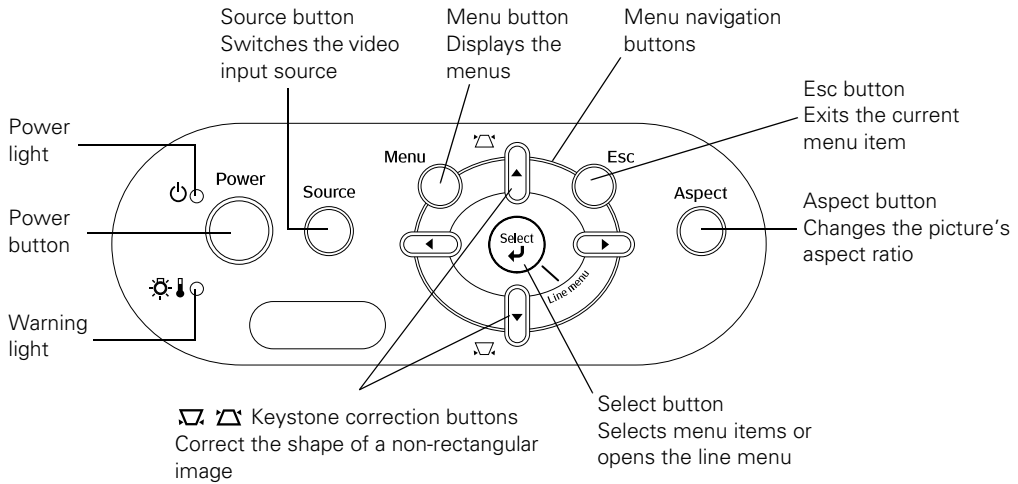

Remote Control Button Map

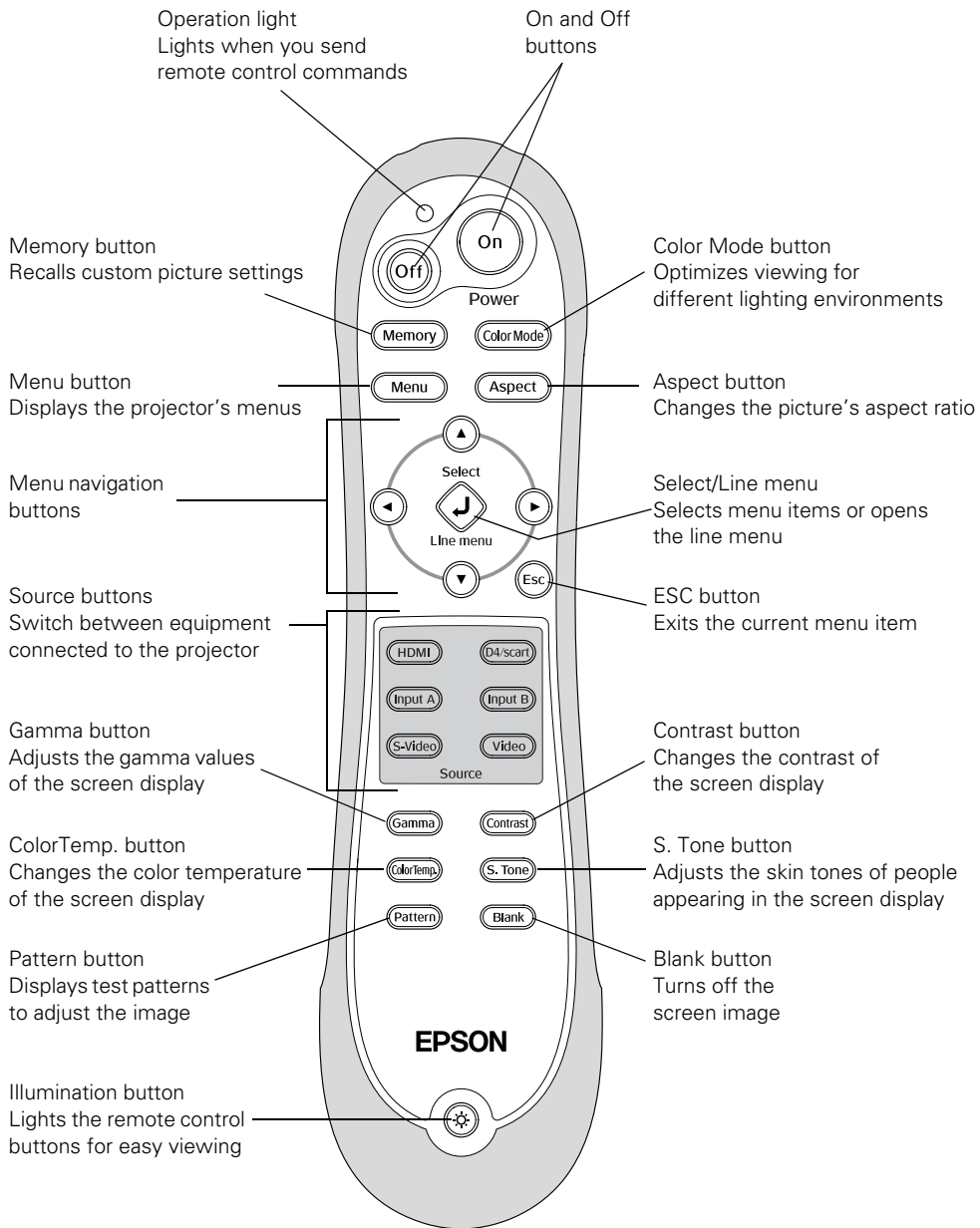

Optional Accessories

Epson provides the following optional accessories for the projector:

Product	Part number
Replacement lamp (ELPLP35)	V13H010L35
Air filter replacement (ELPAF09)	V13H134A09
Projector mount	ELPHB800
Kensington security lock	ELPSL01
S-video cable	ELPSV01

You can purchase accessories from an Epson authorized reseller. To find the nearest reseller, please call 800-GO-EPSON (800-463-7766). To purchase online, visit www.epsonstore.com (U.S. sales) or www.epson.ca (Canadian sales).

Registration and Warranty

The Epson PowerLite Pro Cinema 800 comes with a basic two-year carry-in warranty. For details, see page 71.

In addition, for customers who register their projector, Epson offers free Extra CareSM Home Service. In the unlikely event of an equipment failure, you won't have to wait for your unit to be repaired. Instead, Epson will ship you a replacement unit anywhere in the United States or Canada, usually via overnight delivery. See your *Extra Care Home Service* brochure for details.

To register, simply fill out the registration card that came with your projector and mail it to Epson. Or you can register online at <http://www.epson.com/webreg>. Registering also lets you receive special updates on new accessories, products, and service.

Using This Manual

This book contains all the information you need to use the projector, in addition to basic setup and maintenance instructions, troubleshooting tips, important safety instructions, specifications, and warranty information.

Please follow these guidelines as you read through the manual:

Warnings: Must be followed carefully to avoid bodily injury.

Cautions: Must be observed to avoid damage to your equipment.

Notes: Contain important information about your projector.

Tips: Contain helpful projection tips.

Need additional help? Take advantage of Epson's automated support services 24 hours a day at <http://support.epson.com>. Use this site to view FAQs (Frequently Asked Questions) or product information and e-mail your questions to Epson support.

If you need more help, you can use the Epson PrivateLine® Support service. Call (800) 637-7661 and enter the PIN on the PrivateLine support card that came with your projector.

Setting Up the Projector

Follow the instructions in this section to choose a location for the projector, connect the cables, and display an image.

Choosing a Location

You can install the projector for various viewing setups, as shown below.

Center

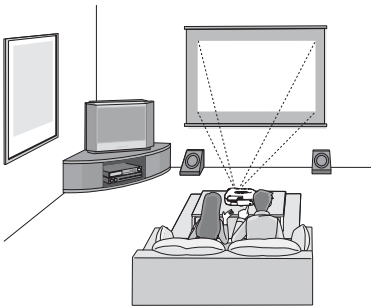

Side

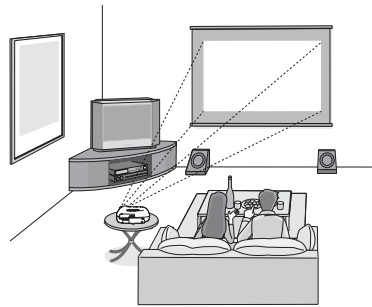

Ceiling

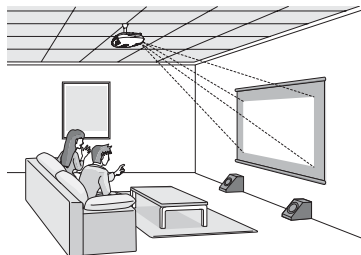

Ideally, place the projector at a height where its lens is between the top and bottom of the screen. That way, you can keep the projector level and use the vertical lens shift dial to position the image. This produces the best-looking picture.

If you place the projector above or below screen level, you'll have to tilt it up or down to aim the image at the screen; this distorts the shape of the image, but you can correct its shape using the projector's Keystone function (see page 25).

If you place the projector off to the side, aim it straight ahead (rather than at the center of the screen), then use the horizontal lens shift dial to center the image on the screen. Do not place the projector too far to the left or right, or your image won't be rectangular.

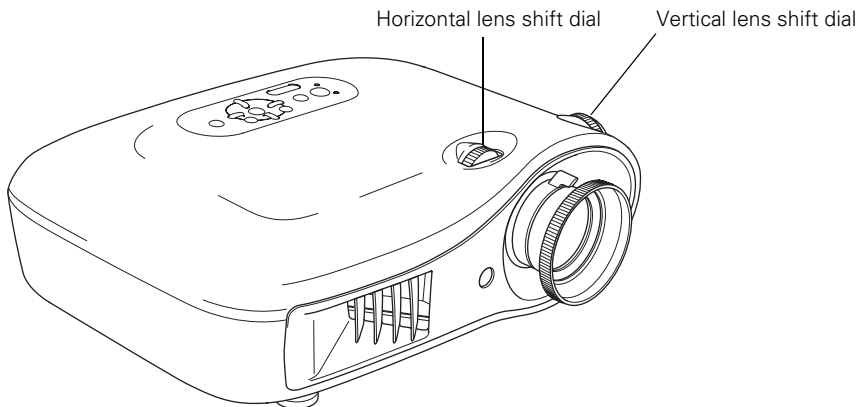
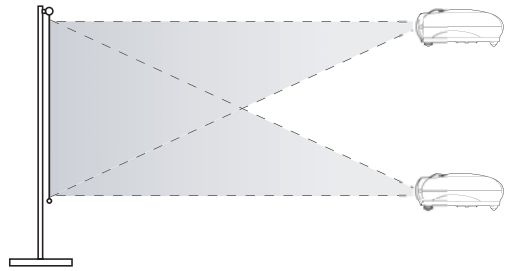

Caution: Do not try to move the lens by hand, or you may damage the projector. Always use the lens shift dials to change the lens position.

The maximum size of the image is determined by the distance from the projector's lens to the screen. Depending on your display settings and how you use the Zoom ring, the actual size may be smaller. Use this table as a rough guide for projector placement:

16:9 aspect ratio		4:3 aspect ratio	
Projection distance	Maximum diagonal image size	Projection distance	Maximum diagonal image size
2.9 to 4.4 feet	30 in. (26 × 15 in.)	3.5 to 5.3 feet	30 in. (24 × 18 in.)
3.9 to 5.9 feet	40 in. (35 × 20 in.)	4.8 to 7.2 feet	40 in. (32 × 24 in.)
5.9 to 8.9 feet	60 in. (51 × 28 in.)	7.2 to 10.8 feet	60 in. (47 × 35 in.)
7.9 to 11.8 feet	80 in. (71 × 39 in.)	9.7 to 14.5 feet	80 in. (63 × 47 in.)
9.9 to 14.8 feet	100 in. (87 × 47 in.)	12.1 to 18.2 feet	100 in. (79 × 59 in.)
20 to 29.8 feet	200 in. (173 × 98 in.)	24.5 to 36.5 feet	200 in. (161 × 118 in.)
30.1 to 44.8 feet	300 in. (260 × 146 in.)	36.8 to 54.8 feet	300 in. (240 × 181 in.)

To determine the exact image size when you know the projection distance (or the exact projection distance when you know the desired image size), you can use the Projection Distance Calculator. You can download this program from the Epson website at <http://support.epson.com>.

Also keep these considerations in mind:

- Make sure there is plenty of space for ventilation around and under the projector. Do not set the projector on top of loose materials that could block the vents underneath.
- Make sure the projector is within 9.8 feet of a grounded electrical outlet or extension cord.

Installing the Projector

To install the projector, you first need to determine the location, based on the size of your screen (maximum diagonal image size). Use the table on page 15 as a guide to locating the projector. Note the following dimensions:

- Distance from the center of the lens to the mounting bracket holes: 2.32 inches (59 mm), 0.34 inch (8.6 mm) maximum vertical lens shift
- Distance from the center of the lens to the center of the projector: 4.33 inches (110 mm), 0.30 inch (7.7 mm) maximum horizontal lens shift

The following illustrations show the dimensions of projector:

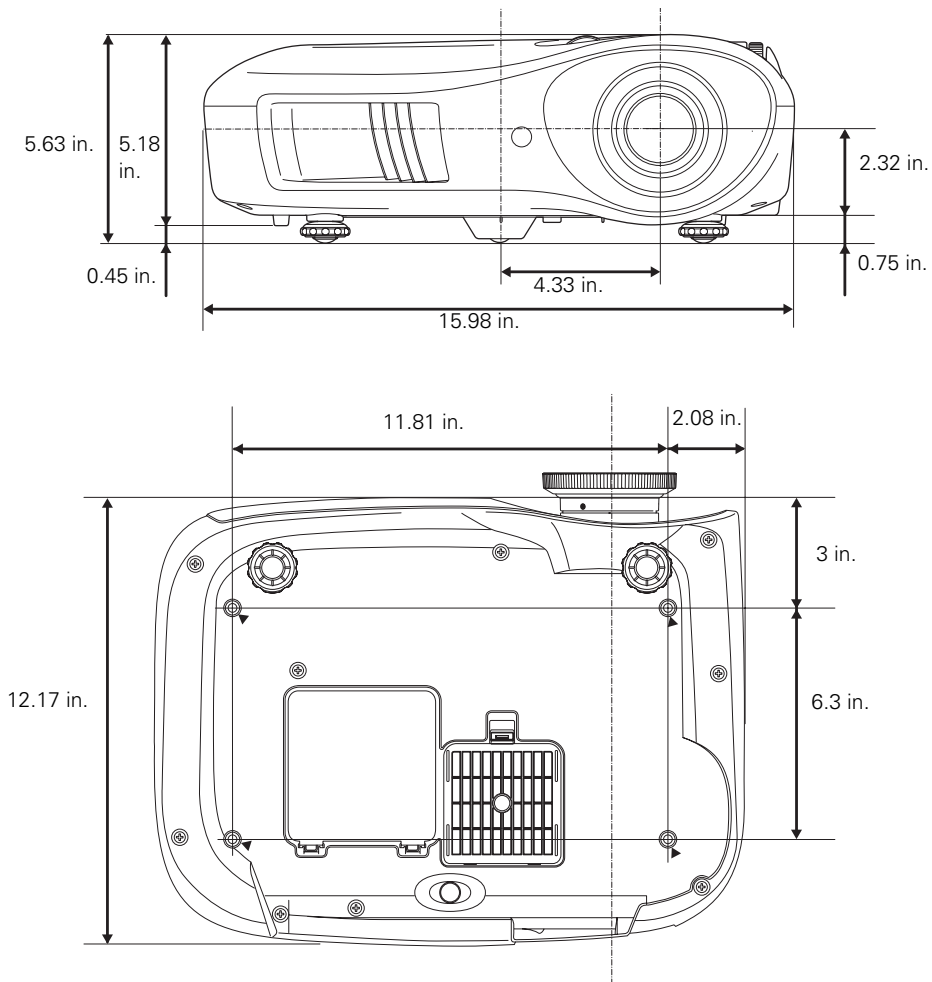

You will need the optional projector mount designed for the projector. See page 11 for ordering information.

Warning: When installing or adjusting the ceiling mount, do not use adhesives to prevent the screws from loosening and do not use any type of oil or lubricant. These may cause the projector casing to crack and the projector may fall, causing serious injury and serious damage to the projector.

Follow the instructions included with the mount to install the projector, which weighs 11.5 pounds. The wall or ceiling where you install it must be capable of supporting a weight of 58 pounds.

In addition to the tools supplied with the projector mount, you will need a Phillips head screwdriver and a drill to use on the wall or ceiling.

If you install the projector on the ceiling, you will need to invert the picture so that it appears right side up. Follow these steps:

1. Press the **Menu** button on the remote control.
2. Press the menu navigation buttons to open the **Settings** menu, then select **Projection**.
3. Use the navigation buttons to select **Front/Ceiling**.
4. Press the **Menu** button when done.



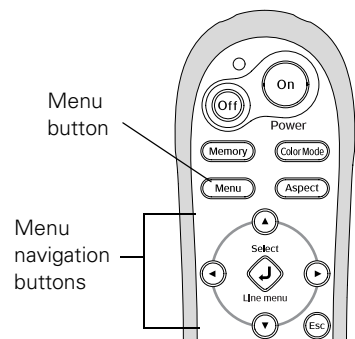





If you are planning to use an AV controller with the projector, refer to the table of ESC/VP21 command codes on page 65.

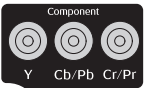

Connecting the Cables

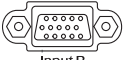
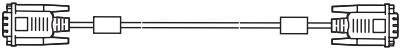
You can connect the projector to any type of video equipment, such as a VCR, DVD player, digital tuner, cable or satellite box, video game console, camcorder, or digital camera. You can also connect it to a desktop or laptop PC or Apple® Macintosh® system.

You can connect up to five pieces of video equipment at the same time, using any of the commercially available cables shown below:

Port name	Video equipment connection*	Computer connection*
HDMI 	Use an HDMI cable: 	
Input A  Component video ports	Use a component video cable (with RCA-style connectors):  Connect the cable to the three component video ports. Match corresponding colors between the cable and the ports.	—
Input B  Input B RGB port	—	Use a Mini D-sub, 15-pin monitor cable to connect to a computer RGB (monitor) port 
S-Video 	Use an S-video cable: 	—
Video 	Use an RCA video cable: 	—

* For details on compatible video formats, see page 63.

For best results, connect your video equipment to the HDMI (High-Definition Multimedia Interface) port, if possible. If your equipment doesn't support HDMI, connect it to one of the following ports (highest quality listed first): Input A (for component video), S-Video, or Video (for composite video).

Connect video equipment to one of these ports

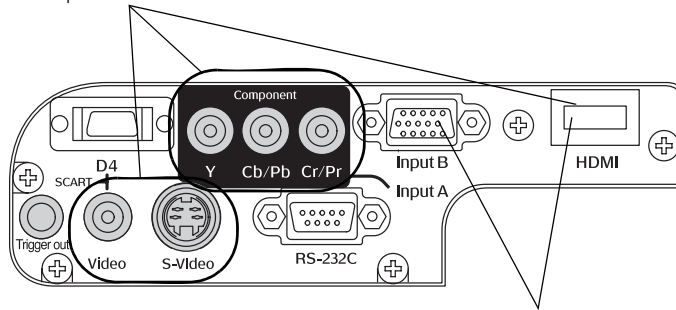

Connect a computer to one of these ports

If you connect to the Input A port, be sure to select the correct Input Signal setting for your equipment, or the image may not display properly (see page 22).

Making Other Connections

Connect the power cable and other cables described below, depending on how you plan to use the projector.

- Plug the power cable into the projector and a grounded electrical outlet.

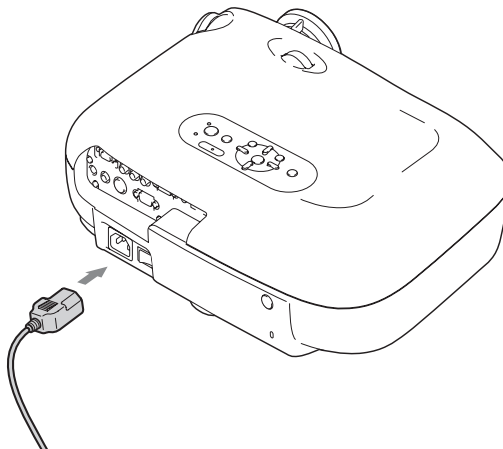

- The Trigger out port outputs a 12-volt DC signal when the projector is turned on. This lets a central control system monitor whether the projector is on or off, and can be used to raise or lower your projection screen automatically when the projector is in use.

Connect a 3.5-mm mini jack to the port, as shown.

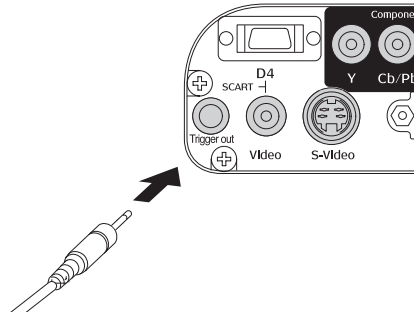

Installing Batteries in the Remote Control

The remote control uses 2 AA batteries.

Warning: Keep batteries away from children. If a battery is swallowed, contact your doctor immediately.

1. Release the tab and lift open the cover.

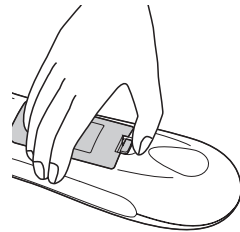

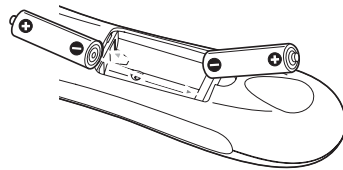

2. Insert 2 new AA batteries as shown.

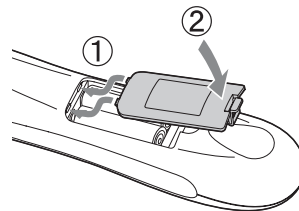

3. Insert the tab on the cover and press it down until it clicks into place.

Aim the remote control at the front or back of the projector. Make sure you are within 30 feet of the projector with the remote aimed within a 30° angle from the infrared receivers.



When you suspect the batteries are weak, take the remote control to a darkened room and press the  illumination button. If the buttons do not glow red, replace the batteries.

Turning On the Projector

1. If this is your first time using the projector, remove the protective lens pad.

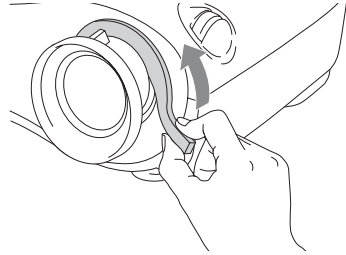

2. Remove the lens cap.
3. Turn on any connected equipment you plan to use.

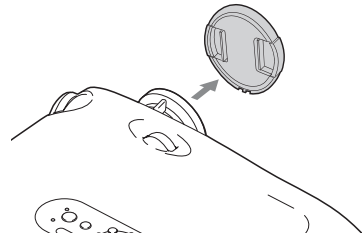

4. Turn on the power switch on the back of the projector.

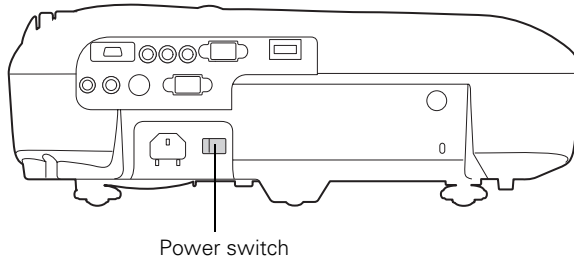

5. Press the **On** button on the remote control, or press the **Power** button on the projector.

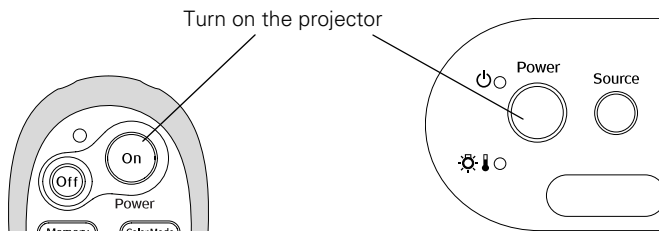

Note: To keep children from turning on the projector, you can use the Child Lock (see page 31).

If you'll be using the projector at an altitude above 4900 feet (1500 meters), turn on High Altitude Mode so the fan can properly cool the projector at the high altitude air pressure. See page 46 for details.

The projector takes about 30 seconds to warm up and display an image. If you don't see a picture, you may need to change the image source as described on the next page.

Turning Off the Projector

1. Turn off any equipment connected to the projector.
2. Press the **Off** button on the remote control, or press the **Power** button on the projector twice.
3. When the  power light stops flashing orange and stays on, turn off the projector's power switch on the back.

It is now safe to unplug the projector, if necessary.

Caution: Turn off this product when not in use to prolong the life of the projector. Continuous 24-hour-a-day use may reduce the overall life of the product. Never unplug the projector without turning it off and letting it cool as described above, or you could damage it and reduce lamp life.

Selecting the Image Source

The Source buttons on the projector and remote control let you switch between images from different pieces of equipment connected to the projector (such as a DVD player, cable or satellite box, or video game console).

Press the **Source** button on the remote control that corresponds to the port to which your video source is connected.

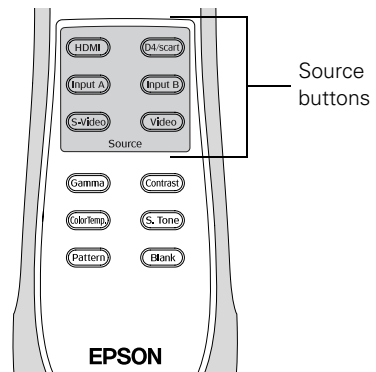

If you press the **Source** button on the projector, you see a menu of available sources.

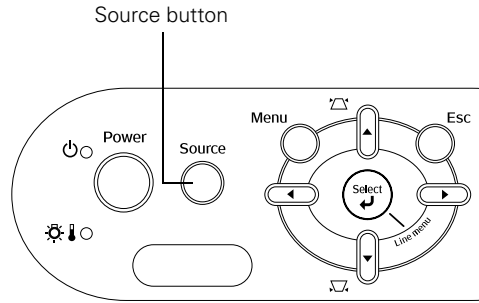

Press the ▲ or ▼ button to highlight a source and press the ↵ Select button.

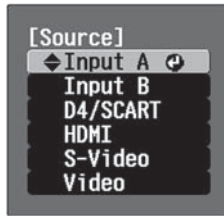

If you select the Input A source using either the remote control or the menu above, you may see the Input A menu:

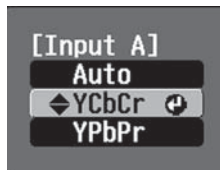

Press the ▲ or ▼ button to highlight YCbCr or YPbPr, or select **Auto** so the projector can automatically detect the Input A source type. Then press the **Select** button.

Note: If an image does not appear, check the troubleshooting tips on page 57.

To temporarily turn off the image and darken the screen, press the **Blank** button. Press the **Blank** button again to return to normal viewing.

Positioning the Image

If the image is not centered on the screen, use the horizontal and vertical lens shift dials to adjust its position.

Caution: Do not try to move the lens by hand, or you may damage the projector. Always use the lens shift dials to change the lens position.

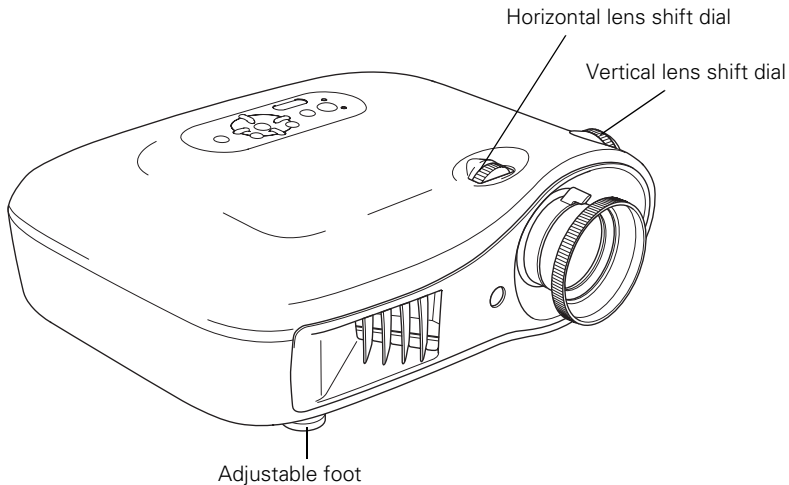

Note: You can display a test pattern to help adjust the image position. Press the **Pattern** button on the remote control, then select **Display Position**.



When you hear a click, the lens position is centered. If the lens shift dial becomes hard to turn, you cannot adjust the position any further.



If you still need to raise the height of the image after using the vertical lens shift dial, lift the front of the projector and rotate the adjustable feet until the image is positioned correctly.

Making Basic Adjustments

Follow the instructions in this chapter to make basic adjustments to the image shape, size, and color, and quality. For further refinements, see “Making Detailed Adjustments” on page 33.

Correcting the Image Shape

If the projected image looks like  or , use the Keystone function to correct its shape.

Note: If the image is shaped like  or , the projector has been placed off to the side of the screen and angled toward it. Face the projector straight ahead (instead of at the center of the screen), then use the horizontal lens shift dial to center the image.

To perform keystone correction, press the ▲ or ▼ button on the projector, or access the menu system as follows:

1. Press the **Menu** button on the remote control.
2. Press the menu navigation buttons to open the **Settings** menu, then select **Keystone**.
3. Press the ◀ or ▶ button to adjust the shape of the image.
4. Press the **Menu** button when done.

To reset the keystone correction to the original settings, press and hold down both the ▲ and ▼ buttons on the control panel for at least one second.

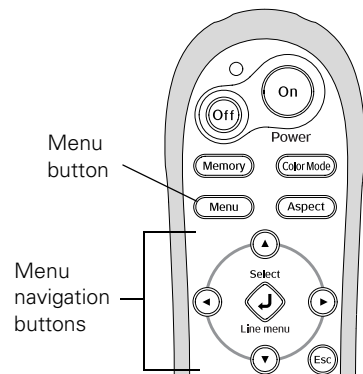

Focusing and Zooming

Sharpen or reduce the focus using the focus ring.

Zoom into or out of the picture using the zoom ring.

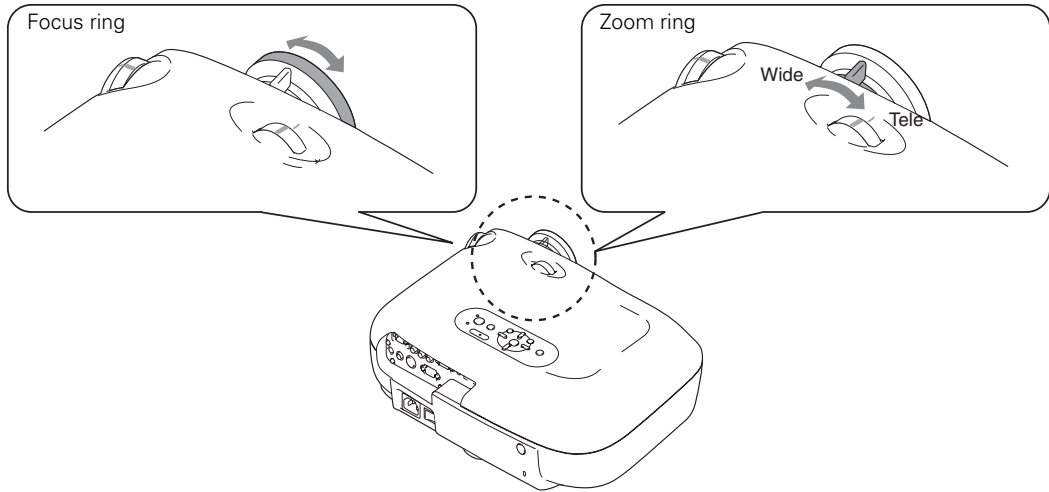

Choosing the Aspect Ratio

In many cases, video signals are automatically resized to fit on your screen when **Auto** is selected as the Aspect setting. You may need to change the size of the image (or aspect ratio) for certain image types by pressing the **Aspect** button on the remote control.

If your video source is connected to the HDMI, S-Video, or Video port—or the Input A port when it is outputting 525i or 525p signals—select **Auto** to automatically display your image in the correct size.

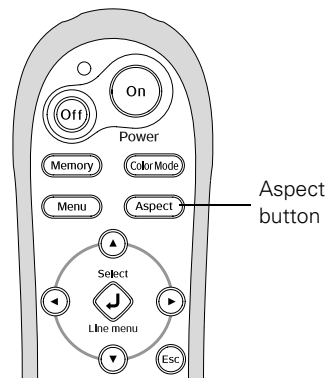

If the **Auto** setting is unavailable, you may want to choose one of these settings:

- **Normal** for standard TV broadcasts, computer images, or images with a 4:3 aspect ratio.
- **Zoom** for images recorded in 16:9 (wide-screen) format.

4:3 image using Normal setting



16:9 image using Zoom setting



- **Wide** if you want to expand a 4:3 image to 16:9 so it fills the whole screen. This stretches only the right and left sides of the image; the central part is unchanged. (You cannot select **Wide** when you're using keystone correction.)
- **Squeeze** for DVDs or video recordings made in a compressed 16:9 format called "Squeeze Mode."
- **Through** if your image is smaller than 1280 × 720 pixels and you want to display it at its original pixel size without resizing it to fit on the screen.
- **Squeeze Through** if your image is recorded in Squeeze Mode, is smaller than 1280 × 720 pixels, and you want to display it at its original pixel size.

Note: If you display a 4:3 image using the Zoom setting, the top and bottom will be cut off. You can use the Zoom Caption option and other settings to resize and reposition the image to your liking (see page 43).

For details on how the projector resizes the picture when you choose an Aspect setting, see page 63.

Choosing the Color Mode

You can change the Color Mode to automatically adjust brightness, contrast, and color, letting you quickly optimize the projected image for various lighting environments. You can also select a different color mode for each input source—which is useful if you view different types of images from different sources. (For example, you might set the S-Video source to **Cinema Day** if it's usually used for watching movies with the curtains closed, and set the Video source to **Vivid** for playing video games in the daytime with them open.)

Select the image source you want to adjust, then press the **Color Mode** button on the remote control. Choose from these settings:

- **Vivid** for projecting the brightest picture available.
- **Cinema Day** for watching movies during the day.
- **Natural** for projecting the most natural, accurate colors.
- **Cinema Night** for viewing movies in a dark room.
- **HD** for images that are close to those in professional-use broadcast monitors.
- **Silverscreen** for black and white movies or those with dark scenes.
- **Standard** for projecting computer images that conform to the sRGB color standard.

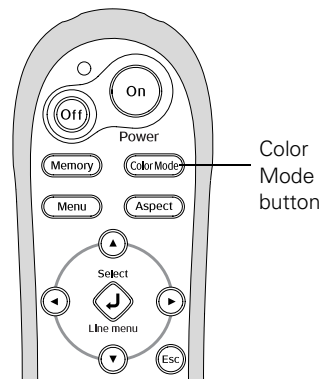

When you select the **Natural**, **Cinema Night**, or **Standard** Color Mode setting, the built-in Epson Cinema Filter automatically increases the contrast and naturalizes projected skin tones.

Adjusting the Gamma, Color Temperature, and Skin Tones

To further customize the color and image quality, you can adjust the Gamma, abstract Color Temperature, and Skin Tone settings using buttons on the remote control. (Not available when you're projecting sRGB images.)

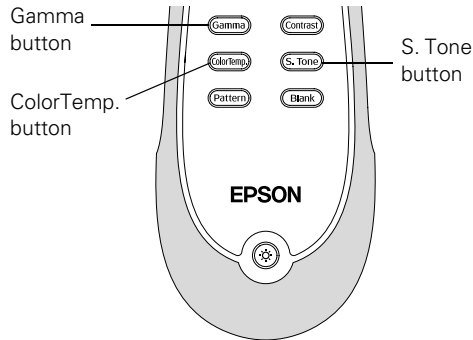

Note: You can fine-tune these and other color and image quality settings using the projector's menu system (see page 35). You can also save combinations of picture settings with the Memory feature for easy recall (see page 41).

Select the image source you want to adjust, then press any of the buttons described below. A slider appears beneath the image so you can adjust the setting and view the effect of your adjustments.

- **ColorTemp.** adjusts the overall color tint (absolute color temperature) between 5000K and 10000K. Higher temperature settings increase the blue tint and lower temperature settings increase the red tint.



- **S. Tone** adjusts the color of projected skin tones. The Epson Cinema Filter automatically optimizes this setting, but you can customize it if necessary. Higher numbered settings increase the green tones and lower numbered settings increase the red tones.



Adjusting the Gamma Setting

You can select from 5 gamma settings (2.0 to 2.4) or customize your own setting from your image or a displayed graph. Lower values will increase the contrast of dark areas, but tend to blur the bright areas. Higher values will darken the light areas.

1. Press the **Gamma** button. You see the following displayed on the screen:

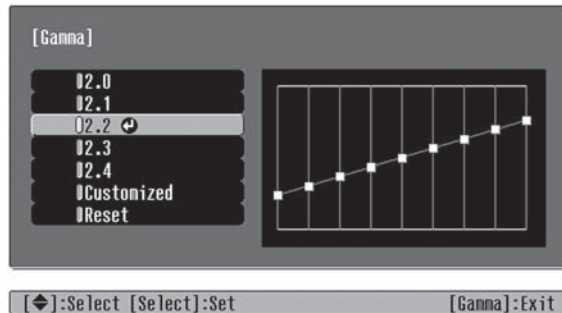

2. Do one of the following:

- Select one of the numeric correction values and press the **↵ Select** button. You see the setting reflected in the graph on the right. The horizontal axis represents the input signal level, and the vertical axis represents the output signal level.
- Select **Customized**. Then continue with the next step.

3. Do one of the following:

- Select **Adjusting it from the image**. You see a gamma icon on the projected image. Use the arrow buttons to move the icon to the area of brightness you want to adjust, then press **↵ Select**. When the gamma graph appears, press **↵ Select** again. You see the following slider for adjusting the setting:



Adjust the slider, then press **↵ Select**. If you need to go back and readjust the tone, press the **Esc** button.

- Select **Adjusting it from the graph**. When the gamma graph appears, use the arrow buttons to select the point on the graph that you want to adjust. Then press **↵ Select**. When the slider appears, adjust it as necessary, then press **↵ Select** again.

Locking the Projector

The projector includes two lock settings to prevent the image from being accidentally changed once it's adjusted, and to keep children from turning on the projector without adult supervision.

To access the lock settings, follow these steps:

1. Press the **Menu** button on the remote control.
2. Use the menu navigation buttons to open the **Settings** menu, then open the **Operation** menu.
3. Choose from these options:

- **Child Lock** to disable the **Power** button on the projector's control panel unless it is pressed for about 3 seconds. (You can use the **Power** button to turn it off, however.) Since you can still use the remote control to turn on the projector, you may want to keep it away from children's reach.
- **Operation Lock** to disable all the buttons on the projector's control panel. A lock icon appears on the screen whenever you press a button with Operation Lock turned on. To operate the projector, you must use the remote control. To cancel Operation Lock, press and hold the **Select** button on the projector's control panel for at least 7 seconds.

4. Press **Menu** to exit the menu system.

If you turned on the Operation Lock, the projector buttons are now locked.

If you turned on the Child Lock, turn off the projector and let it cool down. The Child Lock takes effect after the cool-down period.

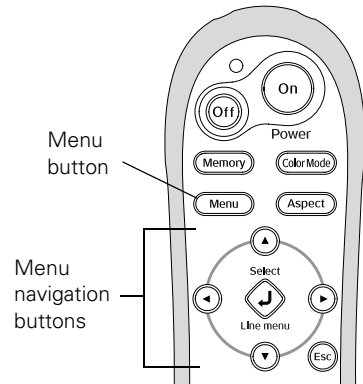

Making Detailed Adjustments

You can use the projector's on-screen menus to make detailed adjustments to the image quality—such as the brightness, contrast, sharpness, and color. You can also change the menu display, sleep mode settings, and other projector features.

Using the Menu System

You can access the menu system either from the remote control or the buttons on the projector's control panel. You can access the full menu or a line menu that lets you adjust the Picture and Memory settings while viewing their effects on your display. You can also change the menu language and control how the menus display (see page 34).

1. To display the full menu, press the **Menu** button on the projector or remote control. You see a display like this one (the actual display depends on the connected equipment):

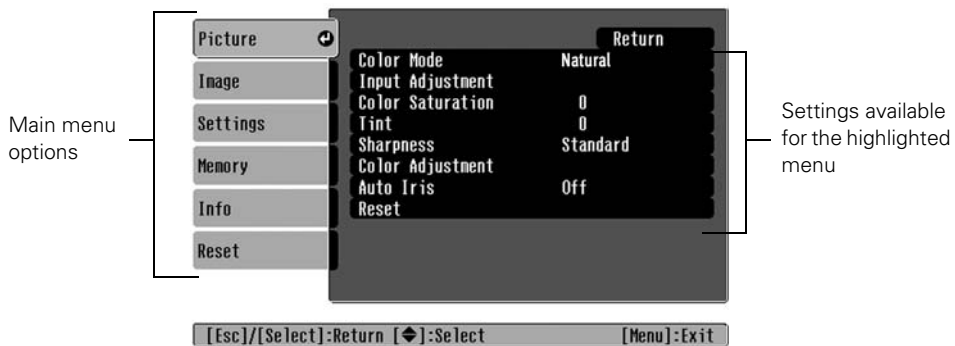

Note: If no equipment is connected to the projector, some options may not be available.

2. Press the **▲** or **▼** button to highlight an option, then press the **↵ Select** button to select it.
3. Press the **▲**, **▼**, **◀**, or **▶** button to change settings as necessary. You may have to press the **↵ Select** button to confirm your choice.
4. When you're finished, press the **Esc** button to return to the previous menu or press the **Menu** button to exit the menu system.

To display the line menu, press the **↵ Select** button. You see a display like this at the bottom of the image:



Press the **▲** or **▼** button to highlight an option, then press the **↵ Select** button to select it. Press the **Menu** button to exit the line menu.

You can access the following settings through the line menu while viewing their effects on your display:

- Sharpness (see page 37)
- Black Level (see page 36)
- White Level (see page 36)
- Skin Tone (see page 29)
- Absolute Color Temperature (see page 29)
- Tint (see page 38)
- Color Saturation (see page 38)

You can display a test pattern to help adjust the settings. Press the **Pattern** button on the remote control, then select **Gray Scale**. Then press the **↵ Select** button on the remote control to open the line menu.

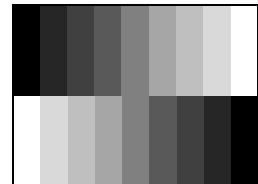

Changing How the Menus Display

Use these options to control how the menus display.

■ Language

Settings → Language

Select from nine languages to use in the menu system.

■ Menu Position

Settings → Display → Menu Position

Use the arrow buttons to choose a position on the screen for displaying the menu.

■ Navigation Bar

Settings → Display → Navigation Bar

Select whether to display the navigation bar, which tells you which buttons to press to choose settings.

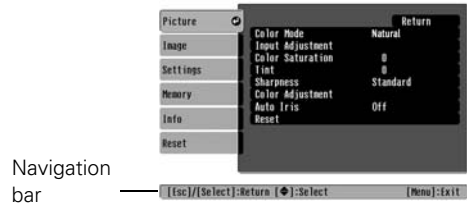

■ Menu Color

Settings → Display → Menu Color

Select a color scheme for displaying the menus.

Adjusting the Picture Quality

Before fine-tuning the image using these adjustments, make sure you have already selected the best Color Mode for your picture and viewing environment, as described on page 28. Then use the settings in this section to finish adjusting the picture to your liking.

Most image quality settings are saved independently for each input source (Video, S-Video, HDMI, Input A, Input B) and color mode. After you finish adjusting the settings for one input source, switch to the other input sources you'll be using and make any necessary adjustments.

Input Brightness Settings

If the signal from connected equipment is weak and images appear dark, you can adjust the White Level/Black Level or the Brightness/Contrast. You can adjust either one of these settings (but not both) for each image source and color mode.

Adjust this setting first, then fine-tune the image with the remaining settings.

The Brightness setting controls how much light is produced by the projector, and the Contrast setting adjusts the difference between the bright and dark areas of the projected image. The other settings listed on the following page control how the projector interprets the light and dark areas of the picture.

■ Brightness/Contrast

Picture → Input Adjustment → Brightness/Contrast

Note: If you cannot access the Brightness and Contrast settings, highlight **Input Adjustment** and press the **↵ Select** button, then choose **Brightness/Contrast** in the sub-menu.

Adjust the brightness so it's suitable for your viewing conditions. For example, if you're projecting in a brightly lit room or onto an especially large screen, you may need to increase the brightness. Decrease the brightness for dark rooms or small screens; this also reduces power consumption and fan noise, and helps to prolong the life of the lamp.

■ White Level/Black Level

Picture → Input Adjustment → White Level/Black Level

Note: If you cannot access the White Level and Black Level settings, highlight **Input Adjustment** and press the **↵ Select** button, then choose **White Level/Black Level** in the sub-menu.

Adjust the White Level so that details in the brightest parts of the image are not washed out. Then adjust the Black Level so that shadow-level details are still visible in the darkest parts of the image.

■ Auto Iris

Picture → Auto Iris

When this setting is on, the amount of light produced by the lamp is automatically adjusted according to the brightness of the image. The setting is stored separately for each image source and color mode.

■ Setup Level

Image → Advanced → Setup Level

This setting adjusts the threshold at which dark areas of the image are rendered black (0 IRE). For compatibility with most DVD and video equipment sold in the United States, leave this setting at 0%. Check your video equipment's specifications to be sure of the correct setting.

■ EPSON Super White

Image → Advanced → EPSON Super White

Note: This setting can be used only when the Color Mode is set to Natural, Cinema Night, HD, or Silverscreen (see page 28).

If bright parts of the image are washed out or overexposed (when the input signal contains values over 100 IRE), turn this setting on to compensate. When this setting is turned on, the projector disregards the DVI-Video Level setting.

■ DVI-Video Level

Image → Advanced → DVI-Video Level

Note: This setting can be used only when HDMI is selected as the image source (see page 22).

If your video equipment has a DVI port and you've connected it to the projector using an HDMI/DVI cable, set the level of the projector to match that of the video equipment. When this setting is turned on, the projector disregards the EPSON Super White setting.

Sharpness and Picture Quality Settings

If the image looks fuzzy, or if it contains noise or flickering, you can use these settings to correct it.

■ Sharpness

Picture → Sharpness

Use this function to make lines and edges appear more distinct in the image. This setting is stored separately for each image source and color mode setting. You can select **Standard** to adjust the sharpness of the entire image, or select **Advanced** to access the following submenu:

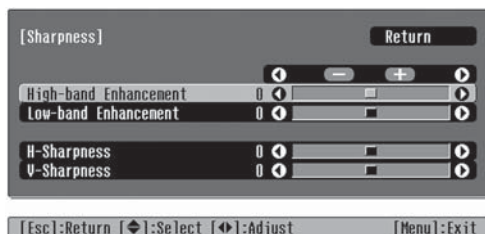

Choose **High-band Enhancement** to sharpen details such as hair and clothing. Choose **Low-band Enhancement** to sharpen large contours and backgrounds.

■ Progressive

Image → Advanced → Progressive

The projector uses 3D DigiScan HD Circuitry Processing for video-sourced images. For film-sourced images, the projector uses 3-2 pulldown detection and optimizes the image accordingly.

Leave this setting on **Video** for most purposes. Set to **Film** when the input source is a film, and you want to project an image closer to its original source.

Note: This setting applies only when viewing composite video, S-video, component video, or 525i or 625i RGB video (see page 63).

Color Settings

If the image colors don't look correct, you can adjust them using these settings. Use the first three settings described below to make the most visible changes. If you only need to make slight adjustments, you can fine-tune the picture with the remaining settings. Most color settings are stored separately for each image source and color mode.

■ Color Saturation

Picture → Color Saturation

Adjusts the color intensity of the image.

■ Tint

Picture → Tint

Shifts the color balance between magenta and green.

■ Abs. Color Temp.

Picture → Color Adjustment → Abs. Color Temp.

Shifts the color balance between red and blue, making the image appear warmer or cooler. You can also access this setting by pressing the **ColorTemp.** button on the remote control. See page 29 for more information.

Note: You can display a test pattern to help adjust the color temperature. See page 34 for more information.

■ Skin Tone

Picture → Color Adjustment → Skin Tone

Makes fine adjustments to the tint. Controls the amount of magenta or green in the image. Also useful for correcting black-and-white images, if they look tinted. You can also access this setting by pressing the **S. Tone** button on the remote control. See page 29 for more information.

■ RGB

Picture → Color Adjustment → RGB/RGBCMY → RGB

Note: If you cannot access the RGB settings, highlight **RGB/RGBCMY** (the first item in the menu list) and press the **↵ Select** button, then choose **RGB** in the sub-menu.

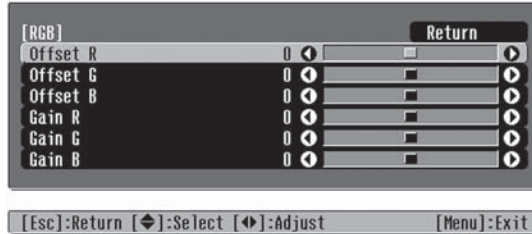

Use the RGB settings to fine-tune the color of the image. You can adjust the offset and gain for each signal color (red, green, and blue). Use **Offset** to adjust darker shades and **Gain** for the lightest shades.

■ RGBCMY

Picture → Color Adjustment → RGB/RGBCMY → RGBCMY

Note: If you cannot access the RGBCMY settings, highlight **RGB/RGBCMY** (the first item in the menu list) and press the **↵ Select** button, then choose **RGBCMY** in the sub-menu.

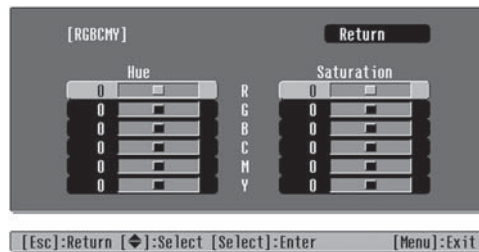

Use the RGBCMY settings to adjust the hue and saturation of the six color components (red, green, blue, cyan, magenta, yellow). After adjusting each color, press **Esc** or select **Return** to move to another menu option.

■ Gamma

Picture → Color Adjustment → Gamma

You can select from 5 gamma settings (2.0 to 2.4) or customize your own setting from your image or a displayed graph. Lower values will increase the contrast of dark areas, but tend to blur the bright areas. Higher values will darken the light areas.

You can also access this setting by pressing the **Gamma** button on the remote control. See page 30 for more information.

Adjustments Just for Computer Images

In addition to the settings described above, you can adjust the Tracking and Sync settings for analog RGB computer images. Normally, these settings are adjusted automatically by the projector. If you notice that the image is blurry or contains dark vertical bands, you may need to adjust the settings yourself.

■ Auto Setup

Image → Auto Setup

Leave this setting on so that the projector automatically adjusts the tracking, sync, and position of the image.

■ Tracking

Image → Tracking

Adjust the tracking to eliminate vertical bands. It is easiest to adjust the tracking when the image contains a lot of fine detail (such as black text on a white background).

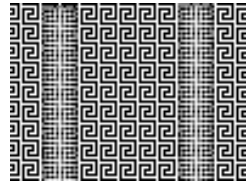

■ Sync.

Image → Sync.

Adjust the synchronization to eliminate blurriness. For best results, make sure the tracking is properly adjusted first.

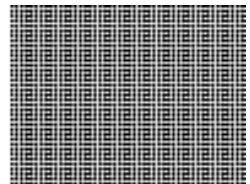

Selecting Memory Settings and Resetting the Projector

Your projector comes with 9 memory locations for ISF-certified installers to save customized settings, designed to provide the best color quality for each of your video inputs.

Selecting Memory Settings

You can easily recall the memory settings by using the memory button on the remote control:

1. Press the **Memory** button on the remote control.
2. Use the arrow buttons to select the desired setting, then press the **Select** button.

After a moment, the image appears on the screen using your selected setting.

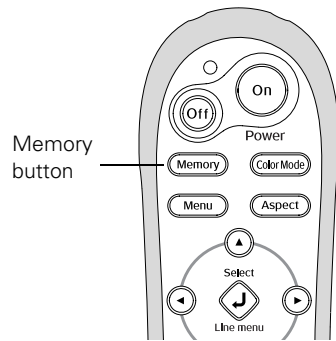

Creating Memory Settings

Memory settings store the Brightness and Contrast settings, White Level, Black Level, Color Mode, and other color settings described on pages 38 and 39.

1. Press the **Menu** button on the remote control.
2. Open the **Memory** menu, then select **Save Memory**.
3. Select the memory name you want to use, then press the **Select** button to save your settings.

Note: Saved settings are indicated by a green highlight next to the memory name. If you select a name that is already in use, the existing settings will be erased and new ones saved in their place.

Deleting Saved Memory Settings

You can clear all your memory settings at once.

1. Press the **Menu** button on the remote control.
2. Open the **Memory** menu, then select **Reset Memory**.
3. Press the **↵ Select** button to delete the memory settings.

Resetting the Projector

If the image quality isn't what you expect, one or more settings may be adjusted improperly. If necessary, you can restore the projector to its factory-default (original) settings.

To restore the settings in a specific menu (such as the Image or Settings menu), open that menu, select **Reset**, and confirm as needed. The example below shows how to reset the Picture menu settings:

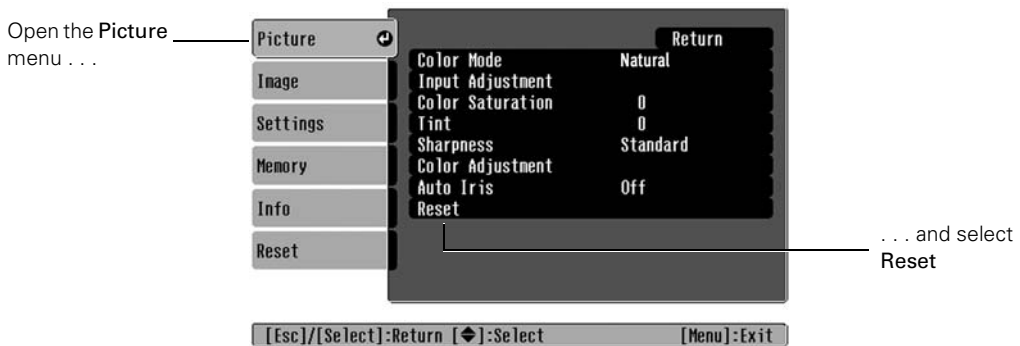

You can also reset the lamp usage timer or restore all the projector settings to their original values. Follow these steps:

1. Press the **Menu** button on the remote control.
2. Open the **Reset** menu.
3. Do one of the following:
 - Select **Reset Lamp Hours** to clear the lamp usage timer and reset it to zero. You should reset the lamp timer only when you install a new projector lamp. See page 52 for more information.
 - Select **Reset All** to return all projector settings to their original defaults (except Input A, Save Memory, and Language).

Customizing Projector Features

Use the settings in this section to adjust the image size and position, suppress on-screen text, and select basic setup options.

Image Sizing

Before adjusting any of these settings, make sure you have already selected an appropriate aspect ratio for the type of picture you're viewing (see page 26).

■ Output Scaling

Image → Advanced → Output Scaling

For component video formats, this setting lets you see the edges of the image that are not normally visible in the picture (see page 63). Select **Larger** to view both the hidden and visible parts of the image. **Normal** displays images at the standard size.

For HDMI signals, select **Auto** for normal operation. Select **Smaller** to show a slightly reduced image if you see interference at the top or bottom of the screen for computer images (displays digital video at standard size). Select **Normal** to expand digital video so it includes both the hidden and visible parts of the picture (displays computer images at full size).

■ Position

Image → Position

Use the arrow buttons to fine-tune the position of the image on the screen.

■ Zoom Caption

Image → Zoom Caption

Lets you adjust the shape and position of the image so that subtitles are visible (available only if the aspect ratio has been set to **Zoom**). Use **Vertical Size** to adjust the proportions of the image, and **Zoom Position** to move the image up or down.

■ Aspect

Image → Aspect

This setting lets you change the aspect ratio of your image, and works the same as pressing the **Aspect** button on the remote control. See page 26 for more information.

Screen Options

■ Message

Settings → Display → Message

Turn this setting off if you want to prevent on-screen messages from appearing (such as the no-signal message, or the identifying text that appears when you switch between image sources or color modes).

■ User's Logo

Settings → User's Logo

Lets you display an image of your choice when the projector is warming up, not receiving a signal, or when you press the **Blank** button to temporarily stop projection.

To capture the image, first set the projector to display the image you want to use. Then select **User's Logo** and follow the instructions on the screen. When done, change the Display Background setting to **Logo**, as described on page 44.

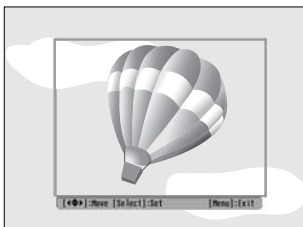

Move the frame to select the area you want to record

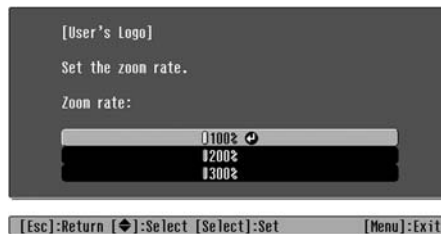

Select the display ratio

Record →

■ Startup Screen

Settings → Display → Startup Screen

Turn this setting off if you want to prevent your logo (see page 44) from appearing while the projector is warming up.

■ Display Background

Settings → Display → Display Background

Changes the screen that's used when the projector is not receiving a signal or when you press the **Blank** button to temporarily stop projection. Select **Blue** (instead of **Black**) or **Logo** to display your logo on a black background.

Other Setup Options

■ Keystone

Settings → Keystone

Adjusts the shape of the image, if the left and right sides are not parallel after tilting the projector up or down at the screen (see page 25).

■ Projection

Settings → Projection

Inverts the image for overhead projection.

■ Direct Power On

Settings → Operation → Direct Power On

Sets projection to start when the main power switch is turned on, without pressing the **On** button on the remote control or the **Power** button on the projector.

Note: When direct power on is enabled, power surges that occur after a power outage can cause the projector to turn on.

■ Video Signal

Settings → Input Signal → Video Signal

Leave this setting on **Auto** so the projector can automatically interpret the format, such as NTSC or PAL (for standard TV formats).

■ Input A

Settings → Input Signal → Input A

Change this setting to match the type of equipment connected to the Input A port.

For component video, select **Auto** to let the projector automatically interpret the signal; or select **YCbCr** or **YPbPr** to manually select your video equipment's signal.

■ Trigger Out

Settings → Operation → Trigger Out

Turn on this setting if you want the **Trigger out** port to output a 12-volt signal while the projector is operating. You can use this to raise or lower your projection screen.

■ Sleep Mode

Settings → Operation → Sleep Mode

Turn off this setting if you don't want the projector to enter sleep mode. (Sleep mode shuts the projector off automatically when there is no video signal.)

Select **30 min.**, **10 min.**, or **5 min.** as the length of time before shutoff; decreasing the time conserves power and extends the life of the lamp.

To turn the projector back on, press the **On** button on the remote control, or press the **Power** button on the projector.

■ Child Lock

Settings → Operation → Child Lock

Lets you lock the **Power** button on the projector's control panel to make it more difficult for a child to turn on the projector. See page 31 for more information.

■ Operation Lock

Settings → Operation → Operation Lock

Lets you disable all the buttons on the projector's control panel to prevent the image from being accidentally changed once it is adjusted. See page 31 for more information.

■ High Altitude Mode

Settings → Operation → High Altitude Mode

Adjusts the speed of the fan so it can properly cool the projector at altitudes above 4,900 feet (1500 meters).

Maintenance

Your projector needs little maintenance. All you need to do on a regular basis is keep the lens clean. You also need to clean the air filter periodically to prevent overheating.

Warning: Before you clean any part of the projector, turn it off and unplug the power cord. Never open any cover on the projector, except the lamp and filter covers. Dangerous electrical voltages in the projector can injure you severely. Do not try to service this product yourself, except as specifically explained in this *User's Guide*.

The only parts you should replace are the air filter and the lamp. If another part needs replacing, contact your dealer or a qualified servicer.

Cleaning the Lens

Clean the lens whenever you notice dirt or dust on the surface.

- Use a canister of compressed air to remove dust.
- To remove dirt or smears, use lens-cleaning paper. If necessary, moisten a soft cloth with lens cleaner and gently wipe the lens surface.

Caution: Never rub the lens with abrasive materials.

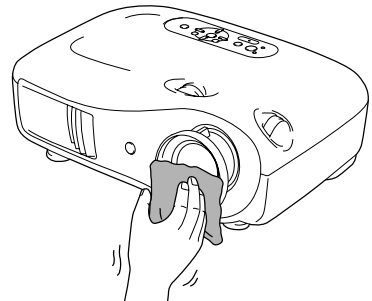

Cleaning the Projector Case

Before you clean the case, turn off the projector and unplug the power cord.

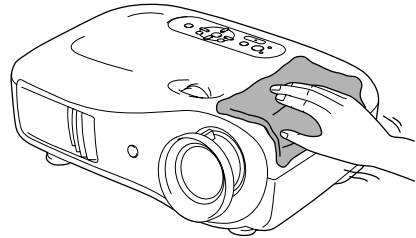

- To remove dirt or dust, wipe the case with a soft, dry, lint-free cloth.
- To remove stubborn dirt or stains, moisten a soft cloth with water and a neutral detergent. Then wipe the case and dry it with a dry cloth.

Caution: Never use wax, alcohol, benzene, thinner, or other chemical detergents. These can damage the case.



Cleaning and Replacing the Air Filter

Clean the air filter on the bottom of the projector once every 3 months, or more often if you're using the projector in a dusty environment. If it's not cleaned periodically, it can become clogged, preventing proper ventilation and causing overheating and damage to the projector.

1. Press the  Power button and wait for the  power light to stop flashing. The projector cools down.
2. Turn off the projector using the power switch on the back.
3. Unplug the power cord and disconnect any cables.
4. Turn the projector over.
5. Use a small vacuum cleaner that is designed for computers and other office equipment to clean the filter, as shown. If you don't have one, gently clean the filter using a very soft brush (such as a clean artist's paintbrush).

If the dirt is difficult to remove or the filter is broken, replace it. Purchase air filter part number V13H134A09 from an authorized Epson reseller. To find the nearest reseller, please call 800-GO-EPSON (800-463-7766). To purchase online, visit www.epsonstore.com (U.S. sales) or www.epson.ca (Canadian sales).

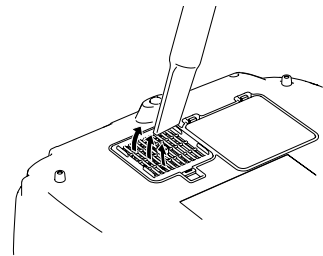

6. If you need to replace the filter, release the tab and lift up the cover

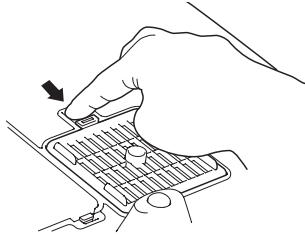

7. Remove the old filter and replace it with a new one.

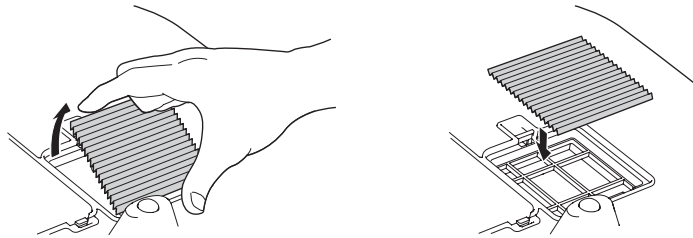

8. To replace the cover, insert the tabs and press down until the cover clicks into place.

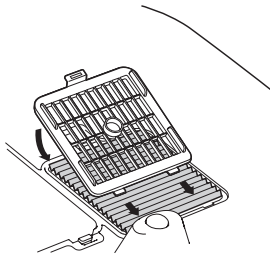

Replacing the Lamp

The projection lamp lasts for up to 3000 hours. You can use the Info menu to check how long it's been in use (see page 53). It's time to replace the lamp when:

- The projected image gets darker or starts to deteriorate.
- The projector's warning light flashes red at half-second intervals.
- The message **Replace the lamp** appears on the screen when you start projecting.

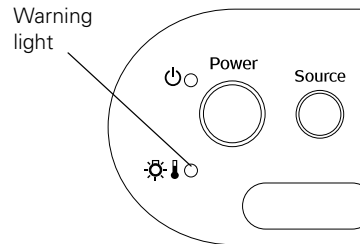

Note: Lamp life results will vary depending on mode selected, environmental conditions, and usage.

Turn off this product when not in use to prolong the life of the projector.

Purchase lamp part number V13H010L35 from an authorized Epson reseller. To find the nearest reseller, please call 800-GO-EPSON (800-873-7766). To purchase online, visit www.epsonstore.com (U.S. sales) or www.epson.ca (Canadian sales).

Be sure to read the “Important Safety Information” on page 67 before replacing the lamp.

Warning: Let the lamp cool fully (about 1 hour) before replacing it. In the unlikely event that the lamp has broken, small glass fragments may be present and should be removed carefully to avoid injury.

Caution: Never touch the lamp with your bare hands; the invisible residue left by the oil on your hands may shorten the lamp life. Use a cloth or glove to handle the new lamp.

Follow these steps to replace the lamp:

1. Press the **Power** button and wait for the light to stop flashing.
2. Turn off the power switch on the back of the projector.
3. Unplug the power cord and any cables.
4. Wait for one hour to make sure the lamp is no longer hot.

5. Press in the latches securing the lamp cover and lift off the cover.

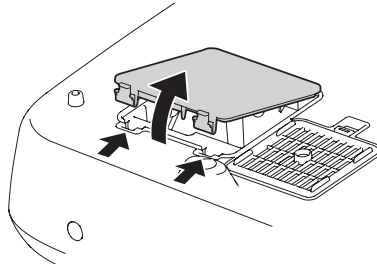

6. Loosen the two screws securing the lamp (they don't come all the way out).

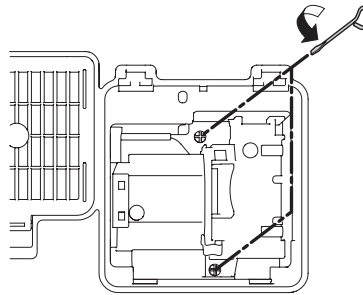

7. Grasp the lamp as shown and pull it straight out.

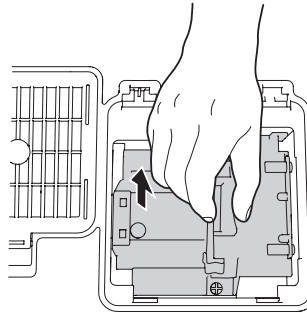

Warning: (Hg) The lamp(s) in this product contain mercury. Please consult your state and local regulations regarding disposal or recycling. Do not put in the trash.

8. Gently insert the new lamp and tighten its screws.

Caution: Don't touch the glass portion of the lamp assembly. Touching the glass could result in premature lamp failure.

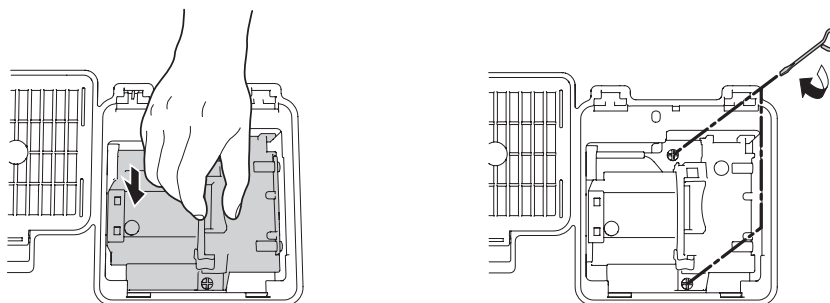

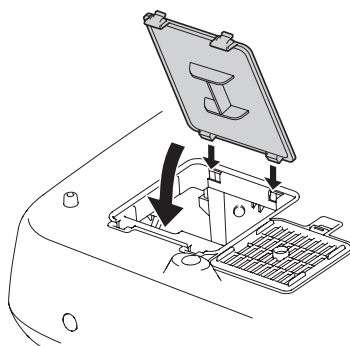

9. Replace the lamp cover. (The projector won't work if the lamp cover is open or loose.)



10. Reset the lamp usage timer, as described below.

Resetting the Lamp Usage Timer

After replacing the lamp, plug the projector back in, turn on the power switch on the back, and press the  Power button. Then follow these steps to reset the lamp usage timer:

1. Press the **Menu** button on the projector or remote control.
2. Use the menu navigation buttons to open the **Reset** menu, then select **Reset Lamp Hours**.
3. When you see a confirmation prompt, highlight **Yes** and press the  **Select** button.
4. When you're finished, press the **Menu** button to exit.

The lamp usage timer doesn't register until you've used the lamp for at least 10 hours.

Checking the Projector Status

You can use the Info menu to view information about the current display settings and how long the projection lamp has been in use. To access the Info menu:

1. Press the **Menu** button on the projector or remote control.
2. Use the menu navigation buttons to open the **Info** menu. The following information appears:

- Lamp Hours
- Source
- Input Signal
- Resolution
- Video Signal
- Refresh Rate
- Sync Info

Note: The information displayed depends on the currently selected image source. The Lamp Hours shows 0H until you've used the lamp for at least 10 hours.

The resolution indicates the total number of scan lines in the source signal. The number of visible scan lines depends on the signal format standard and selected display settings (see page 63).

Storing the Projector

If you need to store the projector for an extended time, do the following:

- Make sure the temperature of the storage area is within 14 to 140 °F (–10 to 60 °C).
- Attach the lens cover and retract the feet.
- Remove the batteries from the remote control.
- Pack the projector in its original packaging or equivalent.

Transporting the Projector

Note: Epson shall not be liable for any damages incurred during transportation.

The projector contains many glass and precision parts. When shipping the projector for repairs, use the original packaging material if possible. If you do not have the original packaging, use equivalent materials. Be sure the carrier is capable of transporting fragile equipment and is aware that the projector is fragile.

Before transporting the projector, make sure you center the lens by turning the lens shift dials until they click.

Problem Solving





This section explains how to interpret the projector's status lights, solve problems with the picture and remote control, and contact technical support.



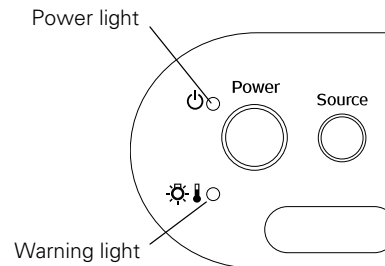

What To Do When the Lights Come On or Flash

The lights on top of the projector indicate the projector's status and let you know when a problem occurs.

If the projector isn't working correctly, first press the **Power** button or the **Off** button on the remote control, let it cool down, turn off the power switch on the back, and unplug it. Then plug the power cord back in and turn on the projector. If this doesn't solve the problem, check the status lights on top of the projector.



Light state	Cause and solution
 power light does not come on	Make sure the power switch on the back of the projector is turned on and the power cord is connected securely both at ends.
 power light is orange	The projector is in standby mode. Turn off the power switch in back to turn off the projector, or press the Power button to turn it on.
 power light is flashing green	The projector is warming up. Wait for the picture to appear.
 power light is flashing orange and you can't turn the projector on or off	The projector is cooling down. Wait until the light stops flashing and shines orange. Then turn off the power switch in back to turn off the projector, or press the Power button to turn it on.



Light state	Cause and solution
 warning light is flashing orange	High-speed cooling is in progress. If the projector gets too hot again, projection stops automatically. Make sure there is plenty of space around and under the projector for ventilation. Clean or replace the air filter if necessary (see page 48).
 warning light is red	<p>The projector is too hot, which turns off the lamp automatically. Let it cool for five minutes, then turn it back on. Make sure there is plenty of space around and under the projector for ventilation. Also, clean or replace the filter if necessary (see page 48).</p> <p>If you are using the projector at an altitude above 4900 feet (1500 meters), turn on High Altitude Mode so the fan can properly cool the projector at the high altitude air pressure (see page 46).</p>
 warning light is flashing red at half-second intervals	The lamp needs to be replaced (see page 50). Make sure you have a spare lamp handy. Check to make sure the lamp and lamp cover are securely installed.
 warning light is flashing red at one-second intervals	There is an internal problem. Turn off the power switch on the back of the projector, and unplug it from the electrical outlet. Then contact Epson for assistance (see page 60).

Solving Picture Problems

You cannot turn on the projector.

- Make sure the power cord is connected and the power switch is turned on. Then wait a moment for the power light to turn orange before pressing the  **Power** button.
- If you've set the **Operation Lock**, the control panel buttons are disabled; you must use the remote control to turn on the projector (see page 31).

No picture appears on the screen or you see the No Signal message displayed.

- Press the **Source** button on the projector or one of the **Source** buttons on the remote control to select the correct input source. Allow a few seconds for the projector to sync up after pressing the button.
- Press the **Blank** button on the remote control to make sure the picture hasn't been turned off temporarily.
- Check that the  power light is green, not flashing, and the lens cover is off.
- The projector may be in standby (or sleep) mode. If the  power light is orange, press the **Power** button to turn the projector back on.
- Make sure your video equipment is turned on.
- Make sure your cable(s) are connected correctly (see page 18).

You're using a computer and no picture appears on the screen.

If you're using a PC laptop:

- Press the function key that lets you display on an external monitor. It's often labeled with an icon such as , but it may also be labeled **CRT/LCD**. You may have to hold down the **Fn** key while pressing it. Check your laptop's manual or online help.

On most systems, the  key lets you toggle between the LCD screen and the projector, or display on both at the same time. Allow a few seconds for the projector to sync up after pressing it.

- If the function key doesn't let you display simultaneously on both screens, you might need to use the Display utility in the Windows Control Panel to make sure that both the LCD screen and external monitor port are enabled. From the Windows Control Panel, open the **Display** utility. In the Display Properties dialog box, click the **Settings** tab, then click **Advanced**. The method for adjusting the setting varies from computer to computer; you may need to click a **Monitor** tab, then make sure the external Monitor port is set as your primary display or enabled. See your computer manual or online help for details.

If you're using a Macintosh with OS X:

1. Select **System Preferences** from the Apple menu and click **Displays**.
2. Click **Detect Displays**.
3. To display the entire desktop on both your projector screen and LCD screen, click the **Arrange** tab. (If you don't see this tab, make sure it isn't hidden by another window.)

4. Click **Mirror Displays** in the lower corner of the screen. One of the monitor icons automatically moves on top of the other.

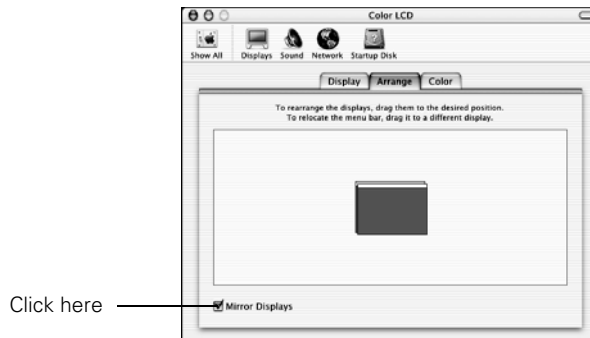





The picture is upside-down or reversed.

Change the **Projection** setting in the Settings menu (see page 45).

Only part of the picture is displayed, or the picture is distorted.

- Press the **Aspect** button to select a different aspect ratio (see page 26).
- If the **Aspect** is set to **Zoom**, you may need to use the **Zoom Caption** option to see the top or bottom section of the screen so that subtitles are visible (see page 43).
- Check the **Output Scaling** to make sure it's adjusted correctly (see page 43).
- Use the **Position** setting to reposition the image on the screen (see page 43).
- If you've connected a computer and you see only half the image, make sure the computer's **Dual Display** setting is turned off.

The picture isn't rectangular.

- If the image looks like  or , the projector has been placed off to one side of the screen and angled toward it. Face the projector straight ahead (instead of at the center of the screen), then use the horizontal lens shift dial to center the image (see page 24).
- If the image looks like  or , use the remote control to access the **Keystone** function to correct its shape (see page 25). Or press the **▲** and **▼** buttons on the projector's control panel.

Note: You won't have to use the **Keystone** function to correct the image, as long as you place the projector level (not angled up or down) and at a height between the top and bottom of the screen. Then use the vertical lens shift dial to position the image. This produces the best-looking picture.

The picture contains static or noise.

- Make sure the **Input Signal** is set correctly for your connected video equipment (see page 45).
- If you're viewing still images and you notice flickering or horizontal lines, turn on the **Progressive** setting (see page 37).
- Make sure your cables are securely connected at both ends.
- If you're using an extension cable, you may pick up interference unless you use a signal amplifier.
- If you're displaying the same image on your computer and projector screen, try turning off your laptop's LCD display (see page 57).

The picture is blurry.

- Make sure the **Input Signal** is set correctly for your video equipment (see page 45).
- There may be dirt on the lens. Clean the lens as described on page 47.
- Adjust the focus (see page 26).
- Make sure the lens is not fogged by condensation. If you've just moved the projector from a cold environment, wait a couple of minutes before using it.
- Adjust the **Sharpness** setting (see page 37).
- If you're projecting from a computer, you may need to adjust the **Tracking and Sync** settings (see page 40).

The colors on the screen don't look right.

- Make sure the **Input Signal** is set correctly for your connected video equipment (see page 45).
- Press the **Color Mode** button on the remote control to select a different color mode (see page 28).
- Check the brightness and contrast settings (see page 35).
- Fine-tune the colors with the settings listed on page 38.
- If the picture looks dark, you may need to replace the lamp. Check the lamp usage timer to see how long the lamp has been in use (see page 53). Replace the lamp if it's close to the end of its service life (see page 50).

Solving Remote Control Problems

The projector doesn't respond to remote control commands.

- Make sure you're within about 30 feet of the projector, and the remote control is not angled away from the projector by more than 30° in any direction.
- You may need to replace the remote control's batteries (see page 20).
- Dim the room lights and turn off any fluorescent lights. Make sure the projector is not in direct sunlight.
- Turn off nearby equipment that emits infrared energy, such as a radiant room heater.

Where To Get Help

Epson provides technical assistance 24 hours a day at <http://support.epson.com>. Here you can access troubleshooting information, download product documentation, and receive technical advice through e-mail.

To use the Epson PrivateLine Support service, call (800) 637-7661 and enter the PIN on the Epson PrivateLine Support card that came with your projector. This is the fastest way of speaking to a live representative, and it's free. This service is available 6 AM to 6 PM, Pacific Time, Monday through Friday, for the duration of your warranty period.

You may also speak with a projector support specialist by dialing one of these numbers:

- U.S.: (562) 276-4394, 6 AM to 6 PM, Pacific Time, Monday through Friday
- Canada: (905) 709-3839, 6 AM to 6 PM, Pacific Time, Monday through Friday

Toll or long distance charges may apply.

Before you call, please have the following information ready:

- Product name (Epson PowerLite Pro Cinema 800)
- Product serial number (located on the bottom of the projector)
- Computer configuration, if you're connected to a computer
- Description of the problem

You can purchase screens, carrying cases, or other accessories from an authorized Epson reseller. To find the nearest reseller, please call 800-GO-EPSON (800-463-7766). To purchase online, visit www.epsonstore.com (U.S. sales) or www.epson.ca (Canadian sales).

Specifications

General

Type of display	Poly-silicon TFT active matrix
Size of LCD panels	0.7 inch (18 mm) wide
Lens	F=2.1 to 2.8, f=21.4 to 31.7 mm
Resolution (native format)	1280 × 720 pixels, 720p
Brightness	1600 ANSI lumens maximum
Dynamic contrast ratio	5000:1
Image size	30 to 300 inches
Projection distance	2.9 to 44.8 feet (0.88 to 13.65 m) at 16:9 3.5 to 54.8 feet (1.07 to 16.71 m) at 4:3
Zoom ratio	1:1.5
Aspect ratio	16:9 or 4:3
Noise level	32 dB (Vivid color mode) 26 dB (HD/Sliverscreen color mode)
Keystone correction	Vertical: -15 to +15°

Lamp

Note: Lamp life results will vary depending on mode selected, environmental conditions, and usage.

Turn off this product when not in use to prolong the life of the projector.

Type	UHE (Ultra High Efficiency), E-TORL
Power consumption	170 W
Lamp life	1700 to 3000 hours, depending on usage
Part number	V13H010L35

Remote Control

Range	Approximate 30 feet (10 m)
Batteries	AA × 2

Dimensions

Height	4.9 inches (124 mm); not including adjustable feet
Width	16 inches (406 mm)
Depth	12.2 inches (309 mm)
Weight	11.5 lb. (5.2 kg)

Electrical

Rated frequency	50/60 Hz AC
Power supply	100 to 120 VAC, 2.7 A 200 to 240 VAC, 1.2 A
Power consumption	Operating: 245 W (100 to 120V), 240 W (200 to 240 V) Standby: 4 W (100 to 120V), 5 W (200 to 240 V)

Environmental

Temperature	Operating: 41 to 95 °F (5 to 35 °C) Storage: 14 to 140 °F (-10 to 60 °C)
Humidity	Operating: 20 to 80% RH, non-condensing Storage: 10 to 90% RH, non-condensing
Operating altitude	7500 feet (2280 meters)

Safety

United States	FCC Part 15B Class B (DoC) UL60950 Third Edition
Canada	ICES-003 Class B CSA C22.2 No. 60950

Pixelworks™ ICs are used in this projector.

Compatible Video Formats

The projector supports analog video in NTSC, PAL, and SECAM formats, and it automatically adjusts to the incoming signal. It can receive these formats as composite video, S-video, or component video—which it accepts through the Video, S-Video, and Input A ports, respectively.

The projector also supports digital video (SDTV, HDTV) and various monitor display formats. Digital video is accepted by the HDMI port and the Input A port (in component video format). The Input B port accepts analog RGB computer monitor signals.

If necessary, you can select a different Aspect setting to optimize the image. The resolution at which the image displays for a given setting depends on the currently active picture source, as listed in the following tables.

Composite video or S-Video

Format	Aspect setting				
	Normal (4:3)	Zoom (16:9)	Squeeze/Wide (16:9)	Through (4:3)	Squeeze Through (16:9)
NTSC	960 × 720	1280 × 720	1280 × 720	596 × 446	794 × 446
PAL or SECAM	960 × 720	1280 × 720	1280 × 720	708 × 528	944 × 528

Component video

Format/ Signal	Aspect setting					
	Normal	Zoom	Squeeze	Wide	Through	Squeeze Through
SDTV	(4:3)	(16:9)	(16:9)	(16:9)	(4:3)	(16:9)
480i	960 × 720	1280 × 720	1280 × 720	1280 × 760	596 × 446	794 × 446
576i	960 × 720	1280 × 720	1280 × 720	1280 × 760	708 × 528	944 × 528
480p	960 × 720	1280 × 720	1280 × 720	1280 × 760	596 × 446	794 × 446
576p	960 × 720	1280 × 720	1280 × 720	1280 × 760	708 × 528	944 × 528
HDTV	(16:9)				(16:9)	
720p	1280 × 720	—	—	—	1176 × 664	—
1080i	1280 × 720	—	—	—	—	—

Note: The signal name refers to the total number of visible scan lines and the display mode (interlaced or progressive), as defined by the signal format.

Analog RGB

Signal (4:3)	Aspect setting					
	Normal	Zoom	Wide	Squeeze	Through	Squeeze Through
VGA*	960 × 720	1280 × 720	1280 × 720	1280 × 720	640 × 480	853 × 480
VESA	960 × 720	1280 × 720	1280 × 720	1280 × 720	640 × 480	853 × 480
SVGA	960 × 720	1280 × 720	1280 × 720	1280 × 720	800 × 600	1066 × 600
XGA	960 × 720	1280 × 720	1280 × 720	1280 × 720	—	—
SXGA	960 × 720	1280 × 720	1280 × 720	1280 × 720	—	—
WXGA	1280 × 720	1280 × 720	—	1280 × 720	—	—
MAC13"	960 × 720	1280 × 720	1280 × 720	1280 × 720	640 × 480	853 × 480
MAC16"	960 × 720	1280 × 720	1280 × 720	1280 × 720	832 × 624	1109 × 624
MAC19"	960 × 720	1280 × 720	1280 × 720	1280 × 720	—	—
SDTV*						
480i	960 × 720	1280 × 720	1280 × 720	1280 × 720	640 × 480	853 × 480
480p	960 × 720	1280 × 720	1280 × 720	1280 × 720	640 × 480	853 × 480
576i	960 × 720	1280 × 720	1280 × 720	1280 × 720	768 × 576	1024 × 576
576p	960 × 720	1280 × 720	1280 × 720	1280 × 720	768 × 576	1024 × 576
HDTV*						
720p	1280 × 720	—	—	—	1280 × 720	—
1080i	1280 × 720	—	—	—	—	—

* HDMI input signals

ESC/VP21 Command Codes

You can use an AV controller with a 9-pin null modem serial cable to control the projector. You can download the complete *ESC/VP 21 Communication Manual* for home theater projectors from the Epson website at <http://support.epson.com>. Following are some of the available codes:

Item		Command		
Power ON/OFF	ON	PWR ON		
	OFF	PWR OFF		
A/V Mute ON/OFF	ON	MUTE ON		
	OFF	MUTE OFF		
A/V Mute selection	Black	MSEL 00		
	Blue	MSEL 01		
	User's Logo	MSEL 02		
Source change	Terminal	Signal name		
	Input A	4RCA	SOURCE 10	
		YCbCr	SOURCE 14	
		YPbPr	SOURCE 15	
		Auto	SOURCE 1F	
	Input B	HDB15	SOURCE 20	
		RGB	SOURCE 21	
	Input 3 (HDMI)	HDMI	SOURCE 30	
	Video	Cyclic within SOURCE 4X		SOURCE 40
		Video (RCA)		SOURCE 41
		S-Video		SOURCE 42
	Input 5	D4	SOURCE C0	
		YCbCr	SOURCE C4	
		YPbPr	SOURCE C5	
Auto		SOURCE CF		
Color Mode	Standard	CMODE 01		
	Cinema Night	CMODE 05		
	Cinema Day	CMODE 06		
	Natural	CMODE 07		
	Vivid	CMODE 08		
	HD	CMODE 09		
	Silverscreen	CMODE 0A		

Item	Command	
Aspect ratio	Auto	ASPECT 00
	Normal	ASPECT 20
	Squeeze	ASPECT 21
	Zoom	ASPECT 22
	Through	ASPECT 23
	Squeeze Through	ASPECT 24
	Wide	ASPECT 25

Notices

Important Safety Information

Follow these safety instructions when setting up and using the projector:

- Never look into the projector lens when the lamp is turned on; the bright light can damage your eyes. Never let children look into the lens when it is on.
- Never open any cover on the projector, except the lamp and filter covers. Dangerous electrical voltages inside the projector can severely injure you.
- Except as specifically explained in this *User's Guide*, do not attempt to service this product yourself. Refer all servicing to qualified service personnel.
- The projector and its accessories come packaged in plastic bags. Keep plastic bags away from small children to avoid any risk of suffocation.
- Don't place the projector on an unstable cart, stand, or table. Also, don't use the projector near water or sources of heat.
- Use the type of power source indicated on the projector. If you're not sure of the power available, consult your dealer or power company.
- Place the projector near a wall outlet where the plug can be easily unplugged.
- Don't insert the plug into an outlet with dust present, and insert the plug firmly into the outlet. Failure to do so could result in sparks or fire.
- Don't overload wall outlets, extension cords, or integral convenience receptacles. This can cause fire or electric shock.
- Don't block the slots and openings in the projector case. They provide ventilation and prevent the projector from overheating. Don't operate the projector on a sofa, rug, or other soft surface, or in a closed-in cabinet unless proper ventilation is provided.
- Never push objects through the cabinet slots or spill liquid into the projector.
- Unplug the projector from the wall outlet and refer servicing to qualified service personnel under the following conditions: when the power cord or plug is damaged or frayed; if liquid has been spilled into the projector, or if it has been exposed to rain or water; if it doesn't operate normally when you follow the operating instructions, or if it exhibits a distinct change in performance, indicating a need for service; if it has been dropped or the housing has been damaged.
- Don't place the projector where the cord can be walked on. This may result in fraying or damage to the plug.
- Unplug the projector from the wall outlet before cleaning. Use a damp cloth for cleaning. Do not use liquid or aerosol cleaners.

- (Hg) The lamp(s) in this product contain mercury. Please consult your state and local regulations regarding disposal or recycling. Do not put in the trash.
- Allow the lamp to cool for one hour before replacing it.
- Unplug the projector during lightning storms or when not in use for extended periods.
- Don't place the projector or remote control on top of heat-producing equipment.
- If you use the projector in a country other than where you purchased it, use the correct power cord for that country.
- Don't stand on the projector or place heavy objects on it.
- Don't use the projector outside of the required temperature range of 41 to 95 °F (5 to 35 °C). Doing so may cause an unstable display and could lead to projector damage.
- Don't store the projector outside of the required temperature range of 14 to 140 °F (–10 to 60 °C) or in direct sunlight for long periods of time. Doing so may cause damage to the case.

WARNING: The cords included with this product contain chemicals, including lead, known to the State of California to cause birth defects or other reproductive harm. **Wash hands after handling.** (posted in accordance with Proposition 65 in Cal. Health & Safety Code § 2549.5 et seq)

Remote Control Information

You can operate the projector by remote control via a line-of-sight infrared (IR) receiver at the front and rear of the projector. The projector may not respond to remote control commands under the following conditions:

- There is an object between the remote control and the IR receiver on the projector.
- Ambient light is too bright.
- Certain types of fluorescent lighting are used.
- Other equipment that emits infrared energy, such as a radiant room heater, is in the room.

If you experience problems, try the following:

- The remote control's batteries may be low on power; replace them.
- Dim the ambient lighting and/or turn off any fluorescent lights.
- Close any window coverings and/or move the projector out of direct sunlight.
- Turn off other equipment that emits infrared energy.

FCC Compliance Statement

For United States Users

This equipment has been tested and found to comply with the limits for a Class B digital device, pursuant to Part 15 of the FCC Rules. These limits are designed to provide reasonable protection against harmful interference in a residential installation. This equipment generates, uses, and can radiate radio frequency energy and, if not installed and used in accordance with the instructions, may cause harmful interference to radio or television reception. However, there is no guarantee that interference will not occur in a particular installation. If this equipment does cause interference to radio and television reception, which can be determined by turning the equipment off and on, the user is encouraged to try to correct the interference by one or more of the following measures:

- Reorient or relocate the receiving antenna.
- Increase the separation between the equipment and receiver.
- Connect the equipment into an outlet on a circuit different from that to which the receiver is connected.
- Consult the dealer or an experienced radio/TV technician for help.

WARNING

The connection of a non-shielded equipment interface cable to this equipment will invalidate the FCC Certification of this device and may cause interference levels which exceed the limits established by the FCC for this equipment. It is the responsibility of the user to obtain and use a shielded equipment interface cable with this device. If this equipment has more than one interface connector, do not leave cables connected to unused interfaces. Changes or modifications not expressly approved by the manufacturer could void the user's authority to operate the equipment.

For Canadian Users

This Class B digital apparatus meets all requirements of the Canadian Interference-Causing Equipment Regulations.

Declaration of Conformity

According to 47CFR, Part 2 and 15 for Class B Personal Computers and Peripherals; and/or CPU Boards and Power Supplies used with Class B Personal Computers:

We: Epson America, Inc.
Located at: 3840 Kilroy Airport Way
MS 3-13
Long Beach, CA 90806-2469
Telephone: (562) 290-5254

Declare under sole responsibility that the product identified herein, complies with 47CFR Part 2 and 15 of the FCC rules as a Class B digital device. Each product marketed is identical to the representative unit tested and found to be compliant with the standards. Records maintained continue to reflect the equipment being produced can be expected to be within the variation accepted, due to quantity production and testing on a statistical basis as required by 47CFR §2.909. Operation is subject to the following two conditions: (1) this device may not cause harmful interference, and (2) this device must accept any interference received, including interference that may cause undesired operation.

Trade Name: Epson
Type of Product: Projector
Model: EMP-TW800
Marketing Name: PowerLite Pro Cinema 800

Epson America, Inc., Limited Warranty

Basic Two-Year Warranty and 90-Day Lamp Warranty

What Is Covered: Epson America, Inc. (“Epson”) warrants to the original retail purchaser of the Epson product enclosed with this limited warranty statement that the product, if purchased new and operated in the United States or Canada, will be free from defects in workmanship and materials for a period of two (2) years from the date of original purchase (except that the warranty period is 90 days for projector lamps). For warranty service, you must provide proof of the date of original purchase.

What Epson Will Do To Correct Problems: If your product requires service, Epson will ask you to bring the product securely packaged in its original container or equivalent, along with proof of the date of original purchase, to your Epson Dealer or Epson Customer Care Center as instructed by Epson. Epson will, at its option, repair or replace the defective unit, without charge for parts or labor. When warranty service involves the exchange of the product or of a part, the item replaced becomes Epson property. The exchanged product or part may be new or previously refurbished to the Epson standard of quality, and at Epson's option, the replacement may be another model of like kind and quality. Epson's liability for replacement of the covered product will not exceed the original retail selling price of the covered product. Exchange or replacement products or parts assume the remaining warranty period of the product covered by this limited warranty. However, each replacement lamp carries the limited 90-day warranty stated above.

What This Warranty Does Not Cover: This warranty does not apply to refurbished or reconditioned products. This warranty covers only normal use of the product. 24-hour-per-day or other high duty commercial use causes strain and is not considered normal use. This warranty does not cover consumables (e.g., filters), other than lamps as provided herein. This warranty is not transferable. Epson is not responsible for warranty service should the Epson label or logo or the rating label or serial number be removed. Epson is not responsible for warranty service should the product fail to be properly maintained or fail to function properly as a result of misuse, abuse, improper installation, neglect, improper shipping, damage caused by disasters such as fire, flood, and lightning, improper electrical current, software problems, interaction with non-Epson products, use in a smoke or dust-filled environment, or service other than by an Epson Authorized Servicer. Postage, insurance, or shipping costs incurred in presenting your Epson product for carry-in warranty service are your responsibility. If a claimed defect cannot be identified or reproduced in service, you will be held responsible for costs incurred.

THE WARRANTY AND REMEDY PROVIDED ABOVE ARE EXCLUSIVE AND IN LIEU OF ALL OTHER EXPRESS OR IMPLIED WARRANTIES INCLUDING, BUT NOT LIMITED TO, THE IMPLIED WARRANTIES OF MERCHANTABILITY OR FITNESS FOR A PARTICULAR PURPOSE. SOME LAWS DO NOT ALLOW THE EXCLUSION OF IMPLIED WARRANTIES. IF THESE LAWS APPLY, THEN ALL EXPRESS AND IMPLIED WARRANTIES ARE LIMITED TO THE WARRANTY PERIOD IDENTIFIED ABOVE. UNLESS STATED HEREIN, ANY STATEMENTS OR REPRESENTATIONS MADE BY ANY OTHER PERSON OR FIRM ARE VOID. IN THE EVENT THE REMEDIES ABOVE FAIL, EPSON'S ENTIRE LIABILITY SHALL BE LIMITED TO A REFUND OF THE PRICE PAID FOR THE EPSON PRODUCT

COVERED BY THIS LIMITED WARRANTY. EXCEPT AS PROVIDED IN THIS WRITTEN WARRANTY, NEITHER EPSON AMERICA, INC. NOR ITS AFFILIATES SHALL BE LIABLE FOR ANY LOSS, INCONVENIENCE, OR DAMAGE, INCLUDING DIRECT, SPECIAL, INCIDENTAL, OR CONSEQUENTIAL DAMAGES, RESULTING FROM THE USE OR INABILITY TO USE THE EPSON PRODUCT, WHETHER RESULTING FROM BREACH OF WARRANTY OR ANY OTHER LEGAL THEORY.

In Canada, warranties include both warranties and conditions.

Some jurisdictions do not allow limitations on how long an implied warranty lasts and some jurisdictions do not allow the exclusion or limitation of incidental or consequential damages, so the above limitations and exclusions may not apply to you. This warranty gives you specific legal rights, and you may also have other rights, which vary from jurisdiction to jurisdiction.

To find the Epson Authorized Reseller nearest you, visit our website at: www.epson.com.

To find the Epson Customer Care Center nearest you, visit <http://support.epson.com>.

You can also call the Epson ConnectionSM at (800) 637-7661 + PIN or (562) 276-4394 in the U.S. and (905) 709-3839 in Canada or write to: Epson America, Inc., P.O. Box 93012, Long Beach, CA 90809-3012.

Index

A

- Abs. Color Temp. setting, 29, 38
- Accessories, 11, 60
- Adjustment pattern, 34
- Air filter
 - cleaning and replacing, 48 to 49
 - ordering, 11
- Anti-theft device, 8, 11
- Aspect button, 10, 26, 58
- Aspect ratio, selecting, 26, 43
- Auto Iris setting, 36
- Auto Setup, 40

B

- Batteries, remote control, 20
- Black level, 36
- Blank button, 10, 23
- Blurry picture, 59
- Brightness
 - setting, 36
 - specification, 61

C

- Cables, connecting, 18 to 20
- Child Lock, 31, 46
- Cleaning
 - air filter, 48 to 49
 - lens and projector case, 47, 48
- Codes, AV controller, 65
- Color
 - adjusting, 28 to 30, 38 to 39
 - problems, 59
- Color Mode, 10, 28, 59
- Color Saturation setting, 38
- Color temperature setting, 29, 38

- ColorTemp. button, 10
- Computer, displaying an image, 57 to 58
- Contrast
 - button, 10
 - ratio, 61
 - setting, 36
- Control panel, projector, 9

D

- Declaration of Conformity, 70
- Direct Power On, 45
- Display Background setting, 44
- Documentation, 12
- DVI-Video Level setting, 37

E

- Electrical requirements, 62
- Epson
 - accessories, 11, 60
 - Home Service, 11
 - PrivateLine Support, 60
 - technical support, 12, 60
 - warranty, 11, 71 to 72
- EPSON Super White setting, 36
- ESC/VP21 command codes, 65

F

- FCC Compliance Statement, 69
- Filter, *see* Air filter
- Flickering, 37, 59
- Focus ring, 26

G

Gain, color, 39
Gamma, 29 to 30, 39
Gamma button, 10

H

HDMI, 7, 18, 19
Help, 60
High Altitude Mode, 46
Home Service, 11

I

Illumination of buttons, 20
Image
 adjusting, 25 to 30, 35 to 40
 changing aspect ratio, 26
 positioning, 24, 43
 resizing, 26, 43
 selecting source, 22
Image problems, 56 to 59
Info menu, 53
Input A setting, 45
Installing projector, 16 to 17
Interference, signal, 59
Interlaced mode setting, 37

K

Kensington anti-theft device, 8, 11
Keystone buttons, 9
Keystone correction, 14, 25, 45, 58

L

Lamp
 checking usage timer, 53
 life, 61
 ordering, 11, 50
 replacing, 50 to 52
 resetting usage timer, 52
 safety instructions, 67 to 68
 specifications, 61
Language setting, 34
Lens shift dials, 24
Lens, cleaning, 47
Lights, projector, 55 to 56
Line menu, 10, 34
Lock
 Kensington, 8, 11
 projector buttons, 31

M

Memory button, 10, 41
Memory settings
 creating, 41
 using, 41
Menu button, 10, 33
Menus
 available settings, 34 to 46
 customizing, 34
 line menu, 10, 34
 using, 33
Message setting, 44
Mounting projector, 17
Moving projector, 54

N

Navigation bar, displaying, 35
No image, 57 to 58

O

- Offset, color, 39
- Operation Lock, 31, 46
- Output scaling, 43

P

- Pattern button, 10
- Pattern, adjustment, 34
- Picture problems, 56 to 59
- Pixelworks, 62
- Positioning image, 24, 43
- Positioning projector, 13 to 15
- PrivateLine Support, 60
- Problems
 - picture, 56 to 59
 - remote control, 60, 68
- Progressive mode setting, 37
- Projection distance, 15, 61
- Projector
 - checking status, 53
 - cleaning, 48
 - control panel, 9
 - dimensions, 16, 62
 - installing, 16 to 17
 - lights, 55 to 56
 - locking, 8, 11, 31
 - menus, 34 to 46
 - parts, 8 to 9
 - positioning, 13 to 15
 - resetting menu options, 42
 - storing, 53
 - transporting, 54
 - turning on and off, 21 to 22, 56

R

- Registration, 11
- Remote control
 - batteries, 20
 - buttons, 10
 - lighting up buttons, 20
 - problems, 60, 68
- Replacing lamp, 50 to 52
- Resetting
 - lamp usage timer, 42, 52
 - projector settings, 42
- Resolution
 - compatible formats, 63 to 64
 - projector, 53, 61
- RGB settings, 39
- RGBCMY settings, 39

S

- Safety approvals, 62
- Safety instructions, 67 to 68
- Setup level, 36
- Sharpness, 37
- Skin Tone
 - button, 10
 - setting, 29, 38
- Sleep mode, 46
- Source buttons, 9, 10
- Source, selecting image, 22
- Specifications
 - compatible video formats, 63 to 64
 - dimensions, 62
 - electrical, 62
 - environmental, 62
 - general, 61
 - lamp, 61
 - remote control, 61
- Squeeze mode, 27
- Startup screen, selecting, 44
- Static, 59
- Storing projector, 53
- Support, 12, 60
- Sync (Synchronization) setting, 40

T

Technical support, 12, 60
Through setting, 27
Tint, 38
Tracking, 40
Transporting projector, 54
Trigger Out setting, 45
Trigger port, 20
Turning on and off projector, 21 to 22, 56

U

User's Logo setting, 44

V

Video Signal setting, 45
Video, compatible formats, 63 to 64
VP21 codes, 65

W

Warranty, 11, 71 to 72
Where to Get Help, 60
White level, 36
Wide setting, 27

Z

Zoom Caption setting, 27, 43
Zoom ring, 26
Zoom setting, 27