

# **AUTO Logic™ 110, 175 & 200** **AURA Logic™**



## **User Manual**



# Contents

<b>Introduction</b> .....	<b>1</b>
About this Manual .....	1
About Auto Logic™ .....	1
<b>Clinical Applications</b> .....	<b>6</b>
Indications .....	6
Contra-Indications .....	6
<b>Installation</b> .....	<b>7</b>
Preparing the Auto Logic systems for use .....	7
Installing the Auto Logic 110, 175 or the 200 Mattress .....	7
Installing the Pump .....	10
Installing the Aura Logic Seat cushion. ....	12
<b>Controls, Alarms and Indicators</b> .....	<b>14</b>
Controls .....	14
Alarms and Indicators .....	15
<b>Operation</b> .....	<b>16</b>
Quick Start .....	16
Comfort Control .....	16
Power Fail Condition .....	17
To Disconnect the Tube-set. ....	17
Transport Mode .....	17
To Deflate and Store the Auto Logic Mattress. ....	18
To Deflate the Aura Logic Seat Cushion .....	18
CPR Control. ....	19
<b>Patient Handset and Battery Pack</b> .....	<b>20</b>
Installing the Patient Handset .....	20
Installing the Battery Pack .....	20
Battery Storage and Disposal .....	21
Checking the Status of the Battery Pack .....	22
Charging the Battery Pack. ....	23
<b>Decontamination</b> .....	<b>24</b>
During Use. ....	24
<b>Routine Maintenance</b> .....	<b>25</b>
Auto Logic System. ....	25
Auto Logic Pump .....	25
Auto Logic 110, 175 & 200 and Aura Logic Seat Cushion .....	25
Serial Labels .....	25
<b>Troubleshooting</b> .....	<b>26</b>
<b>Warranty and Service</b> .....	<b>27</b>

**Technical Description** .....28  
    Cover options and features ..... 31

## General Safety

Before you connect the system pump to a mains socket, read carefully all the installation instructions in Section 3 - Installation. The system has been designed to comply with regulatory safety standards including EN60601-1:1990/A13:1996.

### Safety Warnings

- The cover of this product is vapour permeable but not air permeable and may present a suffocation risk. It is the responsibility of the care giver to ensure that the user can use this product safely.
- Electrical equipment may be hazardous if misused. The pump's case back should only be removed by authorised technical personnel.
- Do not use the pump in the presence of flammable gases such as anaesthetic agents.
- To assess suitability of safety sides for the **AUTO Logic™ 175** mattress replacement, the mattress provides a patient position equivalent to a 160mm thick foam hospital mattress. We would therefore recommend that in most cases safety sides of at least 380mm (160+220mm)<sup>1</sup> above the mattress support platform are used with this product. The **AUTO Logic™ 200** mattress replacement provides a patient position equivalent to a 175mm thick foam hospital mattress. We would therefore recommend that in most cases safety sides of at least 395mm (175+220mm)<sup>1</sup> above the mattress support platform are used with this product. However, as with all bed and mattress combinations, it is important for the carers to make decisions on safety sides based on clinical assessment and in line with local hospital policy.
- When assessing the suitability of safety sides for the **AUTO Logic™ 110** mattress overlay, we recommend using safety side extensions due to the varying thickness of hospital mattresses. However, as with all bed and mattress combinations, it is important for the carers to make decisions on safety sides based on clinical assessment and in line with local hospital policy.
- Whilst patient is unattended, safety sides should be used in line with the above information and local hospital policy.
- Alignment of the bed frame, safety sides and the system should leave no gap wide enough to entrap a patient's head or body. Care should be exercised to prevent occurrence of gaps by compression or movement of the mattress. Death or serious injury may occur.

Due to the inherently lower flame retardancy of the high performance eVENT®<sup>2</sup> fabric, it is NOT suitable for use in the homecare environment.

1. IEC 601-2-38 states that there must be a minimum clearance of 220mm between the top of the safety sides and the top of the mattress when the bed is flat and the mattress uncompressed.
2. eVENT® is a registered trademark of BHA Technologies Inc.

## Precautions

For your own safety and the safety of the equipment, always take the following precautions:

- Placing extra layers between the patient and the mattress/seat cushion potentially reduces the benefits provided by the mattress/seat cushion and should be avoided or kept to a minimum. As part of sensible pressure area care, it is advisable to avoid wearing clothing which may cause areas of localised high pressure due to creases, seams, etc. Placing objects in pockets should be avoided for the same reason.
- Keep the pump away from sources of liquids and do not immerse in water.
- Do not expose the system, especially the mattress/seat, to naked flames, such as cigarettes etc.
- Do not store the system in direct sunlight.
- Switch off the electrical supply to the pump by disconnecting the pump from the mains socket before cleaning and inspection.
- Do not use hypercarbonate or phenolic based cleaning solutions.
- Ensure the system is clean and dry prior to use or storage.
- Never use sharp objects or electrically heated under blankets on or under the system.
- Store the pump and mattress/seat in the protective bags supplied.
- Only the pump and mattress/seat combination as indicated by Huntleigh Healthcare should be used. The correct function of the product cannot be guaranteed if the incorrect pump and mattress/seat combinations are used.

### Caution

**Electromagnetic compatibility (EMC). This product complies with the requirements of applicable EMC Standards. The use of accessories not specified by the manufacturer may result in increased emissions by, or decreased immunity of, the equipment, affecting its performance**

---

# 1. Introduction

---

**About this Manual** This manual is your introduction to the **Auto Logic™** Dual Mode support systems and the **Aura Logic™** seat cushion. Use it to initially set up the mattress or seat cushion, keep it as a reference for day-to-day routines and as a guide to maintenance.

**About Auto Logic™** The **Auto Logic** systems comprise of a mattress replacement, overlay or seat cushion, all operated by the same pump. The pump incorporates Self Set Technology (SST), which adjusts air pressure every 10 mins for the alternating mode and 20 mins for the Constant Low Pressure (CLP) mode to suit the Body Mass Index (BMI) and position of the patient. Both support systems can be used on standard hospital and domestic beds.

**Auto Logic Pump** The **Auto Logic** pump comprises of a moulded case with non slip feet on the base and rear and integral hanging brackets.

The controls are situated on the top of the pump and a sophisticated alarm system differentiates between normal operation and genuine system faults. If an alarm situation is detected an indicator will illuminate on the top and front of the pump and an audible warning will sound.

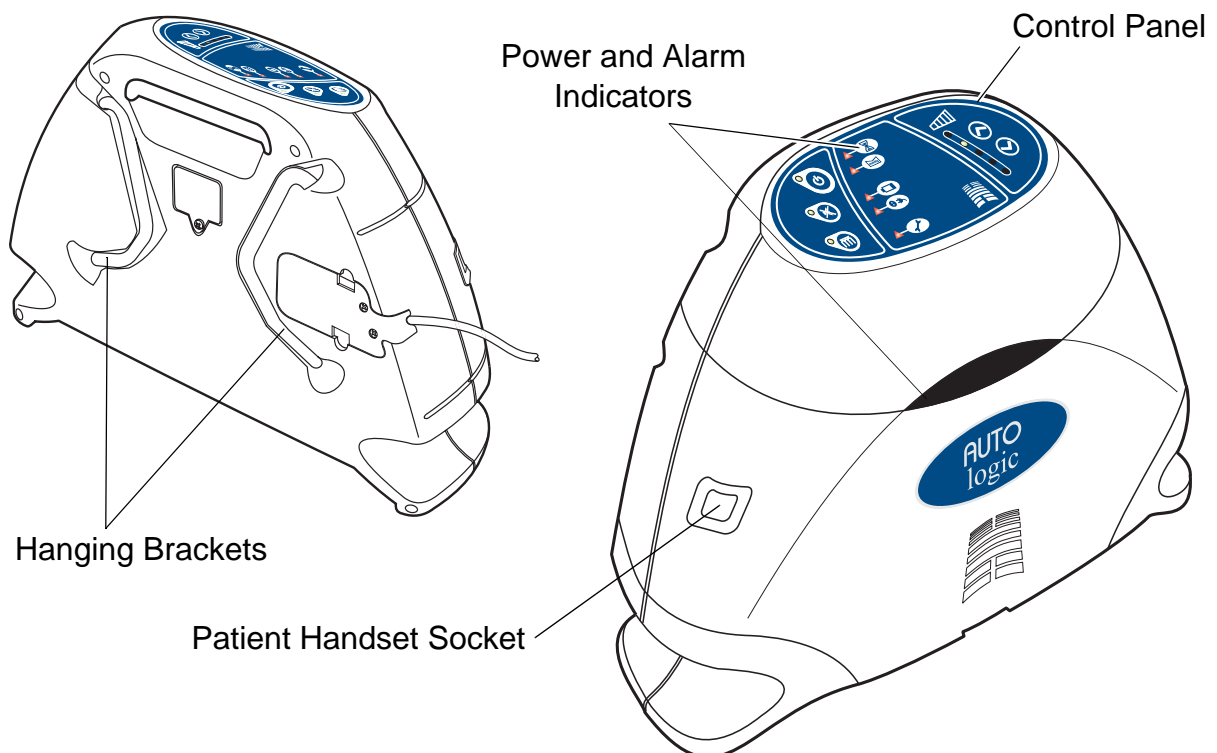

## **Auto Logic 110 Mattress Overlay**

The **Auto Logic 110** mattress overlay comprises the following components:

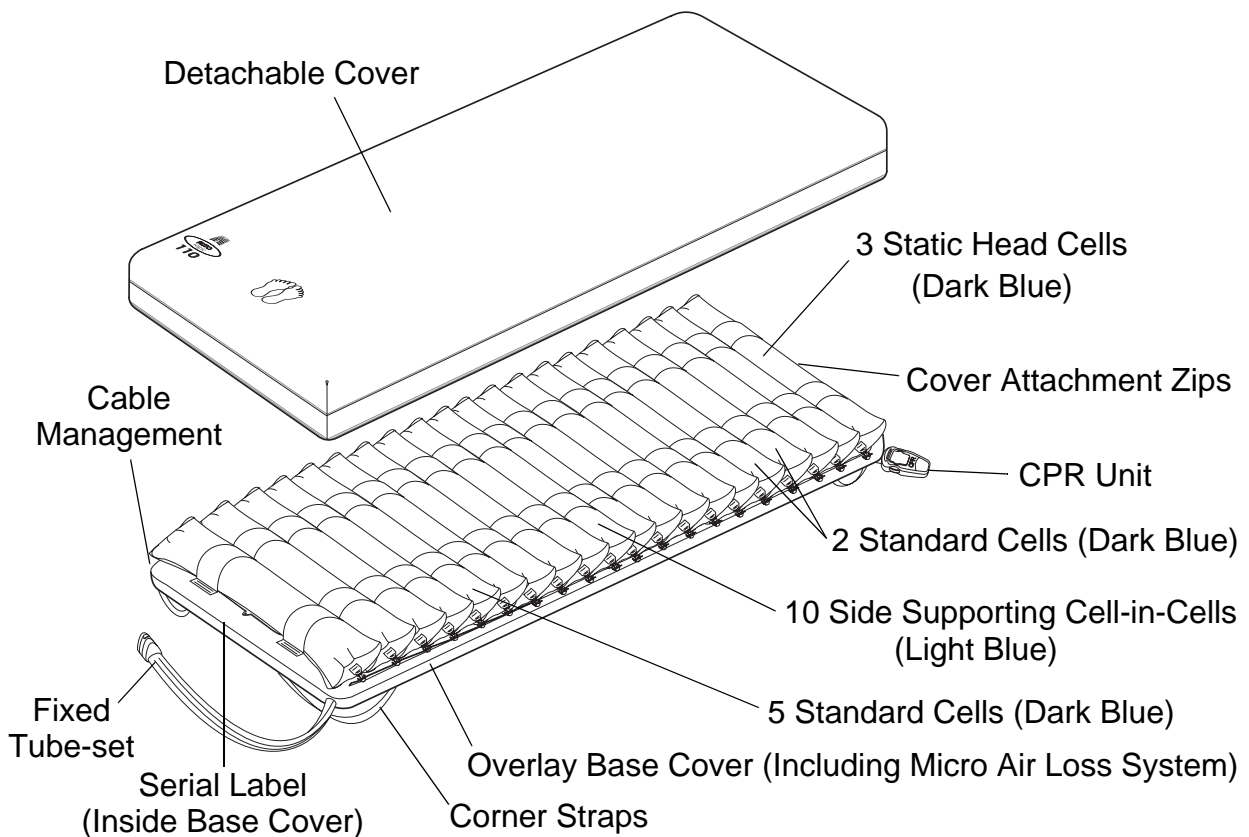

**Detachable Cover** The standard cover comprises of a 2-way stretch PU coated knitted fabric zipped to a durable nylon base. The zips are protected by flaps to prevent ingress of contaminants and allow easy removal of the cover for cleaning.

Alternative covers with advanced properties, such as Advantex<sup>®</sup> and eVENT<sup>®</sup>, are also available (Refer to “Cover options and features” on page 31).

**Cells** The mattress comprises of 20 polyurethane (PU) cells providing support to the user in either Alternating or Constant Low Pressure modes. The cells are slightly curved to reduce patient movement down the mattress.

The side supporting cells incorporate Cell-in-Cell technology to help the transfer of patients on and off the bed by keeping the edges of the mattress firm.

**Micro Air Loss System** A micro air loss system is incorporated into the base cover which de-humidifies the air surrounding the cells to reduce heat build up within the mattress and ensure patient comfort. This system is separate from the cell



inflation to enable both micro air loss and patient transport modes to be incorporated into the mattress.

**CPR function** A CPR (Cardio-Pulmonary Resuscitation) control is positioned at the head end of the mattress to allow the air to be evacuated in under 10 seconds.

**Tube-set** The tube-set has a 3-way pneumatic connection which incorporates a flexible, compact anti-kink tube that is resistant to crushing and any subsequent obstruction of air flow.

**If the tube-set is disconnected from the pump, the mattress automatically changes to transport mode.**

**Overlay Base Cover** The base cover for the mattress overlay is PU coated nylon on the underside. Four corner retention straps are incorporated, which slide under the corners of the base mattress.

### ***Auto Logic 200 Mattress Replacement***

The **Auto Logic 175 & 200** mattress replacements are of a similar construction to the overlay with the addition of a non-slip base. Within the non-slip base, the 175 mattress includes a foam underlay and the 200 mattress has an air filled zoned sub-mattress both of which replace the need for a mattress on the bed. The base can be removed to convert the mattress replacement to an

overlay, see your Huntleigh representative for more information.

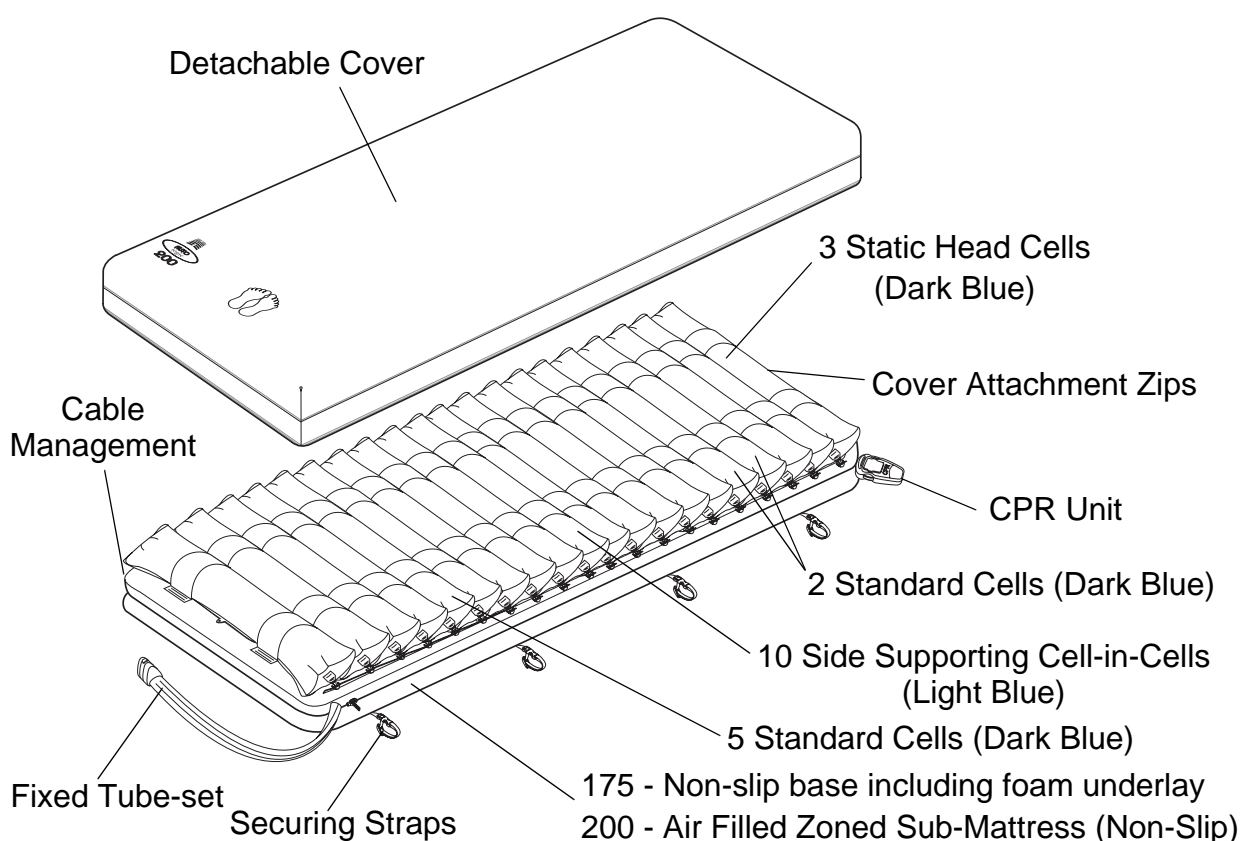

***Air Sub-Mattress  
(200 Only)***

The Sub-Mattress provides an integral constant pressure support which removes the need for a standard mattress. The pressure in the central zone of the pad is automatically adjusted in line with the Alternating / Constant Low Pressure (CLP) of the mattress. The pressure in the perimeter zone of the pad is maintained at a higher level to help transfer of patients on and off the bed.

On the underside of the Sub-Mattress there are eight straps to attach the mattress replacement to the bed frame. The straps can be moved to any of the 10 anchor points to allow attachment of the mattress to different bed frames.

***Aura Logic Seat Cushion***

The **Aura Logic** seat cushion comprises of a pressure relieving alternating cell system and can be used on standard hospital and normal domestic chairs.

The seat cushion can be operated using any of the **Logic** pumps. The pumps automatically recognises which

system has been connected and adjusts the pressure accordingly.

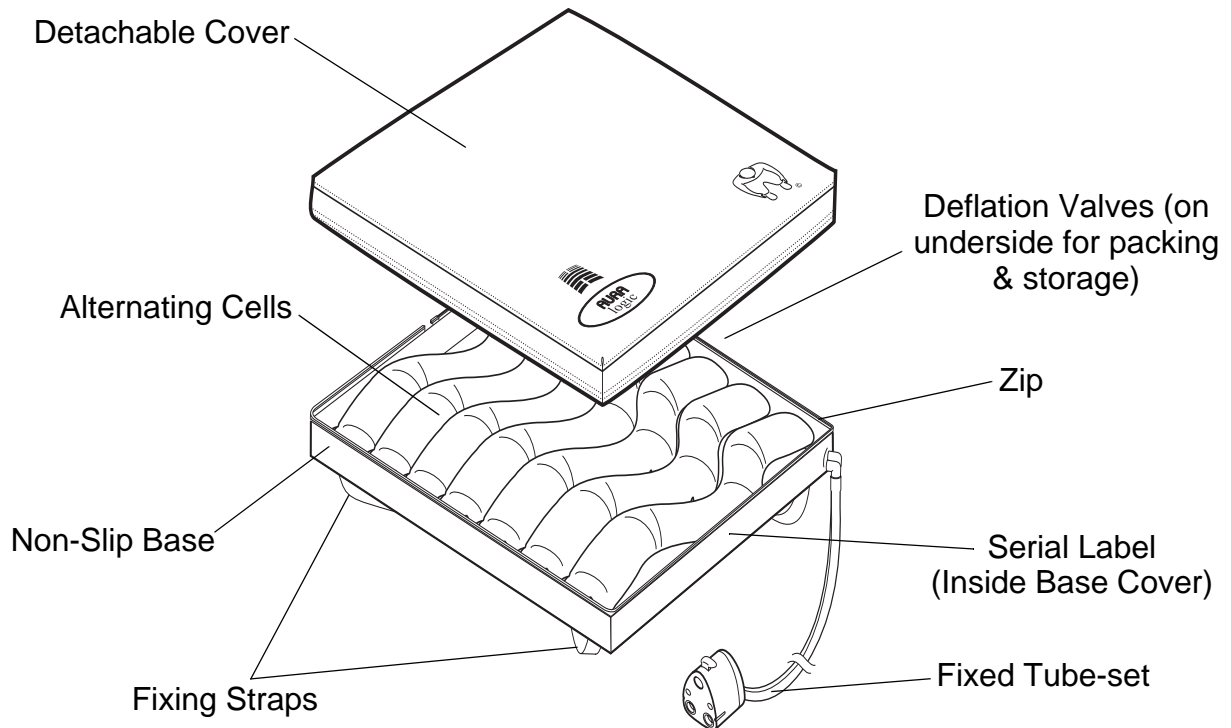

**Battery Pack (Optional)**

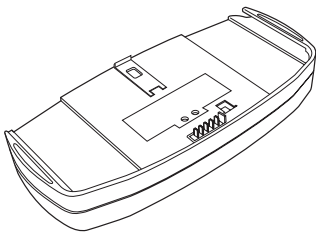

The Battery Pack is an optional extra and allows the pump to operate for a minimum of 8 hours without a mains power supply.

The Battery Pack easily slides onto the base of the pump and will recharge itself when the pump is operating from the mains power supply.

**Patient Handset (Optional)**

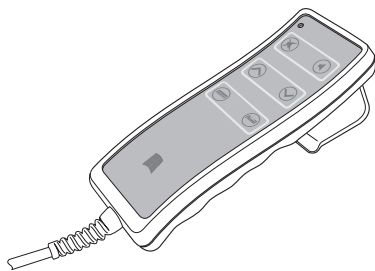

The Patient Handset is an optional extra and gives the patient control over the comfort settings of the mattress and also enables the patient to mute the alarm.

---

## 2. Clinical Applications

---

**Indications** The **Auto Logic** systems are indicated for patients weighing up to 180 kgs (28 stones) and are suitable for the prevention of pressure ulcers and management of pressure ulcers (Grade 1, 2 & 3 EPUAP 1999)<sup>1</sup>.

The **Auto Logic** systems may be used for patients with severe pressure ulcers (Grade 4) with frequent monitoring and repositioning.

The **Aura Logic** seat cushion is indicated for patients weighing up to 180 kgs (28 stones) and is suitable for the prevention and management of all grades of pressure ulcers.

**Contra-Indications** The **Auto Logic** systems in both alternating and Constant Low Pressure modes should not be used for patients with unstable spinal fractures.

In the case of patients with other unstable fractures, where a moving surface can be harmful, advice should be obtained from the appropriate physician before using the **Auto Logic** system in either mode.

The **Aura Logic** seat system should not be used for patients with poor sitting balance.

 *The **Auto Logic** systems and **Aura Logic** seat cushion are an aid to the prevention and management of pressure ulcers. If there is no improvement in the patient's condition, clinical advice should be sought.*

*The above are guidelines only and should not replace clinical judgement or experience.*

1. European Pressure Ulcer Advisory Panel (1999), *Guidelines on Treatment of Pressure Ulcers EPUAP Review 1(2):31-33.*

---

## 3. Installation

---

### Preparing the Auto Logic systems for use

The system is very simple to set up using the following guidelines:

1. Remove the system from the packaging. You should have the following items:
  - **Auto Logic** pump including mains power cord and hanging brackets.
  - Either the **Auto Logic 110** mattress overlay, the **Auto Logic 200** mattress replacement or the **Aura Logic** seat cushion, which all have integral tube-sets.
  - Cover.
  - Patient Handset (optional).
  - Battery Pack (optional).

### Installing the Auto Logic 110, 175 or the 200 Mattress

***Auto Logic 110  
Mattress Overlay*** If you have the **Auto Logic 110** mattress overlay system, it should be installed as follows:

1. Place the overlay on top of the base mattress, with the tube-set located near the foot end of the bed and the CPR at the head end. The cells of the mattress must be uppermost.

#### **Caution**

**Do not use the Auto Logic 110 mattress overlay directly on the bed frame.**

2. Secure the overlay to the base mattress by placing and tightening the four long straps under the corners of the base mattress.

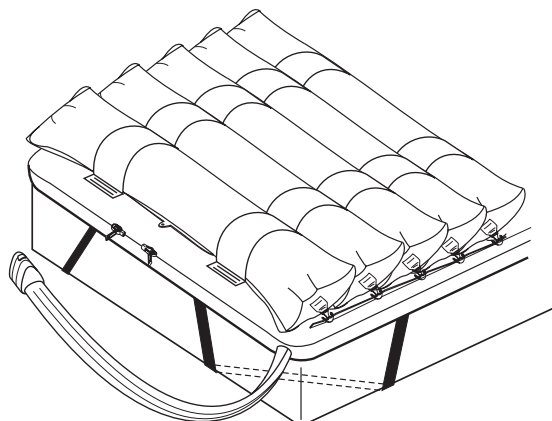

### ***Auto Logic 175 or 200 Mattress Replacement***

If you have the **Auto Logic 175 or 200** mattress replacement system, it should be installed as follows:

1. Remove the existing mattress from the bed frame and check that there are no protruding bed springs or sharp objects on the bed frame surface.
2. Unroll the mattress onto the bed frame and ensure that the tube-set is located near the foot end of the bed and the CPR at the head end. The cells of the mattress must be uppermost.
3. Attach the mattress to the bed frame using the 8 fastener straps.

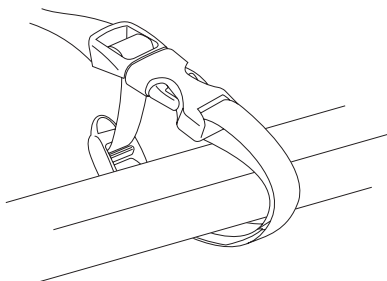

 *The 8 fastener straps can be moved to any of the 10 anchor points on the base of the mattress replacement. This allows for attaching the mattress to different types of bed frame.*

*If the bed can be profiled to any position (i.e. raised or lowered), attach the mattress to the movable parts of the bed only.*

### To Complete the Mattress Installation

Complete the installation of the mattress overlay or the mattress replacement as follows:

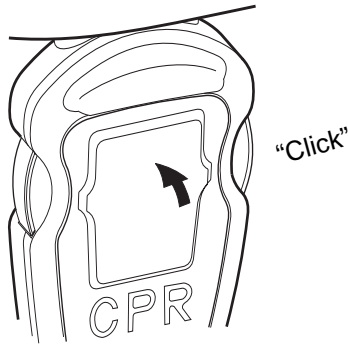

1. If not already fitted, place the protective cover over the mattress. Ensure that the Huntleigh logo is uppermost and at the foot end of the mattress.
2. Zip the cover onto the mattress starting from the head end and taking care not to trap any material in the zip.
3. Ensure that the CPR unit is clicked into the closed position.

 *The CPR must be accessible at all times.*

#### **WARNING**

**Make sure that the mains power cable is positioned to avoid causing a hazard and is clear of moving bed mechanisms or other possible entrapment areas. Refer to “Cable Management” on page 11.**

## Installing the Pump

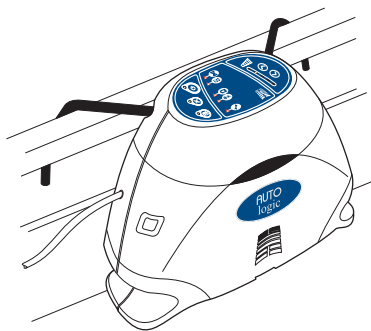

The pump should be installed as follows:

1. Position the pump, feet down, on any convenient horizontal surface or alternatively suspend from the bed foot rail by means of the swing out hooks.
2. Ensure that the mattress/seat tube-set is not "kinked" or twisted and connect it to the pump until it clicks into place. Ensure that the tube-set is securely connected to the pump.
3. Insert the mains power plug into a suitable mains power socket.

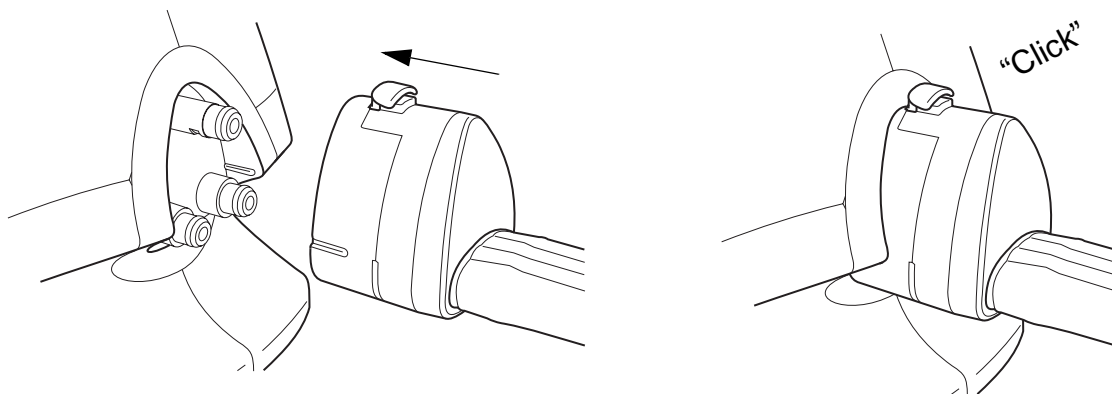

### **Battery Pack**

If you have a battery pack, refer to "Installing the Battery Pack" on page 20.

### **Patient Handset**

If you have a Patient Handset, refer to "Installing the Patient Handset" on page 20.



### **Cable Management**

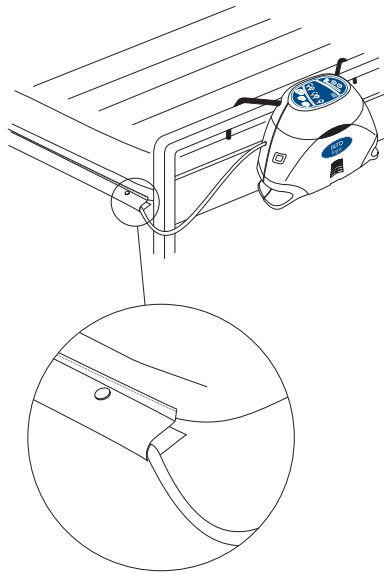

If using the mattress replacement or mattress overlay, the power cable can be positioned in the cable management flap running down the side of the mattress as follows:

1. Locate the flap running along the mattress on the opposite side to the tubeset and CPR.
2. Run the straight part of the cable along the side of the mattress securing the flap round the cable using the press studs.

### **System Operation**

The system is now ready for use. Refer to “Controls, Alarms and Indicators” on page 14 and “Operation” on page 16 for day-to-day operating instructions.

## Installing the Aura Logic Seat cushion

The system should be installed as follows:

1. Check that there are no sharp objects on the chair which may puncture the cushion.
2. Place the cushion on top of the chair surface. From a standing position in front of the chair and facing it, ensure that:
  - The cells are uppermost.
  - The tube-set appears from the front right corner of the cushion.
  - The cells in the seat cushion are in a horizontal position across the chair, with the 'V' shape pointing towards the front.

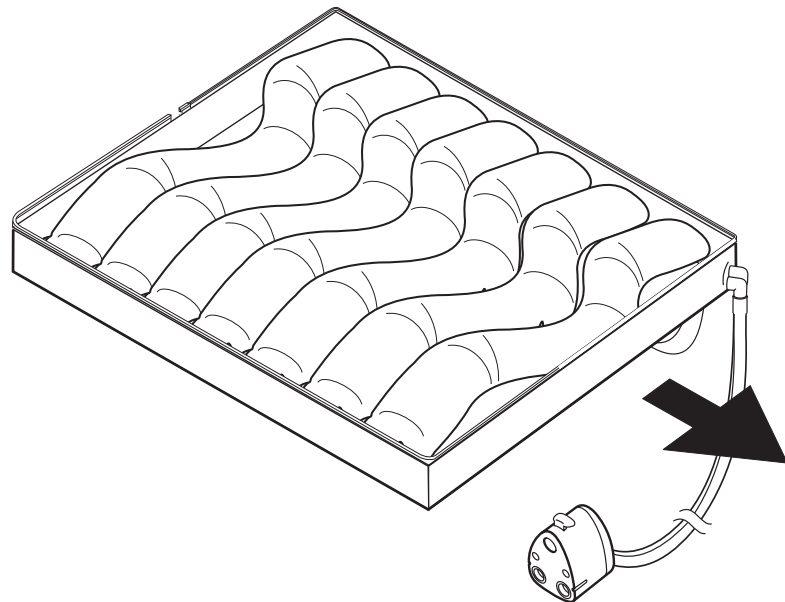

### Cautions

- Do not use the Aura Logic seat cushion without a foam cushion beneath it.
- Always use the Aura Logic seat cushion with the protective top cover.
- Always use the Aura Logic seat cushion in the correct orientation.
- Avoid trailing cables - ensure that cables and tubing are positioned beneath the chair to avoid causing a hazard.

3. Secure the seat cushion to the chair by using the fixing straps as shown in the following illustrations.

4. If the chair is of the open sided construction, then fix the cushion as shown below:

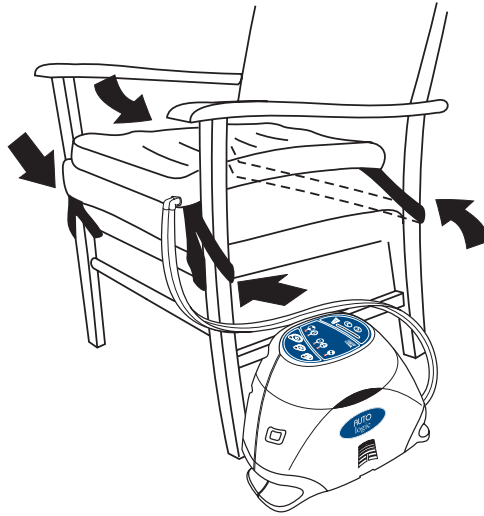

5. If the chair is of the closed side type with a removable seat cushion, fix the seat cushion as shown below:

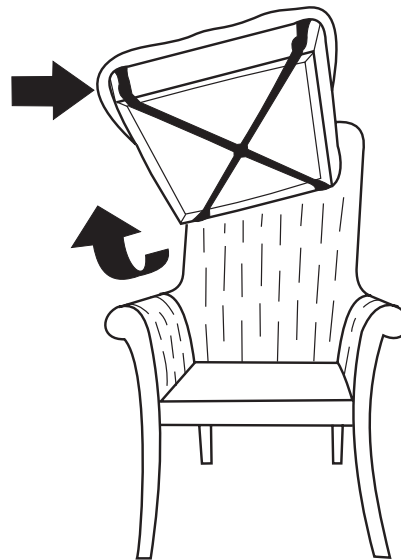

6. If the chair is of the closed side type with a non-removable seat cushion, then security will rely on the anti-slip base material of the seat cushion.
7. Place the protective cover over the seat cushion and ensure that the Huntleigh H and the orientation icon, printed on the cover, are uppermost and at the front of the seat.
8. Zip the cover onto the seat cushion, taking care not to trap any material in the zip.
9. Connect to the **Auto Logic** pump, refer to page 10.

---

## 4. Controls, Alarms and Indicators

---

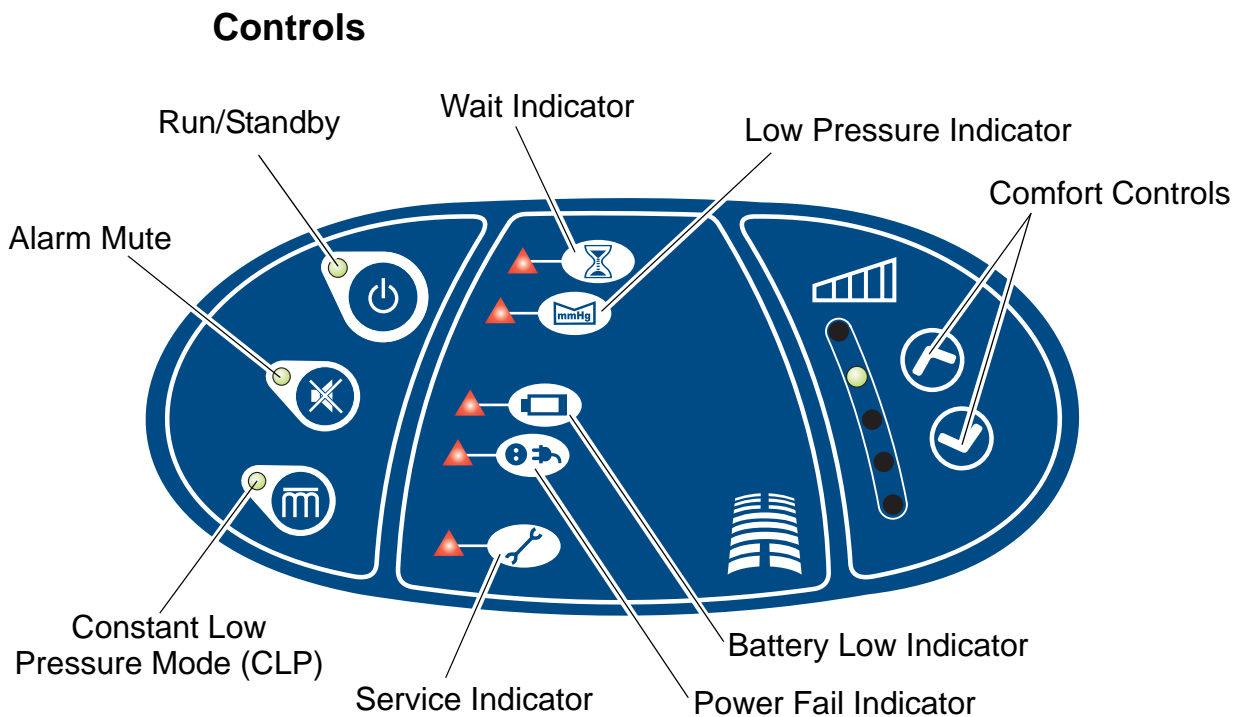

### **Run/Standby Button**



Pressing the Run/Standby button will activate the pump. The green indicators on the control panel and the front of the pump will illuminate when the pump is on.

To switch the pump to Standby, the button must be pushed for 2 seconds. This prevents accidental operation.

### **Alarm Mute**



During an alarm condition (except Power Fail Alarm), the sound of the alarm can be muted by pressing this button. The yellow indicator will then remain on but the alarms will be muted for 15 minutes or until the alarm condition has been corrected.

This can be controlled using the Patient Handset (optional).

### **Constant Low Pressure (CLP) Mode**



Selects the Constant Low Pressure (CLP), non-alternating mode. The orange indicator will illuminate when the pump is in this mode.

When the alternating mode (default) is selected, the orange indicator will be switched off.

### **Comfort Control**



Two buttons control the relative firmness/softness of the mattress/seat cushion for patient comfort.

The pressure setting is indicated by the yellow indicator to the left of the buttons.

This can also be adjusted using the Patient Handset (optional).

## **Alarms and Indicators**

### **Wait Indicator**



The yellow **Wait** indicator is illuminated when the mattress/seat is being inflated. The indicator will remain illuminated until the mattress/seat has been fully inflated.

### **Low Pressure Indicator**



The red **Low Pressure** indicator is illuminated whenever the pump detects low pressure within the mattress/seat. An audible alarm will sound unless cancelled by the **mute** button.

The indicator will extinguish once normal pressure is reached.

 See “Troubleshooting” on page 26 for possible causes of **Low Pressure**.

### **Battery Low Indicator**



The yellow **Battery Low** indicator will illuminate 2 hours before battery failure.

1 hour before battery failure, the pump will default to Constant Low Pressure (CLP) mode, an audible alarm will sound and the yellow indicator will flash.

### **Power Fail Indicator**



The red **Power Fail** indicator will illuminate when a mains power failure has been detected and no battery backup is available. An audible alarm will sound until power is resumed or the pump is switched off using the **run/standby** button.

If a **Power Fail** condition arises and no battery is connected, disconnect the tubeset from the pump. This will put the mattress into transport mode (Refer to page 17).

### **Service Indicator**



The yellow **Service** indicator will illuminate and remain on after a set number of running hours. This indicates that the pump is ready for a service. The pump will continue to function normally even when the service indicator is illuminated.

If the yellow **Service** indicator flashes, the pump has detected an internal fault and a Service Engineer should be called.

---

## 5. Operation

---

These instructions cover day-to-day operation of the system. Other operations, such as maintenance and repair, should only be carried out by suitably qualified personnel.

**Quick Start** Before using any of the **Auto Logic** mattress or seat systems make sure it has been installed correctly in accordance with “Installation” on page 7 and ensure that the CPR unit on the mattress is clicked into the closed position.

Run/Standby

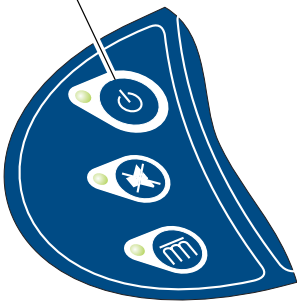

1. When the **Auto Logic** pump is switched on at the mains supply or a battery pack is connected, an audible beep will sound and a self-diagnostic check will run for approximately 10 seconds. When the check is complete a second audible beep will sound and the pump is ready for use.
2. Press the **Run/Standby** button on the control panel of the pump. The **Run/Standby** and **Wait** indicators will illuminate together with the comfort indicator and the green light on the front of the pump.
3. Allow approximately 7 minutes for the mattress overlay, 15 minutes for the mattress replacement or 2-3 minutes for the seat to inflate fully.

 *The amber Wait indicator will go off once the mattress/seat is fully inflated.*

4. Place a bed sheet over the mattress and tuck in loosely. Ensure that the CPR unit is clearly visible at the head end of the bed.

 *Once the patient is on the mattress, the pump will automatically sense and adjust the pressure in the cells using Self Set Technology (SST) to support the patient.*

**Comfort Control** The mattress/seat cell pressure can be manually adjusted for patient comfort using the buttons on the pump control panel.

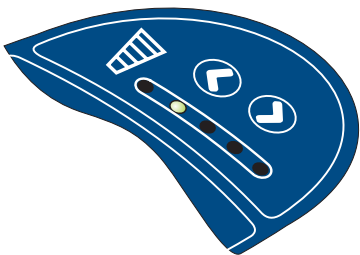

This can also be adjusted using the comfort control buttons on the Patient Handset panel (optional).

## Power Fail Condition

If a **Power Fail** condition arises and no battery is connected, disconnect the tubeset from the pump. This will put the mattress into transport mode and will support the patient for up to 12 hours. Once power is resumed, re-connect the tubeset to the pump.

## To Disconnect the Tube-set

To disconnect the tube-set at any time, push the button down and pull the tube-set connector away from the pump.

This will put the mattress into Transport Mode and will not deflate the mattress. To deflate the mattress Refer to page 18.

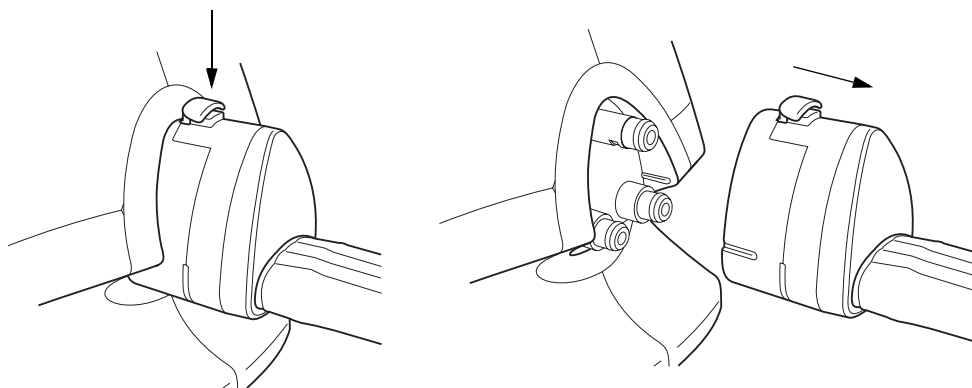

## Transport Mode



To transport a patient using the **Auto Logic** mattress, disconnect the tube-set from the pump. This will automatically switch the mattress into transport mode.

The patient will remain supported by the mattress for up to 12 hours.

To resume normal operation, simply reconnect the tube-set and run the pump.

## To Deflate and Store the Auto Logic Mattress

- To deflate the mattress:**
1. Disconnect the tube-set from the pump.
  2. Activate the CPR control to deflate the mattress.

**To store the mattress** Following deflation:

1. Bring the tubeset over the mattress to lie parallel to the foot end of the mattress.
2. Roll the mattress from the foot end toward the CPR connector at the head end of the mattress.

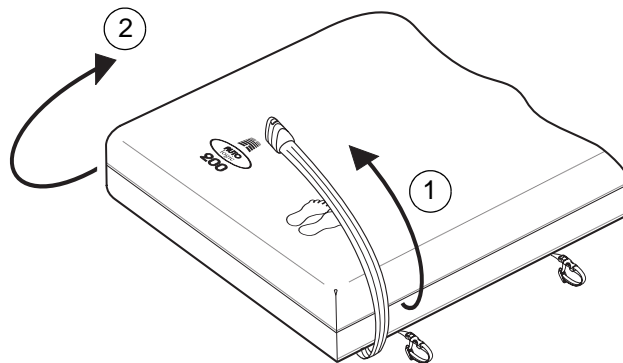

## To Deflate the Aura Logic Seat Cushion

To deflate the seat cushion:

1. Disconnect the tube-set from the pump.
2. Depress the 2 valves on the underside of the seat cushion.

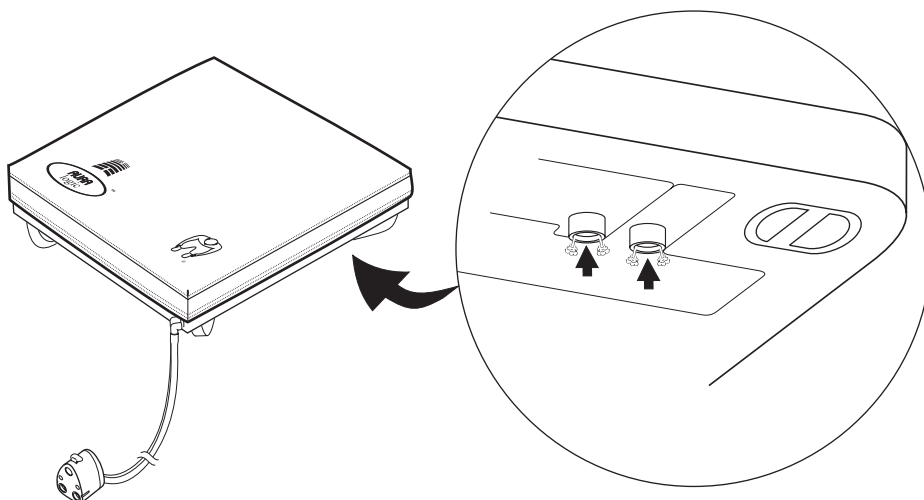



## CPR Control

### IMPORTANT IN THE EVENT OF CARDIAC ARREST

In the event of a patient suffering cardiac arrest and CPR needing to be administered:

**To activate CPR** Press the two CPR release buttons simultaneously.

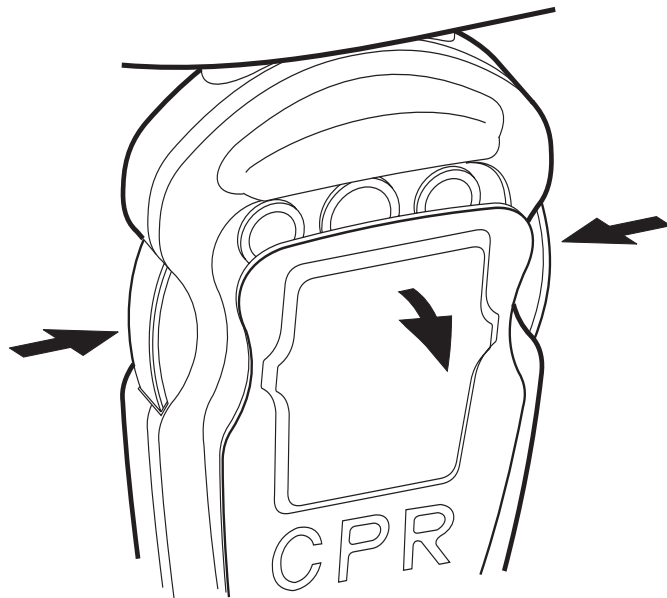

**To reset CPR** Push the front of the CPR unit until it clicks into place.

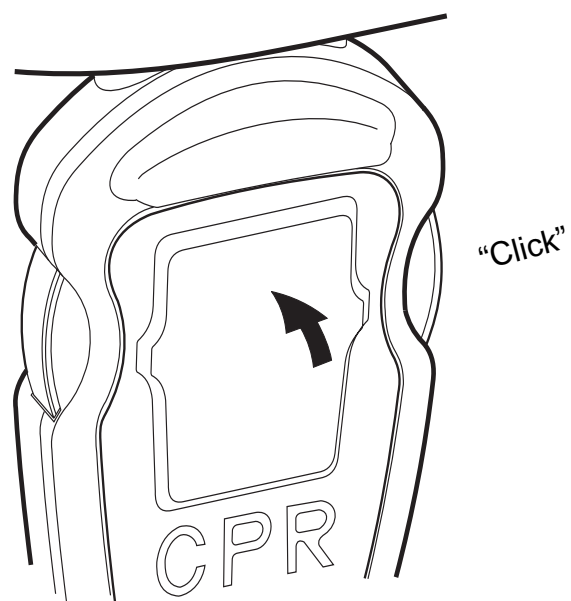

---

## 6. Patient Handset and Battery Pack

---

### Installing the Patient Handset

If you have a Patient Handset for the pump, install it as follows:

1. Connect the Patient Handset into the socket on the side of the pump.
2. Hang the Patient Handset on the bed frame within easy reach of the patient.

 *The Patient Handset can be used to control the comfort setting and to mute the alarm.*

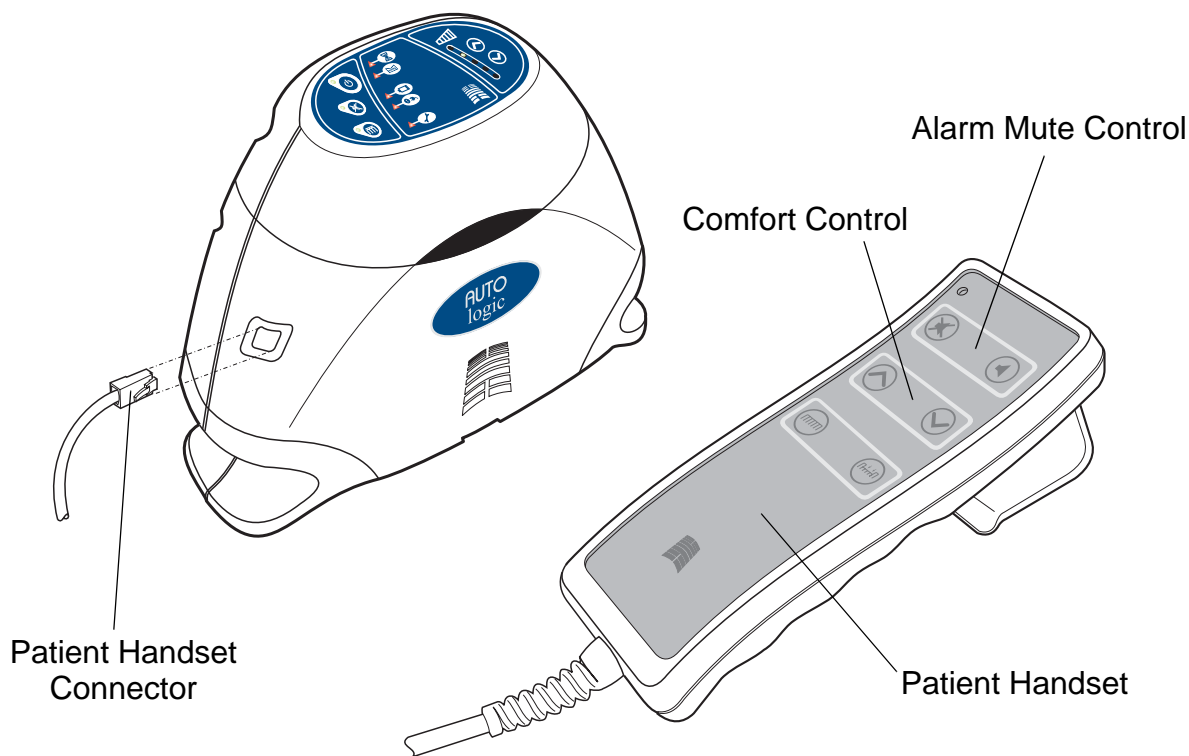

### Installing the Battery Pack

Install the battery pack to the pump as follows:

1. Remove the battery socket cover from the base of the pump.
2. From the front of the pump, slide the battery pack over the guides on the base of the pump and click into place.

3. To remove the battery pack, depress the reset/status latch at the rear of the unit and slide the battery pack out from the base of the pump. Replace the battery socket cover on the base of the pump.

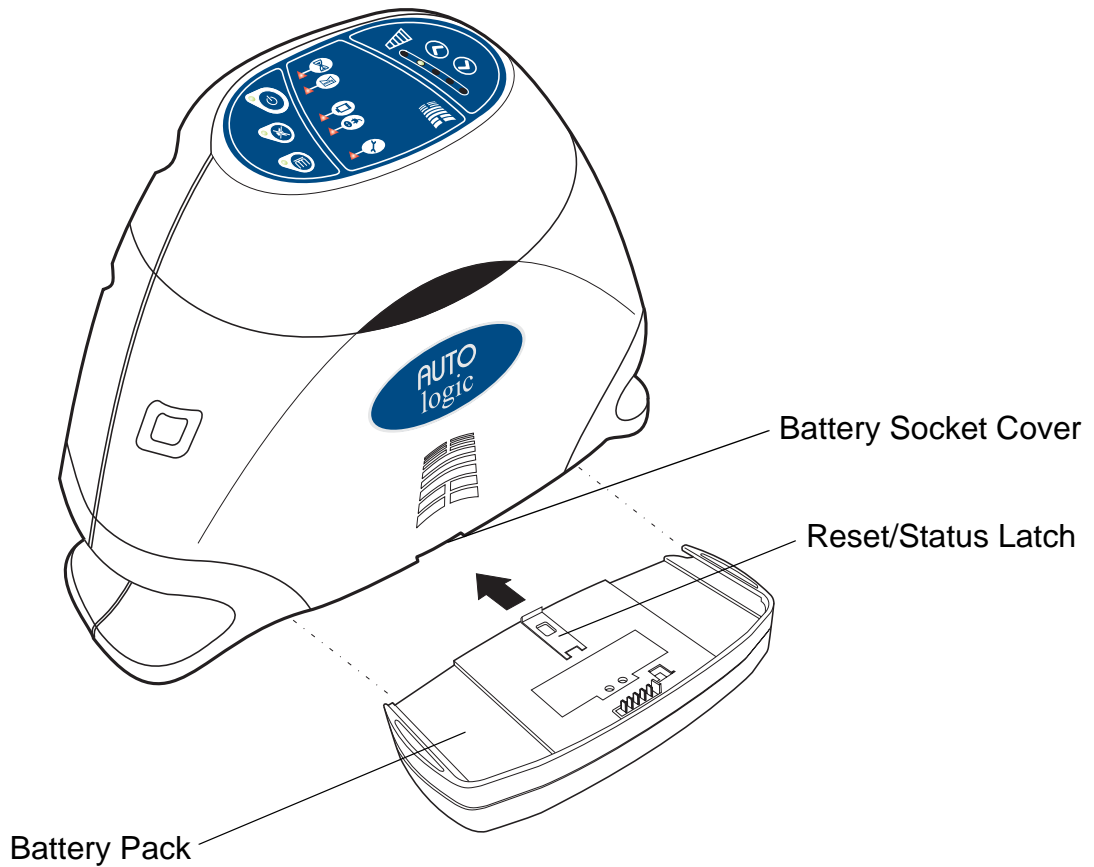

### **Battery Storage and Disposal**

If the device is not to be used for an extended period, remove and store the battery pack. If the battery packs are to be put into long term storage they should be recharged at least once every 3-6 months. Faulty battery packs should be sent back to a Huntleigh service centre for recycling.

# Checking the Status of the Battery Pack

## Battery Label

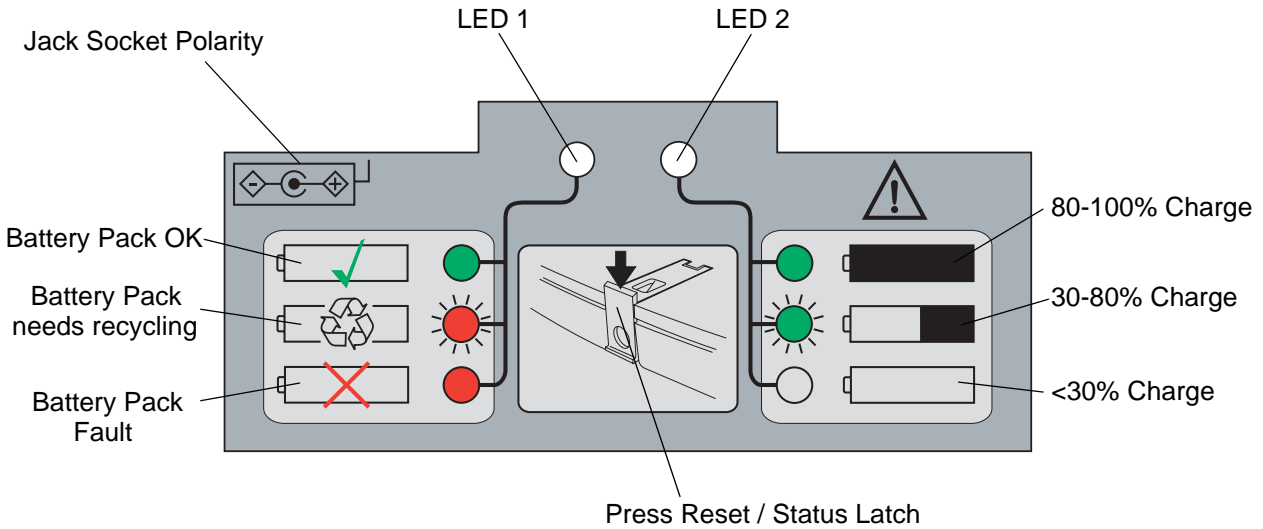

### To check the battery pack status

To check the status of the battery pack:

1. Remove the battery pack from the pump unit.
2. Press the Reset/Status Latch, this will activate the 2 LEDs on the top of the battery.

If the battery pack is not on charge the LEDs will display one of the following conditions:

LED 1	LED 2	Battery Status
Green ●	Green ●	The Battery Pack is OK. It has > 80% charge.
Green ●	Green ●☀	The Battery Pack is OK. It has between 30-80% charge.
Green ●	○	The Battery Pack is OK. It has < 30% charge.
Red ●☀	Green ●☀	The Battery Pack needs recycling*. It has between 30-80% charge.
Red ●☀	○	The Battery Pack needs recycling*. It has < 30% charge.
Red ●	○	The Battery Pack has an error.
○	○	The Battery Pack is flat or has an error. Try recharging.

If the battery pack is on charge, via the optional battery charger, the LEDs will display one of the following conditions:

LED 1	LED 2	Battery Status
Green ●	Green ●	The Battery Pack is OK. It is fully charged.
○	Green ●	The Battery Pack is charging.
Red ●	Green ●	The Battery Pack needs recycling*. The Battery is charging.
Red ●	○	The Battery has an error. This could be a temporary fault due to adverse operating temperature.
○	○	The Battery has an error.

\* Once the battery pack has entered the ‘recycling’ mode it will never show that the battery is fully charged (Note: This does not indicate a fault condition).

### Charging the Battery Pack

The battery pack is automatically recharged whenever it is connected to a pump which is connected to an AC outlet. Alternatively the battery pack can be recharged away from the pump by plugging into the battery charger as shown below.

 *It is normal for the battery pack and charger to get warm during use. Avoid charging the battery near source of heat or in direct sunlight.*

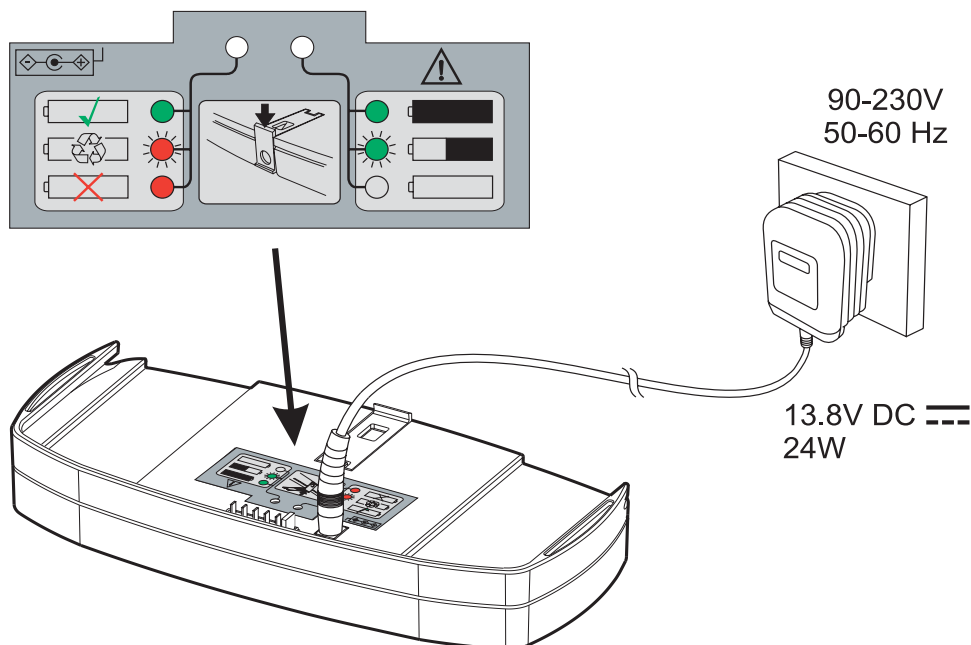

To ensure the long term performance of the battery pack, periodically run the pump using the battery pack until the pump switches off. This will fully discharge the battery pack. Fully recharge the battery pack before further use.

---

## 7. Decontamination

---

The following guidelines have been established in accordance with good infection control practice. Should you have any questions regarding cleaning or if you require further information please contact our service centre.

### Caution

**Gloves and protective clothing should always be worn when carrying out decontamination procedures.**

### WARNING

**Switch off the electrical supply to the pump and disconnect the power cord from the mains supply before cleaning and inspection.**

### During Use

**To clean** The mattress, seat cushion, pump, tube-set and other ancillary parts should be cleaned weekly and in between each patient use using a disposable cloth soaked in mild detergent and warm water. Do not use abrasive compounds or pads. The user should avoid immersing electrical parts in water during the cleaning process.

**To disinfect** All parts can be wiped down with sodium hypochlorite or NaDCC solution at 1000ppm of available chlorine following the cleaning procedure.

Using other disinfectants may cause damage to the products. If you wish to use disinfectants recommended in local infection control guidelines, please contact your Huntleigh Healthcare representative.

Do not use Phenol or Quarternary Ammonium Compound (QAC) based cleaning solutions as these will damage the surface coating.

**Laundering** The mattress/seat top covers can be easily unzipped for complete removal to allow laundering at 65°C for 10 minutes or 80°C for 3 minutes to achieve thermal disinfection. This complies with HSG (95) 18 Hospital Laundry arrangements for used and infected linen (UK) 1995.

**DO NOT TUMBLE DRY COVERS ABOVE 50°C.**

**Further Information** For further detailed decontamination guidance, consult Huntleigh Healthcare Infection Control Procedures - Policy Guidelines.

---

## 8. Routine Maintenance

---

### Auto Logic System

**Maintenance** The equipment has been designed to be virtually maintenance-free between service periods.

**Servicing** Huntleigh Healthcare will make available on request service manuals, component parts lists and other information necessary for Huntleigh Healthcare trained personnel to repair the system.

### Auto Logic Pump

**General Care, Maintenance and Inspection** Check all electrical connections and power cord for signs of excessive wear.

In the event of the pump being subjected to abnormal treatment, e.g. immersed in water or dropped, the unit must be returned to an authorised service centre.

### Auto Logic 110, 175 & 200 and Aura Logic Seat Cushion

**General Care** Remove the top cover and inspect for signs of wear or any tears.

Check all zips are secure.

Check integrity of all connectors, including cell to manifold connections.

Ensure all cell fasteners are correctly connected to the mattress base sheet and are not loose or damaged.

### Serial Labels

**Pump** The serial number for the pump is on the label on the back of the pump case.

**Mattress** The mattress serial label can be found just inside the base cover above the tubeset, refer to the illustration on page 2.

**Seat Cushion** The seat cushion serial label can be found just inside the front of the base cover, refer to the illustration on page 4.

## 9. Troubleshooting

The following table provides a troubleshooting guide for the **Auto Logic** and **Aura Logic** systems in the event of malfunction.

Indicator	Possible Cause	Remedy
<b>LOW PRESSURE</b> and <b>WAIT</b>	<p>The pump is inflating the mattress/seat.</p> <p>CPR not fully closed.</p>	<p>Both indicators will extinguish when operating pressure is reached.</p> <p>Close CPR unit.</p>
<b>LOW PRESSURE</b>	<p>The tube-set is not connected properly.</p> <p>CPR not fully closed.</p> <p>There is a leak in the system.</p>	<p>Check the tube-set connector and ensure it is securely fitted to the pump.</p> <p>Close CPR unit.</p> <p>Call service engineer.</p>
<b>POWER FAILURE</b>	<p>Power has been removed from the pump.</p>	<p>Re-apply power or switch the pump off.</p> <p>If the fully charged battery pack is fitted the pump will continue to operate for a minimum of 8 hours.</p>
<b>BATTERY LOW</b>	<p>Low battery life.</p>	<p>Install a fully charged battery pack.</p> <p>Charge the battery by using mains power supply to run the pump.</p>
<b>SERVICE (ON)</b>	<p>Pump needs a service.</p>	<p>Call service engineer.</p> <p>To find the serial numbers for the pump, mattress or seat refer to "Serial Labels" on page 25.</p>
<b>SERVICE (FLASHING)</b>	<p>Pump has detected an internal fault.</p>	<p>Switch the pump off and call service engineer.</p>



---

## 10. Warranty and Service

---

Huntleigh Healthcare's standard terms and conditions apply to all sales. A copy is available on request. These contain full details of warranty terms and do not limit the statutory right of the consumer.

Huntleigh Healthcare recommend that the **Auto Logic** and **Aura Logic** systems should be serviced every 2 years.

For service, maintenance and any questions regarding this, or any other Huntleigh Healthcare product, please contact:

Huntleigh Healthcare Ltd  
310-312 Dallow Road  
Luton  
Bedfordshire, LU1 1TD

Tel : +44 (0) 1582 413104  
Fax : +44 (0) 1582 459100

---

## 11. Technical Description

---

**Auto Logic Pump      630001**

Supply Voltage:      90-230 Vac

Supply Frequency:    50-60 Hz

Electrical Rating:    50 VA - Mains powered, no battery pack connected  
85 VA - Mains powered  
Battery pack connected (charging) 

Size:      Length:    375 mm

                Height:    280 mm

                Depth:    125 mm

Weight:                2.75 kg

Fuse ratings:            Plug:      5A to BS1362  
                                 Pump:      Internal Fuse T3.15 AH 250V

### UK and Euro Electrical Safety Standards

Complies with:            EN 60601-1:1990/A13:1996

Degree of protection    Class II, Type BF  
against electric shock:

Mode of operation:      Continuous  
                                 (Internally powered)

### Pump Symbols

 Alternating Current

 Type BF

 Double Insulated

 Refer to the User Manual

**SN:**      Serial Number

### Battery Pack              **BBP600**

Size:                      242 x 37 x 118 mm

Weight: 0.8 kg  
Electrical Rating: DC 13.8V 4Ah (NiMH)

### Battery Symbols



Do not dispose of in a dustbin (Recycle)



Recycle

### Environmental Conditions

#### ***Operating (Pump & Battery Pack)***

Temperature range: +10°C to +40°C  
Relative humidity: 30% to 75%  
Atmospheric pressure: 700hPa to 1060 hPa

#### ***Storage (Pump)***

Temperature range: -40°C to +70°C  
Relative humidity: 10% to 100% (non-condensing)  
Atmospheric pressure: 500 hPa to 1060 hPa

#### ***Storage (Battery Pack)***

Temperature range: -10°C to +30°C  
Relative humidity: 30% to 75%  
Atmospheric pressure: 500 hPa to 1060 hPa

***Environmental Protection:*** Please dispose of this unit in accordance with local regulations.

### **Auto Logic 110 mattress**

Height: 115 mm (4.5")  
Cell Material: Polyurethane

### **Auto Logic 175 mattress**

Height: 175 mm (7")  
Cell Material: Polyurethane  
Foam underlay size: 2032 x 838 x 63.5 mm (80"x 33" x 2.5")  
Base Material: PU Laminate

## Auto Logic 200 mattress

Height:	205 mm (8")
Cell Material:	Polyurethane
Air-filled sub-mattress size:	2030 x 860 x 90 mm (80"x 34" x 3.5")
Base Pad Material:	PU Laminate

## Mattress Size Information

Part No.	Description	Spare Cover	Length mm	Width mm
PXA001ADV	AUTO Logic 110 (Advantex)	PXA082	2030 (80")	860 (34")
PXA001DAR	AUTO Logic 110 (Dartex)	PXA080	2030 (80")	860 (34")
PXA001EVE	AUTO Logic 110 (eVENT)	PXA084	2030 (80")	860 (34")
PXA201ADV	AUTO Logic 110 Narrow (Advantex)	PXA282	2030 (80")	780 (30")
PXA201DAR	AUTO Logic 110 Narrow (Dartex)	PXA280	2030 (80")	780 (30")
PXA201EVE	AUTO Logic 110 Narrow (eVENT)	PXA284	2030 (80")	780 (30")
PXB001ADV	AUTO Logic 200 (Advantex)	PXB082	2030 (80")	860 (34")
PXB001DAR	AUTO Logic 200 (Dartex)	PXB080	2030 (80")	860 (34")
PXB001EVE	AUTO Logic 200 (eVENT)	PXB084	2030 (80")	860 (34")
PXB201ADV	AUTO Logic 200 Narrow (Advantex)	PXB282	2030 (80")	780 (30")
PXB201DAR	AUTO Logic 200 Narrow (Dartex)	PXB280	2030 (80")	780 (30")
PXB201EVE	AUTO Logic 200 Narrow (eVENT)	PXB284	2030 (80")	780 (30")
PXB005ADV	AUTO Logic 175 (Advantex)	PXB182	2030 (80")	860 (34")
PXB005DAR	AUTO Logic 175 (Dartex)	PXB180	2030 (80")	860 (34")
PXB005EVE	AUTO Logic 175 (eVENT)	PXB184	2030 (80")	860 (34")

## Cover options and features

<b>Feature</b>	<b>Standard Cover</b>	<b>Advantex™</b>	<b>eVENT® Fabric *</b>
Moisture vapour permeable	Yes	Yes	12 x higher
Air permeable	No	No	Yes
Low friction	Yes	18% lower	20% lower
Water resistant / repellent	Yes	Yes	Yes
Infection Control	Bacteriostatic, fungistatic, antimicrobial	Bacteriostatic, fungistatic, antimicrobial	INERT MATERIAL does not support bacterial growth
Fire retardant	BS 7175: 0,1 & 5	BS 7175: 0,1 & 5	BS EN ISO 12952-1 <b>ONLY</b>
2 way stretch	Yes	Some	No
Cleaning conditions	Removable cover, washable at 80°C	Removable cover, washable at 80°C	Removable cover, washable at 80°C
Life span	50 Wash Cycles	50 Wash Cycles	15 Wash Cycles
Application area	Acute and Homecare	Acute and Homecare	Acute ONLY
*Due to the inherently lower flame retardancy of the high performance eVENT® fabric, it is NOT suitable for use in the homecare environment.			

### **Aura Logic Seat Cushion PXS001**

Length: 470 mm

Width: 455 mm

Height: 50 mm

Cell Material: Polyurethane

## Cleaning Symbols

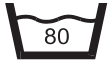

Wash at 80°C (176°F)



Do not iron



Do not use phenol or QAC based cleaning solutions



Do not tumble dry above 50°C.



Wipe surface with damp cloth



1000ppm  
NaOCl  
NaDCC

Use solution diluted to 1000 ppm

**United Kingdom****Huntleigh Healthcare Ltd**

310-312 Dallow Road, Luton  
Bedfordshire, LU1 1TD

**T:** +44 (0)1582 413104

**F:** +44 (0)1582 459100

**Australia****Huntleigh Healthcare Pty Limited**

PO Box 330  
Hamilton Hill  
Western Australia 6963

**T:** +61 8 9 337 4111

**F:** +61 8 9 337 9077

**België / Belgique / Belgien****Huntleigh Healthcare NV SA**

Evenbroekveld 6  
B-9420 Erpe-Mere

**T:** +32 (0) 53 60 73 80

**F:** +32 (0) 53 60 73 81

**Deutschland****HNE Healthcare GmbH**

Im Hülsenfeld 19  
D-40721 Hilden

**T:** +49 (0)2103/97 11-0

**F:** +49 (0)2103/97 11-80

**Danmark****Huntleigh Healthcare A/S**

Vassingerødvej 52  
DK-3540 Lyngø

**T:** +45 4 913 8486

**F:** +45 4 913 8487

**España****Huntleigh Healthcare SL**

Avda. de la Industria, 32-2<sup>a</sup>  
28108 - Alcobendas - Madrid

**T:** +34 902 108 530

**F:** +34 902 108 532

**France****HNE Médical SA**

451 Chemin de Champivost  
BP20, 69579 Limonest Cedex

**T:** +33 (0)4 78 66 62 66

**F:** +33 (0)4 78 66 62 67

**United States of America****Huntleigh Healthcare L.L.C.**

40 Christopher Way  
Eatontown  
New Jersey 07724-3327

**T:** +1 (732) 578-9898 or

+1 (888) 223-1218

**F:** +1 (732) 578-9889

**Nederland****Huntleigh Healthcare BV**

Antennestraat 45  
1322 AH Almere

**T:** +31 (0)36 533 55 88

**F:** +31 (0)36 547 50 75

**New Zealand****Huntleigh Healthcare Ltd**

Unit 6/38 Eaglehurst Road  
Ellerslie, Auckland, New Zealand

**T:** +64 9 525 2488

**F:** +64 9 525 2433

**South Africa****Huntleigh Africa (Pty) Ltd**

Willem Cruywagen Avenue  
Stand 120, Klerksoord

Pretoria, South Africa

**T:** +27 12 542 4680

**F:** +27 12 542 4982

**Sverige****Huntleigh Healthcare AB**

Box 30012  
S-200 61 Limhamn

**T:** +46 (0)40 36 03 50

**F:** +46 (0)40 49 43 75

**Switzerland****HNE Médical**

5 Route de Fribourg  
1723 MARLY

Switzerland

**T:** +41 (0) 26 436 2059

**F:** +41 (0) 26 436 2060







Huntleigh  
HEALTHCARE

**HUNTLEIGH HEALTHCARE LIMITED**

310-312 Dallow Road, Luton,  
Bedfordshire, LU1 1TD, United Kingdom

**T:** +44 (0)1582 413104 **F:** +44 (0)1582 459100

Sales Enquiries **T:** +44 (0) 1582 745700 **F:** +44 (0)1582 745745

Service Enquiries **T:** +44 (0)1582 745777 **F:** +44 (0)1582 745869

Huntleigh Rentals 24 Hour Helpline **Lo-call** 08457 342000

**W:** [www.huntleigh-healthcare.com](http://www.huntleigh-healthcare.com)



943447



93/42/EEC

Registered No: 942245 England, Registered Office As Above

© Huntleigh Healthcare Limited 2003

® and ™ are trademarks of Huntleigh Technology PLC

As our policy is one of continuous improvement, we reserve the right to modify designs without prior notice.

GENLIT004UK\_01

630900EN\_05