





V-0412-00



**Instruction manual  
for  
Corona discharge checker  
MK-720**

The title is centered and framed by two decorative horizontal borders. Each border features a central vine with several leaves, flanked by larger, lighter-colored leaf shapes that create a sense of depth and texture.

**JFE Advantech Co., Ltd.**



## Introduction

---



Thank you for purchasing Corona Discharge Checker MK-720 (hereinafter called “the checker”) . To ensure your safety and prevent the danger, please read “Safety Cautions” carefully and make sure to use the checker correctly.

- JFE Advantech cannot accept any responsibility for misuse of this product, for any damaged to the product that occurs during use, for any defects, or for any damages resulting from use of this product, except in cases where it can be proven legally responsible for these.
- JFE Advantech cannot accept any responsibility for damages or financial losses resulting from loss of data caused by failure or repair of the checker, battery drainage or any other reasons. We recommend that critically important data be backed up on multiple data storage media. In addition, under any circumstances we cannot accept any responsibility for loss or damage of data stored in the instrument.
- Specifications and functions of this product including accessories are subject to change without notice for the purposes of continual improvement.
- The contents of this users’ manual are subject to change without notice.
- If you find any errors in this manual or find its contents difficult to understand, please contact us.
- JFE Advantech cannot accept any responsibility for a damages or financial losses resulting from the use of this user’s manual or or the checker or on for any claims from third party.
- If your user’s manual was incorrectly bound or incomplete, please contact us for a replacement.







## Safety cautions

Some important points to be observed are listed to ensure and correct use of the product. It contains to avoid the danger of harming yourself or others and to avoid the risk of property damage. Read all explanations carefully and make sure to use the checker correctly.













### Explanation of icon types

	denotes "points to be careful about."
	denotes "actions that must be done."
	denotes "actions that must be avoided."





### Meaning of specific icons:

	Unspecified general cautions, warnings and danger alerts
	Other general actions that should be taken
	Do not disassemble
	Do not wet or expose to moisture
	Do not touch with wet hands
	Other general actions that should be avoided







## ● Points to remember when using the instrument

	<b>Warning:</b> Ignoring this caution constitutes improper use of the instrument and presents a risk of causing fatality or serious injury.
<b>Be careful of abnormal conditions.</b>	
	If the checker is used under abnormal conditions, e.g. when the checker is emitting smoke or a strange smell, there is a serious risk of fire or electric shock. If you detect abnormal conditions, immediately turn off the power, unplug the AC adapter from the outlet or disconnect the rechargeable battery pack and contact the vendor from which you bought the product.
	When object to be measured and peripheral devices are under hot line condition, do not put yourself and the checker closer to high-voltage area while measuring. When approaching high-voltage area, make sure to use insulated gloves or implement measures for insulation.
	When working with machines that are operating, never touch or try to touch any movable or moving part of a machine. Also, do not position yourself or any part of any part of your body in any area where there is risk of being caught by or between machines.
	Do not look into a laser light-emitting part. Do not tune a laser to eyes of human or animals.
	Do not let the children use.
	Make sure to remember location of emergency stop button and circuit breaker so that whenever and wherever you can.
	Never position yourself or any part of your body inside a machine that is operating, for any reason.
	Never perform measurements in unsecured or unstable positions, or with both hands occupied.
	Do not perform measurements during thunderstorms.
<b>Avoid water and foreign matter!</b>	
	If any foreign matter (e.g. metal pieces, water, liquid) gets inside the product, immediately turn off the power switch, remove a battery, and contact the vendor from which you purchased the checker.
<b>Do not drop the instrument.</b>	
	If the checker becomes damaged, is dropped or given a strong physical shock, so that it becomes damaged, please contact the vendor from which you purchased the instrument after turning off the power switch and taking out the battery pack. Ignoring this warning and continuing to use the checker may lead to result in fire or electric shock.
<b>Do not disassemble the instrument.</b>	
	To avoid the risk of fire or injury, do not disassemble or modify the instrument.

## ● Points to remember when using the instrument

 <b>Caution:</b> Ignoring this caution constitutes improper use of the instrument and presents a risk of causing injury or property damage.
<b>Memory protection</b>  Make sure to always back up the data to PC or other data storage media. This is necessary because data on the card may become corrupted or lost due to deterioration or other reasons. Data may also be lost if the checker is damaged or repaired.
<b>Storage place</b>  <ul style="list-style-type: none"><li>• To avoid the risk of fire or electric shock, do not leave the checker in humid or dusty places.</li><li>• Do not leave the checker in a place where it is exposed to oily smoke or steam, e.g. near a cooking stove or humidifier. Otherwise there is a risk of fire or electric shock.</li></ul>
<b>Do not place the instrument in an unstable place.</b>  Do not place the instrument on an unsteady table or on high shelves. If the instrument topples or falls it may cause injury.

## ● Points to remember regarding physical safety, e.g. clothing.

 <b>Caution:</b> Ignoring this caution constitutes improper use of the instrument and presents a risk of causing injury or property damage.
 If you have long hair, bind it at the back and roll it up, to avoid the risk of hair getting entangled in any moving parts while working with operating machines.
 Always wear appropriate safety equipment (helmet, dust-proof goggles, safety shoes, Insulated glove, etc.).
 Always wear a helmet when working in places where there are obstacles near head level.
 Wear proper safety shoes, with steel toecaps and oil-proof soles.
 Do not wear ill-fitting work clothes (especially if very loose). Also, make sure to button up or hook up the sleeves of your work clothes so that they cannot get entangled in any moving machine parts.
 Never work with the checker after taking medication with strong side effects, non-prescription drugs or alcohol.

## Cautions on use

Since this checker is a precision device, if it is improperly used or roughly handled, it may become damaged or fail to save data correctly. To ensure proper use of the checker, carefully read and observe the following cautions.

<p>● Do not continue using the checker when there is battery completely drained. Data may be lost or corrupted. Replace with a new battery immediately when the battery charge is very low.</p>
<p>● Do not leave the battery connected when the checker is left unused for a long time. Liquid may leak from the battery. Leaking liquid may damage the checker.</p>
<p>● Use the checker only under the following conditions:</p> <ul style="list-style-type: none"><li>• Temperature 0°C to +40°C</li><li>• Humidity range 10 to 85% (No condensation)</li></ul> <p>If the checker is used out of this range, it will become damaged.</p>
<p>● Avoid using the checker in the following places: Otherwise the checker may become damaged.</p> <ul style="list-style-type: none"><li>• Places where static electricity accumulates</li><li>• Places subject to very high or very low temperatures</li><li>• Places of high humidity</li><li>• Places subject to sudden temperature changes</li><li>• Places with a lot of dust</li></ul>
<p>● Do not place the checker in high temperature such as in the car during the daytime in summer.</p>
<p>● Do not place any heavy objects on the checker.</p>
<p>● Do not disassemble the instrument. (Otherwise the checker may be damaged.)</p>
<p>● Do not insert or allow foreign matter inside the connector.</p>
<p>● Do not spill liquids, including water, over the checker.</p>

## Cautions when discarding

When discarding the checker, please comply with the laws or regulations of local government in your country.





## Table of Contents

Introduction The outline and measurement principle of the instrument .....	1
Chapter 1 Preparation before use .....	2
1.1 Names and functions of parts .....	2
1.2 How to set dry battery .....	4
1.3 To turn on and to turn off .....	5
1.4 Initial setting .....	5
Chapter 2 Measurement and operation .....	9
2.1 The method of measurement .....	9
2.2 Button operation .....	10
Chapter 3 Data communications .....	13
3.1 Hardware requirement .....	13
3.2 Installation of a driver .....	13
3.3 The directions for a download sheet (Excel file) .....	24
Chapter 4 Troubleshooting .....	28
Chapter 5 Specification .....	30
5.1 Main part specification .....	30
5.2 Outline drawing .....	31
5.3 Standard configuration .....	31
5.4 Option article .....	32



## Introduction The outline and measurement principle

This instrument measures and memorizes the corona discharge accompanying insulated degradation. Insulated degradation is told according to the sound pressure state of corona discharge.

If the corona discharge accompanying insulated degradation of AC-power-supply equipment arises, an ultrasonic wave will occur over a broadband.

Since this ultrasonic wave produces strength synchronizing with a power supply phase, if frequency analysis is conducted after detecting detection sound, the double ingredient of power supply frequency will appear strongly.

With this instrument, electric discharge can be detected by detecting the strength of the double ingredient of this power supply frequency, without being subject to the influence of sound other than electric discharge.

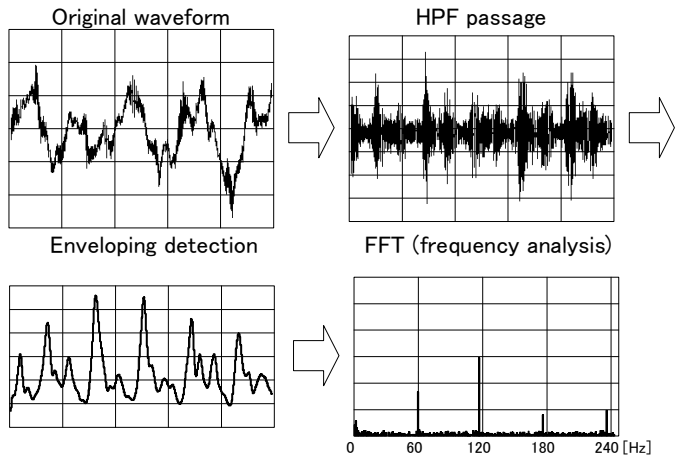

## Chapter 1 Preparation before use

### ◆ 1.1 Names and functions of parts

#### ◆◆ 1.1.1 Main unit

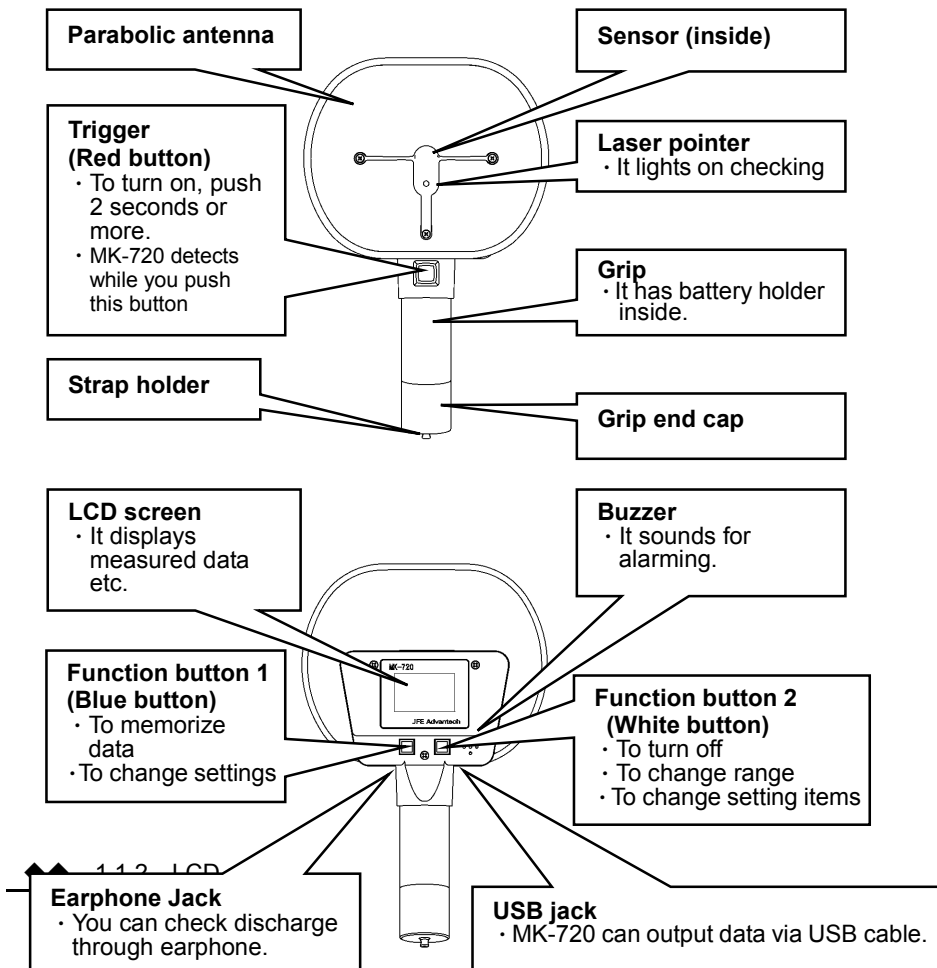

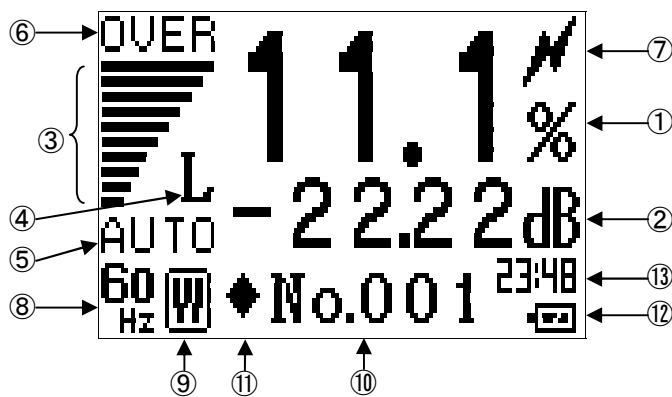

No	Displayed item
①	Discharge component rate (Intensity rate of double frequency (of power supply) to total intensity)
②	Converted sound pressure of double frequency (of power supply)
③	Level meter(for total ultrasound) 10 step display at measuring range(④)
④	Current measuring range (L, M, H)
⑤	AUTO range indicator(displayed at Auto range setting)
⑥	Range over indicator(displayed at range excess at measuring range)
⑦	Rate excess of double frequency (from preset alarm level)
⑧	Frequency of currently measuring power supply
⑨	Type of memory data ([L]: Rate of double frequency, Converted rate from ultrasound to sound pressure of double frequency, [W]: Waveform, FFT spectrum)
⑩	Index number of data which will be memorized next. (Can be chosen by pushing "L" and "W" button.)
⑪	Memory indication (It indicates that there are memorized data at index number which is currently displayed.)
⑫	Battery life indicator : Full : Low battery : Almost empty. Please change battery.
⑬	Current time (24 hour clock)



What is double frequency?

It means spectrum component of frequency which is twice of power supply frequency (100Hz or 120Hz).

◆ 1.2 How to set dry battery

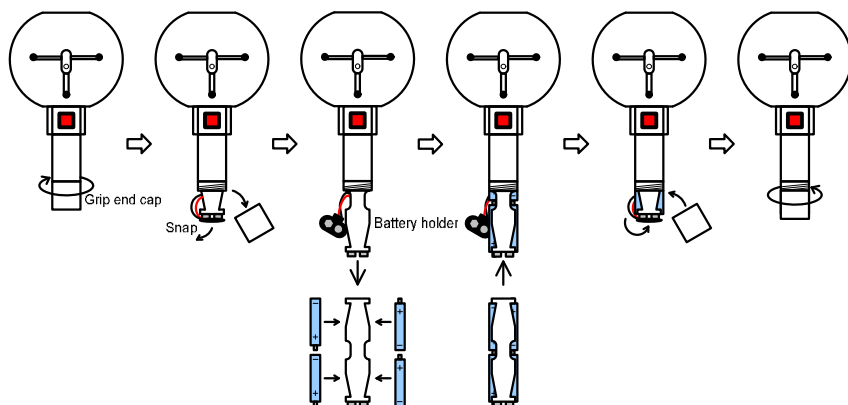

- 1 Unscrew grip end cap.
- 2 Snap off wire from battery holder.
- 3 Pull out battery holder and set 4 AA batteries.

**Attention**

Set batteries according to guidance on holder, not to make mistake about polarity (+,-).



- 4 Set battery holder into grip and connect wire. And set grip end cap.

◆ 1.3 To turn on and to turn off

【To turn on at measuring mode】

 Red	Push red button for 2 seconds or more. ( Clock setting screen is displayed in the case inner clock is reset due to low battery etc. )
--	--

【To turn on at setting mode】

 White	 Red	Keep pushing red button and white one until MK-720 turns on.
--	--	--

【To turn off】

 White	Push white button until MK-720 turns off.
--	---





**MK-720 automatically turns off after non-operation for 5 minutes.**  
**(MK-720 does not execute automatic power off when it is connected with PC.)**

◆ 1.4 Initial setting

MK-720 requires initial setting before measurement.  
Turn on MK-720 at setting mode (to make settings).

◆◆ 1.4.1 To turn on at setting mode

- 1 Push red button  and white one  for 2 seconds or more.
- 2 If your MK-720 is already turned on, please turn off and restart with procedure written in 1.
- 3 By pushing red button  for 2 seconds and more, MK-720 transitions from (any screen of) setting mode to measuring mode.

Setting values which are finally displayed are memorized for this operation.



Setting values which are finally displayed are NOT memorized by turning off by automatic power-off or turning off with pushing white button  for 2 seconds or more.

◆◆ 1.4.2 Initial setting

There are 4 items in initial setting.

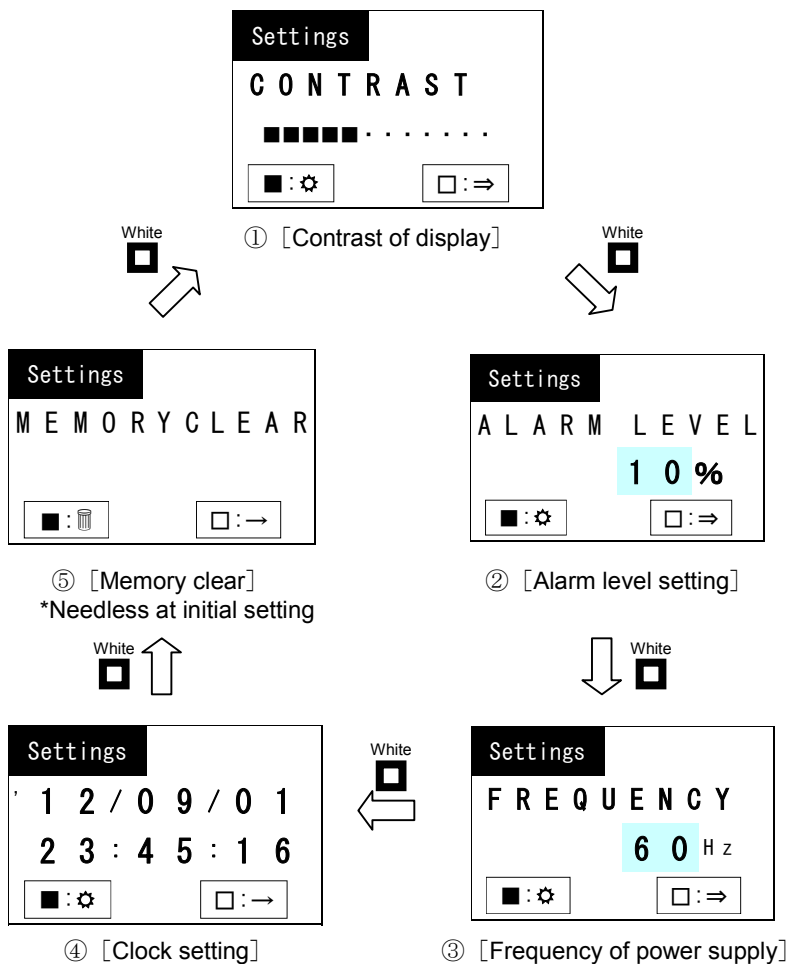

- Contrast of display
- Alarm level setting
- Frequency of power supply of object
- Clock setting

Screen of MK-720 transitions in the order showed below after turning on at setting mode.



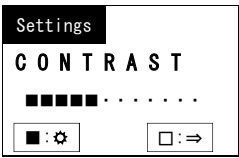

**1** Setting of contrast

MK-720 displays [Settings CONTRAST] first after turning on at setting mode.

	<p>Blue</p> 	<p>It is for adjusting of contrast. You can make dark by pushing blue button (12 steps). After push at darkest setting, screen goes to brightest one.</p>
	<p>White</p> 	<p>MK-720 is set at current contrast setting by one push of white button. MK-720 transitions to [Alarm level setting].</p>

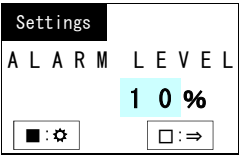

**2** Alarm level setting

MK-720 displays [Settings ALARM LEVEL] after push of white button  after turning on at setting mode.

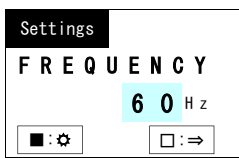

	<p>Blue</p> 	<p>It is for setting alarm level. You can set from 0% to 50% After push at 50%, setting value returns to 0%. To cancel alarm, set it 0%.</p>
	<p>White</p> 	<p>MK-720 is set at current alarm level setting by one push of white button. MK-720 transitions to [Frequency of power supply].</p>

**3** Setting of power supply frequency







MK-720 displays [Settings FREQUENCY] after two push of white button  after turning on at setting mode.







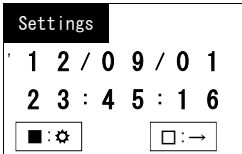

	<p>Blue</p> 	<p>Set power supply frequency used in operation area. (50Hz or 60Hz)</p>
	<p>White</p> 	<p>MK-720 is set at current frequency by one push of white button. MK-720 transitions to "Clock setting".</p>

#### 4 Clock setting

MK-720 displays “Settings yy/mm/dd, hh, mm, ss” after **three** push of white button  after turning on at setting mode 

<To set clock of MK-720>

1. Turn on at setting mode.
2. Push white button  three times to transition to clock setting mode
3. Push blue button  for 2 seconds or more. Cursor on screen appears after releasing of button.
4. Move cursor by pushing white button .
5. Change values by pushing blue button .
6. Move cursor on space for seconds, and push blue button .
7. Transition to “MEMORY CLEAR” screen, by pushing white button .
- (Do not push white button  not to make MK-720 turns off,)
8. To transition from “MEMORY CLEAR” screen to “CONTRAST” screen, push white button.

	 Blue button	<ol style="list-style-type: none"> <li>1. To transition to clock setting screen, push blue button  for 2 seconds or more.</li> <li>2. To set clock, push blue button when cursor is on space for seconds. (After this operation, seconds goes to “00” .)</li> </ol>
		<ol style="list-style-type: none"> <li>1. To transition from time setting screen to “MEMORY CLEAR” screen, push white button .</li> <li>*MK-720 transitions from “MEMORY CLEAR” screen by pushing white button.  .</li> <li>2. To move cursor, push white button .</li> </ol> <p>(ss→hh→mm→yy→mm→dd→ss)</p>

## Chapter 2 Operation and checking

### ◆ 2.1. How to check

Power distribution box etc.

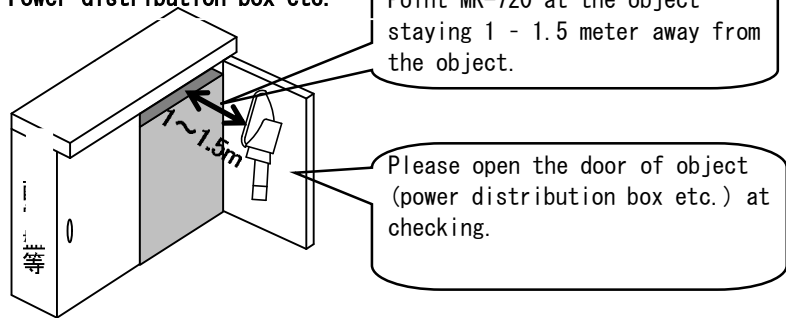

There is danger in checking objects of high voltage at hot line condition.  
Keep safe distance from object.

#### ◆◆ 2.1.1. How to use ultrasonic sensor

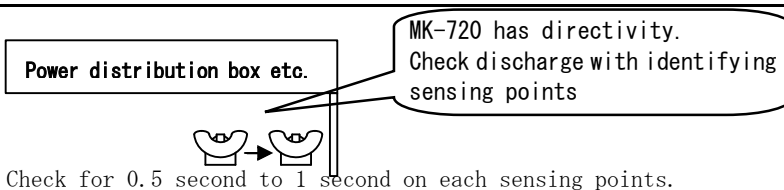





◆◆ 2.1.2. Recommendation of use of earphone

We recommend using earphone while checking to reduce burden of checking. If you hear low sound from earphone, see screen.



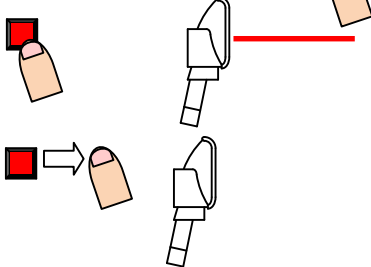

 MK-720 automatically turns off after 5 minutes of no operation.

◆ 2.2 Checking operation by button

◆◆ 2.2.1. Sensing

- 1 Push red button. 
  - 2 MK-720 continues checking while you keep pushing red button.
  - 3 After you release red button, MK-720 indicates data you checked last.
  - 4 MK-720 start sensing again by second push of red button. 
  - 5 MK-720 points sensing area by laser. 
- When you release red button, laser pointer stops.

◆◆ 2.2.2. Range switching





- 1 You can switch range by pushing white button  at sensing (=while you are pushing red button  ). Range switching cannot  be done while MK-720 is not sensing.
- 2 Range switching order is as follows.  
AUTO→L(low)→M(middle)→H(high)→AUTO
- 3 At AUTO range setting, MK-720 switches range from L. And if sensed value is high, automatically switch range to M, and to L.  
At the case that you start checking again after you stopped, MK-720 (at AUTO range setting) start sensing at L range.
- 4 Range setting (AUTO, L, M, H) is kept after turning off.  
MK-720 starts sensing at range memorized at previous sensing.
- 5  In the case MK-720 displays “OVER” at fixed range setting such as L, M, and H, it means scale-over. Switch to higher range.

◆◆ 2.2.3. How to memorize data

- 1 Data is memorized by pushing blue button  while data is hold at idle state. Data memorizing cannot be done at sensing state. (While you push red button.  )
- 2 Maximum  memory volume and memory contents

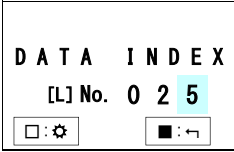
	contents	Maximum volume
[L]	Double frequency rate, Converted value from of double frequency ultrasound to sound pressure, Date of measuring	500 records
[W]	Waveforms of enveloped ultrasound, FFT spectrum, Top 10 values, Date of measuring	10 sets of record



- 3 You can choose L and W by pushing white button  at idle state.
- 4 MK-720 stores data under data number which is displayed on screen. Data of L and W is stored under each different number. Data number is automatically issued, and data number increases one by one.
- 5 You can freely change data number.  
(Only at non-measuring condition.)





	 Blue button	<ol style="list-style-type: none"> <li>1. MK-720 switches into data number changing mode by pushing blue button  for 2 seconds or more. And it will return to normal mode by one more pushing of blue button. </li> <li>2. You can change number which is on cursor.</li> <li>3. MK-720 does not return to normal mode when number you set is out of range. [L] range: 1 - 500 [W] range: 1 -10</li> </ol>
	 White button	<ol style="list-style-type: none"> <li>1. You can choose digit position by pushing white button.</li> </ol>

- 6 MK-720 indicates “Overwrite?” in the case that MK-720 has data under data number which is currently indicated. By pushing blue button, data is overwritten. By pushing white button, overwriting is suspended

◆◆ 2.2.4. Clearing of memorized data

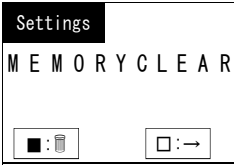
Clearing of memorized data can be done at setting mode.

- 1 Turn on at setting mode. (Push red button  and white button  )
- 2 Push white button  four times to transition to “Settings MEMORY CLEAR” .

	 Blue button	To clear memory, push blue button.  This is applied to all data. (= All data is cleared by this operation.)
	 White button	To transition to “Setting CONTRAST” without clearing memory, push white button. 

## Chapter 3. Data communication

MK-720 is able to send memorized measuring record to computer via USB cable.

### ◆ 3.1. System requirements

To utilize data on PC, MK-720 requires environments showed below.

Item	Recommended environments
OS	Windows XP, Vista, 7
Excel	Excel2002, 2003, 2007, 2010
Computer	Computer which enables normal operation of Windows and Excel
Disk drive	CD-ROM drive (for installation only)

### ◆ 3.2. Installation of driver software

#### ◆◆ 3.2.1. For Windows Vista® and Windows 7®

1 Set installation disk on disk drive of the computer.

2 Connect USB port of computer and that of MK-720 with USB cable.

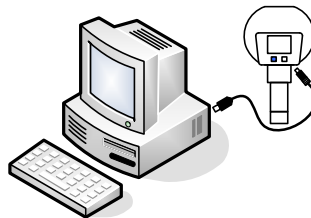

3 Turn on MK-720 by pushing red button  for 2 seconds or more.

4 Computer may display a display window as showed below, on Windows Vista® Choose “Ask me again later” or “Don’t show this message again for this device” .

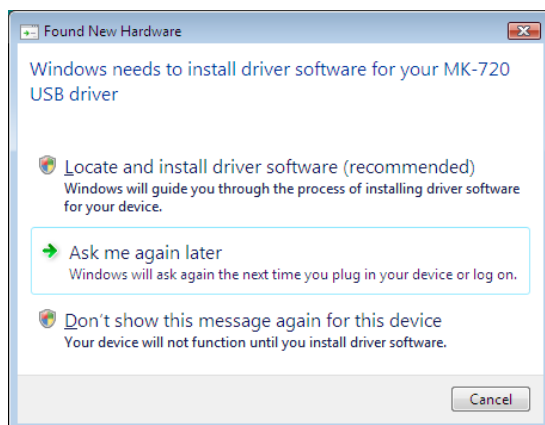

5 Open **[control panel]** .

6 Click **[Hardware and Sound]** .



- 7 Click **【Devices and Printers】** on Windows 7, and do **【Device Manager】** on Windows Vista

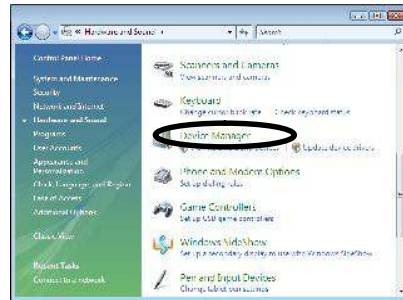
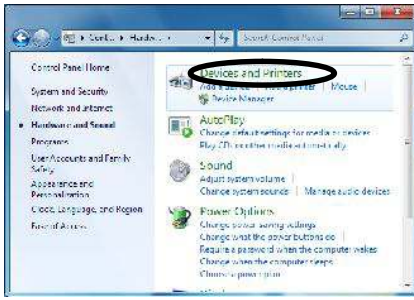

- 8 Right click **【MK-720 USB driver】** in **【Other devices】** and do **【Update Drive Software】**.  
In the case you cannot find **【Update Drive Software】**, please retry after a few seconds later.



- 9 Click **【Browse my computer for driver software】**

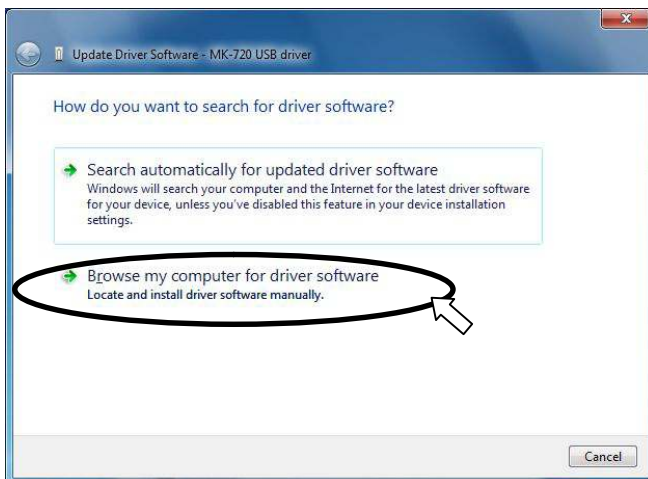

- 10 Click “Browse” button and choose the folder which has driver software. (Most common choice is “MK-720\_USB\_driver” .)  
Click “Next” button after selection of folder.

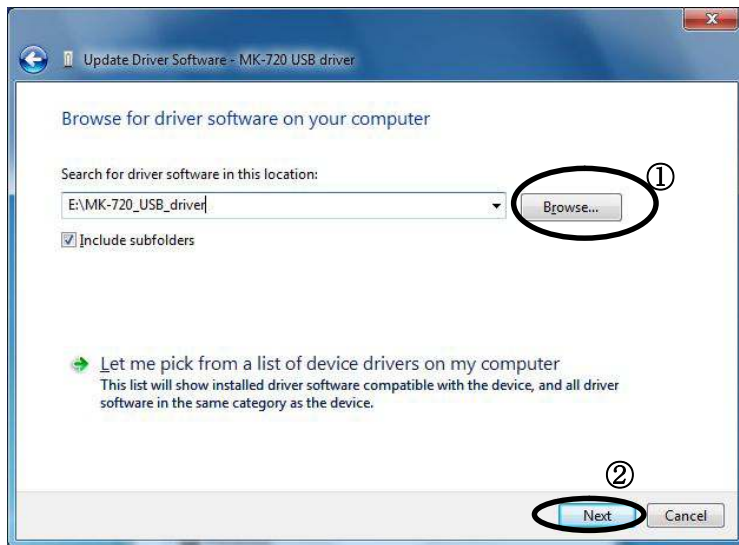

- 11 Click [Install this driver software anyway] at the case that security warning window appears.

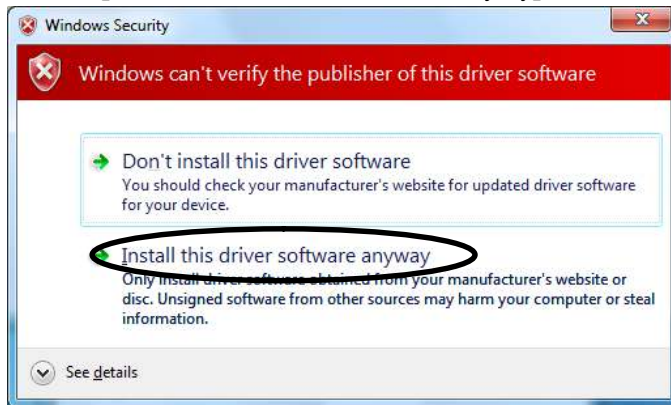

- 12 Installation of driver software shall start

- 13 Click “Close” button.



- 14 Open “Control panel” to install USB serial port.

- 15 Right-click “USB Serial Port” in “Other devices” at “Device Manager” , and click “Update driver software” .  
(In the case that you cannot find “Update Driver Software” , please retry after a few seconds later.)

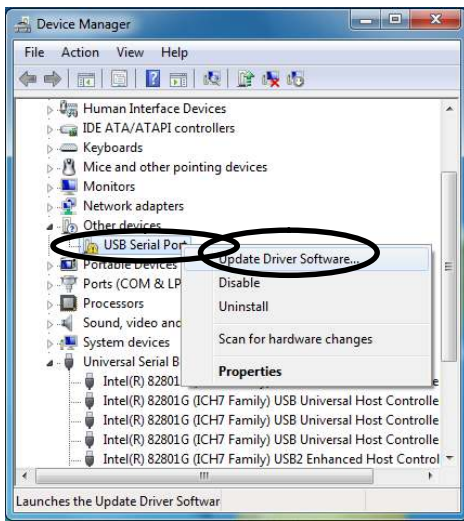

- 16 Install in the same way as procedure showed from 9 to 12.
- 17 Click “Close” button after completion of driver software installation.

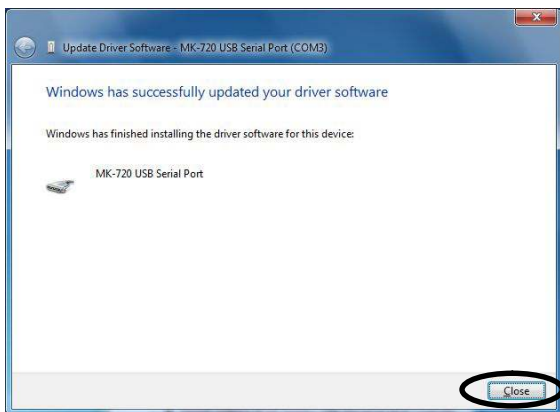



- 17 Confirm “MK-720 USB Serial Port (COM X) (☆ X is numeric) is added in “Ports(COM & LPT) at “Device Manager” . Take note of the number “X” . COM number will be required to utilize “Download sheet” . This COM number differs by computer by computer.

◆◆ 3.2.1. For Windows XP

1 Set installation disk on disk drive of the computer.

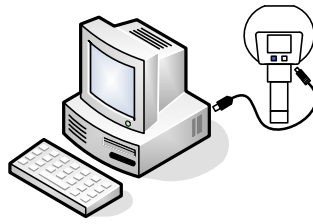
2 Connect USB port of computer and that of MK-720 with USB cable.



3 Turn on MK-720 by pushing red button  for 2 seconds or more.

4 Computer will display “Found New Hardware Wizard” .  
Choose “Install from a list of specific location [Advanced]” and click “Next” .

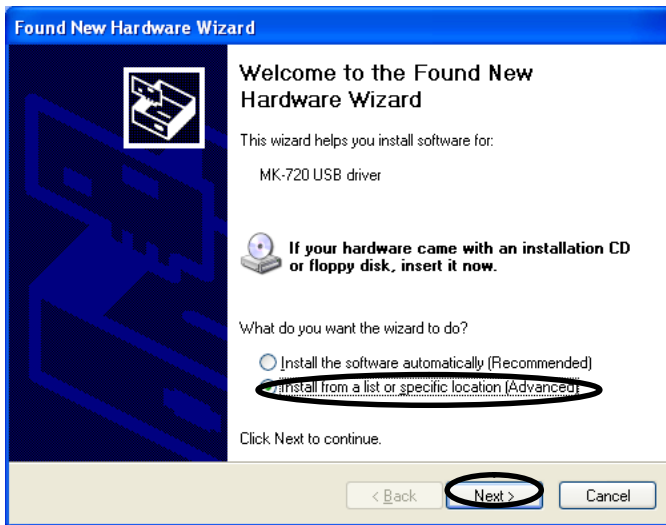

5 Choose “Search for the best driver in these locations.” and check on boxes ( “Search removable media [floppy, CD-ROM...]

and “Include the location in the search:” ).  
Click “Browse” button and choose the folder which has driver software. (Most common choice is “MK-720\_USB\_driver” .)  
Click “Next” button after selection of folder.

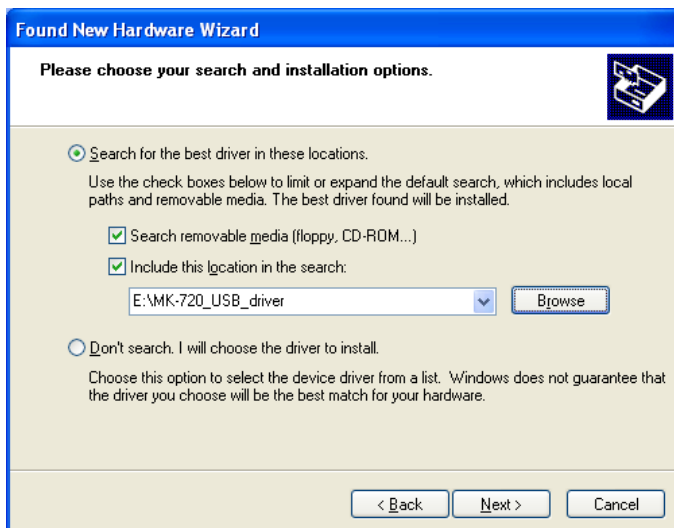

- 6 Click “Continue anyway” . Please neglect warning dialogue window for this case.

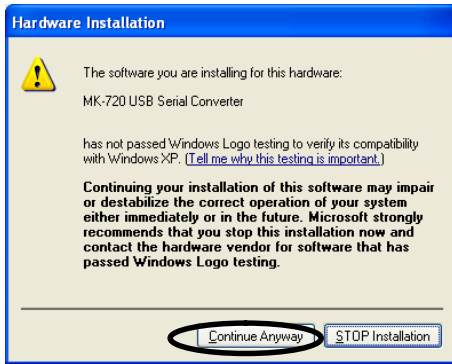

- 7 Installation of driver software shall start.

- 8 Click “Finish” button after completion of driver software installation.

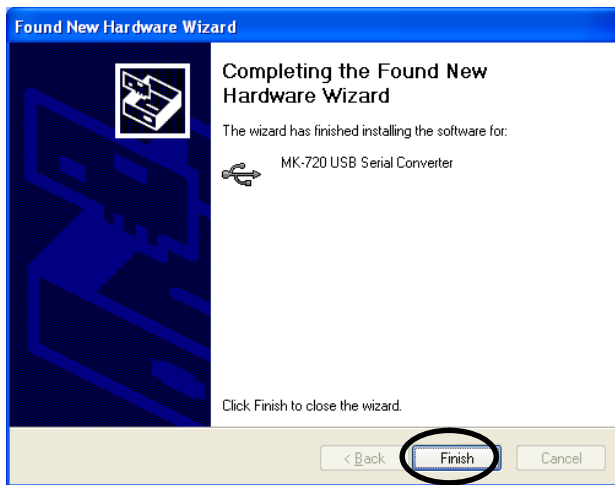



- 9 “Found New Hardware Wizard” shall be displayed after clicking of “Finish” in step 8. Choose “Install from a list of specific location [Advanced]” and click “Next” .

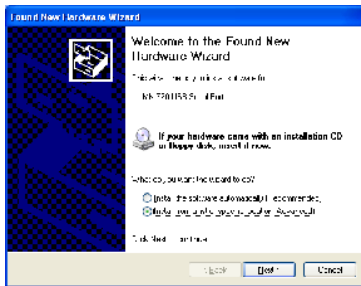

- 10 Install in the same way as procedure showed from 5 to 7.

- 11 Click “Close” button after completion of driver software installation.

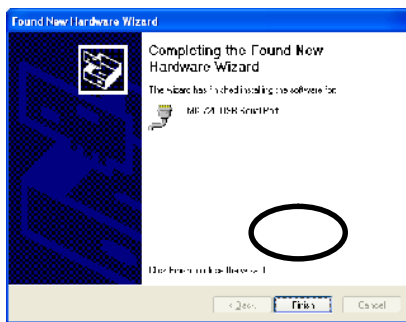

- 12 Open “Control Panel” .

- 13 Click “Performance and Maintenance” .

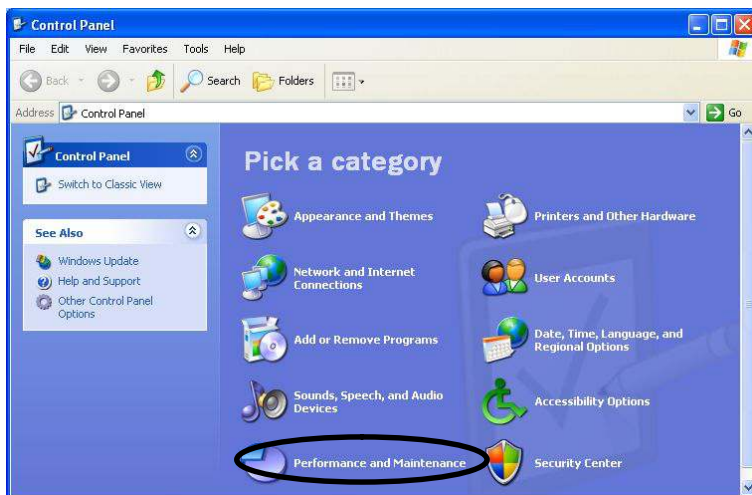

14 Click "System" .

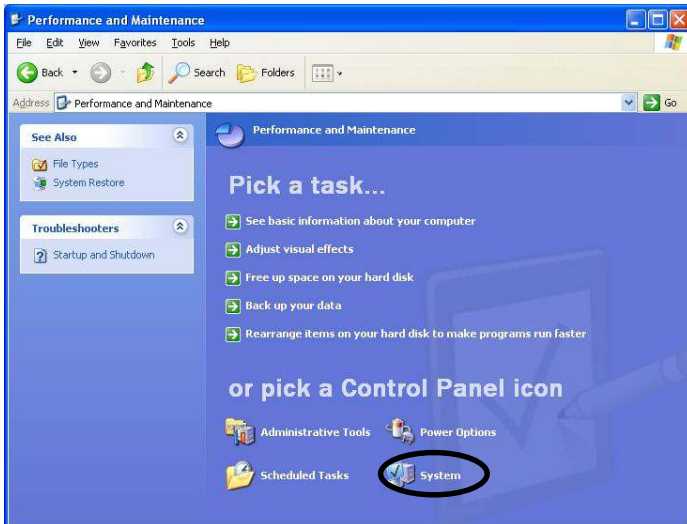

15 "System properties" dialogue box will open. Click "Hardware" tab and do "Device manager" .

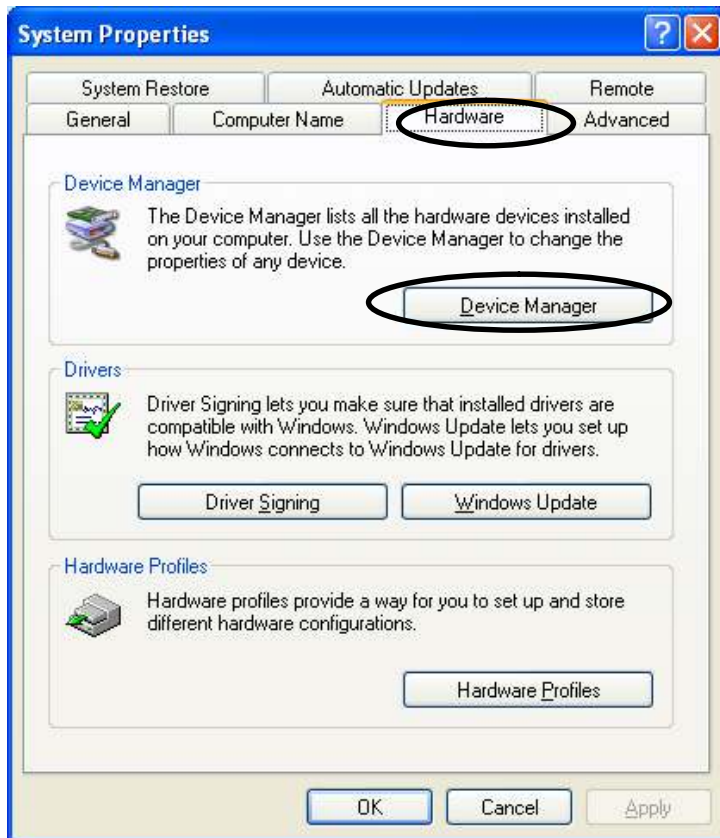

- 16 Confirm “MK-720 USB Serial Port (COM X) (☆ X is numeric) is added in “Ports (COM & LPT) at “Device Manager” . Take note of the number “X” . COM number will be required to utilize “Download sheet” . This COM number differs by computer by computer.

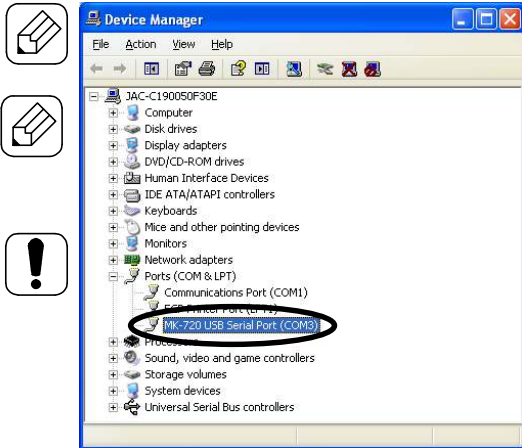

### 3.2. How to use download sheet (Excel files)

- 1 Open “MK-720 data download sheet” .

MK-720 requires Microsoft Excel version Excel 2002, 2003, 2007, and 2010. at use of Excel software.

“MK-720 data download sheet.xls” file is stored in CD included in standard configuration of MK-720. Please utilize after downloading to your computer.

Macro function should be enabled to use “MK-720 data download sheet” . See page 28 to check details.

- 2 Set COM number (which is noted at installation of driver software) on USB serial port of download sheet.

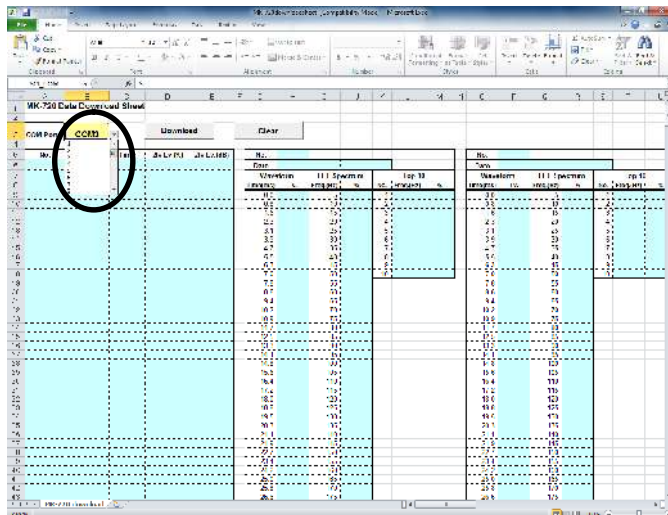

- 3 Connect USB port of computer and that of MK-720 with USB cable.

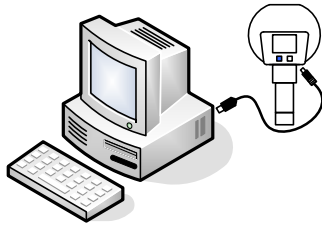

- 4 Turn on MK-720 by pushing red button  for 2 seconds or more. MK-720 will automatically display “USB DOWNLOAD” .



- 5 Click “Download” button on “Download sheet” . Downloading shall start.

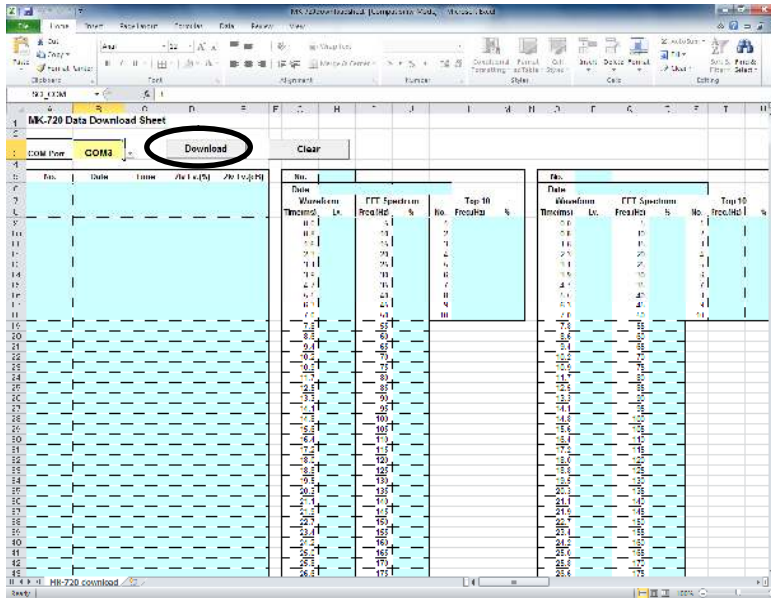

- 6 To clear currently displayed data, click “Clear” button.

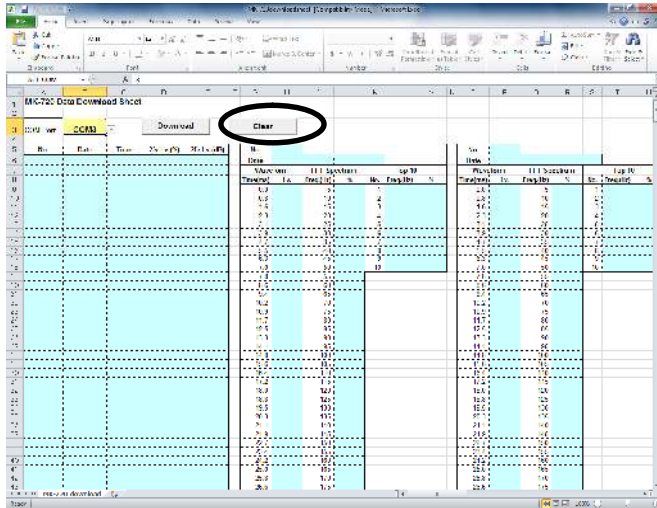

- 7 To store downloaded data, save datasheet with naming.



Data stored in MK-720 is not cleared by downloading. To clear data in MK-720, do in procedure written in page 12.)

●To enable macro function

Computer may display warning about macro function at opening downloading sheet (Excel file). Set macro or contents enable for this case.

- (1) For Excel2007 and Excel2010

Click “Enable content” button on yellow bar on the top of display.

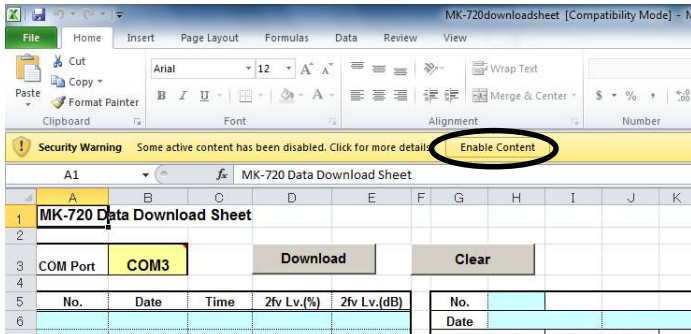

- (2) (2) For Excel2003

Click “Enable Macros” button on security warning window as showed below.

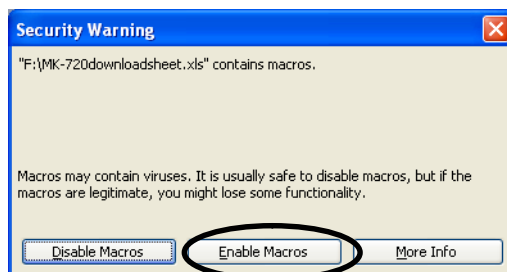

In the case “Download” button or “Clear” button is effective without being displayed security warning window, proceed filing.

If “Download” button or “Clear” button is NOT effective and security warning window is NOT displayed, security level is set at very high class. Set security level to enable macro according to guidance of Excel 2003.

## Chapter 4 Troubleshooting

Check this list first for the cases which are to be considered as malfunctions.

If any case which is not in this list occurs, or if the case it is not recovered even after countermeasure shown here, contact the agent from which you purchased. In the case you had purchased from us directly, please send email to us.

<Tokyo@jfe-advantech.co.jp>

Please kindly let us know the model name, type number, and symptoms at contacting us.

Symptoms	Possible causes	Countermeasure	Refer page xx.
Mk-720 cannot be powered up.	Battery setting is incorrect.	Check if the battery is inserted correctly.	P.2
	Batteries drained.	Renew batteries.	P.2
Screen does not display.	Battery setting is incorrect.	Check if the battery is inserted correctly.	P.2
	Batteries drained.	Renew batteries.	P.2
	Contrast setting is not appropriate.	Set again at contrast adjustment window in setting mode.	P.3
Double frequency component rate and/or sound pressure is seemed too small.	MK-720 is not pointed toward correct direction.	MK-720 has directivity. Please point MK-720 toward correct direction.	P.4
	Sound does not leak from distributing box etc.	MK-720 is an instrument which catches sound. So it cannot catch discharge from facilities which do not allow sound leaking.	P.4
	Measuring range setting is not correct.	MK-720 may be not able to detect discharge at the case of measuring in H range for small sound. Choose appropriate range such as L or M.	P.5
Sound is not audible from an earphone	Earphone is not connected properly.	Connect earphone code correctly.	—
	Earphone is out of order.	Check earphone. (ex. connect earphone with other device such as radio.)	—
	The sound is too small.	There may be a case that MK-720 catch ultrasound but sound from earphone is very small. Please check your MK-720 using reference oscillator etc.	—
Communication with computer is impossible.	USB cable is not connected properly.	Connect USB cable correctly.	—
	Driver software is not installed.	Install driver software.	P.6
	COM port number is incorrect.	To enable communication between MK-720 and computer, COM port number (indicated by computer) must be set on datasheet. Set correct COM port number on datasheet.	P.9

## Chapter 5 Specification

### ◆ 5.1. Hardware Specifications

Inputting part	Sensor type	Piezoelectric type
	Sensing center frequency	40kHz
	Detection sensitivity	-63±3dB (@30cm, As sensor)
	Directivity	±8
	Laser pointer	Semiconductor laser diode 1Mw (Class 2 JIS C 6802 and IEC 6825-1), Wavelength 650nm
Measuring part	Sampling frequency	1280Hz
	Number of sample data	256 points
	Frequency range	500Hz
	Resolution	By 5Hz
	A/D conversion	16bit
	Dynamic range	65dB and over
	Window	Rectangular
Outputting part	Display	STN liquid crystal display (128×64 dots)
	Contents	Discharge component rate Converted value in acoustic pressure
	Output	Buzzer (for alarming), Earphone jack (Signal output terminal, 3.5mm OD mini jack) USB port for data output (USB mini B port)
Data storage	Discharge component rate, Converted value in acoustic pressure (Maximum 500 records), 10 sets of waveform of enveloped ultrasound, FFT spectrums, and top 10 data	
Other specifications	Power source	AA Alkaline dry battery X 4 • Automatic power off after no operation for 5 minutes and low battery (under 4.2V)
	Power consumption	1.2W
	Battery life	Continuous 8 hours (at 0°C to 50°C)
	Operating temperature / humidity	0 - 40°C, 10 - 85% (No condensation)
	Storage temperature / humidity	-10 - 50°C, 10 - 85% (No condensation)
	Dimensions	W 174 × H 268 × D 98 (mm)
	Mass	Approx. 400g (batteries are NOT included)

### ◆ 5.2. Outside view

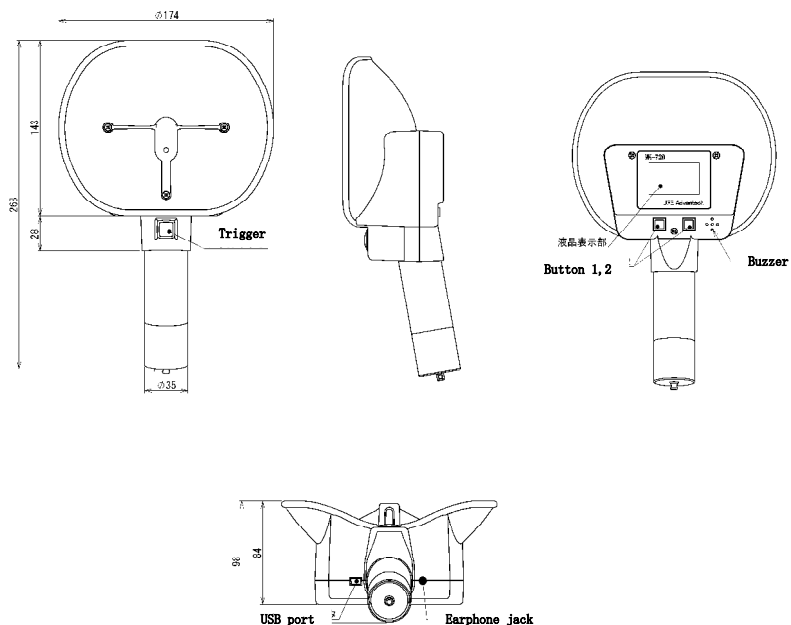

◆ 5.3. Standard configuration

Corona discharge checker	MK-720	1 unit
AA Alkaline dry battery	LR6AG	4 ea.
USB cable	KU-SLAMB510BK	1 ea.
Communication software (in 1 CD)	MK-9804	1 ea.
Earphone	ME-L82	1 ea.
Strap		1 ea.
Instruction manual		1 ea.

◆ 5.4. Option

Reference oscillator (MP-161)	
Carrying bag (MK-9702)	
Carrying case (MK-9703)	