

MICROFUSION **SCR POWER CONTROLLERS** **USER'S MANUAL**



CONTROL CONCEPTS, INC. 2 YEAR LIMITED WARRANTY

CONTROL CONCEPTS, INC. warrants that the products delivered will be as described in the sales order or contract.

CONTROL CONCEPTS, INC. warrants to the original user that CONTROL CONCEPTS, INC. products will be free from defects in materials and workmanship for a period of two (2) years after the date CONTROL CONCEPTS, INC. ships such products.

If any CONTROL CONCEPTS, INC. product is found to be defective in material or workmanship during the applicable warranty period, CONTROL CONCEPTS, INC.'s entire liability, and purchasers sole and exclusive remedy, shall be the repair or replacement of the defective product at CONTROL CONCEPTS, INC.'s election. CONTROL CONCEPTS, INC. shall not be liable for any costs or expenses, whether direct or indirect, associated with the installation, removal or re-installation of any defective product. All shipping and freight costs are the responsibility of the customer. CONTROL CONCEPTS, INC.'s limited warranty shall not be effective or actionable unless there is compliance with all installation and operating instructions furnished by CONTROL CONCEPTS, INC., or if the products have been modified or altered without the written consent of CONTROL CONCEPTS, INC., or if such products have been subject to accident, misuse, mishandling, tampering, negligence or improper maintenance. Any warranty claim must be submitted to CONTROL CONCEPTS, INC. in writing within the stated warranty period.

CONTROL CONCEPTS, INC.'s limited warranty is made in lieu of, and CONTROL CONCEPTS, INC. disclaims all other warranties, whether expressed or implied, including but not limited to any IMPLIED WARRANTY OF MERCHANTABILITY, ANY IMPLIED WARRANTY OF FITNESS FOR A PARTICULAR PURPOSE, any implied warranty arising out of a course of dealing or of performance, custom or usage of trade.

CONTROL CONCEPTS, INC. SHALL NOT, UNDER ANY CIRCUMSTANCES BE LIABLE FOR ANY DIRECT, INDIRECT, INCIDENTAL, SPECIAL OR CONSEQUENTIAL DAMAGES (INCLUDING, BUT NOT LIMITED TO, LOSS OF PROFITS, REVENUE OR BUSINESS) OR DAMAGE OR INJURY TO PERSONS OR PROPERTY IN ANY WAY RELATED TO THE MANUFACTURE OR THE USE OF ITS PRODUCTS. The exclusion applies regardless of whether such damages are sought based on breach of warranty, breach of contract, negligence, strict in tort, or any other legal theory, even if CONTROL CONCEPTS, INC. has notice of the possibility of such damages.

By purchasing CONTROL CONCEPTS, INC.'s products, the purchaser agrees to the terms and conditions of this limited warranty.

WARNING: The Control Concepts, Inc. power controllers use power thyristors to switch voltage to the connected load. Line voltage must be assumed at the output terminals at all times, even when the control signal has been removed and the load voltage appears to be off. It has been mandated by the National Electrical Code and the Occupational Safety and Health Act of 1970 that a physical disconnect be opened ahead of all remotely actuated controls before performing any maintenance work on the controller or its connected load.

PROPRIETARY DATA

© Copyright 2009, Control Concepts, Inc. Chanhassen, MN 55317

The information and design disclosed herein are the property of Control Concepts, Inc. and may not be used, reproduced or disclosed in any form except as granted in writing by:

CONTROL CONCEPTS, INC
18760 LAKE DRIVE EAST
CHANHASSEN, MN 55317
PHONE: (952) 474-6200
TOLL FREE: (800) 765-2799
FAX: (952) 474-6070
www.cciipower.com



Listed 3L32 - Industrial Control Equipment
100kA Short Circuit Current Rating
File Number E136219



EN60947-4-3
IP 20
See CE Declaration of Conformity



Part 15 Subpart B
Class A Device



See RoHS Certificate of Compliance

DECLARATION OF CONFORMITY

MicroFUSION Series SCR Power Controller

Control Concepts, Inc.
18760 Lake Drive East
Chanhassen, MN 55317 USA



Declares that the following product:

Designation: MicroFUSION Series Power Controller
Model Numbers: Model uF, followed by 1 or 3, followed by HX or SX, followed by T or R or 4DY or 6DY or 64Y or 6ID, followed by A through Z, followed by any number or letter, followed by numbers -01 through -80, followed by "-" and numbers and/or letters
Classification: Solid State Power Controller, Class I, Pollution Degree II
Rated Voltage: 24 - 600 Vac
Rated Frequency: 45 - 65 Hz

Meets the essential requirements of the following European Union Directive(s) using the relevant section(s) of the normalized standards and related documents shown:

EN 60947-4-3: 2007 Low-voltage switchgear and controlgear

EMC Directive 2004/108/EC

-EN 61000-6-2: 2005

-EN61000-4-2: 1995 + Amendments A1:1998 + A2: 2001

-EN61000-4-3: 2006

-EN61000-4-4: 2004 + Corrigendum 2004

-EN61000-4-5: 2006

-EN61000-4-6: 2007

-EN61000-4-8: 1993 + Amendment A1: 2001

-EN61000-4-11 Second Edition: 2004

-EN 61000-6-4: 2007

ESD Immunity

Radiated Immunity

EFT / Burst Immunity

Surge Immunity

Conducted Immunity

Magnetic Field Immunity

Voltage Dips & Interruptions

Conducted & Radiated Emissions

Note 1: All power terminals must be populated as to keep the controller touch safe to comply with EN 60947-4-3.

Note 2: Controller must be mounted in a shielded enclosure to comply with EMC Directive 2004/108/EC.

Note 3: Controller must have appropriate line and control power filter to comply with EN61000-6-2.

Third party conformance testing conducted by TÜV America.

TÜV SÜD America Inc.
Suite 104
1774 Old Highway 8 NW
New Brighton, MN 55112-1891

Name of Authorized Representative: Cory Watkins
Title of Authorized Representative: President

Place of Issue: Chanhassen, Minnesota, USA
Date of Issue: April 2014

Signature of Authorized Representative

Date

4/22/2014

External EMI filters must be used in conjunction with the FUSION series power controllers to maintain CE immunity* approval. The following filters were used during the immunity testing.

Universal input power:
Schaffner filter
P/N: FN 2030-3-06

Line input power:
Schaffner filter
P/N: FN 3270H-35-33

The Schaffner filter for universal input power, or it's equivalent, may be used as listed above. The line input power filter however, will need to be sized accordingly for your load. Please contact Schaffner EMC Inc. for help finding the appropriate filter.

Schaffner EMC Inc.
52 Mayfield Avenue | Edison, New Jersey 08837 / USA
T 1-800-367-5566 | T 732-225-9533 | F 732-225-4789
usasales@schaffner.com | <http://www.schaffner.com/us>

*No filtering is required for emissions.

Wire filters as shown below:

1 Phase Controller

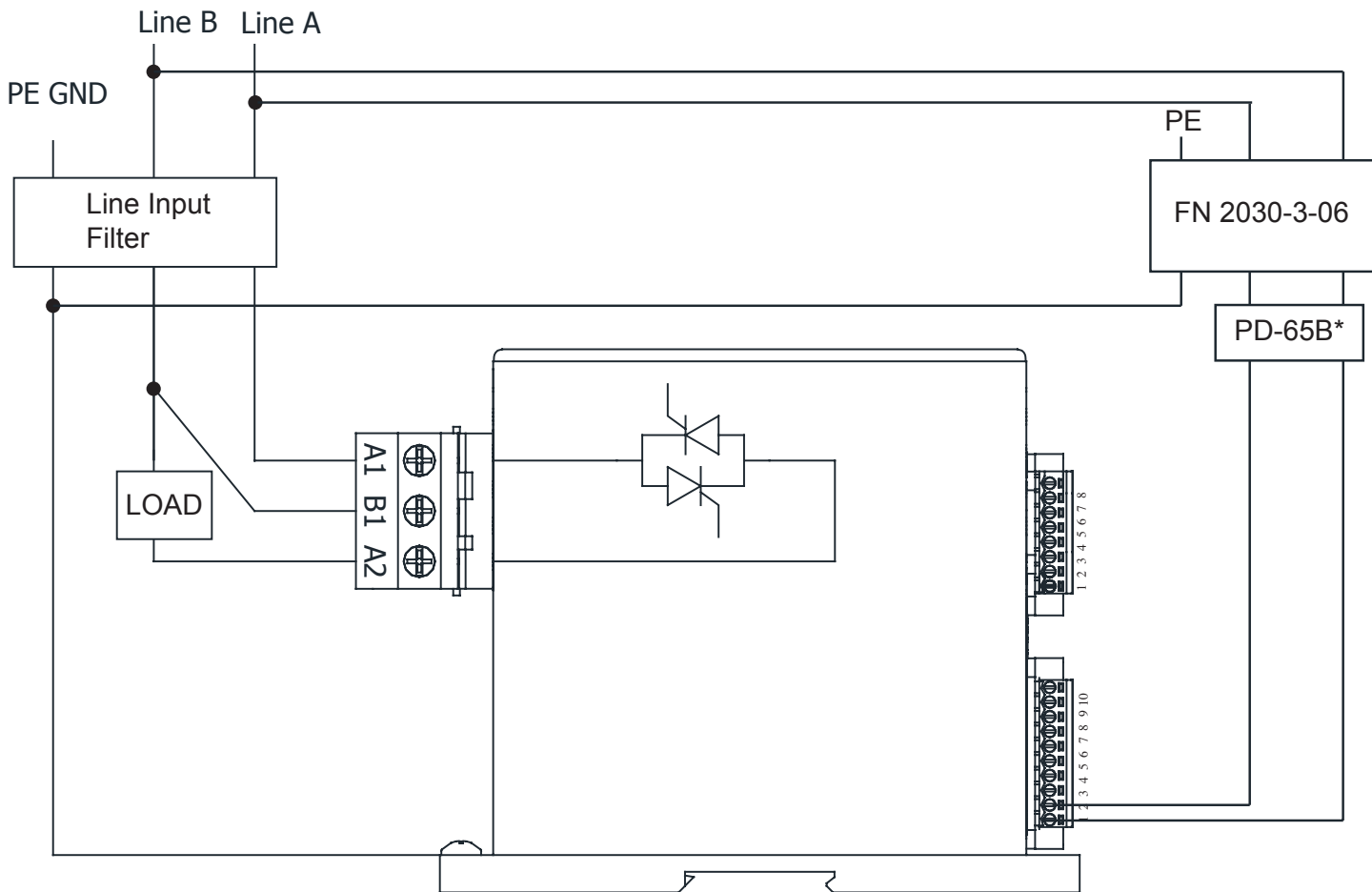

* Tests were conducted with Mean Well USA, Inc. 24 Vdc power supply model PD-65B

3 Phase Controller

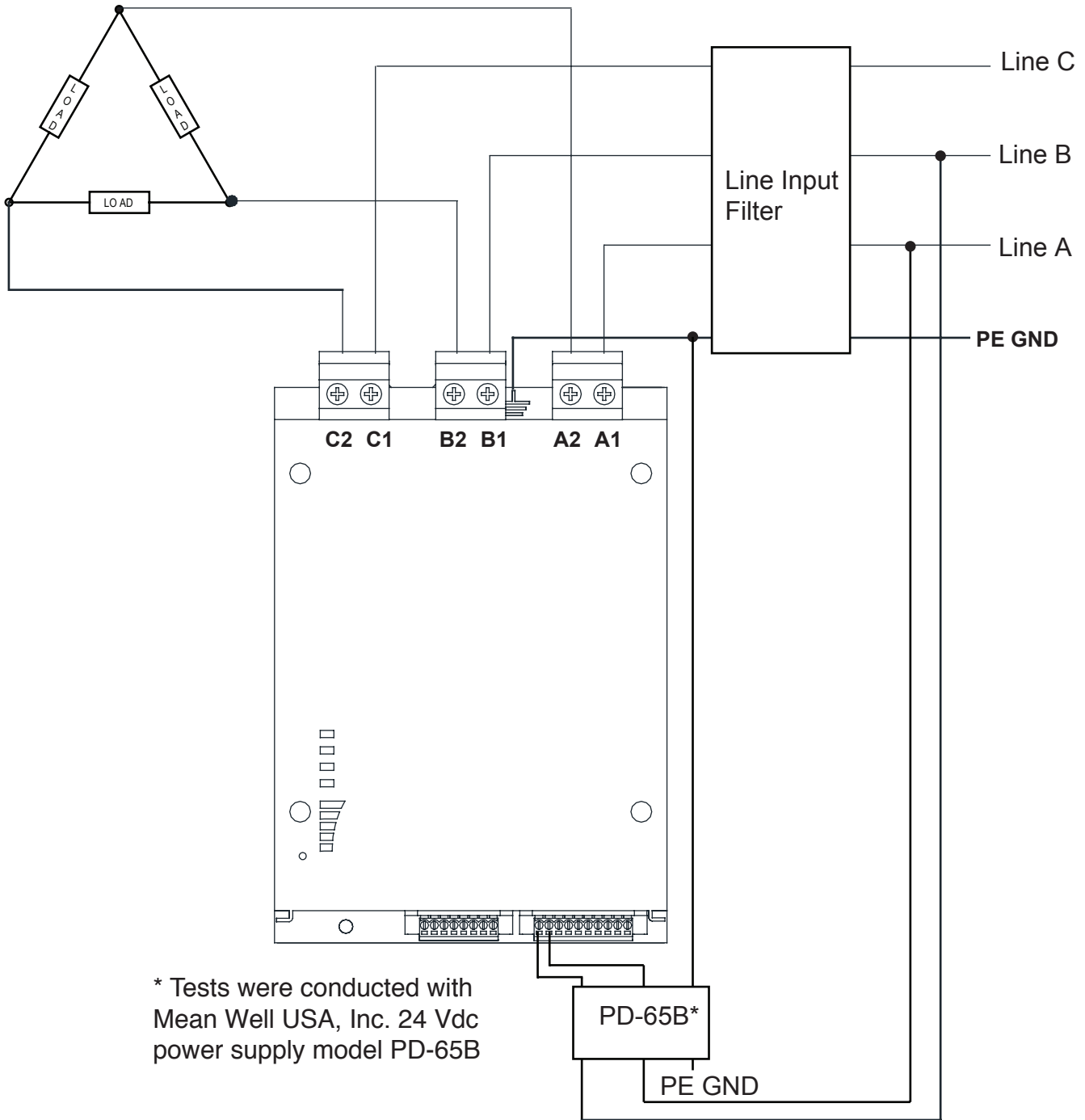

* Tests were conducted with Mean Well USA, Inc. 24 Vdc power supply model PD-65B

Other wire diagrams are available, for models not listed here, by contacting Control Concepts, Inc.

ATTENTION

This product has been designed for class A equipment. Use of this product in domestic environments may cause radio interference, in which case the user may be required to employ additional mitigation methods.

NOTICE

This product has been designed for environment A. Use of this product in environment B may cause unwanted electromagnetic disturbances, in which case the user may be required to take adequate mitigation measures.

PB-FREE/REDUCTION OF HAZARDOUS SUBSTANCE (RoHS)
CERTIFICATE OF COMPLIANCE



This document certifies that Control Concepts, Inc's products listed in the table are fully RoHS compliant as of Nov 13, 2009 in accordance with EU RoHS Directive 2002/95/EC. The products listed in the table have been identified as RoHS compliant do not exceed the maximum limit for the six substances: Lead, Mercury, Cadmium, Hexavalent chromium, Polybrominated biphenyls and Polybrominated diphenyl ether.

PRODUCT FAMILY	PART NUMBERS	DATE ADDED
FUSION	FUSION-□□-□-□□□□-□-□□□□-□□□□	11/13/2009
FUSION CF	CF-□□-□-□□□□-□-□□□□-□□□□	12/20/2010
MicroFUSION Single Phase	uF1-□□□□□□-□□-□□□□□□	4/1/2014
MicroFUSION Three Phase	uF3-□□□□□□□□-□□-□□□□□□	4/1/2014

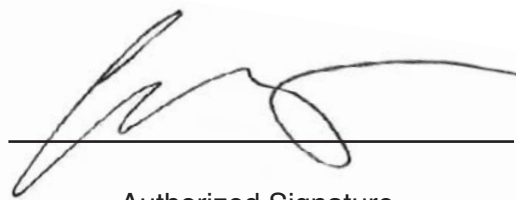

Authorized Signature
 Cory Watkins, President

4/22/2014

Date Last Updated

CONTROL CONCEPTS, INC.
 18760 LAKE DRIVE EAST
 CHANHASSEN, MN 55317
 (952) 474-6200
 1-800-765-2799
 FAX (952) 474-6070
 www.ccipower.com

TABLE OF CONTENTS

DECLARATION OF CONFORMITY	ii
CERTIFICATE OF COMPLIANCE	v
1. OVERVIEW	1
1.1 Certifications / Markings	1
1.2 Points of Interest.....	2
1.3 Feature Comparison.....	3
1.4 Model Options & Description	4
1.5 Load Types	4
2. INSTALLATION	5
2.1 Mounting Considerations.....	5
2.1.1 Single Phase (8 - 32 Amps)	6
2.1.2 Single Phase (50 - 80 Amps)	7
2.1.3 Three Phase (16 - 80 Amps).....	8
Three Phase Two Leg (16 - 80 Amps)	8
2.1.4 Six Position Multizone - External Mount	9
2.1.5 Ten Position Multizone - External Mount.....	10
2.1.6 Three Position - Liquid Cooled.....	11
2.1.7 Six Position - Liquid Cooled.....	12
2.1.8 Ten Position - Liquid Cooled	13
2.1.9 Three Phase External Mount Heatsink (16 - 50 Amps).....	14
2.1.10 Three Phase Liquid Cooled Heatsink (16 - 80 Amps).....	15
2.2 External and Panel Mounting.....	16
2.3 Mounting Instructions.....	17
2.4 Liquid Cooled Connections.....	19
3. WIRING	20
3.1 Torque Specifications.....	20
3.2 AC Line / Load Connections	21
3.2.1 Single Phase.....	21
3.2.2 Three Phase, 2 Leg	22
3.2.3 Three Phase, Delta or Wye.....	23
3.2.4 Three Phase, Four Wire Wye	24
3.2.5 Three Phase, Inside Delta	25
3.3 Connectors	26
3.3.1 P1-10 Pin Command Connector	26
3.3.2 P2-8 Pin Command Connector.....	26
4. INDICATOR LEDs	27
5. USB INTERFACE	28
5.1 USB Interface	28
6. OPTION BOARD	28
6.1 Internal Factory Industrial Communications	28
6.2 External Factory Industrial Communications	28

7. PERFORMANCE.....	29
7.1 Feedback [SP 1]	29
7.1.1 Feedback Type Calculations.....	29
7.1.2 External Feedback.....	30
7.1.3 Feedback Source [SP19].....	30
7.2 Firing Mode [SP 2].....	31
7.2.1 Phase Angle.....	31
7.2.2 Zero Cross	32
7.2.3 Zero Cross Transformer Mode (ZCT)	33
7.3 Control Mode [SP 3]	33
7.4 Full Scale Settings.....	34
7.4.1 Full Scale Voltage [SP 8]	34
7.4.2 Full Scale Current [SP 9]	34
7.4.3 Full Scale Power [SP 10]	34
7.5 Setpoints.....	34
7.5.1 Setpoint Source [Setpoint 1 Source] & [Setpoint 2 Source].....	35
7.5.2 Control Setpoint Select [SP104]	35
7.5.3 Digital Setpoints [SP100] & [SP101].....	35
7.5.4 Digital Run/Stop [SP129]	35
7.5.5 Setpoint Resolution [SP115]	36
7.5.6 Analog Setpoints	36
7.6 Run / Stop.....	36
7.7 Limits and Trip Parameters.....	37
7.7.1 Voltage Limit [SP 11]	37
7.7.2 Current Limit [SP 12].....	37
7.7.3 Over Current Trip [SP 14]	37
7.7.4 Power Limit [SP 15]	38
7.8 Tap Change Indication	38
7.8.1 Setting Using Control Panel Software.....	38
8. I/O.....	39
8.1 Alarm Relay [SP16, SP85].....	39
8.2 Isolated I/O (Optional).....	39
8.3 General Purpose Input.....	40
8.4 General Purpose Input Function [SP133]	40
8.5 Pulse Width Modulation Input.....	40
8.6 Retransmits.....	40
9. CCI LINK™	41
9.1 Network LED Indicators	41
9.2 Auto Terminating Resistor Circuit.....	41
9.3 SYNC-GUARD™	42
9.4 External Fieldbus Module	43
10. ACCESSORIES.....	44
10.1 CCI Link™ Cables	44
10.2 Fieldbus Module	44
10.3 Remote Display	44
10.4 Din Rail Power Supplies	44
10.5 USB Cable	44

APPENDIX A: SPECIFICATIONS	45
APPENDIX B: DIGITAL FIELDBUS.....	47
APPENDIX C: REMOTE DISPLAY	48
Screen Lists	48
Parameter Lock.....	48
APPENDIX D: FUSING OPTIONS	49
Touchsafe Kits: Single Phase	49
Touchsafe Kits: Three Phase	49
APPENDIX E: 1Ø PART NUMBERS	50
APPENDIX E: 3Ø PART NUMBERS	51

1. OVERVIEW

MicroFUSION is an ultra-compact high-performance microprocessor-based power controller, available in single, three phase, or three phase two leg models to control AC loads.

Resistive or transformer-connected loads can be controlled in either Phase Angle, Zero Cross, or Zero Cross Transformer (ZCT) Mode. Output is controlled linearly with respect to command signal and can be set to the average or RMS value of the voltage and current, as well as true instantaneous power or external feedback.

MicroFUSION Series power controllers are available in current ratings from 8, 16, 32, 50, 80 amps AC. Auto-ranging voltage circuitry enables main supply voltage from 24-600 VAC, (45-65 Hz) eliminating the need for hardware jumpers or stocking multiple controllers for international voltages. A separate 24 Vdc power source supplies the control electronics and maintains critical communications to your control system when the mains are absent.

Status LEDs and an LED bar graph make operation and troubleshooting simple. A plug-n-play USB interface and free MicroFUSION Control Panel software for the PC further simplifies installing and configuring the controller to your application. For example, controller settings can be duplicated simply by loading a configuration file saved from a previous unit.

Setpoints can be controlled through the standard analog or optional digital fieldbus interface. The factory-configured analog setpoint signal ranges are 0 - 5 Vdc and 4 - 20 mA, both of which are field scalable from 0 - 10 Vdc or 0 - 20 mA.

External fieldbus interface options include DeviceNet™, EtherNet/IP, EtherCAT, PROFINET, Modbus RTU (RS-485), or Modbus TCP. These can be used to communicate with a PLC or factory control system. PROFINET, Modbus TCP, and EtherNet/IP are available as internal fieldbus options. Furthermore, a single external network module can control up to ten zones, reducing system installation costs.

The robust design of MicroFUSION allows for continuous full-frame current operation - without derating - at up to 50° C / 6000 ft altitude. Cooling is accomplished through either natural convection, forced air, optional external panel mount, or optional liquid-cooled chill plate.

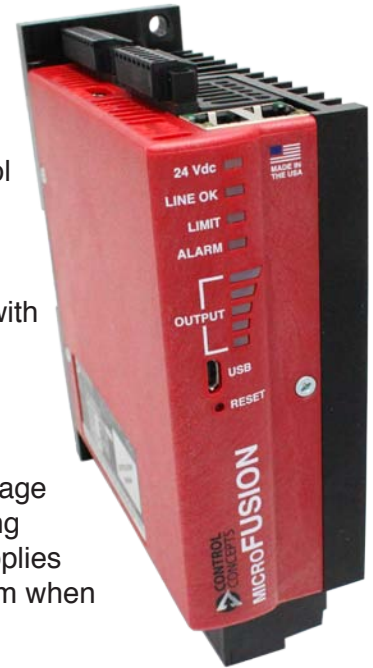

1.1 Certifications / Markings



In addition to certification markings, the controllers will also be marked with:

- | | |
|---|------------------------|
| Model Number | Serial Number |
| Voltage Range (24 - 600 Vac) | Current Size |
| Control Concepts contact information | Frequency (45 - 65 Hz) |
| Torque information on Line / Load connections | |

1.2 Points of Interest

A. CCI LINK™

A proprietary deterministic digital bus that enables multiple Control Concepts devices to communicate with each other.

B. DIGITAL COMMUNICATIONS OPTION

PROFINET, Modbus TCP, and EtherNet/IP are available as internal fieldbus options.

C. RETRANSMITS & RELAY CONNECTIONS

(P2) Retransmits and Relay

D. OPTIONAL REMOTE DISPLAY

Shows parameter name with information such as setpoints, limit settings, monitor features, alarms, and more. The display can be easily mounted outside an electrical panel for efficiency.

E. COMMAND CONNECTIONS

(P1) Analog inputs, general purpose input, + 24 Vdc supply, $\overline{\text{run}}/\text{stop}$

F. INDICATOR LEDs

Assist with Diagnostics

G. CONTROLLER RESET

MicroFUSION processor can be reset externally

H. USB PORT

Streamlines controller setup with the use of the MicroFUSION control panel.

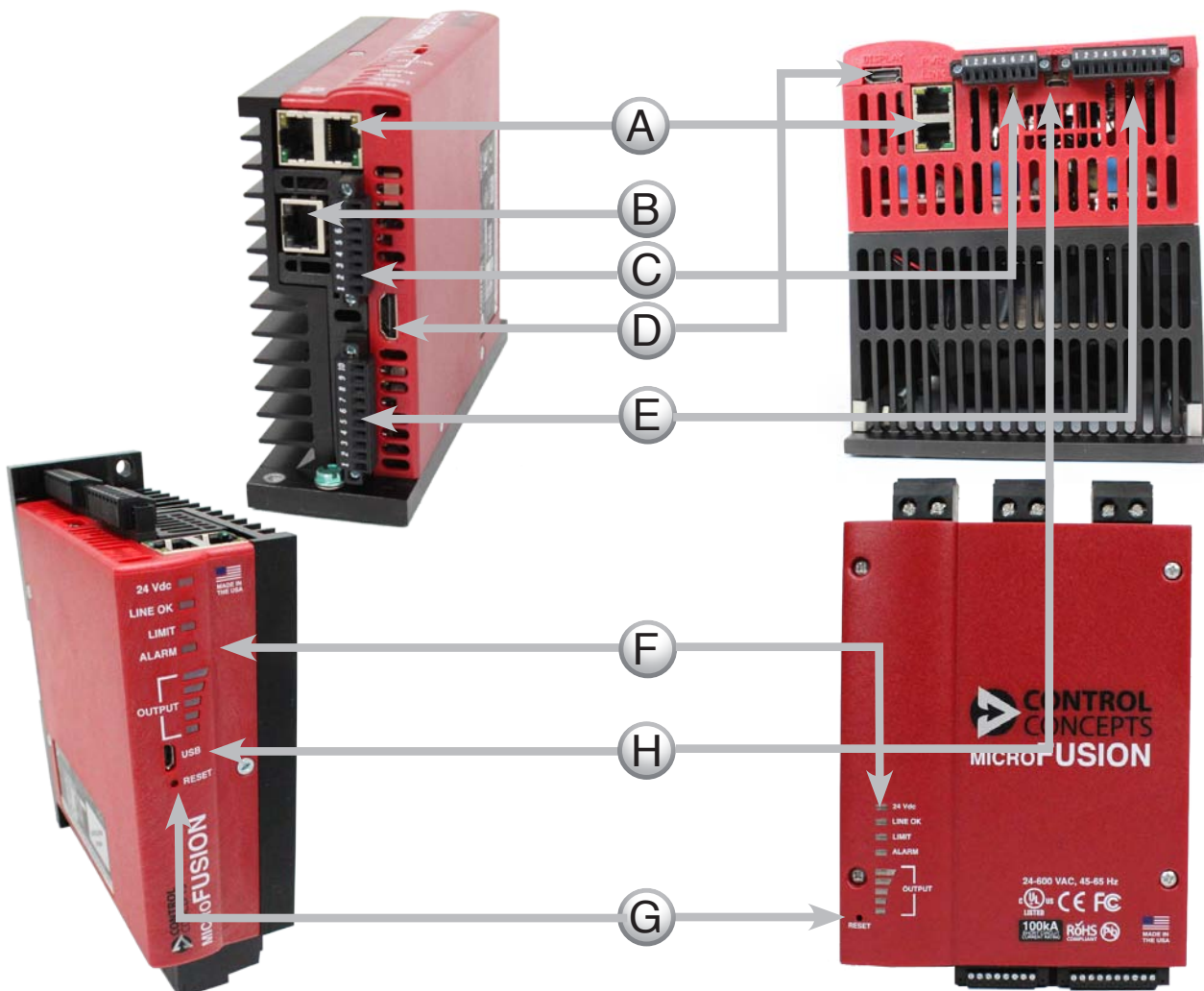

1.3 Feature Comparison

MicroFUSION is available with one of two circuit boards. SX is a lower-cost alternative, whereas HX is a fully populated board that can be field-upgraded to include retransmits and other features.

- = Included
- = Field Upgradable Option
- = Option Available at Manufacturing Time
- = Not available

FEATURE LIST	SX	HX
24-600 VAC Auto-Ranging Input	●	●
Phase Angle and Zero Cross Firing Modes	●	●
LED Bar Graph	●	●
Touchsafe Design	●	●
UL-Listed, CE, 100kA SCCR, and RoHS certifications	●	●
Micro USB Connection (USB Plug-N-Play)	●	●
Free Control Panel Software	●	●
DIN Rail Mountable	●	●
Panel Mount	●	●
RUN/STOP	●	●
Overcurrent Trip	●	●
Analog Input (0-10V, 0/4-20 mA or potentiometer)	●	●
CCI Link™ Connectivity	●	●
Fixed Current Limit - 105% of Frame	●	-
Adjustable Current Limit	○	●
Alarm Relay	○	●
Current Control	○	●
Load Voltage Control	-	●
Voltage Limit	-	●
Monitor Current	○	○
Isolated I/O	○	○
Analog Channel 2 Input	○	○
General Purpose Input	○	○
Pulse Width Modulation Input	○	○
Accessory Option: Remote Display	○	○
SYNC-GUARD™ Connectivity	○	○
External Fieldbus Options: DeviceNet, Modbus TCP, Modbus RTU, EtherNet/IP, PROFINET, EtherCat	○	○
Internal Fieldbus Options: PROFINET, Modbus TCP, and EtherNet/IP	□	□
External Panel Mount Heatsink	□	□
Water-Cooled Heatsink	□	□
Zero Cross Transformer Firing Mode	-	○
Retransmit (RTX): 2x High Resolution Analog Retransmits 0-10 VDC or 0/4-20 mA	-	○
Power Limit	-	○
True Power Control	-	○
Monitor True RMS Power	-	○
High Resolution Control Loop	-	○

1.4 Model Options & Description

Single Phase AC

The single phase AC power controller is a phase angle or zero cross fired controller. It linearly controls, with respect to the setpoint, the AC voltage, current or true power applied to an electrical load. Control is achieved by means of a pair of inverse parallel SCR's.

Three Phase - Two Leg

The three phase two leg AC power controller is a zero cross fired controller. It linearly controls, with respect to the setpoint, the AC voltage, current, or true power applied to an electrical load. Control is achieved by two pairs of inverse parallel SCR's.

Three Phase - Three Leg

The three phase three leg AC power controller is a phase angle or zero cross fired controller. It linearly controls, with respect to the setpoint, the AC voltage, current or true power applied to an electrical load. Control is achieved by three pairs of inverse parallel SCR's.

1.5 Load Types

Loads / Applications

1. Constant Resistive Loads (Nickel Chromium)
2. Variable Resistive Loads
 - a. Silicon Carbide
 - b. Molybdenum Disilicide
 - c. Graphite
 - d. Tungsten Lamps
3. Transformer Coupled Loads
4. Inductive (not intended for motor applications)
5. Gas Discharge
 - a. Ultra Violet
6. Electron Beam
7. Crystal Growing and Processing

Transformers

Scott-T & Wye transformers: Excessive voltage transients can occur when operating Scott-T transformers with an open or unloaded secondary. It is recommended that Scott-T transformer be limited to a maximum of 480 Volts.



NOTE: It is recommended that a Delta to 4-Wye transformer be used to power a 4-wire Wye load. Delta to 3-wire Wye transformers are acceptable, but Wye to Wye transformers are not suited for use between the controller and load due to possible transient conditions.

2. INSTALLATION

2.1 Mounting Considerations

Dimensions:
Inches

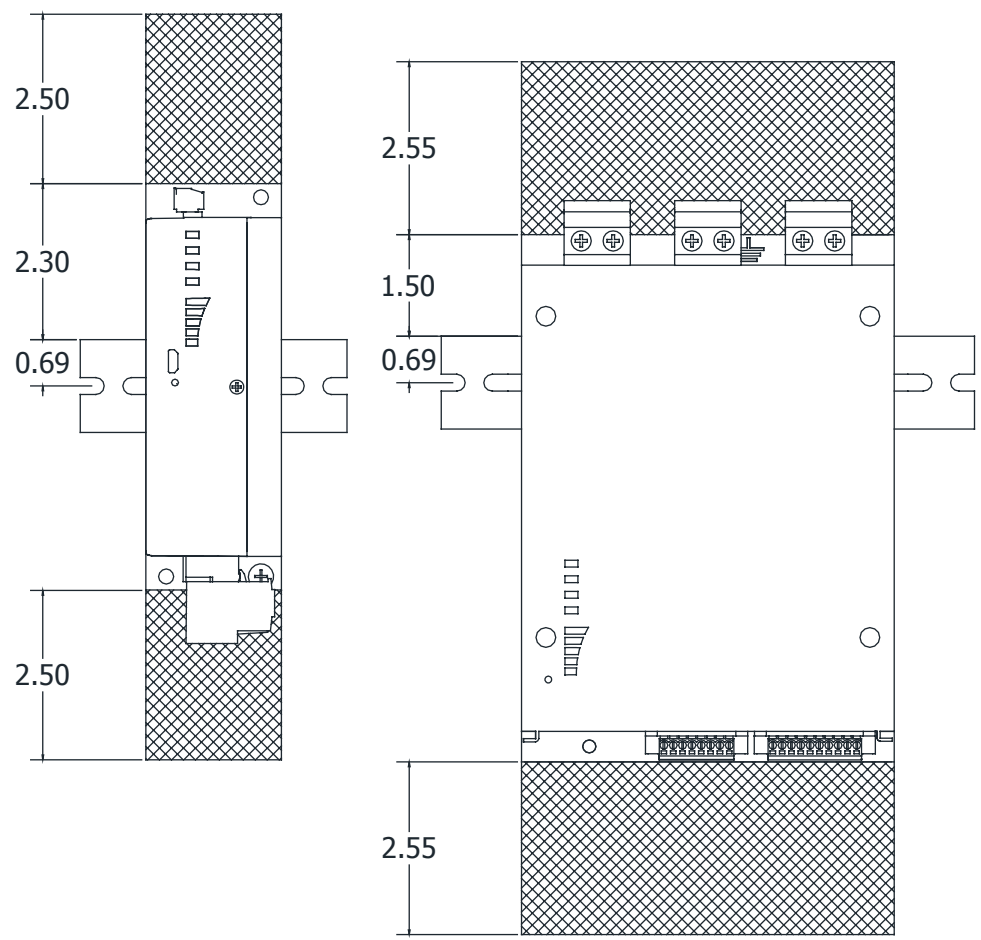
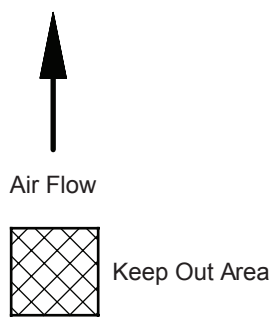

Mount controllers vertically.

The keep out area on the top and bottom is for air circulation. The top and bottom of the controller must have a minimum of 3.00 [76.2] free from obstructions as measured from the edge of the heatsink fins. Dimensions above are measured from the edge of the heatsink base.

Mounting hardware (Not included):

Figures above show dimensions for din rail mounting. For mounting hardware when not using din rail, use the following:

- Single Phase #10 or M5 screws with star washers
- Three Phase #8 or M4 screws with star washers

Din rail and/or screws are not provided.

2.1.1 Single Phase (8 - 32 Amps)

Dimensions:
Inches [mm]

Height
6.00 [152.4]
Width
2.00 [50.8]
Depth
5.10 [129.54]

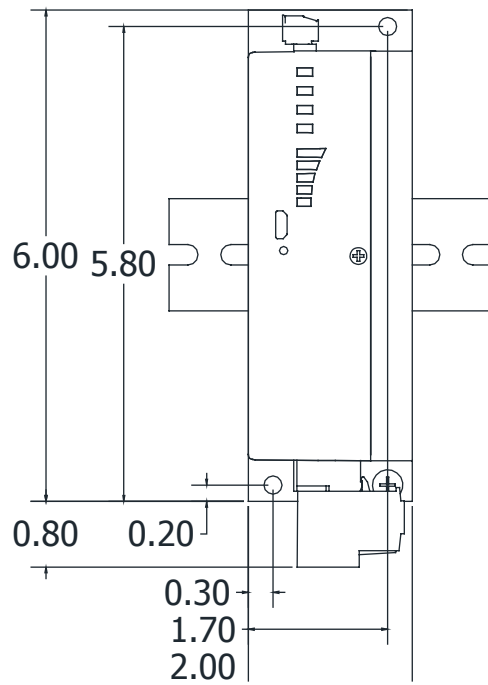

Pluggable terminal block

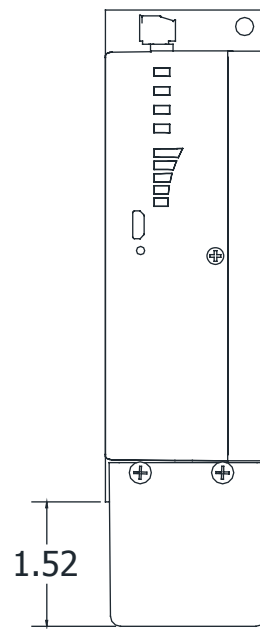

Ring Terminal

2.1.2 Single Phase (50 - 80 Amps)

**Dimensions:
Inches [mm]**

Height
6.00 [152.4]
Width
3.25 [82.55]
Depth
5.10 [129.54]

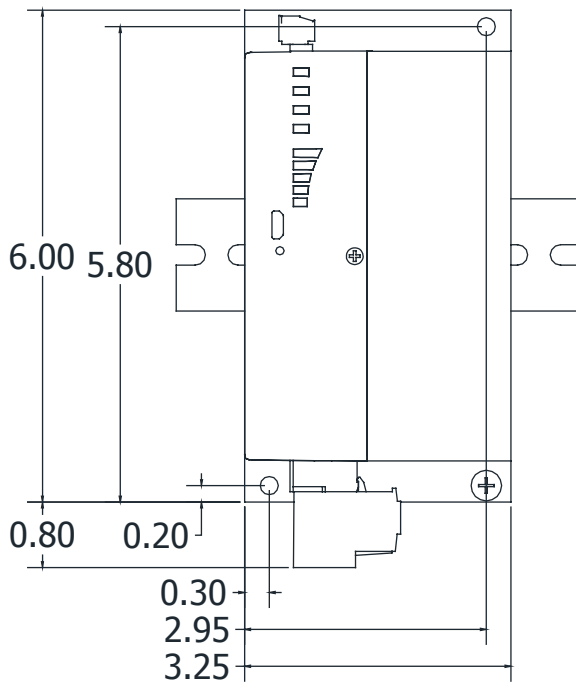

Pluggable terminal block

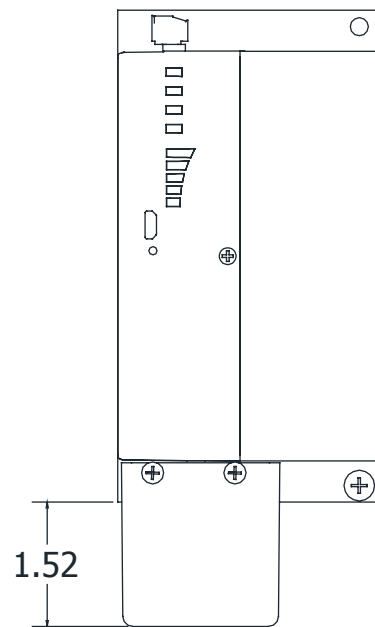

Ring Terminal

2.1.3 Three Phase (16 - 80 Amps) Three Phase Two Leg (16 - 80 Amps)

**Dimensions:
Inches [mm]**

Height
7.78 [197.61]
Width
5.50 [139.7]
Depth
6.40 [162.56]

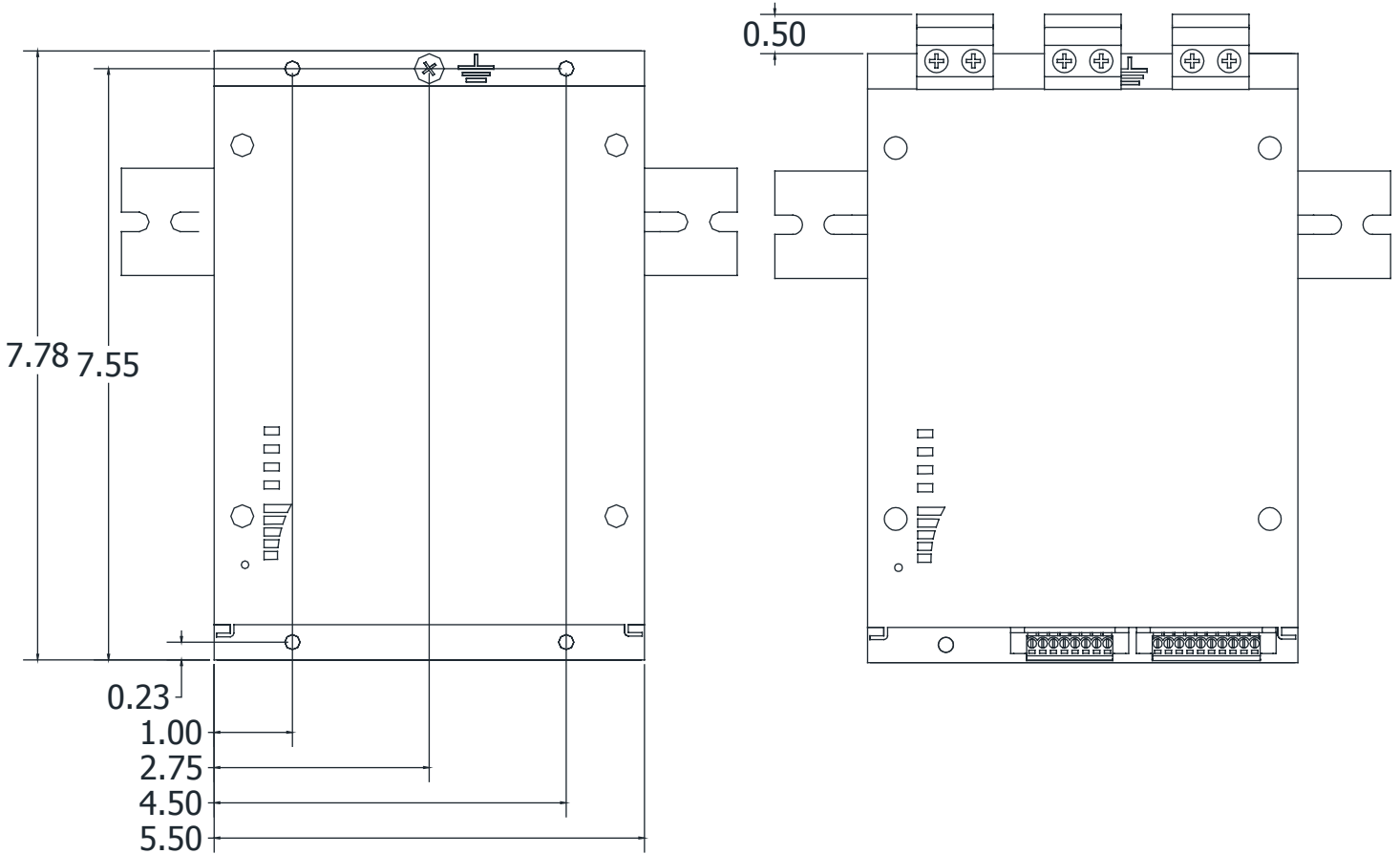

2.1.4 Six Position Multizone - External Mount

Note: Fins must be mounted vertically.

Gasket and gasketed washers included.

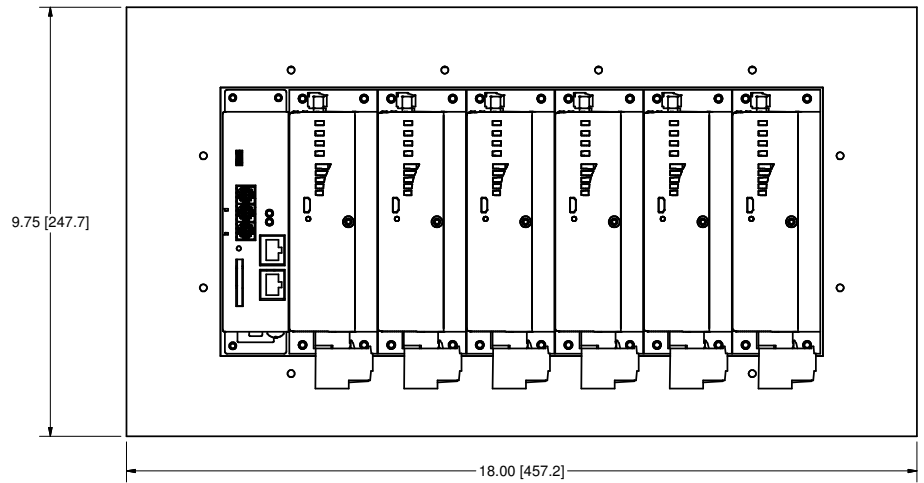
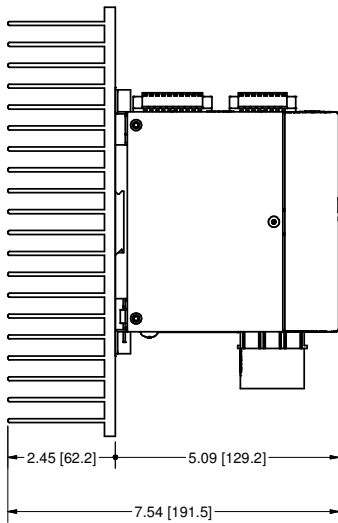
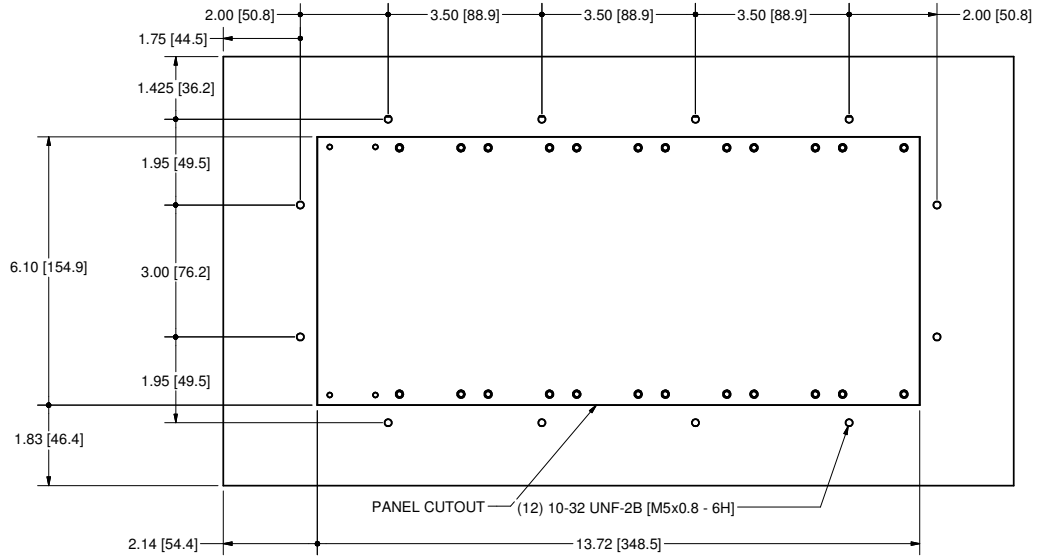

2.1.5 Ten Position Multizone - External Mount

Note: Fins must be mounted vertically.

Gasket and gasketed washers included.

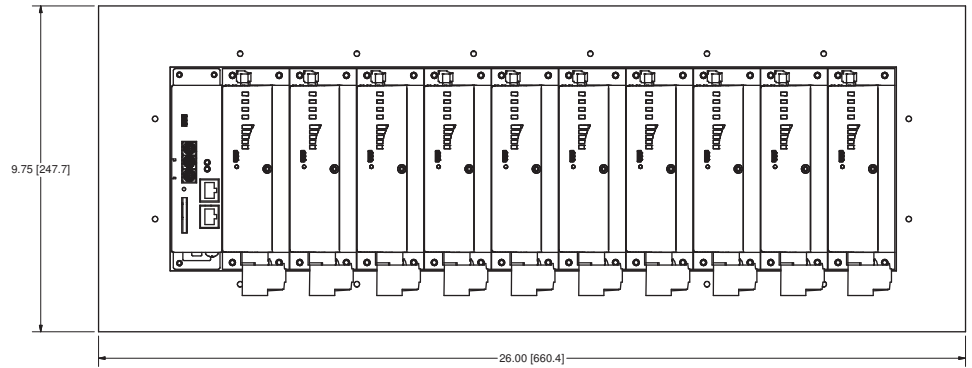
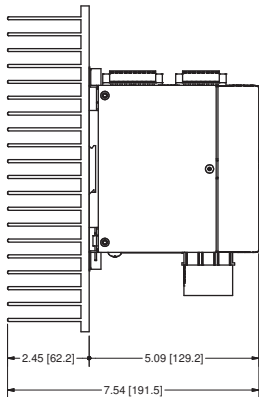
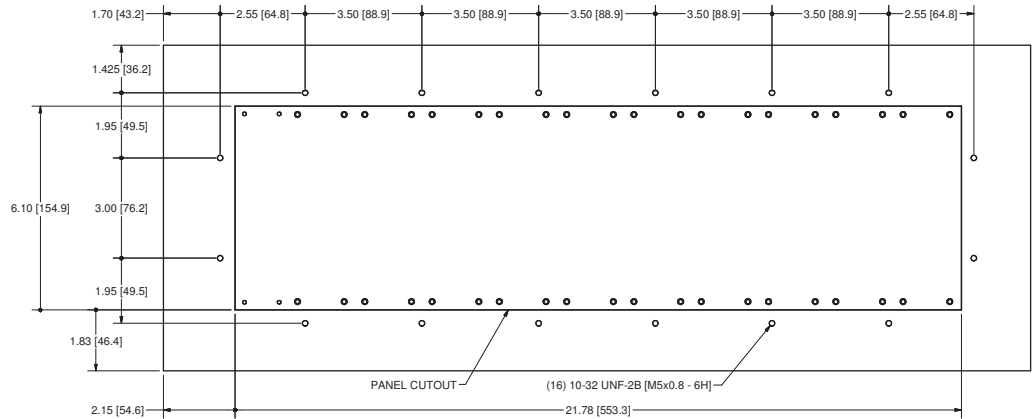

2.1.6 Three Position - Liquid Cooled

Gasket included.
 Inlet/outlet: Use 1/4-18 NPT fittings.
 (1) 1/2" brass plug is shipped with the controller.
 See liquid-cooled connection for ratings.

PANEL MOUNT

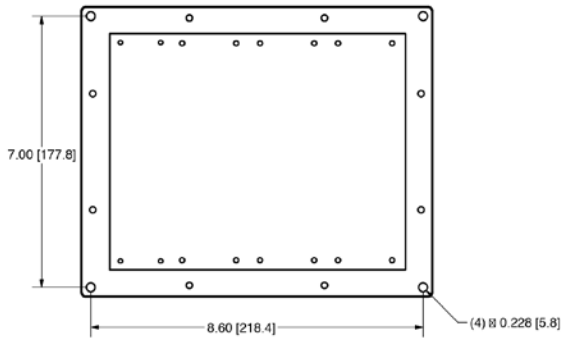

EXTERNAL MOUNT

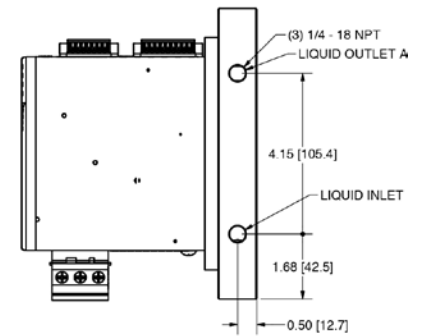
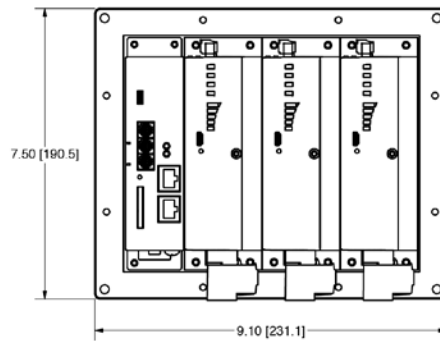
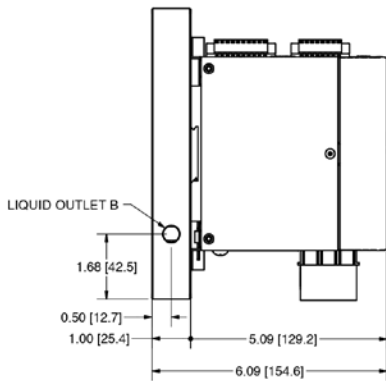
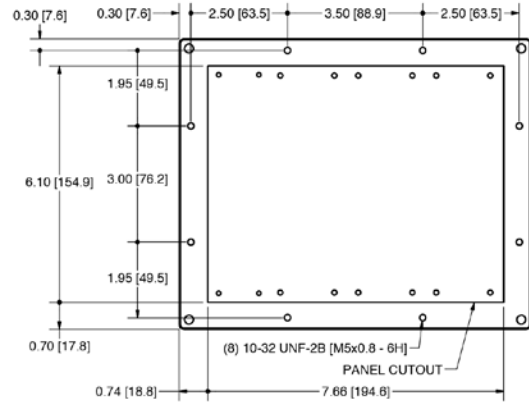

Layout for water inlet position

See Multizone Datasheet for ordering information.

Option L

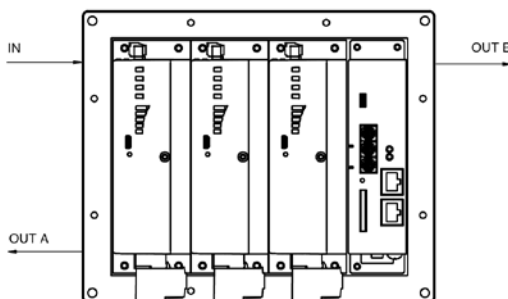

Option R

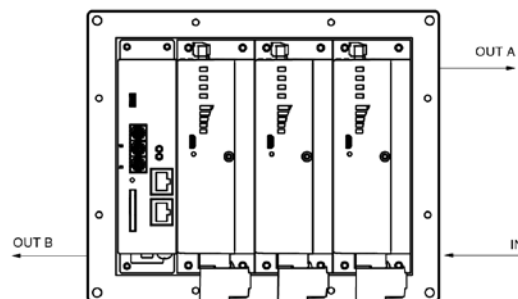

2.1.7 Six Position - Liquid Cooled

Gasket included.

Inlet/outlet: Use 1/4-18 NPT fittings.

(1) 1/2" brass plug is shipped with the controller.

See liquid-cooled connection for ratings.

PANEL MOUNT

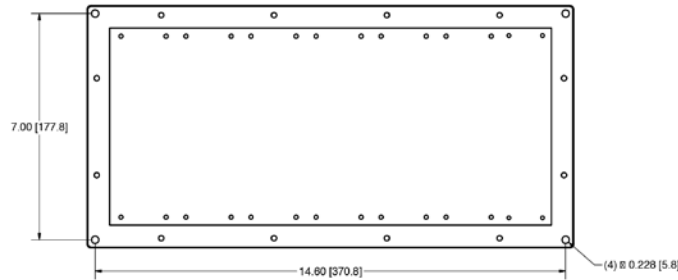

EXTERNAL MOUNT

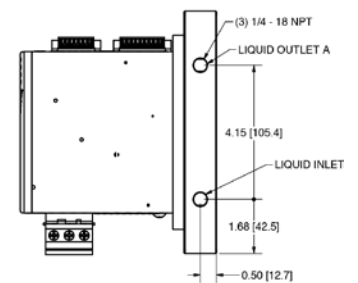
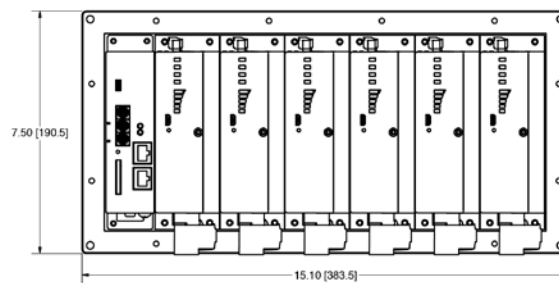
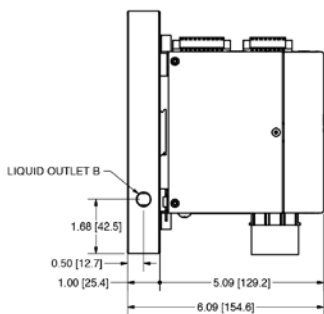
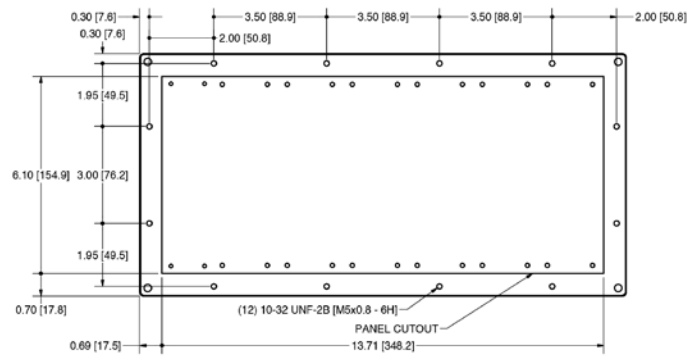

Layout for water inlet position

See Multizone Datasheet for ordering information.

Option L

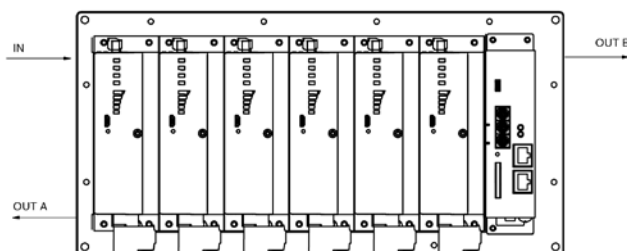

Option R

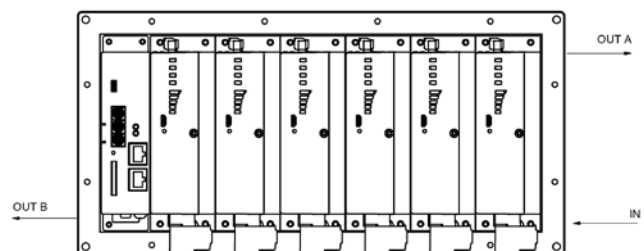

2.1.8 Ten Position - Liquid Cooled

Gasket included.

Inlet/outlet: Use 1/4-18 NPT fittings.

(1) 1/2" brass plug is shipped with the controller.

See liquid-cooled connection for ratings.

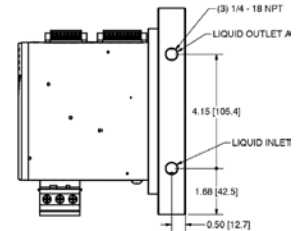
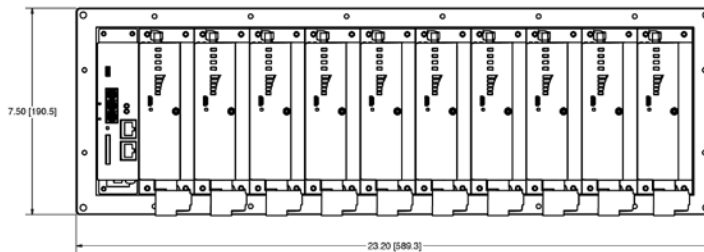
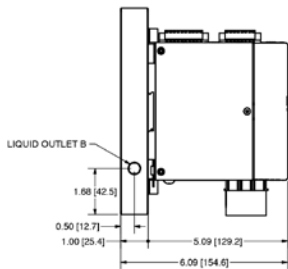
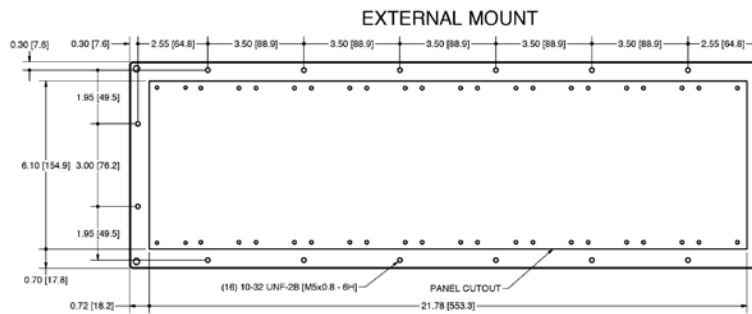
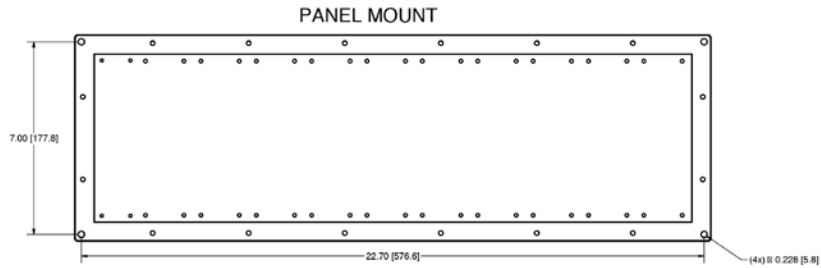

Layout for water inlet position

See Multizone Datasheet for ordering information.

Option L

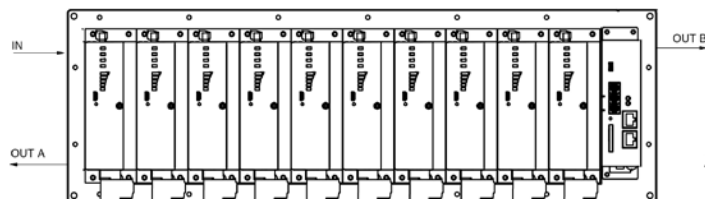

Option R

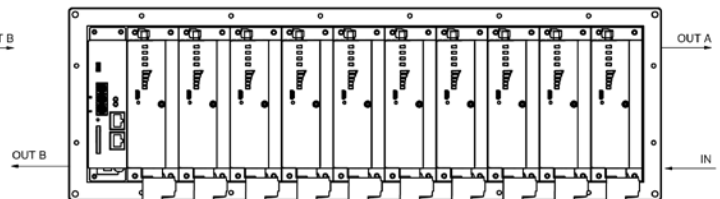

2.1.9 Three Phase External Mount Heatsink (16 - 50 Amps)

Dimensions:
Inches [mm]

Height
12.00 [304.8]
Width
9.75 [247.7]
Depth
5.47 [138.9]

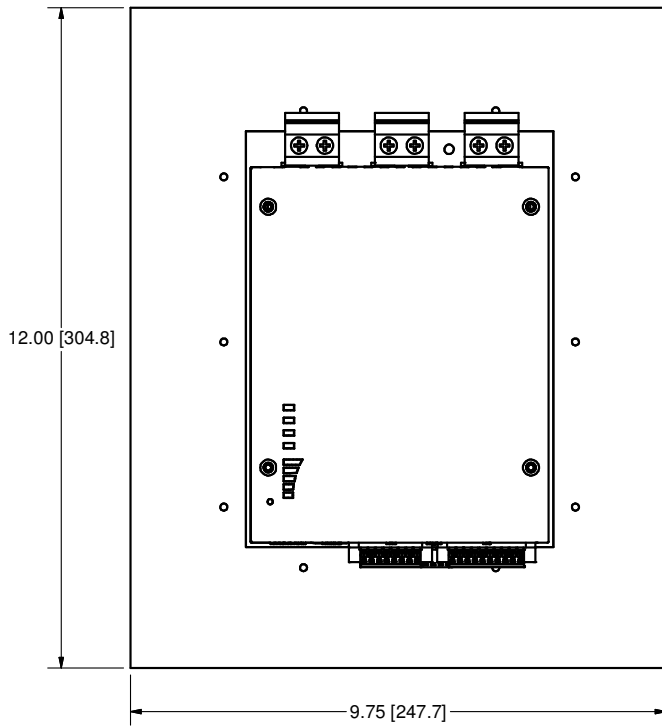

Note: Fins must be mounted vertically.

Gasket and gasketed washers included.

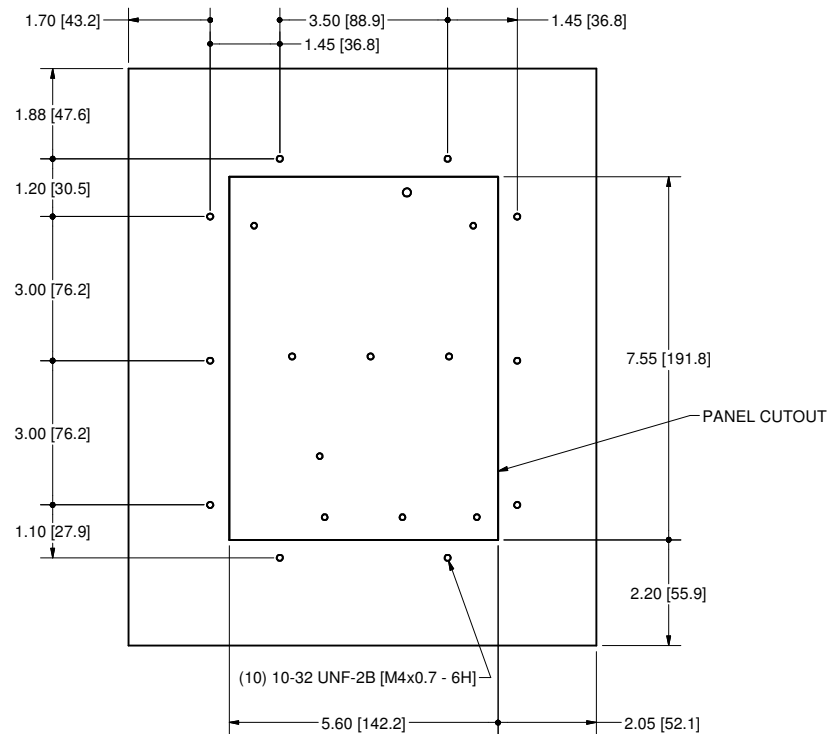
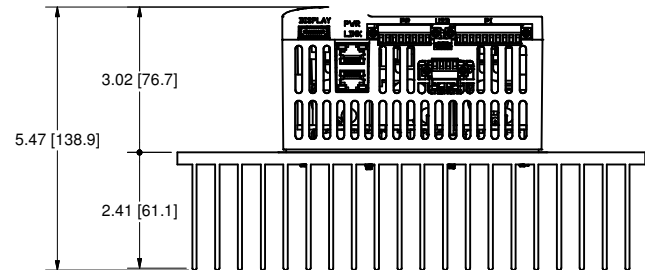

2.1.10 Three Phase Liquid Cooled Heatsink (16 - 80 Amps)

Dimensions: Inches [mm]

Gasket included.
 Inlet/outlet: Use 1/4-18 NPT fittings.
 (1) 1/2" brass plug is shipped with the controller.
 See liquid-cooled connection for ratings.

Height
6.00 [152.4]
Width
3.25 [82.55]
Depth
5.10 [129.54]

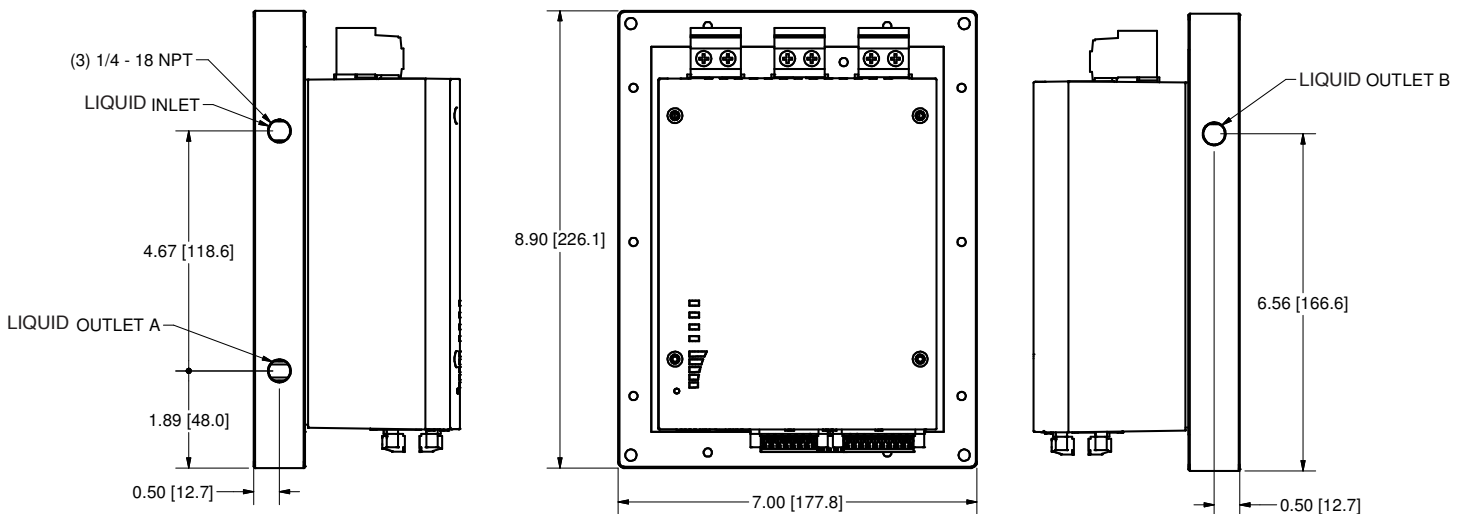
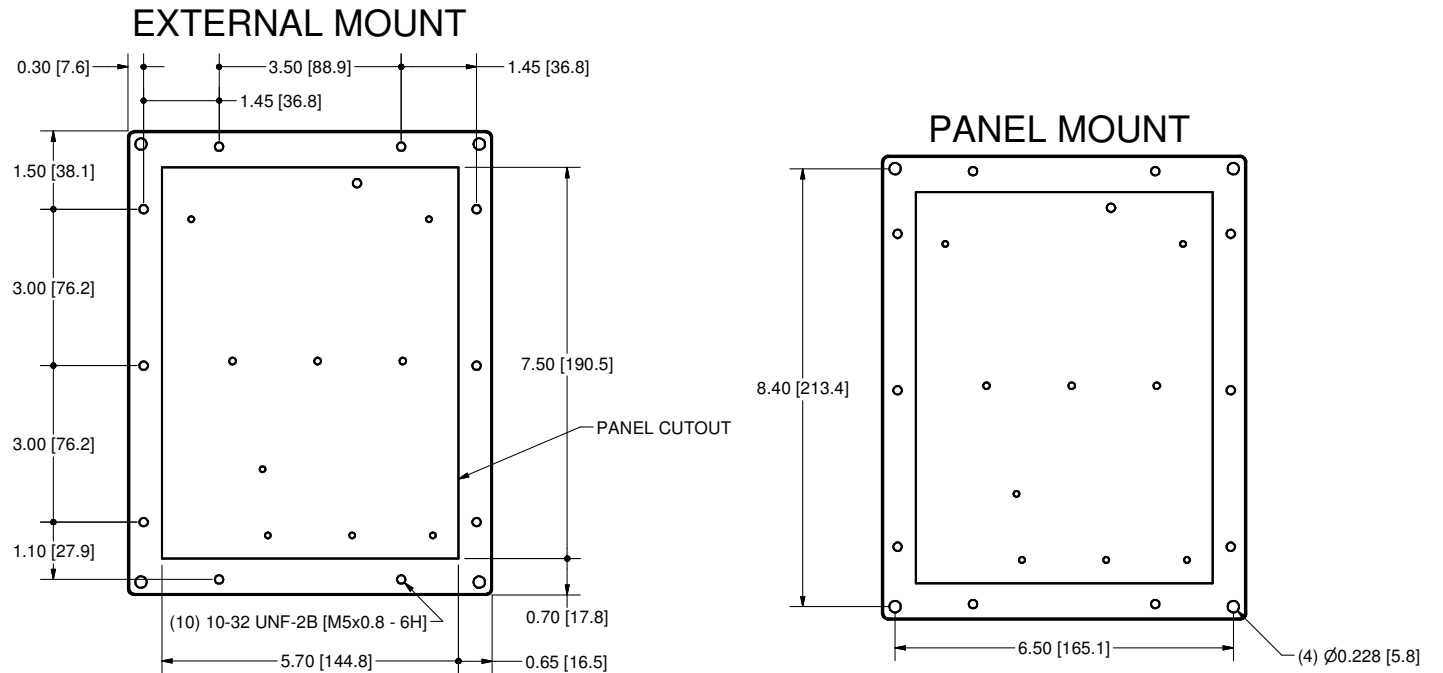

2.2 External and Panel Mounting

External and Panel mount options help to reduce the internal temperature of the enclosure that the controllers are mounted in. There is a finned heatsink that is intended to be mounted externally only. There is also a liquid cooled heatsink that can be mounted externally or within the panel.

When mounting externally, a cutout needs to be made in the side of the enclosure (see panel cutout dimensions in section 2.1). When the heatsink is mounted on the outside of the panel, the controllers remain inside the panel. All of the electrical connections are made within the enclosure. With liquid cooled heatsink remaining on the outside of the enclosure, all of the liquid connection remain on the outside, away from all electrical connections.

Mounting hardware is not provided due to varying panel thicknesses and multiple mounting options. With the finned heatsink gasket washers are provided to make proper seals for the UL ratings. A gasket that mounts to the heatsink and surrounds the controllers is also provided to keep contaminants outside the enclosure and is required for both the finned and liquid cool heatsinks for the UL ratings.



Figure 1: Controllers mounted through the side of the enclosure.

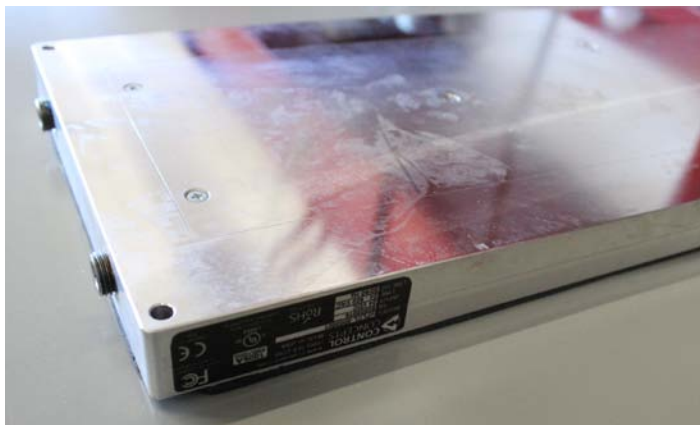

Figure 2 & 3: The controllers are mounted such that the heatsinks are on the outside of the enclosure.

The heatsink is mounted directly to the back plate of the enclosure. Use the (4) mounting holes in the corners of the heatsink. With this type of mounting, the liquid connections to the heatsink are made inside of the panel.



Figure 4: Mounting liquid cooled heatsink inside of an enclosure.
Note: Liquid connections are not present in photograph.

2.3 Mounting Instructions

Finned External Mount

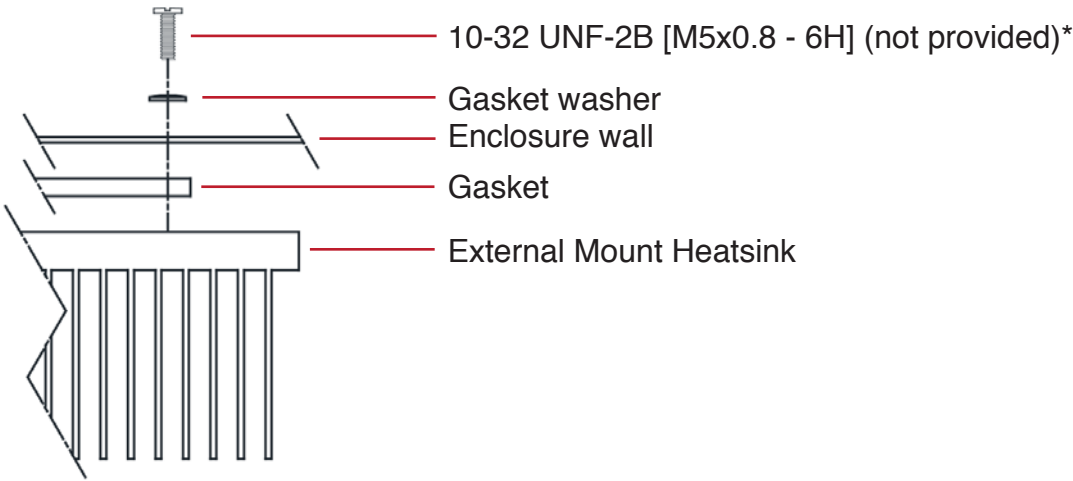

*Tighten to 32 in/lbs [3.6 Nm] to ensure proper seal for gasketed washer. Do not over tighten, damage may occur to washer. Gasket should compress approximately 50%

Liquid External Mount

Recommended

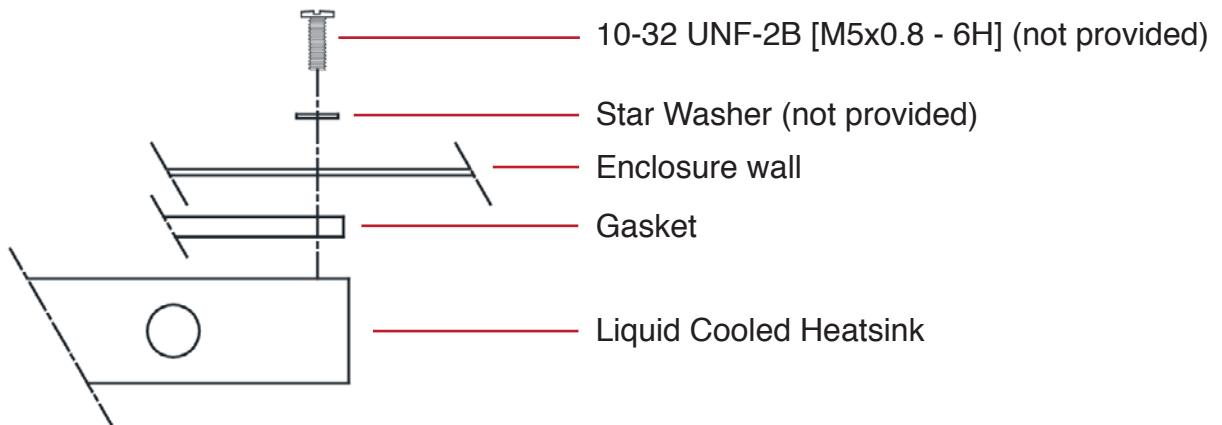

Note: Gasket should be compressed approximately 50%. All water connections are kept outside of the panel.

Liquid Panel Mount

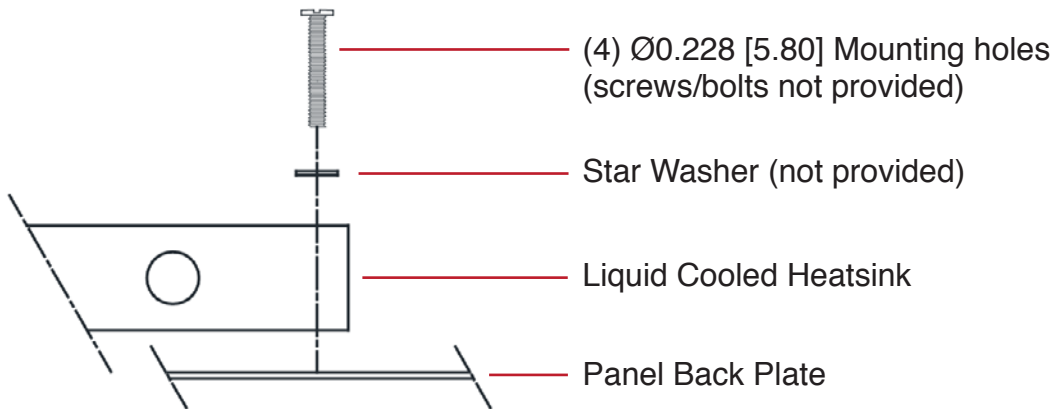

Note: All water connections are internal. A gasket is not used.

The gasket has an adhesive on one side. It is intended to be installed on the heatsink prior to the final installation of the heatsink on the enclosure. This is to prevent any damage to the gasket during shipping or initial stages of installation.

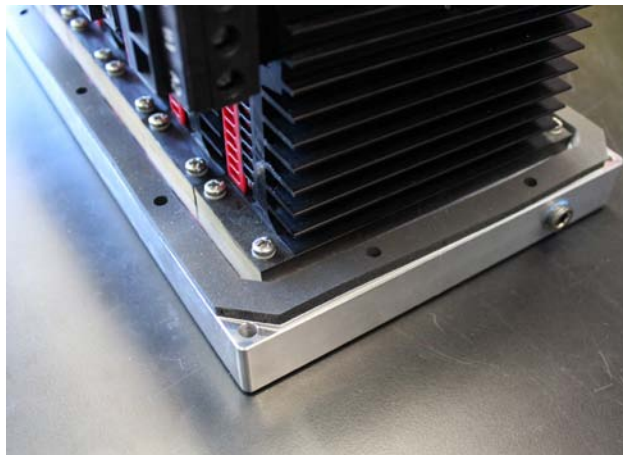

Figure 5: Adhering gasket to heatsink

2.4 Liquid Cooled Connections

There are three 1/4-18 NPT and each heatsink is shipped with 1 brass plug (not installed). Use the outlet that is most convenient for panel layout and use the plug in the other. Multiple liquid cooled can be connected together as long as the liquid is operating under the rated specifications.

Liquid Cooled Ratings

Description	Rating
Pressure (Max)	60 PSI [4.137 BAR]
Flow Rate	1 GPM [3.79 LPM]
Inlet Temperature (Max)	122° F [50° C]

3. WIRING

Control Concepts configures and tests each controller before shipping. Once received, the controller is ready to install. The following sections will describe how to properly wire the unit with the recommended fusing.

For line and load connections use copper conductors rated 75°C minimum. See torque tables for proper tightening.

A ground wire is recommended for proper operation. Use 10 AWG or larger wire.



Note: Wire controllers to conform with the National Electric Code (NEC) and/or other local wiring codes.

3.1 Torque Specifications

Recommended Tightening Torque For Line/Load Connectors	
Wire Size (AWG)	Torque
3 - 14	24 IN-LBS [2.70 Nm]

Recommended Tightening Torque For P1/P2 Connectors		
Number of wires	Wire Size (AWG)	Torque
1	16 - 26	3.0 IN-LBS [0.34 Nm]
2	20	3.0 IN-LBS [0.34 Nm]

3.2 AC Line / Load Connections

3.2.1 Single Phase

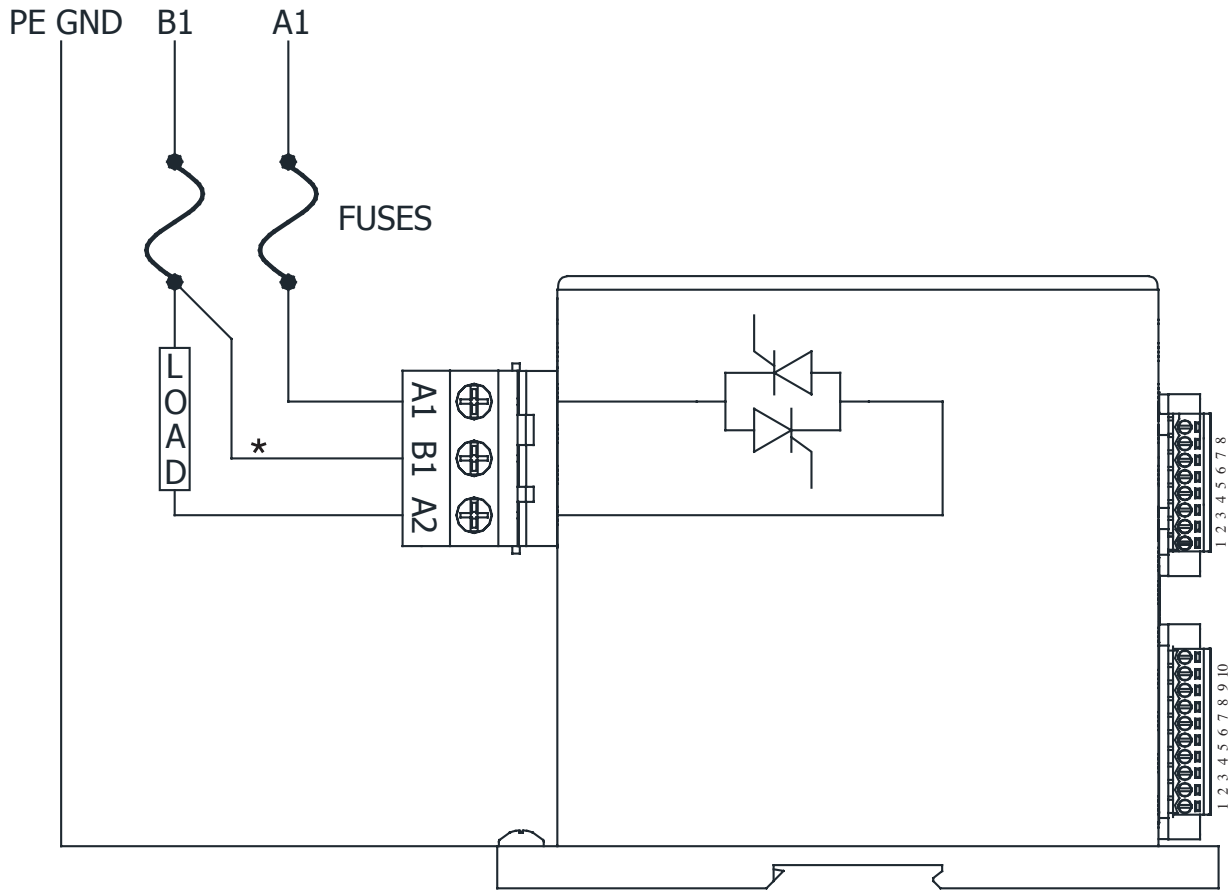

*Note: 0.60 mA maximum through B1 connection at 600 Vac
14 AWG Minimum wire size required for connector

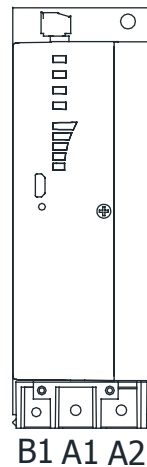

B1 uses #6 or M3.5 ring terminal.
A1 and A2 use #10 or M5 ring terminal.
See drawing above for wiring

3.2.2 Three Phase, 2 Leg

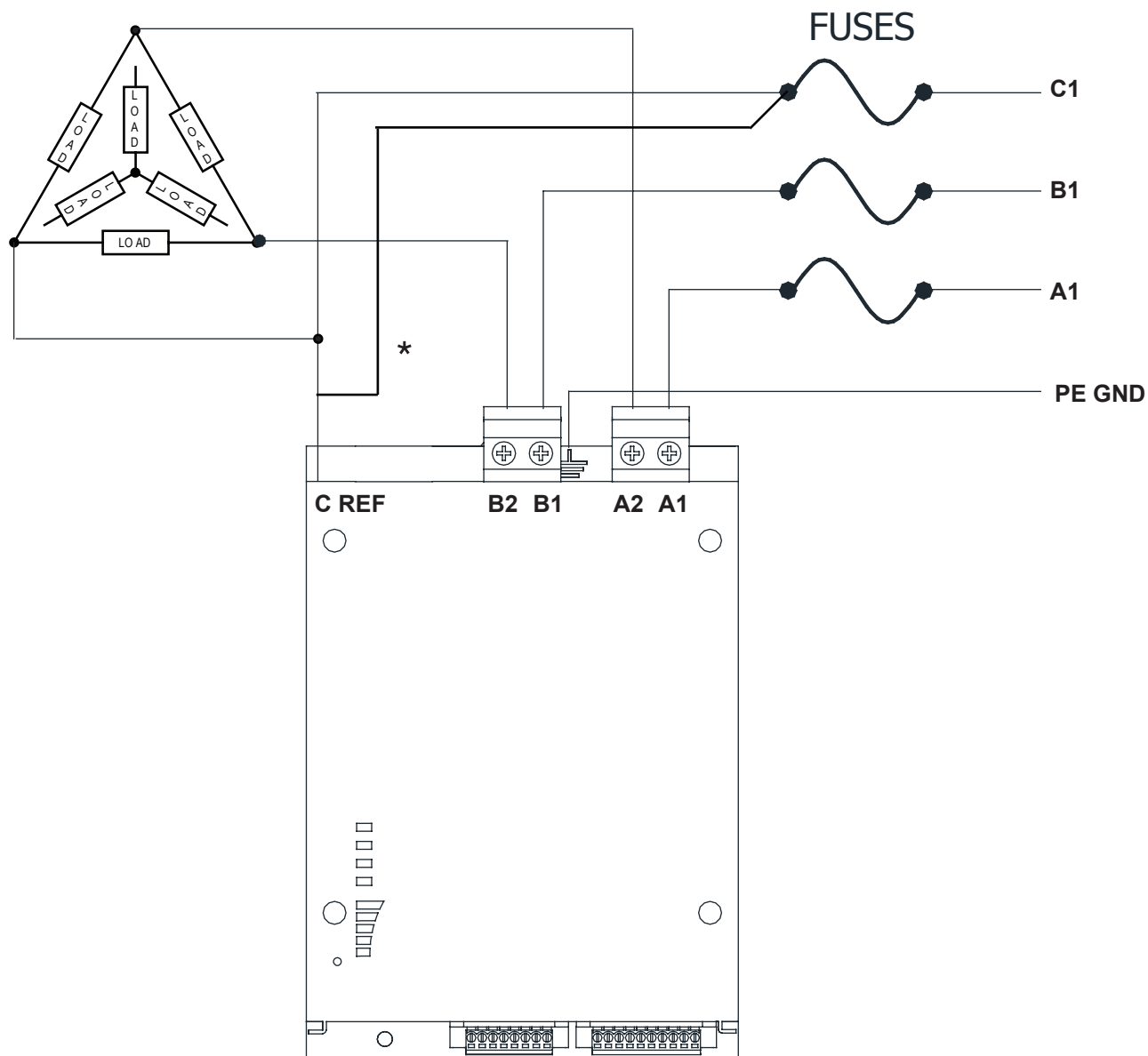

* Note: 0.60 mA maximum through C Ref connection at 600 Vac.

3.2.3 Three Phase, Delta or Wye

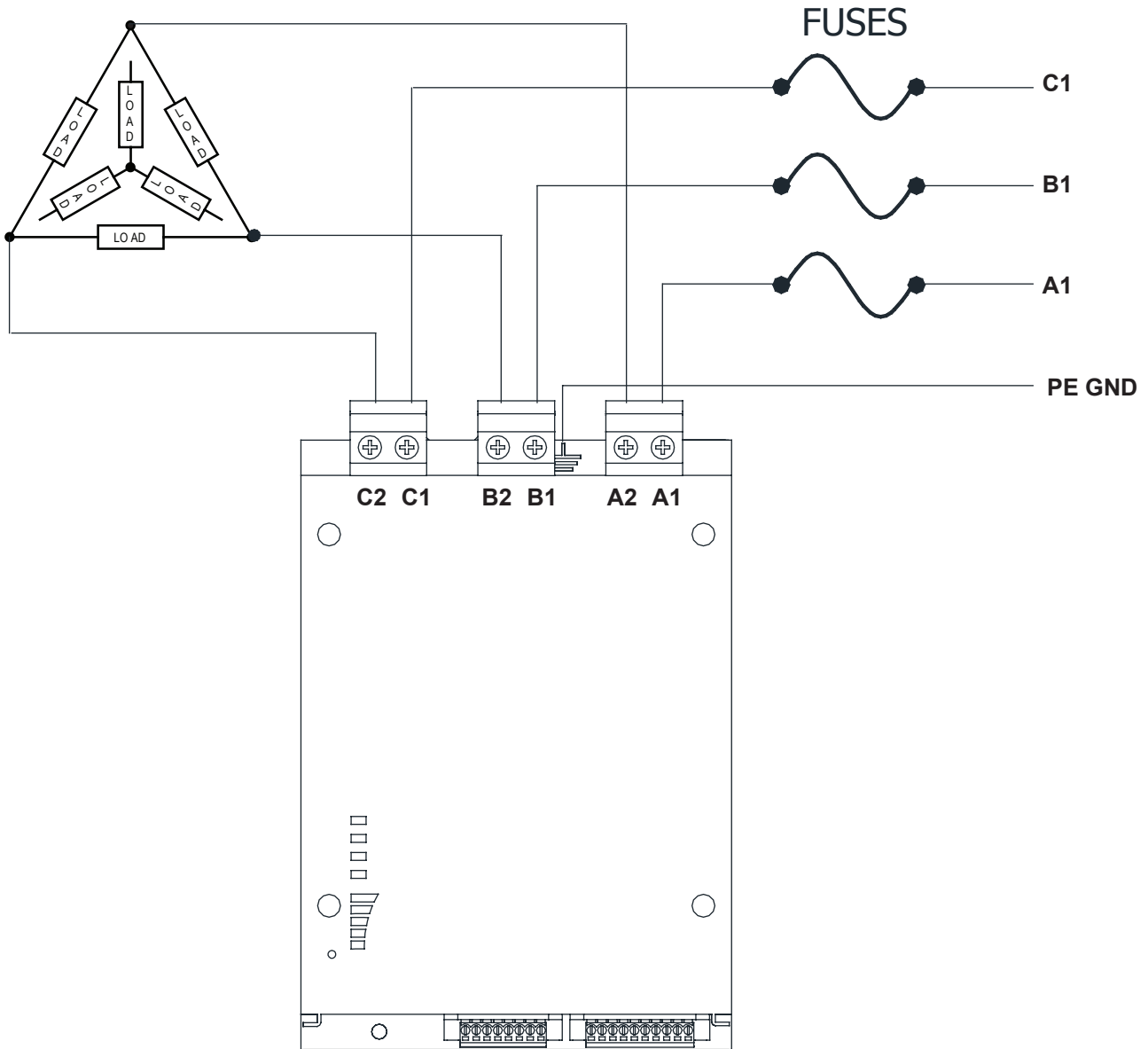

3.2.4 Three Phase, Four Wire Wye

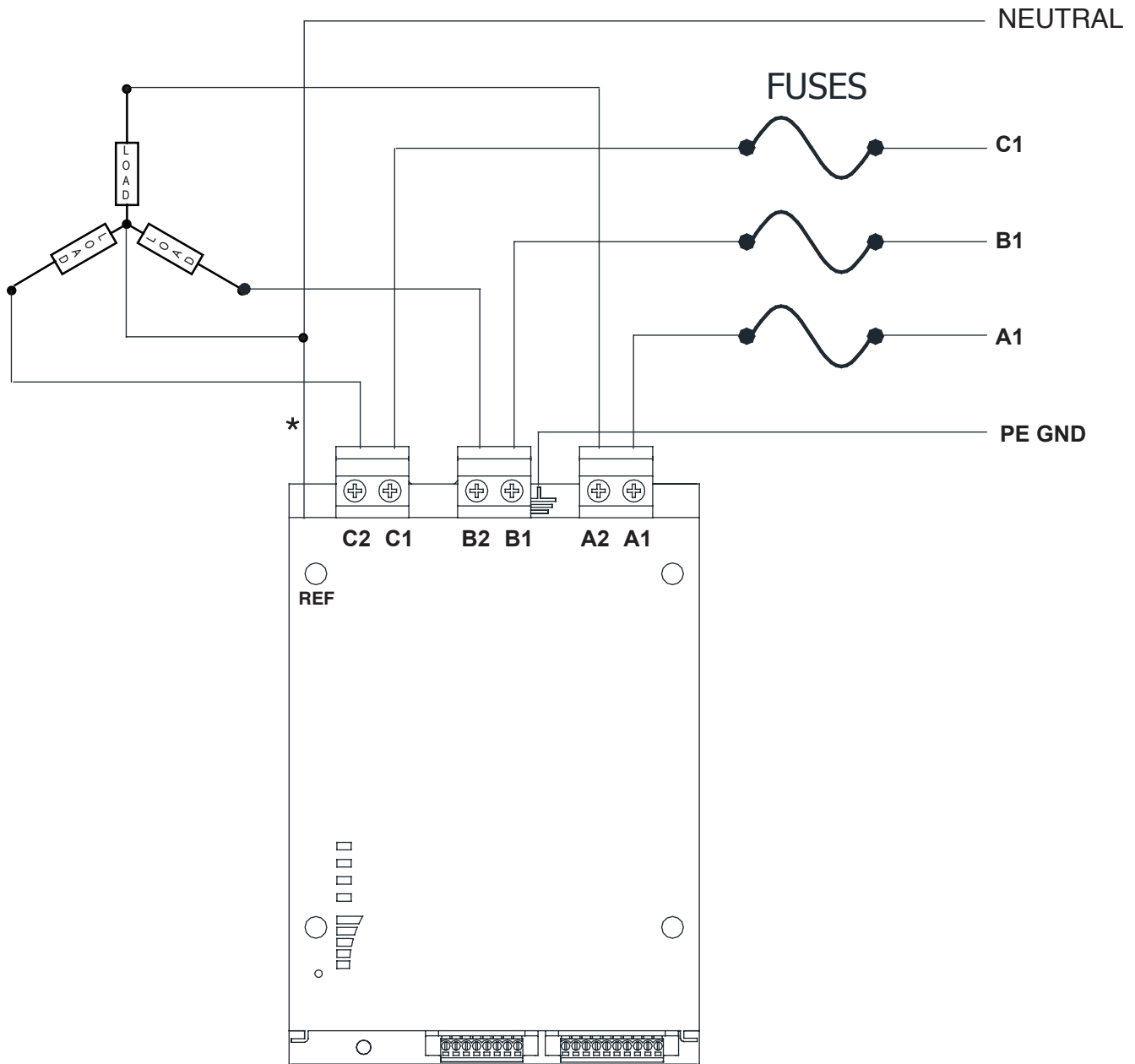

* Note: 0.60 mA maximum through Ref connection at 600 Vac.

The MicroFUSION controllers normally display line and load voltages from Line to Line. When the controller is in 4 Wire Wye operation the line voltages read Line to Line while the load voltages read Line to Neutral.

3.2.5 Three Phase, Inside Delta

When wiring this controller it must be wired as per the diagram.
 Load A must return to Line B.
 Load B must return to Line C.
 Load C must return to Line A.

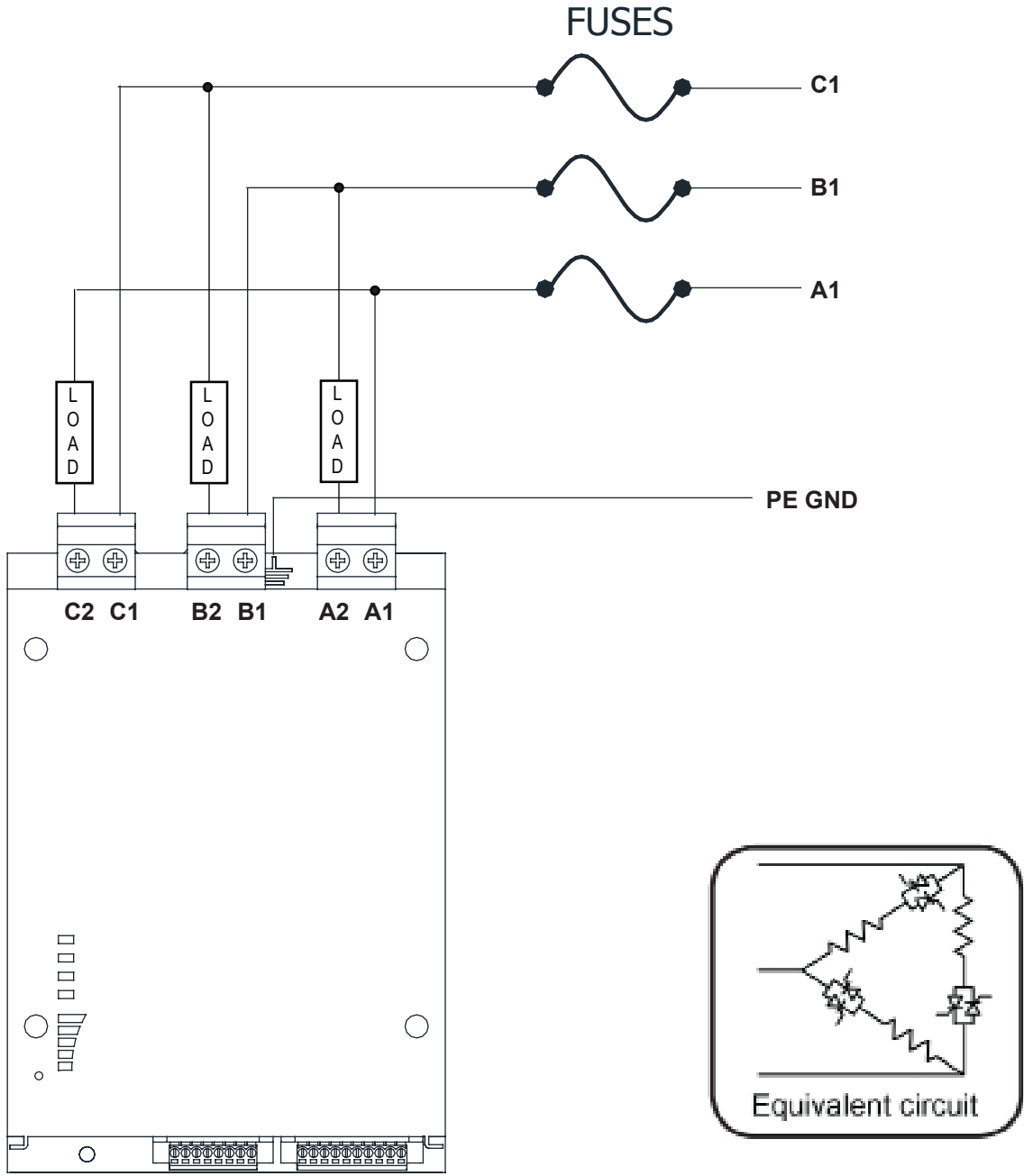

3.3 Connectors

3.3.1 P1-10 Pin Command Connector

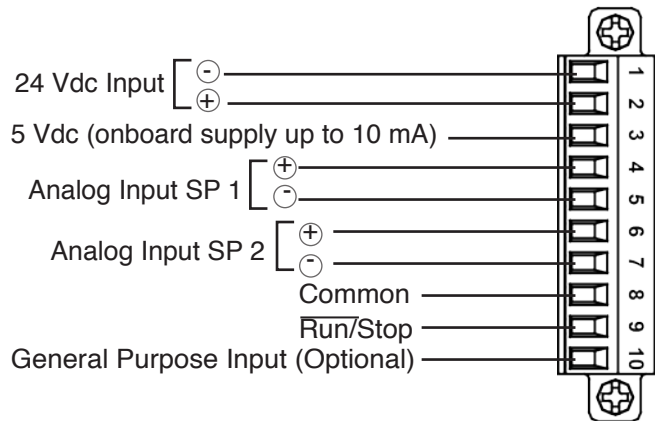

3.3.2 P2-8 Pin Command Connector

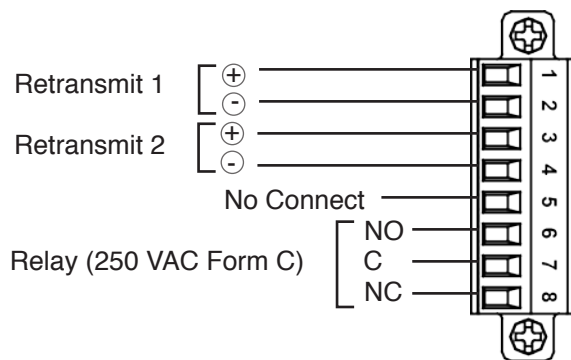

4. INDICATOR LEDs

See chart below for LED Colors and indicated Operation.

24VDC	
Green	+24 Vdc present
Red	+24 Vdc wired backwards

LINE OK	
Off	No AC Line V
Green	Ok, Locked
Orange	Boot Segment
Red	Phase Lock Loss

LIMIT	
Off	Ok, No Limits
Orange	Voltage Limit
Red	Current Limit
Flash between Red/Green	Power Limit

ALARM	
Off	Ok, No Alarms, Not in RUN
Green	Ok, No Alarms, in RUN
Orange	Warning Alarm
Red	Inhibit Alarm

OUTPUT	
Green	LEDs turn green in proportion to output
Top LED Red	Indicates 100% on



5. USB INTERFACE

5.1 USB Interface

A MicroUSB interface is standard on all controllers. Included with each controller is a software package titled 'MicroFUSION Control Panel'. This allows the user to connect to the controller using a computer and MicroUSB cable.

Control Concepts stocks 15 foot USB cables for customers to purchase (P/N: 0058006-0000-15).

6. OPTION BOARD

6.1 Internal Factory Industrial Communications

A fieldbus interface options can be used to communicate with a PLC or factory control system. PROFINET, Modbus TCP, and EtherNet/IP are available as internal fieldbus options.



Note: Only one type of interface is available per unit. For example a controller with Modbus RTU cannot also have Modbus TCP.

Control Concepts highly recommends the use of shielded wiring and offers a variety of lengths to purchase.

6.2 External Factory Industrial Communications

DeviceNet™, EtherNet/IP, EtherCAT, PROFINET, Modbus RTU (RS-485), or Modbus TCP are available through an external module. Furthermore, a single external network module can control up to 10 zones, reducing system installation costs.

Control Concepts highly recommends the use of shielded wiring and offers a variety of lengths to purchase.

See Fieldbus module in the Accessories section of this manual for more details.

7. PERFORMANCE

7.1 Feedback [SP 1]

	SX-S	SX-L	HX-L	HX-P
FF Voltage¹	Standard	Standard	Standard	Standard
RMS Voltage²			Standard	Standard
AVG Voltage			Standard	Standard
RMS Current	Optional	Standard	Standard	Standard
AVG Current	Optional	Standard	Standard	Standard
Real Power			Optional	Standard
Apparent Power			Optional	Standard

¹ Default for SX

² Default for HX

The Feedback type determines the control loop feedback.

FF Voltage – Use RMS Voltage based on line voltage as the control loop feedback.

RMS Voltage – Use RMS Voltage as the control loop feedback.

AVG Voltage – Use average voltage as the control loop feedback.

RMS Current – Use RMS current as the control loop feedback.

AVG Current – Use average current as the control loop feedback.

Power – Use real power as the control loop feedback

Apparent Power – Use apparent power as the control loop feedback.

7.1.1 Feedback Type Calculations

Here are the formulas for how the feedback is measured:

RMS Voltage

$$V_{rms} = \sqrt{\frac{\sum_{i=1}^n (Vi)^2}{n}} \approx 0.707 V_{pk}$$

RMS Current

$$I_{rms} = \sqrt{\frac{\sum_{i=1}^n (Ii)^2}{n}} \approx 0.707 I_{pk}$$

Power

The output is adjusted via the real Power.

$$\text{Real Power} = \frac{\sum_{i=1}^n (Vi * Ii)}{n}$$

AVG Voltage

$$V_{avg} = 1.11 \frac{\sum_{i=1}^n |Vi|}{n} \approx 0.707 V_{pk}$$

AVG Current

$$I_{avg} = 1.11 \frac{\sum_{i=1}^n |Ii|}{n} \approx 0.707 I_{pk}$$

$$\text{Apparent Power} = V_{rms} * I_{rms}$$

$$\text{Power Factor} = \frac{\text{Real Power}}{\text{Apparent Power}}$$

V_{pk} = Peak Voltage I_{pk} = Peak Current
 Vi = Instantaneous Voltage sample Ii = Instantaneous Current sample
 n = number of samples in 1 AC line cycle

7.1.2 External Feedback

External feedback uses an external analog signal to represent the output to the load. These types of signals often come from a transducer that measures voltage, current, temperature or power and scales it proportionally to a 0 – 5 Vdc or 4 – 20 mA signal.

Connect the external feedback signal to an analog setpoint. Select the correct Feedback Source (SP19). Scale the external feedback by setting up the analog setpoint via the Analog I/O tab of the Control Panel software.

7.1.3 Feedback Source [SP19]

	SX	HX
Internal	* Included	* Included
Analog SP1	Included	Included
Analog SP2	Optional	Optional

*** = default**

The Analog SP2 source is only available if the I/O section of the model number contains a “2”, “3”, “6”, or “7.”

This selects the type of feedback used. For external feedback select Analog SP1 or SP2.

7.2 Firing Mode [SP 2]

	SX	HX
Zero Cross	Included	* Included
Phase Angle	** Included	** Included
Zero Cross Transformer	N/A	Optional

* = default for three phase 2 leg

** = default for all other models

The Zero Cross Transformer mode is only available if the Zero Cross Transformer Mode section of the model number contains a "Z".

Knowing the application and the type of load you are trying to control is critical for choosing the right mode of operation. The MicroFUSION Series power controllers are capable of Phase Angle, Zero Cross, and ZCT operations. The following sections will describe each type of operation and will show the expected output.



Note: For proper load operation, correct wiring is critical. See the "Wiring" section of the Installation & Maintenance Manual.

7.2.1 Phase Angle

In phase-angle control, each SCR of the back-to-back pair is turned on for a variable portion of the half-cycle that it conducts. Power is regulated by advancing or delaying the point at which the SCR is turned ON within each half cycle. Light dimmers are an example of phase-angle control.

Phase-angle control provides a very fine resolution of power and is used to control fast responding loads such as tungsten-filament lamps or loads in which the resistance changes as a function of temperature.

Single Phase Operation

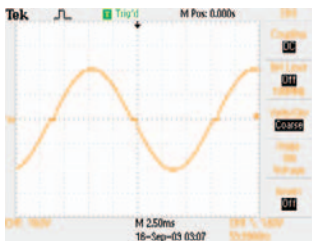

100% Load Power

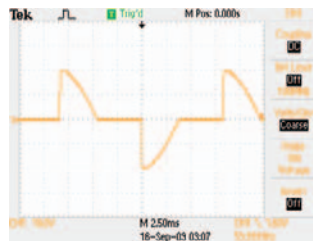

50% Load Power

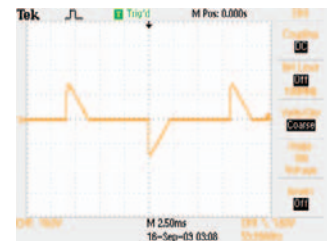

25% Load Power

Three Phase Operation

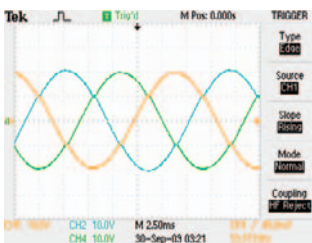

100% Load Power

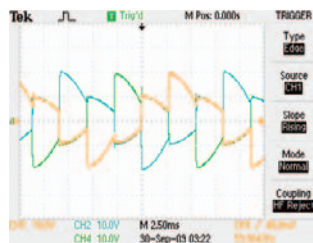

50% Load Power

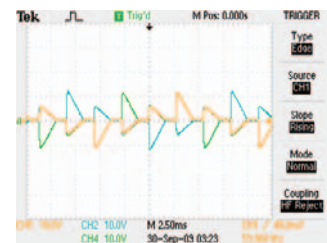

25% Load Power

7.2.2 Zero Cross

In zero-cross control, load power is turned ON and OFF only when the instantaneous value of the sinusoidal waveform is zero. Load power is controlled by switching the SCRs “ON” for a number of complete electrical half-cycles, and then “OFF” for a number of complete electrical half-cycles.

The wave form in the top left shows the 1 phase AC waveform into the controller. This would also be the representation of the output with the command at 100%. The rest of the waveforms show the “ON” and “OFF” cycles of the output at various setpoints.

The tabulation on the right shows the sequence of “ON” and “OFF” electrical half-cycles that are applied to the load to achieve the percentage of load power indicated. The percentage of load power is equal to; the ratio of the number of electrical half-cycles that power is applied, to the total number of electrical half-cycles.

From the tabulation, it can be seen that power is applied for 16 out of 32 electrical half-cycles to achieve 50% load power and that power is applied for 136 out of 160 electrical half-cycles to obtain 85% power. When operating with a 60 Hz supply, the sequence of ON and OFF cycles repeats 0.266 seconds on 50% and every 1.33 seconds at 85% power.

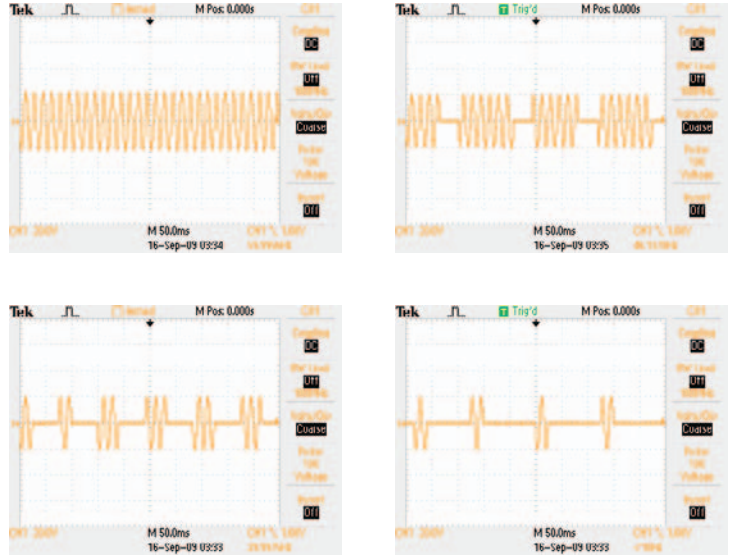

LOAD POWER TIMING				
10%	25%	50%	75%	85%
5 ON	5 ON	9 ON	17 ON	23 ON
46 OFF	14 OFF	8 OFF	6 OFF	4 OFF
5 ON	5 ON	7 ON	19 ON	23 ON
44 OFF	16 OFF	8 OFF	6 OFF	4 OFF
				23 ON
				4 OFF
				23 ON
				4 OFF
				23 ON
				4 OFF
				21 ON
				4 OFF



Note: Even though it takes 1.33 seconds to obtain precisely 85% power, the load power during the 23 ON and 4 OFF cycles is 23/27 or 85.185% power and this cycle is repeated every 0.225 seconds.

7.2.3 Zero Cross Transformer Mode (ZCT)

This is a Control Concepts proprietary algorithm that uses hybrid control to avoid the excessive inrush currents that can occur when firing into inductive or variable resistive loads.

In this firing mode the (on-off) duty cycle is adjusted to obtain the desired amount of power to the load. The “ON” portion of the output begins with a set number of cycles that increase to full conduction, then it remains at full conduction for a number of cycles, and then turns off. This pattern restarts with each subsequent duty cycle.

When utilizing the “Zero Cross Transformer” (ZCT) firing mode, the Power Factor measured by the controller is typically 0.90 with a setpoint that is greater than or equal to 50%. When the setpoint is less than 50% the controller will maintain a measured Power Factor of approximately 0.70.

Current Limit is enabled during the “phase-up” section of each “ON” portion of the duty cycle. A Power Factor of 0.90 (Setpoint > 50%), or 0.70 (Setpoint < 50%), may not be able to be achieved if the controller was current limiting the output to the load during the phase-up time.

Set-up

After connecting the MicroFUSION controller to the MicroFUSION Control Panel Software, click on the Zone 1 tab. Set the Firing_Mode to ZeroCross_Transformer. Set the Phase_ZC_Switch_Time to the desired number of cycles the controller will use to ramp up to full conduction. This parameter is adjustable from 5 to 20 cycles (default is 20 cycles). If the controller is firing into a transformer, the value entered should be set high enough so that the transformer does not saturate during the start section of the “ON” portion of the duty-cycle.

Transformer Selection

A transformer of at least 1.3 Tesla (13000 Gauss) is preferred for best performance, up to 1.5 Tesla (15000 Gauss) is permissible.

7.3 Control Mode [SP 3]

* = default	SX	HX
Open Loop	Included	Included
Closed Loop	* Included	* Included

Closed Loop adjusts the output so that the feedback equals the setpoint. When using Open Loop the output percentage is directly proportional to the setpoint. The feedback is not used.

7.4 Full Scale Settings

7.4.1 Full Scale Voltage [SP 8]

The Full Scale Voltage is the voltage that will be applied when the load is at full capacity. The closer the Full Scale Voltage is to the actual voltage, the more accurate the controller will be. Setting this slightly higher than the actual voltage is common. This should not be set to more than 2X the actual voltage. The factory default is set to 480 V.

7.4.2 Full Scale Current [SP 9]

The Full Scale Current is the current that the load will draw when the load is at full capacity. The closer the Full Scale Current is to the actual current, the more accurate the controller will be. Setting this slightly higher than the actual current is common. This should not be set to more than 2X the actual current. The factory default is set to the frame rating of the controller.

7.4.3 Full Scale Power [SP 10]

The Full Scale Power is the power consumed by the load when at full capacity. This should not be set to more than 2X of the actual power. The default value is calculated from the following:

1 Phase AC	3 Phase AC	
	Delta, 3 & 4 Wire Wye	Inside Delta
$[\text{Full Scale V}] \times [\text{Full Scale I}]$	$[\text{Full Scale V}] \times [\text{Full Scale I}] \times [\sqrt{3}]$	$[\text{Full Scale V}] \times [\text{Full Scale I}] \times [3]$



Note: In the MicroFUSION Control Panel Software there is a “Calculate” button for these equations. This will automatically fill in the full scale power once pressed. It will also automatically set up the limit settings.

7.5 Setpoints

	SX	HX
Digital Fieldbus	Included	Included
Digital Keypad	Included	Included
Analog SP1	* Included	* Included
Analog SP2	optional	optional

* = default

The Analog SP2 is only available if the I/O section of the model number contains a “2”, “3”, “6”, or “7.”

There are four possible setpoints: two digital and two analog. To designate which setpoint the controller uses, the Setpoint Source (SP102, SP103) and Control Setpoint Select (SP104) need to be setup within the System Tab of the Control Panel software.

7.5.1 Setpoint Source [Setpoint 1 Source] & [Setpoint 2 Source]

	SX	HX
Analog SP1	Included	Included
Analog SP2	Optional	Optional
Digital Fieldbus	Included	Included
Digital Keypad	Included	Included
PWM Input	Optional	Optional

The Analog SP2 and the Pulse Width Modulated (PWM) input are only available if the I/O section of the model number contains a “2”, “3”, “6”, or “7.”

There are two setpoints that can be configured. They can both be set to digital, or both to analog or a combination of either analog or digital. The controller will use the Control Setpoint Select (SP104) parameter to determine which setpoint to use.

Defaults:

- SP102 Setpoint 1 Source: Analog SP1, or Digital Fieldbus if a communication module is onboard.
- SP103 Setpoint 2 Source: Analog SP2, or Digital Keypad if the Analog SP2 feature is not enabled.

For a PWM input the signal must be connected to Analog SP1.

7.5.2 Control Setpoint Select [SP104]

	SX	HX
Setpoint 1 Source [SP102]	Included	Included
Setpoint 2 Source [SP103]	Included	Included

The Control Setpoint Select determines which setpoint source the controller will use. The setpoint source is configured using Setpoint 1 & 2 Source (SP102 & SP103). By default this is set to Setpoint 1 Source.

7.5.3 Digital Setpoints [SP100] & [SP101]

There are two digital setpoints (Fieldbus, Keypad). The setpoints can be sent via USB, a fieldbus interface, or from the remote display keypad.

When using digital setpoints the Digital Run/Stop (SP129) must be used.

7.5.4 Digital Run/Stop [SP129]

When using a digital setpoint Digital Run/Stop must be enabled. It is common for this to be set to “Run (1)” whenever a setpoint is assigned. The Digital Run/Stop Power-up Default (SP3401) parameter found on the System Tab may be used to always have the Digital Run/Stop set to “Run (1).” This is applied to Digital Run/Stop (SP 129) during a processor reset or power cycle.

7.5.5 Setpoint Resolution [SP115]

	SX	HX
10000 counts	* Included	Included
64000 counts	N/A	* Included

* = default

The Setpoint Resolution sets the setpoint entry value that equates to 100% output
The count value equates to:

0 counts = 0% output

SP115 setting (10000 or 64000) = 100% output

7.5.6 Analog Setpoints

	Default	Range
Analog SP1 (Vdc)	0 – 5 Vdc	0 – 10 Vdc
Analog SP1 (mA)	* 4 – 20 mA	0 – 20 mA
Analog SP2 (Vdc)	* 0 – 5 Vdc	0 – 10 Vdc
Analog SP2 (mA)	4 – 20 mA	0 – 20 mA

* = default

The Analog SP2 is only available if the I/O section of the model number contains a “2”, “3”, “6”, or “7.”

The inputs allow a wide array of input scaling for the user. The hardware capabilities are 0 – 10 Vdc for voltage and 0 – 20 mA for current. To make changes to the analog inputs, open the Control Panel software and check the Analog I/O Tab.

7.6 Run / Stop

This refers to pins 8 & 9 of the P1 connector. Pin 9 is directly connected to the gates and monitored by the processor. When pin 9 is pulled low (connected to pin 8), the output of the controller is enabled (Run state). With no connection between these two pins the controller will remain in a Stop state.

Run state does not mean the controller is outputting. Run state means the controller is able to output as long as a command/setpoint is present (digital or analog) and there are no inhibit alarms.

7.7 Limits and Trip Parameters

	SX	HX
Voltage Limit	N/A	optional
Current Limit	Included	Included
Over Current Trip	Included	Included
Power Limit	N/A	optional

The Limit and Trip parameters are only available if the Performance section of the model number contains an “L” or “P”.

These are safety features designed to help protect from excessive voltage, current and/or power being applied to the Load.

7.7.1 Voltage Limit [SP 11]

	SX	HX
Adjustable	N/A	optional

Limits the voltage applied to the load. The recommended setting is 105% of the full scale voltage. The default value is set to 630 Volts which is 105% of a 600 VAC frame voltage.

7.7.2 Current Limit [SP 12]

	SX	HX
Fixed	Included	N/A
Adjustable	optional	Included

To adjust the Current Limit value for SX models the Performance section of the model number must contain an “L”.

This limits the current applied to the Load. The recommended setting is 105% of the full scale current. The default value is set to 105% of the frame rating. The current can be limited by the RMS or AVG value. Use the Current Limit Type parameter [SP13] to change between RMS or AVG.

7.7.3 Over Current Trip [SP 14]

	SX	HX
Adjustable	Included	Included

If the current exceeds the Over-Current Trip setting the controller will shut down. This responds faster than the Current Limit setting. When experiencing an Over-Current Trip the controller will disable the output and display the condition on the LED indicators and the remote display (if present). This feature is designed to protect the controller from experiencing surge currents that could damage the controller.

Recommended settings:

Phase Angle firing mode: 175% of frame rating.

Zero Cross firing mode: 350% of frame rating.

7.7.4 Power Limit [SP 15]

	SX	HX
Adjustable	N/A	optional

Limits the power applied to the load. The controller will continue to operate but will not exceed the power specified in this field. The recommended setting is 105% of the full scale power. The default value is set to 105% of the full scale power.

7.8 Tap Change Indication

Certain types of loads change resistance over their lifespan, which can affect the power factor when controlled with a phase angle power controller to achieve a constant output power. To improve power factor, a transformer with multiple voltage taps may be used. The tap change indication signals the user when to change these voltage taps to a higher or lower setting to achieve the user's desired output. This feature uses the controller's output percent along with the thresholds set by the user to determine the indication. These indications can be mapped to the dry contact relays, read on the user display, or read digitally via the warning alarm monitor parameter.

7.8.1 Setting Using Control Panel Software

To enable Tap Change indication set the High/Low Out % Alarm Display Text (XP 3410) selection on the System Tab. To set the High/Low thresholds, set parameters Tap Change Up Threshold (XP 3402) and Tap Change Down Threshold (XP 3403) on the Zone 1 Tab.

When enabling the Tap Change indicator there are a few visual changes to the Control Panel:

1. Warning alarms in the Dashboard section: Out% High/Low change to Tap Change Up/Down.
2. Zone 1 Tab: Output High/Low Alarm Threshold change to Tap Change Up/Down Threshold.
3. Zone 1 Tab: SP016 Relay 1 Alarm, Output% High/Low change to Tap Change Up/Down.

8. I/O

8.1 Alarm Relay [SP16, SP85]

	SX	HX
Relay Alarm Mask (SP16)	optional	optional
System Relay Mask (SP85)	optional	optional

The Relay is only available if the I/O section of the model number contains a "1", "3," "5", or "7."

There is one relay available on the MicroFusion controller. Both the Relay Alarm Mask (SP16) and the System Relay Mask (SP85) map to the same relay. All alarms mapped to the relay are OR'ed together.

The Relay Alarm Mask maps any or all of the following:

- Heatsink Over Temperature
- Over Current Trip
- Heatsink High Temperature Warning
- AC Line Phase Loss
- Shorted SCR
- Power Limit
- Current Limit
- Voltage Limit
- Deviation Alarm
- Output % High/Tap Change Up
- Output % Low/Tap Change Down
- Digital Run Enable (Run State request)
- 3 Phase Load Imbalance
- Low Output

The System Relay Alarm Mask maps any or all of the following:

- Run Enable (Switch terminals closed)
- Controller is in Run State
- Phase Lock Loop – Lock Loss
- Watchdog Timeout
- Memory Error
- Communication Error
- Processor Error Trap

Rating for the Relay are as follows:

Maximum switching Voltage	220 Vdc
	250 Vac
Maximum switching Current	2 A
Maximum switching capacity	60 W, 62.5 VA
UL contact ratings	220 Vdc / 0.24 A - 60 W
	125 Vdc / 0.24 A - 30 W
	250 Vac / 0.25 A - 62.5 VA
	125 Vac / 0.50 A - 62.5 VA
	30 Vdc / 2 A - 60 W

8.2 Isolated I/O (Optional)

The Isolated I/O provides 500 VAC of isolation to the Analog Inputs, General Purpose Input, Run/Stop, and the Retransmits. The option is only available when ordering from the factory and is not field upgradable.

8.3 General Purpose Input

	SX	HX
Pin 10 functionality of P1 connector	optional	optional

The General Purpose Input is only available if the I/O section of the model number contains a “2”, “3”, “6”, or “7.”

The General Purpose Input uses pins 8 and 10 of the P1 connector. When using this feature the General Purpose Input Function (SP133) must be defined. When pin 10 is pulled low (connected to pin 8) the controller will toggle the function defined in the General Purpose Input Function parameter.

8.4 General Purpose Input Function [SP133]

Opening and closing the connection between pin 8 & pin 10 of the P1 connector toggles:

[SP133] Function	Selections	See this parameter for reference
Control Setpoint Select	Setpoint 1 Source (Open) Setpoint 2 Source (Closed)	Control Setpoint Select (SP104)
Open/Closed Loop	Open Loop (Open) Closed Loop (Closed)	Control Mode (SP3)

Other selections may be available. Contact factory for special requests.

8.5 Pulse Width Modulation Input

A pulse width modulation signal may be used as a setpoint. The signal must be connected to Analog SP1 to function. The setpoint source [SP102] or [SP103] must also be set to PWM input.

Input Range:

20 Hz ≤ Frequency ≤ 2 kHz

0 - 5 Vdc maximum

8.6 Retransmits

	SX	HX
Retransmit 1	N/A	optional
Retransmit 2	N/A	optional

The Retransmits are only available if the Retransmits section of the model number contains an “R”.

The Retransmits are configured similarly to the analog inputs. The two Retransmits can be configured independently as either a current source (0 – 20 mA) or as a voltage source (0 – 10 Vdc). The Retransmits may be mapped to Load Voltage, Current or Power. It can also be set to a direct out signal.

9. CCI LINK™

This is a proprietary deterministic digital bus that enables multiple Control Concepts devices to communicate with each other.



9.1 Network LED Indicators

The CCI Link™ connector has 4 LEDs, 2 yellow and 2 green. There is one LED in each corner of the connector. The Network LED indicators use the yellow and green LED located closest to the heatsink of the controller. The yellow LED opposite of the heatsink is not used. The green LED is used in the Auto Terminating Resistor Circuit.

Network State	Green	Yellow	Description
Non-existent	OFF	OFF	Initializing
On-Line Unallocated	Flashing	OFF	No Connections
On-Line Allocated	ON	OFF	OFF
Wait-4-who's there	OFF	Blink (5 second interval)	Not on the network, waiting
Identify	X	OFF-Flash-OFF	Response to identify request
Timeout	ON	ON	Connection timed out
Comm Fault	OFF	ON	Bus-OFF, DUP MAC failure

X = don't care, or same state as before is maintained

When the controller does not detect any other devices on the CCI Link™ network the green LED will be OFF and the yellow LED will flash every 5 seconds.

The yellow network LED is also used to identify a specific controller on the CCI Link™ network. When a controller is commanded to identify itself, the yellow network LED will flash 5 times.

9.2 Auto Terminating Resistor Circuit

When connecting multiple devices on the CCI Link™ network, a terminating resistor must be pulled in at each end of the network trunk line tree. With the Auto Terminating Resistor Circuit the device automatically determines if the resistor needs to be pulled in based on if it is connected to one or two devices. When the resistor is pulled in the green LED on the CCI Link™ connector furthest away from the heatsink will be illuminated.

9.3 SYNC-GUARD™

The SYNC-GUARD™ feature reduces the possibility of synchronous operation of two or more zero cross controllers. This feature does not alter the power applied to the load, but adjusts the time when power is applied in such a manner as to reduce the possibility of two or more controllers being ON and OFF in unison.

SYNC-GUARD™ is useful whenever there are two or more power controllers connected to the same power source with a zero-cross firing mode selected. The SYNC-GUARD™ feature can significantly reduce the peak current required from a source that is connected to multiple power controllers while all are zero cross firing.

Zero cross firing is an ON-OFF type of control where the desired voltage, current, or power is delivered to the load by varying the controller's ON-OFF duty cycle. With zero cross firing, when the controller's output is ON, full supply voltage and current are provided to the load.

Without SYNC-GUARD™, multiple zero cross firing controllers could potentially be ON and OFF all at the same time. This would require heavy current to be drawn from the source while the controllers are all ON and no current when they are all OFF. The SYNC-GUARD™ feature works to reduce the peak current draw required from the source over time by causing each controller to attempt to find a time to turn ON when fewer, or no other, controllers are firing.

Limitations

As stated before: the SYNC-GUARD™ feature works to reduce the peak current draw required from the source for multiple controllers over time. However, each controller cannot predict when another controller is going to fire. Therefore the probability of multiple controllers firing at the same time exists even when using the SYNC-GUARD™ feature. The probability of this happening is highest when many controllers transition into the RUN state, and therefore turn ON at the same time. It is recommended that no more than 10 controllers be linked together with SYNC-GUARD™ over CCI Link™.

The figures below show the total current as a function of time for three controllers, with, and without SYNC-GUARD™ and various load powers. To set up the SYNC-GUARD™ feature, see the Installation manual.

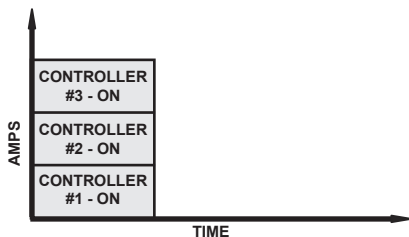

Three controllers providing 33.3% power each, operating synchronously without SYNC-GUARD™

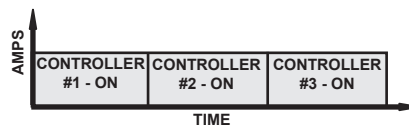

Three controllers providing 33.3% power each, with SYNC-GUARD™

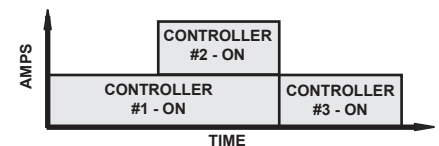

Three controllers with SYNC-GUARD™, two providing 33.3% power & one providing 66.6% power.

9.4 External Fieldbus Module

The external fieldbus module connects to other Control Concepts devices over the CCI Link™ bus. See Fieldbus Module in the Accessories Section of this manual for more details.

10. ACCESSORIES

10.1 CCI Link™ Cables

Available cable lengths:

- 6 inch cable – 0058003-0050-005
- 1 foot cable – 0058003-0050-01
- 5 foot cable – 0058003-0050-05
- 10 foot cable – 0058003-0050-10
- 15 foot cable – 0058003-0050-15

10.2 Fieldbus Module

The Fieldbus Module has any one of the following fieldbus interfaces: EtherCAT, EtherNet/IP, DeviceNet, Modbus RTU (RS-485), Modbus TCP, or PROFINET. Powered from the CCI Link™ bus, it can interface with up to 10 Control Concept devices. Each device must be given a unique MAC ID. All controllers can send or receive data over the CCI Link™ bus via one IP address.

From the fieldbus interface, configurations may be saved and loaded. Performance and data logging are available with the use of a Real Time Clock and Calander (RTCC). The Fieldbus Module also takes advantage of the Auto Termination Resistor Circuit.

Electrical Characteristics:

- 24 Vdc input power (via CCI Link™ bus)
- 100 mA maximum draw
- 3000 Vdc isolation

10.3 Remote Display

Easily view and customize limits, setpoints, and alarm conditions
2-Line, 16-character text display (Figure 1)
UL-type 1 & 12 ratings, IP65

See Appendix C for Remote Display setup and operation instructions



Figure 1

10.4 Din Rail Power Supplies

Ratings: 85-264 Vac input, +24 Vdc output

- 24 Watt – 0091011-0024-1
- 60 Watt – 0091011-0060-1
- 96 Watt – 0091011-0096-1

10.5 USB Cable

- 15 foot, A to Micro B – 0058006-0000-15

APPENDIX A: SPECIFICATIONS

PERFORMANCE		
	Standard	High Performance Option
Setpoint Resolution	10,000 counts	Selectable 10,000 or 64,000 counts
Internal Control Loop Resolution	16,000 counts	64,000 counts
Output Resolution	12,000 counts @ 50Hz, 10,000 counts @ 60Hz	50,000 counts @ 50Hz, 42k,000 counts @ 60Hz
Accuracy (Full Conduction)		
Voltage	3% of span	0.5% of span
Current	3% of span	0.5% of span
Power	3% of span	1% of span
Output Linearity	4% from 5 to 100% output range	1% from 5 to 100% output range
Accuracy	A +10% to -15% line voltage change will result in a max output change of 0.5% from 5 to 100% output range	A +10% to -15% line voltage change will result in a max output change of 0.05% from 5 to 100% output range
Temperature Drift	Output shall not change greater than 0.5% per degree C max over the operating temperature range from 5 to 100% output range	Output shall not change greater than 0.2% per degree C max over the operating temperature range from 5 to 100% output range

POWER	
Line Voltage (Auto Ranging)	24 - 600 Vac (Nominal) +10% / -15% (Contact factory for other options)
Line Frequency (Auto Ranging)	45 - 65 Hz
Frame Current Ratings (Amps)	I Continuous RMS (AC) 8 16 32 50 80
Current Rating- Peak Surge	20X frame rating
Minimum Hold/Latch Current	500 mA
SCR Rating (PIV)	1600 V peak forward & reverse
Fusing	Optional external Class T, branch-rated, touch-safe fusing
Thermal	Integrated heat sink thermal sensor
Current Limit	20% – 105% of continuous rating of Frame Amp Rating
Current Trip	50% - 450% of continuous rating
Power Dissipation	1.3 Watt per amp of load current per phase
Control Power / Operates Internal Control Electronics	24 Vdc +10 / -15%

ENVIRONMENTAL	
Surrounding Air Operating Temperature	32°F [0°C] - 122°F [50°C] with no derating 32°F [0°C] - 140°F [60°C] with current derating 140°F [60°C] 16A Frame = 16A Max Output 140°F [60°C] 32A Frame = 25A Max Output 140°F [60°C] 50A Frame = 40A Max Output 140°F [60°C] 80A Frame = 60A Max Output
Humidity	20% to 90% RH Non-Condensing
Rated Operating Altitude	Up to 6000 ft [1750m] at full rated current
Contaminates	ROHS Compliant, CE Pollution Degree 2
Storage Temperature	- 4 to 176°F [- 20 to 80°C]

DC POWER CONSUMPTION

8 - 50 Amp Single Phase	9 Watts
80 Amp Single Phase	11 Watts
16 - 80 Amp Three Phase	24 Watts

ENCLOSURE PROTECTIVE RATING

International	IP 20
Remote Display	IP 65, UL Type 1 & 12

RELIABILITY

Mean Time Between Failure (MTBF)	Designed for 50,000 Hours
----------------------------------	---------------------------

SCCR

Frame 1 Ø or 3 Ø	Recommended Fusing	SCCR Rating
8 (1 Ø only)	10 Fast Acting J or T	100 kA
16	20 Fast Acting J or T	100 kA
32	40 Fast Acting J or T	100 kA
50	60 Fast Acting J or T	100 kA
80	100 Fast Acting J or T	100 kA

COOLING

1Ø - 8 -50 Amp	Natural Convection
1Ø - 80 Amp	Forced Air with 1 fan PN 1608VL-05W-B60
3Ø - Din Rail	Forced Air with 1 fan PN 3100KL-05W-B60
3Ø - Liquid Cooled	Flow rate: 1 GPM [3.79 LPM] Maximum inlet temperature: 122° F [30° C] Maximum pressure: 60 PSI [4.137 Bar]
3Ø - External Panel Mount	Natural convection

ISOLATION

Signal to Line/Load	3750 Vac minimum
Line/Load to Ground	2500 Vac minimum
Signal to Ground	1500 Vac minimum
Line to Load	1400 Vac minimum
Network	1500 Vac minimum
USB	2500 Vac minimum
Signal to Processor	1500 Vac minimum
Remote Display	2500 Vac minimum

All controllers have 100kA when using less than or equal to 100 Amp class J or T fuses. Installed in enclosure with two latches, 150% of controller size.

Control Concepts recommends sizing fuses approximately 125% frame rating.

APPENDIX B: DIGITAL FIELDBUS

TO BE
DETERMINED

APPENDIX C: REMOTE DISPLAY

After applying universal input power, the user can now edit parameters via the display or the MicroFUSION Control Panel Software.

Auto Scroll

The 5 button display has an auto scroll and manual scroll display list.

Pictured right are examples of how screens will appear.

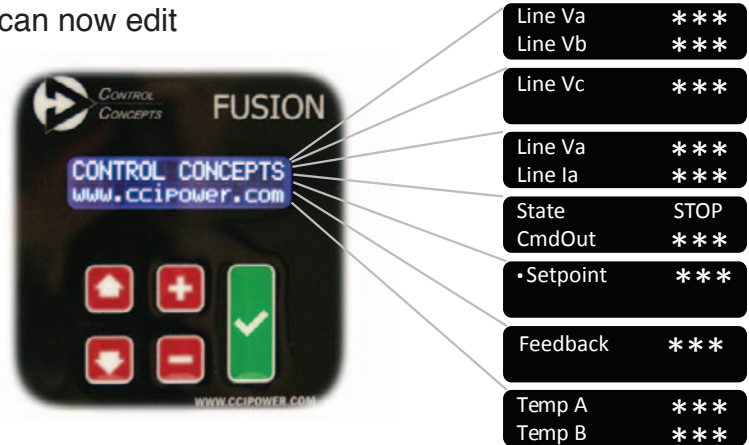

Manual Scroll

The controller will automatically start in auto scroll mode. The screen will change every few seconds. Press the arrow keys to access the manual scroll display list.



The up and down buttons will also scroll through different screens. To return to auto scroll, press and hold either button for a minimum of two seconds. If the display idles for ten minutes in manual scroll, it will automatically return to auto scroll.



Changing Value

On setable parameters there will be a dot in front of the parameter name. To adjust the value, press the green button. The dot will change to an arrow. See examples, right.



Press the Plus and Minus buttons to adjust the value up or down. After the desired value is reached, press the green button to accept the changes. The screen should appear as before with the adjusted value.

•Current Limit	140.0
→Current Limit	140.0
•Current Limit	1000



Note: If the parameter entry is left unchanged, or the accept button is not pressed, within 20 seconds the parameter will abort and return to the original value.

Screen Lists

Each controller is shipped with a customizable screen list that pertains to the hardware configuration of the controller. The default lists will show things such as line/load voltages, load currents and heatsink temperatures. If the controller is equipped with a communications card the default list will also show specific parameters pertaining to the communications settings.

The screen list can be customized by connecting to the MicroFUSION Control Panel software. Within the software any combination of screens can be programmed onto the screen (limit 50 screens).

Parameter Lock

A parameter lock can be setup to prevent anyone from changing parameter values using the display keypad. See direction on how to set this up in the Display Control section of the MicroFUSION Control Panel software manual.

APPENDIX D: FUSING OPTIONS

All touchsafe kits have 600 VAC, Branch-Rated, Class T Fusing

Single phase controllers require 2 Pole Fuseblocks, while Three Phase controllers require 3 Pole Fuseblocks.

Touchsafe Kits: Single Phase

MODEL NUMBER	CCI PART NUMBER	AMP SIZE	DESCRIPTION
F010	SFKTS62T10	10	2 Pole Assy - 2 x Fuse, 1 x Block, 2 x Cover
F015	SFKTS62T15	15	2 Pole Assy - 2 x Fuse, 1 x Block, 2 x Cover
F020	SFKTS62T20	20	2 Pole Assy - 2 x Fuse, 1 x Block, 2 x Cover
F025	SFKTS62T25	25	2 Pole Assy - 2 x Fuse, 1 x Block, 2 x Cover
F030	SFKTS62T30	30	2 Pole Assy - 2 x Fuse, 1 x Block, 2 x Cover
F035	SFKTS62T35	35	2 Pole Assy - 2 x Fuse, 1 x Block, 2 x Cover
F040	SFKTS62T40	40	2 Pole Assy - 2 x Fuse, 1 x Block, 2 x Cover
F045	SFKTS62T45	45	2 Pole Assy - 2 x Fuse, 1 x Block, 2 x Cover
F050	SFKTS62T50	50	2 Pole Assy - 2 x Fuse, 1 x Block, 2 x Cover
F060	SFKTS62T60	60	2 Pole Assy - 2 x Fuse, 1 x Block, 2 x Cover
F070	SFKTS61T70	70	1 Pole Assy - 1 x Fuse, 1 x Block, 1 x Cover (2 required)
F080	SFKTS61T80	80	1 Pole Assy - 1 x Fuse, 1 x Block, 1 x Cover (2 required)
F090	SFKTS61T90	90	1 Pole Assy - 1 x Fuse, 1 x Block, 1 x Cover (2 required)
F100	SFKTS61T100	100	1 Pole Assy - 1 x Fuse, 1 x Block, 1 x Cover (2 required)

Touchsafe Kits: Three Phase

MODEL NUMBER	CCI PART NUMBER	AMP SIZE	DESCRIPTION
F010	SFKTS63T10	10	3 Pole Assy - 3 x Fuse, 1 x Block, 3 x Cover
F015	SFKTS63T15	15	3 Pole Assy - 3 x Fuse, 1 x Block, 3 x Cover
F020	SFKTS63T20	20	3 Pole Assy - 3 x Fuse, 1 x Block, 3 x Cover
F025	SFKTS63T25	25	3 Pole Assy - 3 x Fuse, 1 x Block, 3 x Cover
F030	SFKTS63T30	30	3 Pole Assy - 3 x Fuse, 1 x Block, 3 x Cover
F035	SFKTS63T35	35	3 Pole Assy - 3 x Fuse, 1 x Block, 3 x Cover
F040	SFKTS63T40	40	3 Pole Assy - 3 x Fuse, 1 x Block, 3 x Cover
F045	SFKTS63T45	45	3 Pole Assy - 3 x Fuse, 1 x Block, 3 x Cover
F050	SFKTS63T50	50	3 Pole Assy - 3 x Fuse, 1 x Block, 3 x Cover
F060	SFKTS63T60	60	3 Pole Assy - 3 x Fuse, 1 x Block, 3 x Cover
F070	SFKTS63T70	70	3 Pole Assy - 3 x Fuse, 1 x Block, 3 x Cover
F080	SFKTS63T80	80	3 Pole Assy - 3 x Fuse, 1 x Block, 3 x Cover
F090	SFKTS63T90	90	3 Pole Assy - 3 x Fuse, 1 x Block, 3 x Cover
F100	SFKTS63T100	100	3 Pole Assy - 3 x Fuse, 1 x Block, 3 x Cover

APPENDIX E: 1Ø PART NUMBERS

uF1 - - -

Board Type

- SX = Standard
- HX = High performance

Terminal

- T = Pluggable terminal block
- R = Ring terminal¹

Frame Style

- A = 16 - 32A (Panel Mount / DIN Rail)
- B = 50 - 80A (Panel Mount / DIN Rail)
- E = 8A (Panel Mount / DIN Rail)

Option Board

- 0 = None
- I = EtherNet/IP
- E = Modbus TCP
- N = PROFINET

Amp Size

- 8 = 8 Amps²
- 16 = 16 Amps
- 32 = 32 Amps
- 50 = 50 Amps
- 80 = 80 Amps

Performance

Available with SX:

- S = Standard
- L = Adjustable Current Limit and current feedback

Available with HX:

- L = Adjustable Current Limit, current feedback, load voltage feedback, & voltage limit
- P = High Performance (Includes Load Voltage Feedback, True RMS Power Control, Current Limit, Power Limit, High Resolution Control Loop)

I/O

- 0 = None (Only applicable for SX; HX board is equipped with an alarm relay by default)
- 1 = Alarm Relay (1x Form C)
- 2 = General Purpose Input / Analog Input Channel 2 / Pulse Width Modulation Input
- 3 = Alarm Relay and General Purpose Input / Analog Input Channel 2 / Pulse Width Modulation
- 4 = Isolated I/O
- 5 = Isolated I/O with Alarm Relay
- 6 = Isolated I/O with Gen. Purpose Input / Analog Input Channel 2 / Pulse Width Modulation
- 7 = Isolated I/O with Alarm Relay and Gen. Purpose Input / Analog Input Channel 2 / Pulse Width Modulation

Retransmits

- 0 = None
- R = Retransmits² (Two 16-bit analog retransmits for voltage, current, or power)

Sync

- 0 = None
- S = Digital SYNC-GUARD™

Zero Cross Transformer Mode

- 0 = None
- Z = Zero Cross Transformer Mode²

Branch Rated Class T Fuse Options

- | | | | | |
|--------------|------------|------------|------------|-------------|
| Blank = None | F010 = 10A | F015 = 15A | F020 = 20A | F025 = 25A |
| F030 = 30A | F035 = 35A | F040 = 40A | F045 = 45A | F050 = 50A |
| F060 = 60A | F070 = 70A | F080 = 80A | F090 = 90A | F100 = 100A |

See "Fusing Options," page 7, for more information.

¹ Contact factory for availability
² Only available with HX type board

APPENDIX E: 3Ø PART NUMBERS

uF3 - -

Board Type

- SX = Standard
- HX = Upgradable High Performance

Load Configuration

- 4DY = Three Phase 4 SCR (2 Leg)
- 6DY = Three Phase Delta/Wye, 6 SCR
- 64Y = Three Phase 4 Wire Wye, 6 SCR
- 6ID = Three Phase Inside Delta, 6 SCR

Frame

- A = 16 - 32A (Panel Mount / Din Rail)
- B = 50 - 80A (Panel Mount / Din Rail)
- C = 16 - 32A (External Mount)
- D = 50A (External Mount)
- E = 16 - 32A (Liquid Cooled)
- F = 50 - 80A (Liquid Cooled)

Option Board

- 0 = None
- E = Modbus TCP
- I = EtherNet/IP
- N = PROFINET

Amp Size

- 16 = 16 Amps
- 32 = 32 Amps
- 50 = 50 Amps
- 80 = 80 Amps¹

Performance

- Available with SX:
 - S = Standard
 - L = Adjustable Current Limit and current feedback
- Available with HX:
 - L = Adjustable Current Limit, current feedback, load voltage feedback, & voltage limit
 - P = High Performance (Includes Load Voltage Feedback, True RMS Power Control, Current Limit, Power Limit, High Resolution Control Loop)

I/O

- 0 = None (Only applicable for SX; HX board is equipped with an alarm relay by default)
- 1 = Alarm Relay (1x Form C)
- 2 = General Purpose Input / Analog Input Channel 2 / Pulse Width Modulation Input
- 3 = Alarm Relay and General Purpose Input / Analog Input Channel 2 / Pulse Width Modulation
- 4 = Isolated I/O
- 5 = Isolated I/O with Alarm Relay
- 6 = Isolated I/O with Gen. Purpose Input / Analog Input Channel 2 / Pulse Width Modulation
- 7 = Isolated I/O with Alarm Relay and Gen. Purpose Input / Analog Input Channel 2 / Pulse Width Modulation

Retransmits

- 0 = None
- R = Retransmits² (Two 16-bit analog retransmits for voltage, current, or power)

Sync

- 0 = None
- S = Digital SYNC-GUARD™

Zero Cross Transformer Mode

- Z = Zero Cross Transformer Mode²

Branch Rated Class T Fuse Options

- | | | | | |
|--------------|------------|------------|------------|-------------|
| Blank = None | F010 = 10A | F015 = 15A | F020 = 20A | F025 = 25A |
| F030 = 30A | F035 = 35A | F040 = 40A | F045 = 45A | F050 = 50A |
| F060 = 60A | F070 = 70A | F080 = 80A | F090 = 90A | F100 = 100A |

See "Fusing Options," page 7, for more information.

¹ 80 Amps not available for external panel mount
² Only available with HX type board