KODAK Mini Video Camera



Extended user guide

Model Zm1

www.kodak.com

For interactive tutorials:

www.kodak.com/go/howto

For help with your camera:

www.kodak.com/go/support

Kodak

Eastman Kodak Company
Rochester, New York 14650
© Kodak, 2010

All screen images are simulated.

Kodak is a trademark of Eastman Kodak Company.

MICROSD and MICROSDHC are trademarks of the SD Card Association.

4H7179_en

Front view, Bottom view

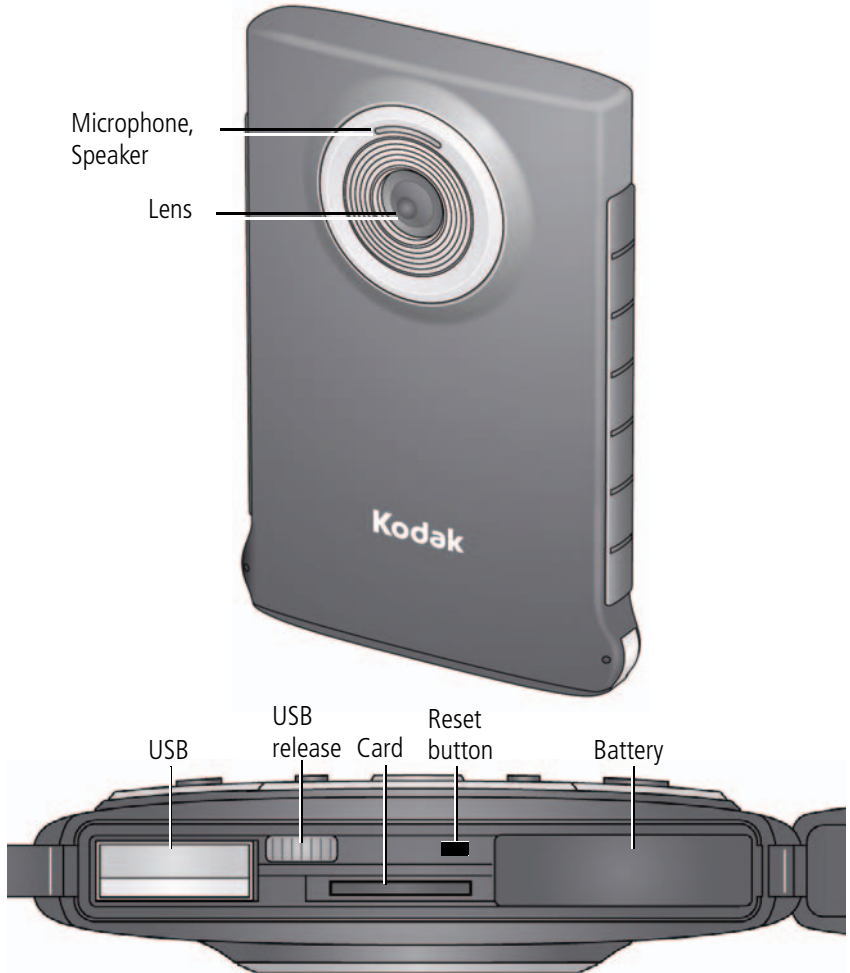

Back view, Closing the door

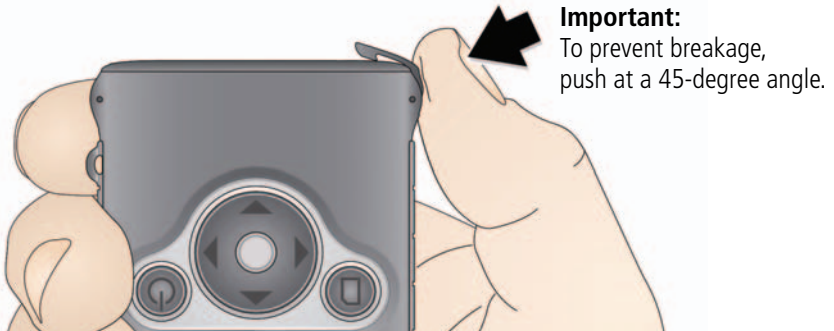
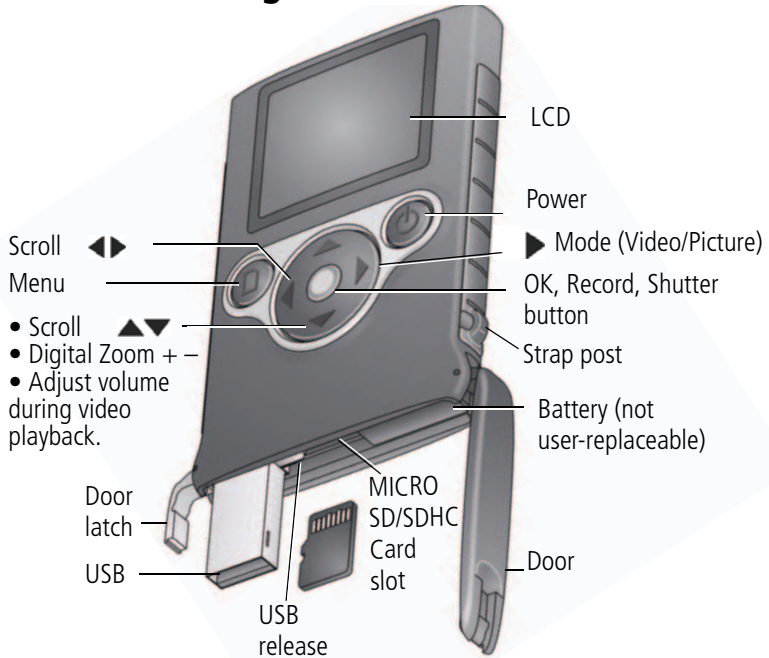

Understanding the status icons

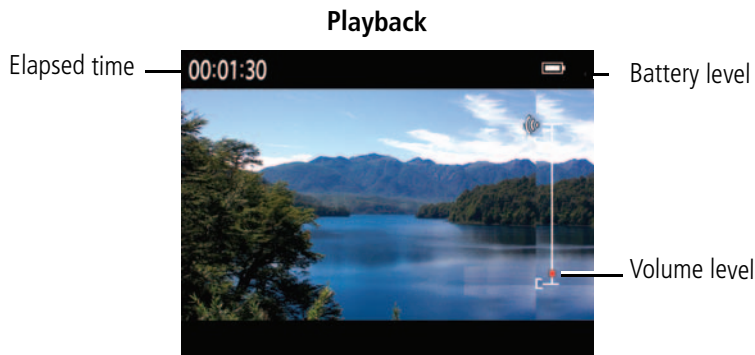
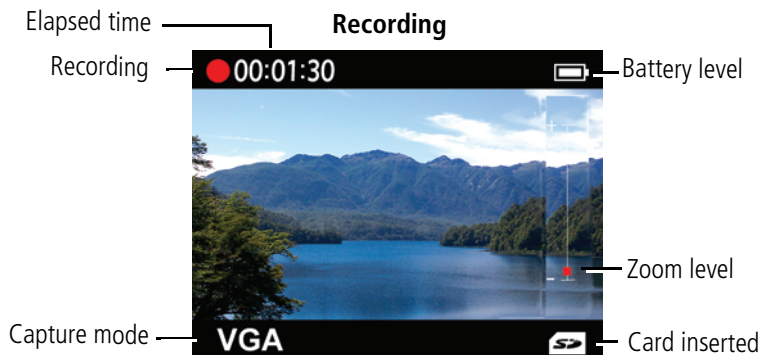

Table of contents

1	Setting up your camera	1
	Charging the battery (approximately 1 hour).....	1
	Inserting a MICROSD or MICROSDHC Card.....	2
	Connecting the strap.....	3
	Turning on the camera	4
	Setting the language, date/time.....	4
2	Using your camera	5
	Taking videos and pictures	5
	Reviewing, deleting pictures and videos.....	6
	Changing settings	7
	Transferring, editing, sharing online.....	8
3	Getting help	9
	Troubleshooting	9
	Getting help on the Web	11
4	Appendix	12
	Specifications	12
	Safety	13
	Care and maintenance	14
	Limited warranty	14
	Regulatory compliance	16

1

Setting up your camera

Charging the battery (approximately 1-2 hours)

Charge the Li-Ion battery whenever necessary. Turn off the camera, first.

IMPORTANT: *Make sure the computer is not in sleep, standby, or hibernate mode.*

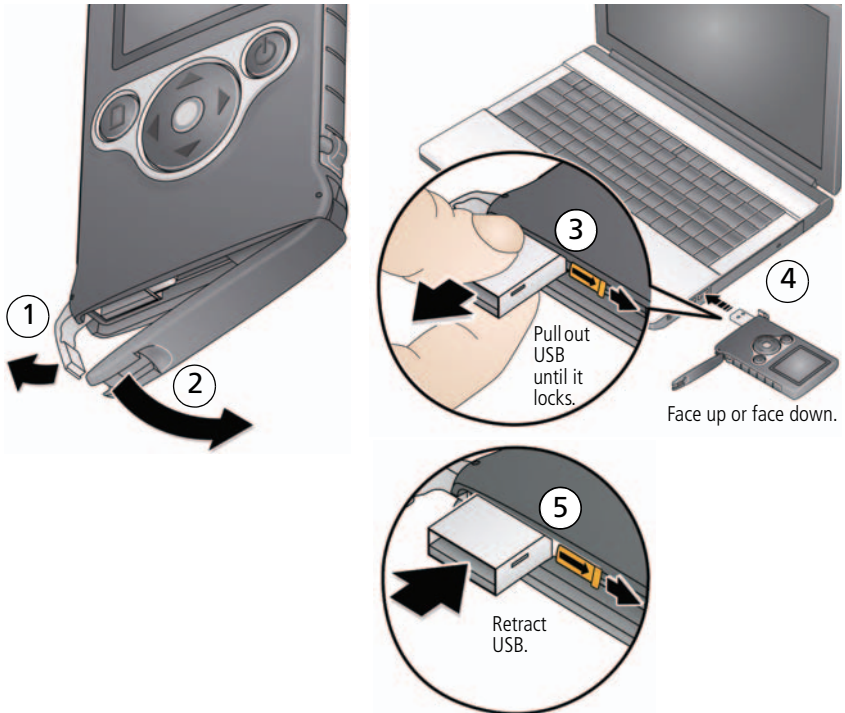

Close the door properly

[See page ii](#)

Check battery level

See the battery icon on the LCD

Inserting a MICROSD or MICROSDHC Card

Your camera has limited internal memory—good for a few practice videos/pictures. Check your product packaging to see if a MICROSD or MICROSDHC Card is included. If not, **we strongly suggest that you purchase a card.** (If a card is included, it may already be inserted.) Maximum supported card size is 16 GB.



CAUTION:

A card can only be inserted one way; forcing it may cause damage. Inserting or removing a card while the camera is on may damage the video/pictures, the card, or the camera.

- 1 Turn off the camera.
- 2 Insert the card until it clicks and locks into place.

To remove the card, push and release it, then pull it out.

NOTE: Avoid touching the card's metal contacts.

To clean the contacts, use a dry cotton swab or a lint-free cloth.

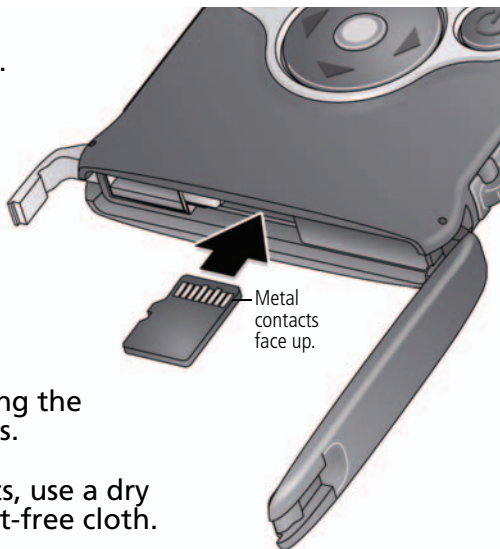

Close the door properly

[See page ii](#)

Purchase accessories

www.kodak.com/go/Zm1accessories

Connecting the strap

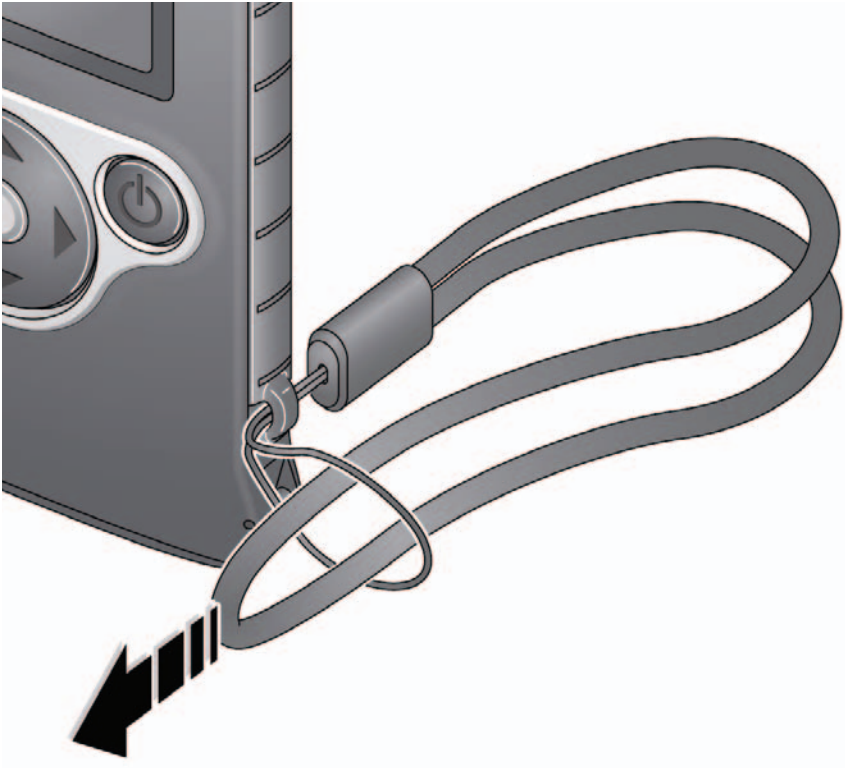

Turning on the camera



Setting the language, date/time

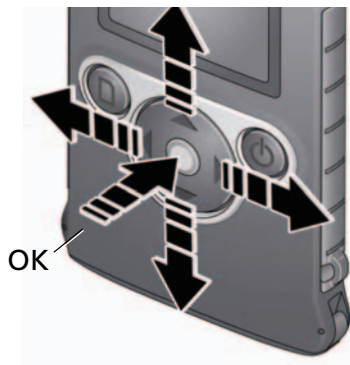

Language:

▲▼ to change.

OK to accept.

Date/Time:

At the prompt, press OK.

▲▼ to change current field.

◀▶ for previous/next field.

OK to accept.

Change date/time later [see page 7](#)

2

Using your camera

Taking videos and pictures

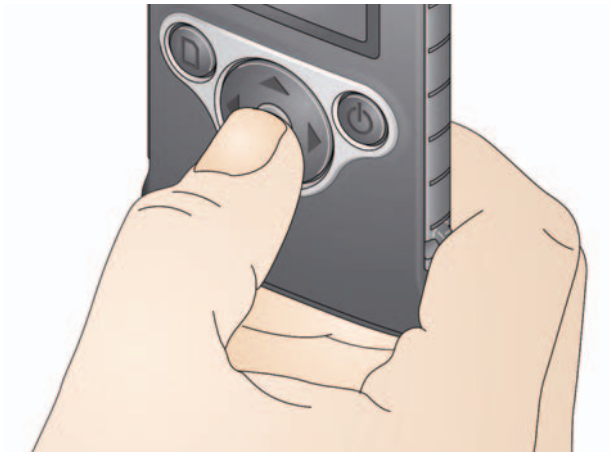

Take
videos

Press the OK button to start/stop recording.
(Press ► to choose a different recording mode.)

Take
pictures

- 1 Press ◀▶ to choose Picture .
 - 2 Press the OK button to take a picture.
-







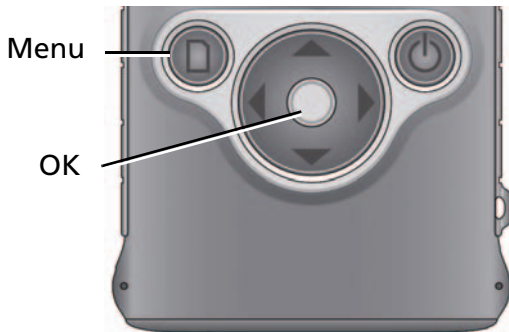





Digitally
zoom

Press ▲▼ to zoom in and out.









Reviewing, deleting pictures and videos



Review pictures, videos







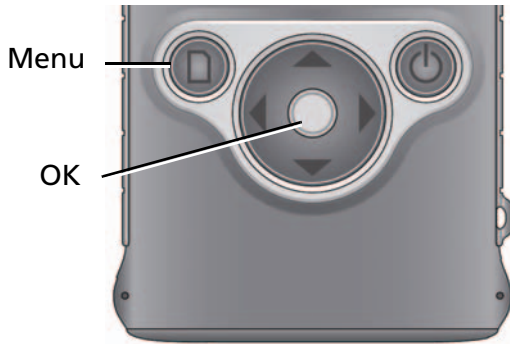

- 1 Press the Menu button .
- 2 Press   to highlight Review , then press OK.
 - Press   to scroll through pictures/videos.
 - Press OK to play a video or zoom a picture.
 - Press   to adjust volume during replay.
 - Press     to navigate a zoomed picture.Press Menu to return to recording mode.

Delete pictures, videos

- 1 Press the Menu button .
 - 2 Press   to highlight Review , then press OK. Press   to scroll through pictures/videos.
 - 3 Press   to highlight Delete , then press OK. Follow the prompts to delete the picture/video. Press Menu to return to recording mode.
-

Changing settings



- Change settings
- ① Press the Menu button .
 - ② Press     to highlight a setting, then press OK.
 - ③ Press     to change a setting, then press OK. Press Menu to return to recording mode.

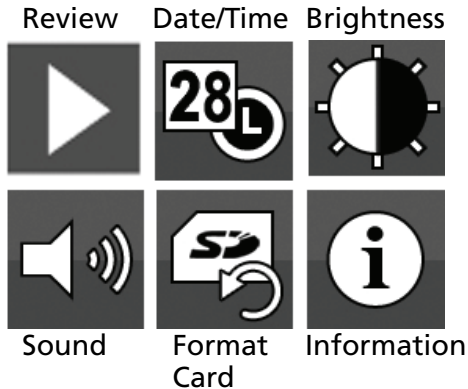

Transferring, editing, sharing online

- 1 Turn on the camera, then connect it.

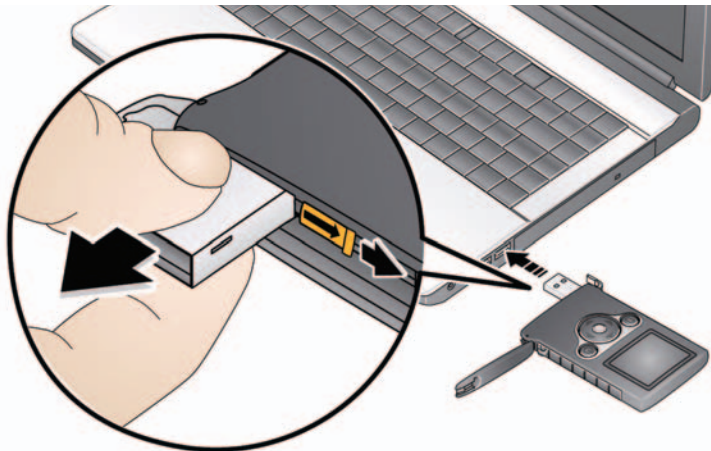

Slide the USB release to the right.

Pull the USB out until it locks.

Slide the USB release to the right to retract the USB.

- 2 If this is the first time you've connected to this WINDOWS OS-based computer, you're prompted to install ARCSOFT MEDIAIMPRESSION SE for KODAK Software. You can then transfer and share videos and pictures.

MAC OS—Videos and pictures can be used with the APPLE iLIFE suite of products.

WINDOWS VISTA/XP—Follow the prompts.

WINDOWS 7—Choose Open Folder To View Files.

Launch MI.exe, then click Yes on the User Account Control window.

Close the door properly







[See page ii](#)

Get ArcSoft product support

www.arcsoft.com/support

3 Getting help

Troubleshooting

Icon	Solution
	■ Low battery. Charge the battery.
	■ Corrupt or unusable file(s). Transfer videos/pictures to your computer, then format the card or internal memory.
	■ Internal memory is full. Transfer videos/pictures to your computer, or use a MICROSD/SDHC Card to take more videos/pictures.
	■ Card is full. Transfer videos/pictures to your computer or use another card.
	■ Unrecognized file. Transfer videos/pictures to your computer.
	■ An error has occurred. Transfer videos/pictures to your computer, then format the card.

Problem	Solution
Camera will not turn on.	<ul style="list-style-type: none">■ Ensure that the battery is charged.■ Ensure the camera is clean and dry. (If it's wet inside, let it dry for 24 hours.)
Videos are choppy or jumpy when played on a computer.	<ul style="list-style-type: none">■ Use ARCSOFT MEDIAIMPRESSION SE for KODAK Software for video playback (see page 8).■ Ensure that the computer system requirements are met. Go to www.arcsoft.com/support.
Videos are blurry.	<ul style="list-style-type: none">■ Ensure that the lens is clean.■ Ensure that the subject is at least 1 m (3.3 ft) from the lens.
Problems with ARCSOFT MEDIAIMPRESSION SE for KODAK Software.	<ul style="list-style-type: none">■ Go to www.arcsoft.com/support. (For other applications, go to their support sites.)

NOTE: If problems persist, go to www.kodak.com/go/support and click Step-by-Step Solutions & Repair.

Getting help on the Web

Get support for your product (FAQs, troubleshooting information, etc.)	www.kodak.com/go/Zm1support
See step-by-step solutions and repair information	www.kodak.com/go/stepbystep
Purchase camera accessories	www.kodak.com/go/Zm1accessories
Download the latest camera firmware and software	www.kodak.com/go/Zm1downloads
See online demonstrations of your camera	www.kodak.com/go/howto
Register your camera	www.kodak.com/go/register
Chat, email, write, or phone Kodak (Chat not available in all languages.)	www.kodak.com/go/contact
Get information on ARCSOFT Software	www.arcsoft.com/support

Specifications

Image Sensor—1/5-inch CMOS

Lens—f/2.4; 35 mm equivalent: 40 mm

Zoom—3X digital

LCD—4.6 cm (1.8 in.); 61.4K pixels

Image Storage—128 MB internal memory (approximately 64 MB available for image storage. 1 MB equals one million bytes); optional MICROSD/SDHC Card  (The SD logo is a trademark of the SD Card Association.) Maximum supported size: 16 GB MICROSD/SDHC.

Focusing System—Fixed

Focus Range—50 cm (1.6 ft)—infinity

White Balance—Auto

Exposure—Auto

File Format—■ Video: .AVI Motion JPEG; 640 x 480 @ 30 fps and 320 x 240 @ 30 fps, 320 x 240 @ 60 fps

■ Audio: PCM, 8 KHz

■ Still: JPEG/EXIF V2.21; 307 KP (640 x 480)

Shutter Speed—Auto

Microphone—Mono

Speaker—Yes

I/O Interface—USB 2.0 (high speed)

Tripod Mount—No

Power—Internal, rechargeable Li-Ion battery; in-camera charging via USB connector

Battery life—Approximately 85 minutes in VGA video recording mode

Waterproof capability—Conforms to IEC60529 IPX8, up to 3 meters (9.8 ft)

Dust resistance—Conforms to IEC60529 IP6X

Size—9.5 x 85 x 56 mm (0.4 x 3.3 x 2.2 in.)

Weight—70 g (2.5 oz) with battery, card

Operating temperature—0–40° C (32–104° F); do not expose camera to higher temperatures.

Safety



CAUTION:

Do not disassemble this product; there are no user-serviceable parts inside. Refer servicing to qualified service personnel. KODAK AC Adapters and battery chargers are intended for indoor use only. The use of controls, adjustments, or procedures other than those specified herein may result in exposure to shock and/or electrical or mechanical hazards. If the LCD breaks, do not touch the glass or liquid. Contact Kodak customer support.

- The use of an accessory that is not recommended by Kodak may cause fire, electric shock, or injury. For approved accessories, go to www.kodak.com/go/Zm1accessories.
- Use only a USB-certified computer equipped with a current-limiting motherboard. Contact your computer manufacturer if you have questions.
- In the unlikely event that battery fluid leaks onto your skin, wash immediately with water and contact your local health provider. For additional health-related information, contact your local Kodak customer support.
- Go to www.kodak.com/go/reach for information about the presence of substances included on the candidate list according to article 59(1) of Regulation (EC) No. 1907/2006 (REACH).

www.kodak.com/go/support

- If using this product in an airplane, observe all instructions of the airline.
- For more information, go to www.kodak.com/go/batteries.

Care and maintenance

- Before inserting or removing a card, make sure your hands, the camera, and the card are completely dry.
- If water has entered the camera, remove the card. Allow all components to air-dry for at least 24 hours before using the camera.
- Wipe off dirt or sand from the door seals—debris could compromise the seal and cause a leak in water.
- Do not subject the camera to temperatures lower than 0 (32° F) or higher than 40° C (104° F) for an extended time—the integrity of the seals may be compromised. Wait until camera reaches operating temperatures before using.
- Blow gently on the lens or LCD to remove dust and dirt. Wipe gently with a soft, lint-free cloth or an untreated lens-cleaning tissue. Do not use cleaning solutions unless designed specifically for camera lenses. Do not allow chemicals, such as suntan lotion, to contact painted surfaces.
- Service agreements may be available in your country. Contact a dealer of KODAK Products for more information.
- For camera disposal or recycling information, contact your local authorities. In the US, go to the Electronics Industry Alliance Web site at www.eiae.org or Kodak at www.kodak.com/go/support.

Limited warranty

Kodak warrants its digital cameras and accessories (excluding batteries) to be free from malfunctions and defects in both materials and workmanship for the warranty period specified on your KODAK Product packaging. Retain the original dated sales receipt. Proof of purchase date is required with any request for warranty repair.

Limited warranty coverage

Warranty service is only available from within the country where the Products were originally purchased. You may be required to ship Products, at your expense, to the authorized service facility for the country where the Products were purchased. Kodak will repair or replace Products if they fail to function properly during the warranty period, subject to any conditions and/or limitations stated herein. Warranty service will include all labor as well as any necessary adjustments and/or replacement parts. If Kodak is unable to repair or replace a Product, Kodak will, at its option, refund the purchase price paid for the Product provided the Product has been returned to Kodak along with proof of the purchase price paid. Repair, replacement, or refund of the purchase price are the sole remedies under the warranty. If replacement parts are used in making repairs, those parts may be remanufactured, or may contain remanufactured materials. If it is necessary to replace the entire Product, it may be replaced with a remanufactured Product. Remanufactured Products, parts and materials are warranted for the remaining warranty term of the original Product, or 90 days after the date of repair or replacement, whichever is longer.

Limitations

This warranty does not cover circumstances beyond Kodak's control. This warranty does not apply when failure is due to shipping damage, accident, alteration, modification, unauthorized service, misuse, abuse, use with incompatible accessories or attachments (such as third party ink or ink tanks), failure to follow Kodak's operation, maintenance or repacking instructions, failure to use items supplied by Kodak (such as adapters and cables), or claims made after the duration of this warranty. Kodak makes no other express or implied warranty for this product. In the event that the exclusion of any implied warranty is ineffective under the law, the duration of the implied warranty will be the length of the express warranty period specified on your KODAK Product packaging. The option of repair, replacement, or refund is Kodak's only obligation. Kodak will not be responsible for any special, consequential or incidental damages resulting from the sale, purchase, or use of this product regardless of the cause. Liability for any special, consequential or incidental damages (including but not limited to loss of revenue or profit, downtime costs, loss of the use of the equipment, cost of substitute equipment, facilities or services, or

www.kodak.com/go/support

claims of your customers for such damages resulting from the purchase, use, or failure of the Product), regardless of cause or for breach of any written or implied warranty is expressly disclaimed. The limitations and exclusions of liability set forth herein apply to both Kodak and its suppliers.

Your rights

Some states or jurisdictions do not allow exclusion or limitation of incidental or consequential damages, so the above limitation or exclusion may not apply to you. Some states or jurisdictions do not allow limitations on how long an implied warranty lasts, so the above limitation may not apply to you. This warranty gives you specific rights, and you may have other rights which vary from state to state or by jurisdiction.

Outside the United States and Canada

In countries other than the United States and Canada, the terms and conditions of this warranty may be different. Unless a specific Kodak warranty is communicated to the purchaser in writing by a Kodak company, no warranty or liability exists beyond any minimum requirements imposed by law, even though defect, damage, or loss may be by negligence or other act.

Regulatory compliance

FCC compliance and advisory

This equipment has been tested and found to comply with the limits for a Class B digital device, pursuant to Part 15 of the FCC Rules. These limits are designed to provide reasonable protection against harmful interference in a residential installation. This equipment generates, uses, and can radiate radio frequency energy and, if not installed or used in accordance with the instructions, may cause harmful interference to radio communications. However, there is no guarantee that interference will not occur in a particular installation. If this equipment does cause harmful interference to radio or television reception, which can be determined by turning the equipment off and on, the user is encouraged to try to correct the interference by one or more of the following measures: 1) reorient or relocate the receiving antenna; 2) increase the separation between the equipment and the receiver; 3) connect the equipment to an outlet on a circuit different from that to

which the receiver is connected; 4) consult the dealer or an experienced radio/TV technician for additional suggestions. Any changes or modifications not expressly approved by the party responsible for compliance could void the user's authority to operate the equipment. Where shielded interface cables have been provided with the product or specified additional components or accessories elsewhere defined to be used with the installation of the product, they must be used in order to ensure compliance with FCC regulation. The KODAK High Performance USB AC Adapter K20-AM complies with part 15 of the FCC Rules. Operation is subject to the following two conditions: (1) This device may not cause harmful interference, and (2) this device must accept any interference received, including interference that may cause undesired operation.

CE

Hereby, Eastman Kodak Company declares that this KODAK Product is in compliance with the essential requirements and other relevant provisions of Directive 1999/5/EC.

Waste Electrical and Electronic Equipment labeling/battery disposal



In Europe: For human/environmental protection, it is your responsibility to dispose of this equipment and batteries at a collection facility established for this purpose (separate from municipal waste.) For more information, contact your retailer, collection facility, or appropriate local authorities; or go to www.kodak.com/go/recycle. Product weight: 70 g (2.5 oz) with battery, card.



Russian GOST-R



Eastman Kodak
Company

Фотокамера изготовлена в Китае; остальные элементы -
в соответствии с маркировкой.

China RoHS

环保使用期限 (EPUP)

在中国大陆，该值表示产品中存在的任何危险物质不得释放，以免危及人身健康、财产或环境的时间期限（以年计）。该值根据操作说明中所规定的产品正常使用而定。

有毒有害物质或元素名称及含量标识表						
部件名称	有毒有害物质或元素					
	铅	汞	镉	六价铬	多溴联苯	多溴二苯醚
数码相机电路板组件	x	○	○	○	○	○
锂电池	x	○	○	○	○	○

○：表示该有毒有害物质在该部件所有均质材料中的含量均在SJ/T 11363-2006规定的限量要求以下。
 ×：表示该有毒有害物质至少在该部件的某一均质材料中的含量超出SJ/T 11363-2006规定的限量要求。

Canadian DOC statement

DOC Class B Compliance—This Class B digital apparatus complies with Canadian ICES-003.

Observation des normes-Classe B—Cet appareil numérique de la classe B est conforme à la norme NMB-003 du Canada.

Australian C-Tick



Index

A

accessories, purchase, 11

B

battery charging, 1

button

reset, i

USB release, i

C

camera settings, 7

card, loading, 2

care and maintenance, 14

cautions, 14

changing settings, 7

charging battery, 1

clock, setting, 4

connecting the strap, 3

connecting to a computer, 8

D

date setting, 4

deleting pictures, videos, 6

digital zoom, 5

disposal, recycling, 14

E

erase pictures, videos, 6

H

help, Web links, troubleshooting, 9

I

icons, iii

installing software, 8

K

Kodak Web sites, 9

L

lens, cleaning, 14

loading, card, 2

M

maintenance, camera, 14

MICROD/SDHC card loading, 2

microphone, i

O

on/off, 4

P

pictures

deleting, 6

reviewing, 6

taking, 5

playing a video, 6

R

recycling, disposal, 14

release, USB, i

repair, 11

reset button, i

reviewing pictures, videos, 6

S

- setting date and time, 4
- setting up the camera, 1
- settings, camera, 7
- sharing online, 8
- software, installing, 8
- specifications, 12
- status icons, iii
- strap, 3

T

- taking pictures, videos, 5
- time and date, setting, 4
- tips, care, & maintenance, 14
- transferring videos, 8
- troubleshooting, 9
- turning on/off camera, 4

U

- URLs, Kodak Web sites, 9
- USB
 - connection, 8
 - release, i

V

- videos
 - deleting, 6
 - reviewing, 6
 - taking, 5

W

- warranty, 14

Z

- zoom, using, 5