



GST5000 Intelligent Fire Alarm Control Panel



**Installation and Operation Manual
(Generic Part)**

Issue 4.02 August 2007
ERP:30302791

CONTENTS

Chapter 1 Product Introduction	1
Chapter 2 Technical Specifications	2
2.1 Operating Voltage	2
2.2 Standby Batteries	2
2.3 Communication Loop Parameters	2
2.3.1 RS485 Communication Loop	2
2.3.2 RS232 Communication Loop	2
2.4 Detection Loop Parameters	2
2.5 Output Loop Parameters.....	3
2.6 Dimension	3
2.6.1 Wall-mounted GST5000W FACP	3
2.6.2 Rack type GST5000 FACP	4
2.6.3 Console type GST5000 control panel	5
Chapter 3 Structure and Configuration	7
3.1 Display and Operation Area	7
3.1.1 Indicators	7
3.1.2 Key Functions.....	8
3.2 Zone Indication and Manual Intervention Panel (ZCP)	8
3.2.1 Structure	9
3.2.2 Functions	9
3.3 Configuration.....	10
3.3.1 Typical Configuration.....	10
3.3.2 Optional Configuration.....	14
3.4 Field Devices.....	15
3.4.1 A Series of Intelligent Fire Detectors	15
3.4.2 Modules	15
3.4.3 Loop Isolator.....	15
3.4.4 Manual Call Point	15
3.4.5 Addressable Sounder Strobe	16
3.4.6 GST852RP Repeater Panel.....	16
3.5 C&E Equation and Device Definition Software.....	16
Chapter 4 Mounting	17
4.1 Configuration Inspection	17
4.1.1 Check Engineering Configuration	17
4.1.2 Check Internal Configurations and Interconnection of the FACP	17
4.2 Installation of the Cabinet	17
4.2.1 Installation condition and method of wall-mounted FACP	17
4.2.2 Installation condition and method of rack type and console-typed FACP.....	18
4.3 Start-up Check	18
4.4 Connections of Field Devices	19
4.4.1 Connection of Sounder Circuit Output	20

4.4.2 Connection of F.P.E. Output	21
4.4.3 Connection of Fire Alarm Output.....	21
4.4.4 Connection of Class A Loop	22
4.4.5 Connection of Communication Loop	22
4.4.6 Connection of Ring Module	23
4.5 Connection Inspection and Device Registration.....	23
4.5.1 Connection Inspection.....	23
4.5.2 Registration of Devices	23
4.6 Definition of Devices	24
4.6.1 Browsing Zone Definition	25
4.6.2 Browsing Device Information	26
4.6.3 Viewing C&E.....	28
4.7 Field Devices Commission.....	30
Chapter 5 Display and Disposal of System Information	31
5.1 Normal Information.....	31
5.2 Information of Fire Alarm.....	31
5.2.1 Fire Alarm Screen.....	31
5.2.2 Disposal of Fire Alarm Signal	34
5.3 Fault Information	34
5.3.1 Screen of Fault Information.....	34
5.3.2 Disposal of Fault Information	35
5.4 Disable and Enable	35
5.4.1 Use of Disable/Enable.....	35
5.4.2 Disable/Enable Devices	35
5.4.3 Browsing Disabled Information	37
5.5 Manual Start and Stop of Loop Devices	38
5.5.1 START/STOP Operation through Keypad.....	38
5.5.2 Operation of the Devices by ZCP.....	39
5.5.3 Browsing Started Devices	39
5.6 Resetting and Silencing of the System.....	40
5.7 Rules for Information Display.....	41
5.8 Rules for Sound Indication.....	41
Chapter 6 Description of System Operation.....	42
6.1 Keypad	42
6.1.1 Functions	42
6.1.2 Common Method of Data Input	42
6.1.3 Method of Browsing Information	42
6.1.4 Keypad Unlock and Lock.....	42
6.2 User Operation Instruction.....	43
6.2.1 Changing time display	43
6.2.2 Browsing history records.....	43
6.3 Instructions for System Operator	44
6.3.1 Self Test.....	44

6.3.2 Printer Setting.....	44
6.3.3 Security Mode.....	45
6.3.4 Extinguishing Mode	45
6.3.5 Modification of System Time	46
6.4 Instructions for System Administrator	47
6.4.1 Password Modification	47
6.4.2 Communication Setting	49
6.4.3 Working State Setup.....	49
6.4.4 Fire Display Mode	50
6.4.5 Zone Browse	50
6.4.6 C&E Equation Browse.....	50
6.4.7 Browsing supervisory data of addressable devices.....	51
Chapter 7 Commissioning Functions.....	52
7.1 Getting into Commission Mode.....	52
7.2 Exiting Commission Mode	53
7.3 Registration at Any Time	53
7.4 Loop Card Disablement	53
7.5 Detector Searching	53
7.6 Protection of C&E Equations	53
Chapter 8 Troubleshooting and Regular Checks.....	54
8.1 General Fault Treatment.....	54
8.2 Regular Checks and Replacement.....	55
Chapter 9 Calculation of Battery Capacity.....	59
Appendix 1 Internal Connection Diagram.....	60
Appendix 2 Device Type List	62
Appendix 3 Operation Menu.....	64

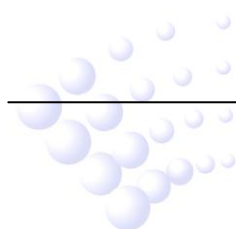

Preface

GST5000 Intelligent Fire Alarm Control Panel Installation and Operation Manual includes two parties: generic part and Fireman's Control Panel part. This is the generic part. Please refer to relative part for description on Fireman's Control Panel.

Please assign a specific person to keep this manual for occasional use during operation of the GST5000 Intelligent Fire Alarm Control Panel.

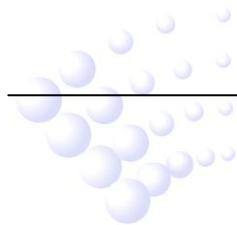

Chapter 1 Product Introduction

GST5000 Intelligent Fire Alarm Control Panel (FACP) is designed by EN 54-2 standard with qualities of simple installation, operation, and easy maintenance. It is used in fire alarm system with the following features:

- (1) It controls maximum 60 fire zones. Each zone has Alarm and FLT/Disable LEDs and a zone label separately. It's expandable to a maximum of 256 zones.
- (2) It provides 4 Class A loops as standard, which can be expanded to maximum 28 loops. Each loop can have up to 235 addressable devices. It is compatible with a series of addressable GST products, which are intelligent sounder strobe (I-9403) complying with EN 54-3, photoelectric smoke detector (I-9102) complying with EN 54-7, rate of rise and fixed temperature heat detector (I-9103) complying with EN 54-5, intelligent manual call point (I-9202) complying with EN 54-11, intelligent reflective beam detector (I-9105R) complying with EN 54-12, input and output module (I-9300, I-9301) complying with GEI 1-084, and loop isolator (C-9503) complying with GEI 1-052.
- (3) Graphic display can show 320x240 dot matrix, assisting the 15 LEDs to display important information.
- (4) The memory does not lose data even if power supply is accidentally removed.
- (5) It has manual keys for each zone, which can activate/mute the sounder strobe separately.
- (6) Automatically prompting operation steps for every alarm device and for smoke exhaust and fire extinguisher by field programming.
- (7) Sounder strobe interface provides 0.5A/24V output, compatible with GST conventional sounder strobe (C-9403) designed according to EN 54-3.
- (8) RS232 interface enables communication with PC.
- (9) RS485 interface enables networking.

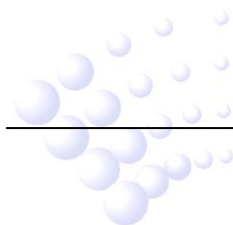

Chapter 2 Technical Specifications

2.1 Operating Voltage

- ✧ Input Voltage: 220/230VAC
- ✧ Frequency: 50/60Hz
- ✧ Input Current: 0.75A
- ✧ Fuse: 2A delay
- ✧ Recommended Wiring: 1.5mm² or above screened cable, complying with local installation codes.

2.2 Standby Batteries

- ✧ Maximum Charge Current: 27.2V@0.8A float charge
- ✧ Type: Sealed lead acid batteries
- ✧ Maximum Charge Capacity: 38 Ah
- ✧ Fuse: 8A
- ✧ Wiring: GST FireCable®2E/1.5 2core and Earth 1.5mm² CSA (subject to local installation codes).

2.3 Communication Loop Parameters

2.3.1 RS485 Communication Loop

- ✧ **NETWORK (A, B):** Communication cable for connecting with up to 32 network control panels of different model.
- ✧ **REPEATER (A, B):** Communication cable for connecting with up to 64 repeater panels.

Recommended Wiring: GST FireCable ® 2E/1.0 2core and Earth 1mm² CSA (subject to local installation codes).

2.3.2 RS232 Communication Loop

RS232 communication loop is connected with CRT system installed in PC through RJ45 plug connector.

Wiring: Cable length should be less than 15m.

2.4 Detection Loop Parameters

- ✧ LOOP OUT (+, -): Polarized signal bus from GST5000, connecting with 235 addressable devices at most.
- ✧ LOOP IN (+, -): Polarized signal bus returning to GST5000.
- ✧ Output Voltage: 24V pulse
- ✧ Output Current: 0.3A

Recommended Wiring: GST FireCable ® 2E/1.0 2core and Earth 1mm² CSA

2.5 Output Loop Parameters

Recommended Wiring: GST FireCable ® 2E/1.0 2core and Earth 1mm² CSA

(1) FIRE ALARM OUTPUT (+, -)

Output Voltage: 21VDC~27VDC

Output Current: 0.5A

Terminal Resistor: 4.7KΩ

(2) F.P.E OUTPUT (+, -)

Output Voltage: 21VDC~27VDC

Output Current: 0.5A

Terminal Resistor: 4.7KΩ

(3) SOUNDER CIRCUIT OUTPUT (+, -)

Output Voltage: 21VDC~27VDC

Output Current: 0.5A

Terminal Resistor: 4.7KΩ

(4) FAULT OUTPUT (NC, COM, NO)

Contact Capacity: 24VDC @1.0A

In fault state, NC and COM open, NO and COM close.

2.6 Dimension

2.6.1 Wall-mounted GST5000W FACP

Dimension (L × W × H): 500mm×170mm×700mm

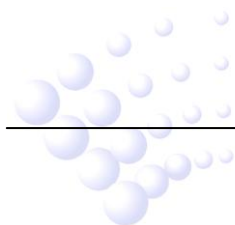

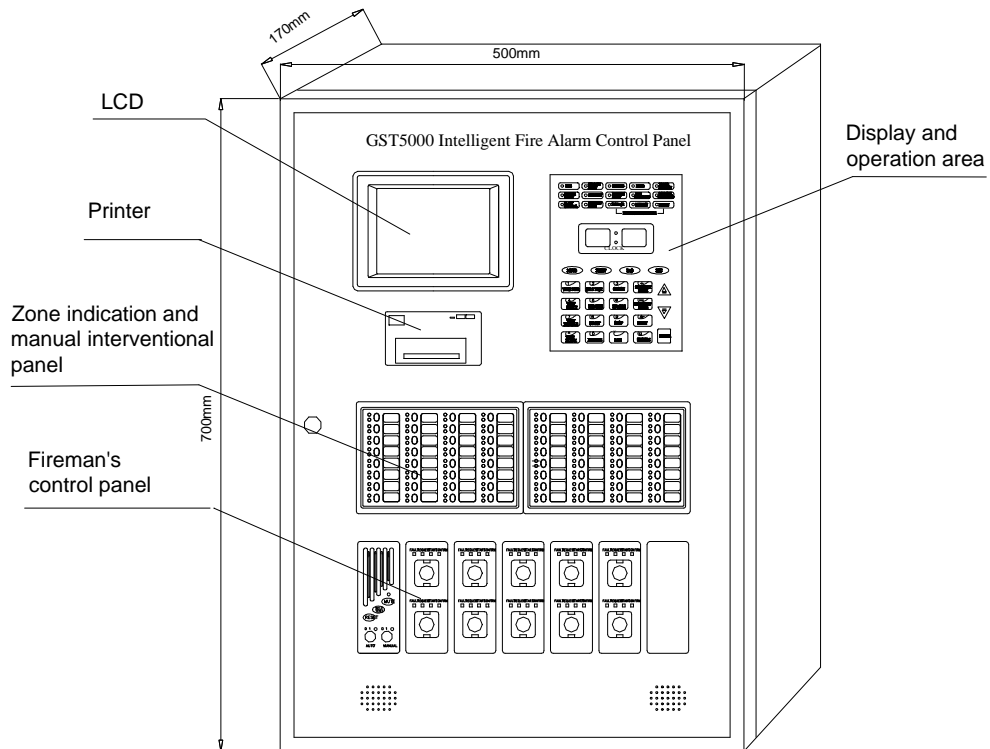
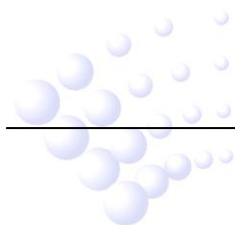

Fig. 2-1

2.6.2 Rack type GST5000 FACP

Dimension (L x W x H): 580mmx520mmx1715mm



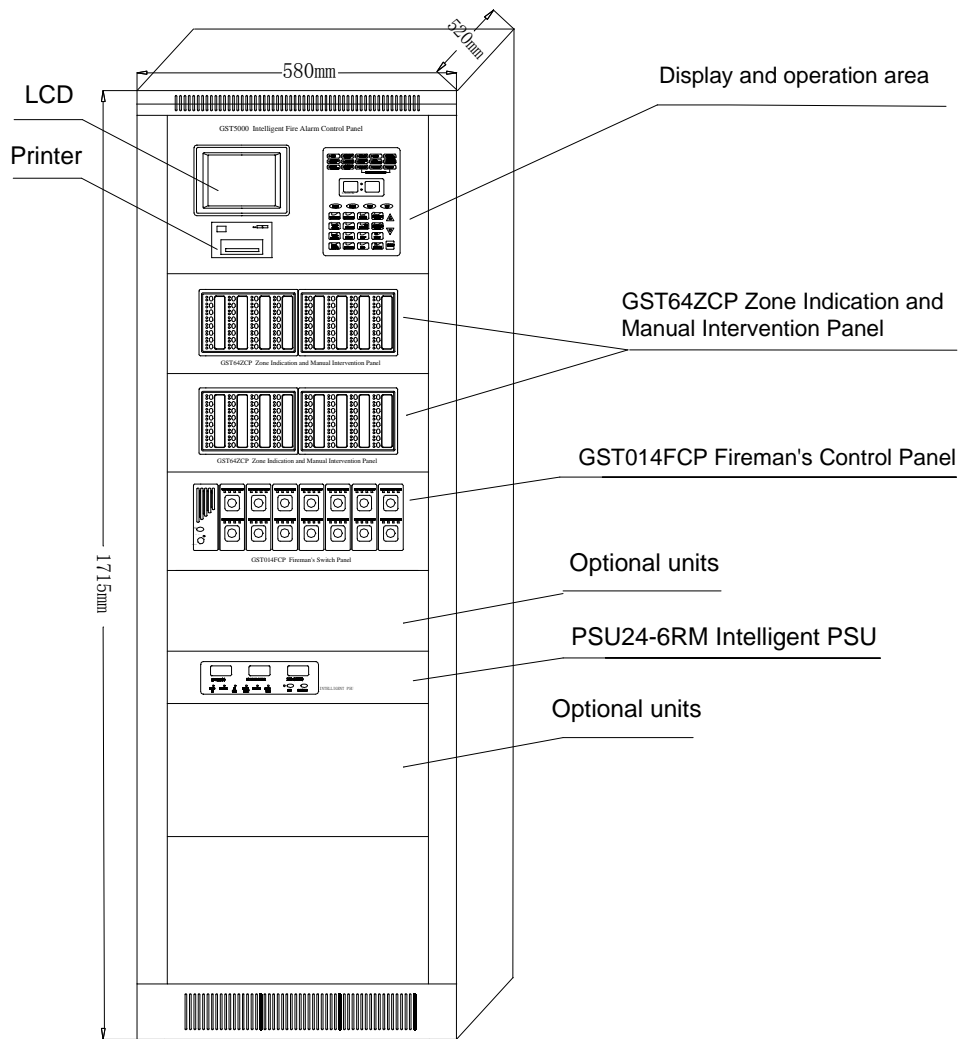
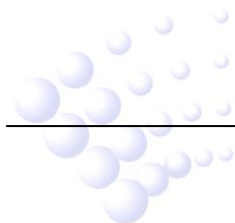

Fig. 2-2

2.6.3 Console type GST5000 control panel

Dimension (L x W x H, single unit) : 555mm x 933mm (with table) x 1350mm

Dimension (L x W x H, double unit): 1045mm x 933mm (with table) x 1350mm



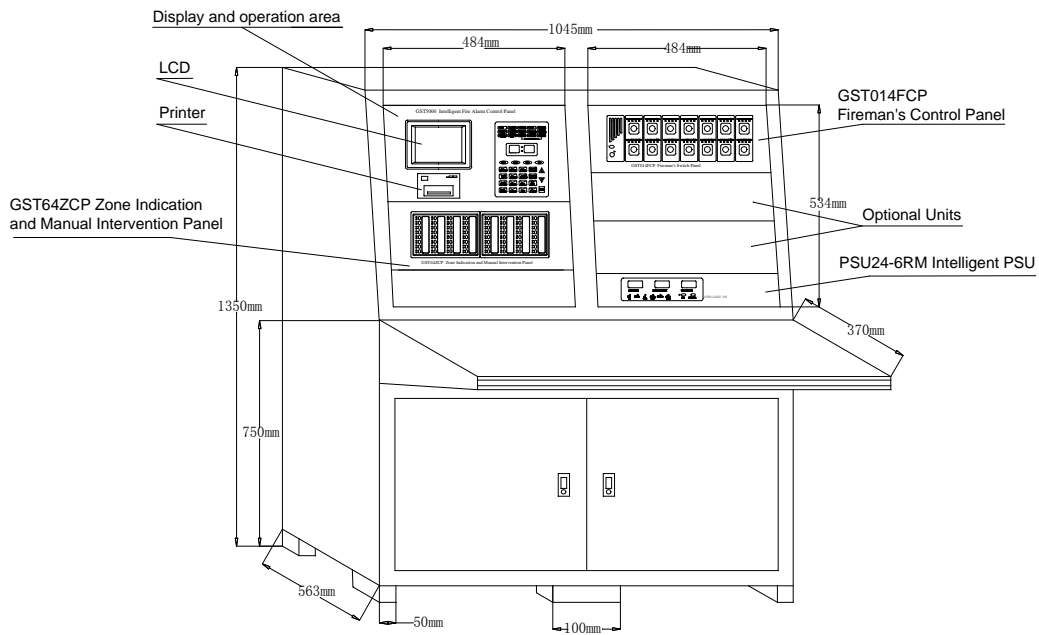
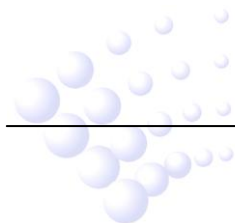

Fig. 2-3

Note: There are three types of GST5000 FACP: wall-mounted type, rack type and console type. In the following parts of this manual, differences between the three types will be elaborated separately and the similarities described together.



Chapter 3 Structure and Configuration

3.1 Display and Operation Area

The display and operation area is shown in Fig. 3-1, which consists of LCD display, indicators, clock display, keypad and printer.

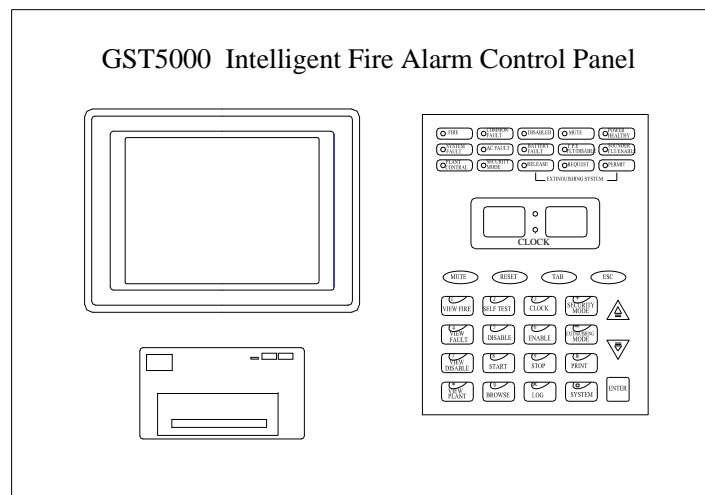

Fig. 3-1

3.1.1 Indicators

- ✧ FIRE: Red. This LED lit means the FACP has checked fire alarm state of connected detectors. Detailed messages are shown on the LCD. When fire alarm is cleared, press *RESET* key to turn it off.
- ✧ COMMON FAULT: Yellow. Lit when any fault occurs.
- ✧ DISABLED: Yellow. Lit when connected devices, F.P.E. output or SOUNDER output are disabled.
- ✧ MUTE: Yellow. When the FACP sounds alarm, pressing *MUTE* key, this LED illuminates, and the speaker stops alarming. If *MUTE* key is pressed again or there are new alarms, it goes out and the FACP sounds again.
- ✧ POWER HEALTHY: Green. It illuminates when mains or standby battery of the system works normally.
- ✧ SYSTEM FAULT: Yellow. Lit when the program fails or the system cannot operate normally.
- ✧ AC FAULT: Yellow. Lit when mains power is cut off or defected, and goes out when it resumes.
- ✧ BATTERY FAULT: Yellow. Lit when standby power system is in fault and goes out when it's cleared.
- ✧ F.P.E. FLT/DISABLE: Yellow. Lit when F.P.E. output is in fault or is disabled.

- ✧ SOUNDER FLT/DISABLE: Yellow. Lit when SOUNDER output is in fault or is disabled.
- ✧ PLANT CONTROL: Green. Action message indication. Lit when there are feedback signal inputs of fire-protective plant.
- ✧ SECURITY MODE: Green. Lit when there is delay message with the FACP.
- ✧ EXTINGUISHING SYSTEM RELEASE: Green. Lit when connected extinguishing system has been activated.
- ✧ EXTINGUISHING SYSTEM REQUEST: Green. Lit when extinguishing system is ready to be activated or in delay state.
- ✧ EXTINGUISHING SYSTEM PERMIT: Green. Lit when extinguishing system gets permission to be activated.

3.1.2 Key Functions

- ✧ MUTE: Silencing the panel.
- ✧ RESET: System reset.
- ✧ TAB: Transferring time display mode.
- ✧ ESC: Returning to the previous menu or normal operation screen.
- ✧ VIEW FIRE: Viewing fire alarm messages.
- ✧ VIEW FAULT: Viewing fault messages.
- ✧ VIEW DISABLE: Viewing disabled messages.
- ✧ VIEW PLANT: Viewing messages of started fire suppression devices in the system.
- ✧ SELF TEST: Self-testing the panel.
- ✧ DISABLE: Disabling a system device.
- ✧ ENABLE: Re-enabling a disabled device.
- ✧ CLOCK: Modifying system time.
- ✧ START: Starting fire suppression devices.
- ✧ STOP: Stopping fire suppression devices.
- ✧ PRINT: Setting printing mode.
- ✧ SECURITY MODE: Setting security mode.
- ✧ EXTINGUISHING MODE: Setting gas extinguishing mode.
- ✧ BROWSE: Viewing system configuration.
- ✧ LOG: Viewing history records.
- ✧ SYSTEM: System menu.
- ✧ ENTER: Confirming an operation.

- ✧ \triangle and ∇ : Page up and down.

3.2 Zone Indication and Manual Intervention Panel (ZCP)

The zone indication and manual intervention panels of the three types of GST5000 FACP have the same structure and function. The cabinet of wall-mounted GST5000W FACP can connect with only one GST64ZCP zone indication and manual intervention

panel. Rack type and console type can be expanded with more on order.

3.2.1 Structure

The ZCP includes two LED boards and one control board. Control board connects with the two LED boards through pins. Structure of the control board is shown in Fig. 3-2.

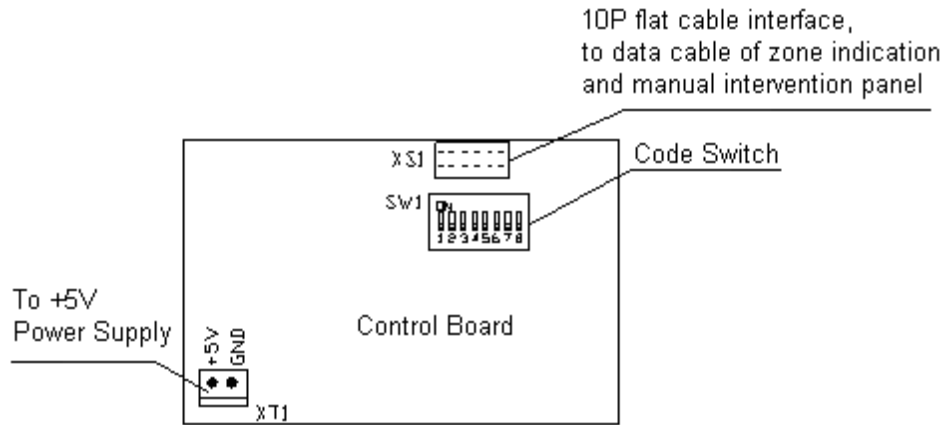

Fig. 3-2

Every loop card can drive 4 ZCPs. All of them are connected together with a 10p ribbon cable through XS1 of the control board.

We can use the switch to set a code for each ZCP.

- No. 1: 1, 6, 8 at ON, others at OFF.
- No. 2: 2, 6, 7 at ON, others at OFF.
- No. 3: 3, 5, 8 at ON, others at OFF.
- No. 4: 4, 5, 7 at ON, others at OFF.

3.2.2 Functions

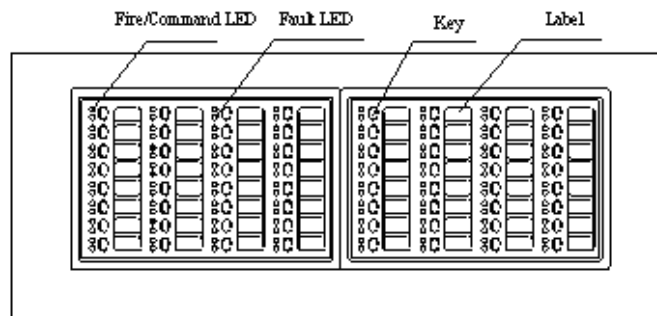
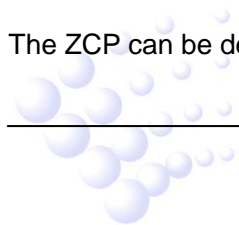

Fig. 3-3

Each switch includes a red LED, a yellow LED, a key (which can directly initiate connected devices) and a label (brief description of the start key).

The ZCP can be defined as three operation modes:



a) Zone direction mode [ZoneDir]

When fire occurs in a zone, corresponding red LED is lit and the sounder strobe is automatically initiated; when fault occurs, corresponding yellow LED flashes; when disabling all devices in the zone, corresponding yellow LED is constantly lit.

When pressing the key of the zone, the sounder strobe is initiated; press again, it is stopped.

b) Silence mode [Silence]

Press this key, all connected sounder strobes are silenced and red LED lit; press it again, the silenced sounder strobes sound again, and red LED goes out. In silence mode, when new alarm occurs, all silenced sounder strobes activate again.

c) Point device mode

Single startable devices can also be defined on the ZCP. Press the key, corresponding device is initiated and red LED is lit. Press the key again, corresponding device stops, red LED goes out.

3.3 Configuration

3.3.1 Typical Configuration

(1) Wall-mounted GST5000W FACP

A typical FACP system consists of a control cabinet, a loop interface board, a P.S.U system, display and operation area and a ZCP.

① Control cabinet

Cabinet is the core part of the FACP, mainly consisting of 3 parts: motherboard, main board, and loop card. RS232 and RS485 communication cards can be inserted like in Fig. 3-4.

A: Motherboard Illustration

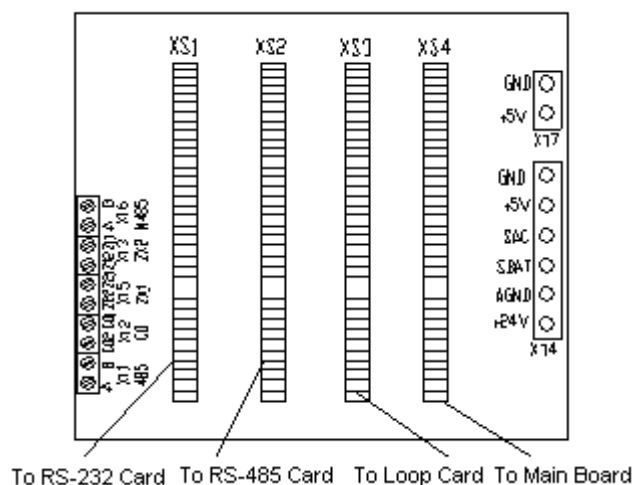

Fig. 3-4

Fig. 3-4 shows the structure of the motherboard installed on the bottom of the control part. It connects with the AC-DC100W power supply through terminals. There are 4 channel slots for plugging main board, loop card and 232 and 485 communication cards.

XT4: Connecting with AC-DC100W power supply.

XT7: Connecting with switchboard.

B: Illustrations of main board, loop card and communication card

Appearances of main board, loop card and communication card are shown in Fig. 3-5.

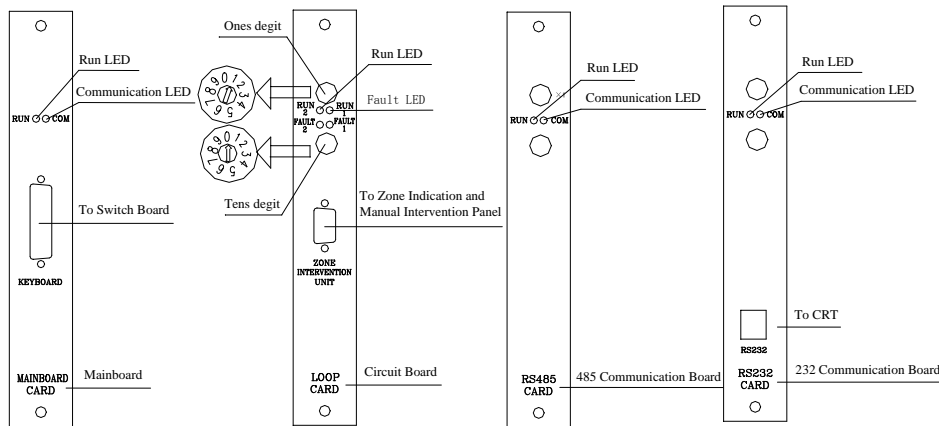

Fig. 3-5

There are two code switches on each loop card and communication card respectively, representing tens digit and ones digit. They are used to set the channel number of loop card and communication card. The loop card is of dual-channel. The code switch sets the channel number of the first channel, and automatically adding 1 for the second channel. The numbers of communication card and loop card can be mixed randomly.

Example: On code switch of loop card, tens digit is 0, ones digit is 1. The channel number of the first loop is 1, and that of the second loop is 2.

② **Loop interface board**

It is signal interface board of the FACP, which has communication port, detecting port, fire alarm output port, fault output port and etc. The loop interface board makes field devices and the FACP compose a whole fire alarm system.

③ **Power supply**

It provides the control cabinet, loop interface board and printer with voltage. Non-lost electricity ensures that all the registered devices being monitored after commission.

④ **Display and operation area**

It can indicate and show all kinds of status information resulting from operations from

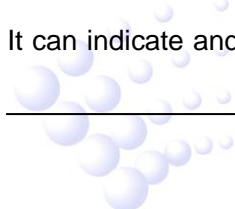

keypad (such as browsing, setting, and printing).

⑤ **Zone indication and manual intervention panel (ZCP)**

Indicating fire, and fault/disablement of corresponding devices, and starting or stopping them.

(2) **Typical configurations of GST5000 rack type and console type:**

Comparing with wall mounted type, the rack and console types can have more loop cards connected to the control cabinet and an intelligent PSU is used.

① **Control Cabinet**

Main control unit is the core part of the control panel, including motherboard, main board, 232 communication card, 485 communication card and loop card.

A: Motherboard

Fig. 3-6 shows the structure of the motherboard of the control panel installed on the bottom of the control part. It connects with the DC-DC convertor through terminals. There are 10 channel slots for plugging main board, loop card and communication cards. The control panel is expandable to at most two motherboard boxes.

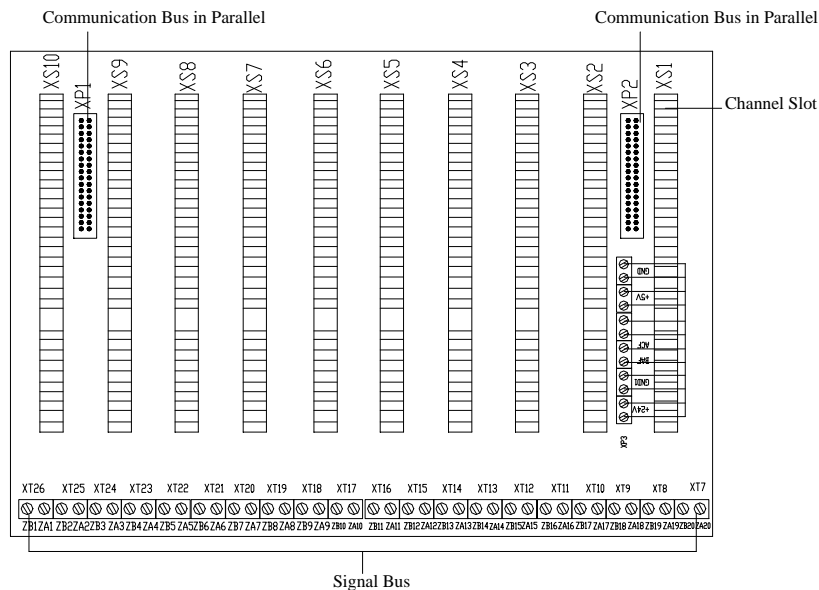

Fig. 3-6

- ✧ Communication bus in parallel: Used for system extension
- ✧ Channel Slot: Used to plug main board, loop card and communication card on.
- ✧ XP3: Connecting with DC-DC convertor
- ✧ ZAn, ZBn (n=1~20) : 1~10 channel signal bus terminals

Note: When DC-DC convertor is switched off, loop 24V is not cut off. If you want to plug in or pull out the circuit boards in the main unit, please disconnect main and standby power.

B: Main board, loop card, communication card

Appearances of main board, loop card and communication card are the same as GST5000W wall mounted control panel.

C: Illustration of DC-DC Converter

DC-DC converting module is shown in Fig. 3-7.

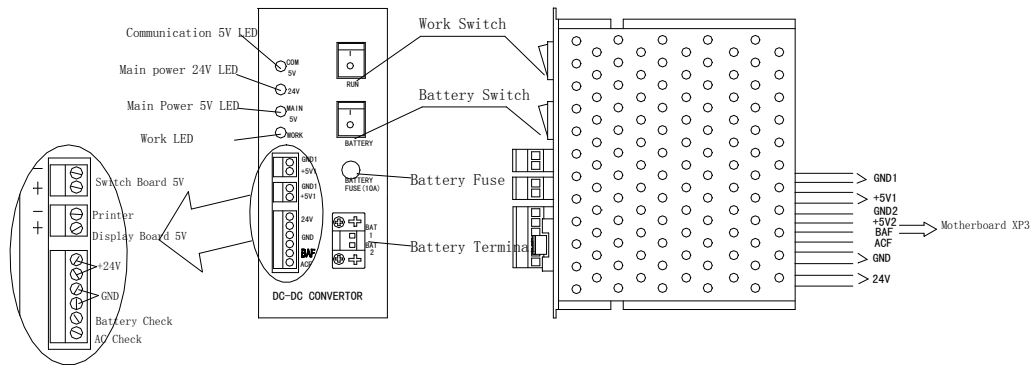

Fig. 3-7

② PSU24-6RM Intelligent PSU

PSU24-6RM intelligent PSU is used to supply power to modules and corresponding controlled devices.

PSU24-6RM is shown in Fig. 3-8.

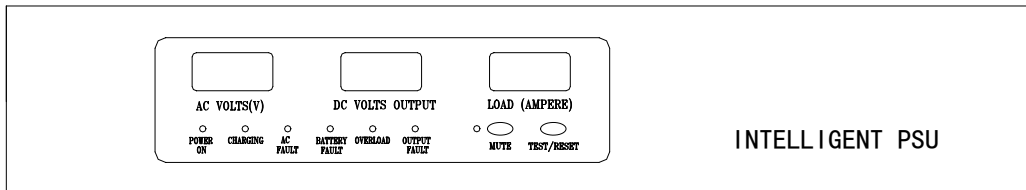

Fig. 3-8

A Indicators and switches:

- ✧ MUTE Key: Pressing *MUTE* can silence the PSU panel when fault occurs. The sound will resume when new fault occurs.
- ✧ TEST/RESET Key: Under monitoring state, this is *TEST* key, testing all display components as pressing it, which should be normally lit; after self-test, press *TEST* key again, it will self-test again. Under fault state, this is *RESET* key to clear the fault. *RESET* key can clear the fault display and fault alarm sound.
- ✧ POWER ON LED: Green. For AC power indication.
- ✧ CHARGING LED: Green. Indicating the charging mode.
- ✧ AC FAULT LED: Yellow. Lit when AC power voltage is higher than 260VAC or

lower than 160VAC. The buzzer will alarm at the same time.

- ✧ BATTERY FAULT LED: Yellow. Lit when battery voltage is lower than 15VDC or higher than 28VDC. The buzzer will alarm at the same time.
- ✧ OVERLOAD LED: Red. Lit when battery voltage is higher than 28VDC. The buzzer will alarm at the same time.
- ✧ OUTPUT FAULT LED: Yellow. Lit when a break or short circuit occurs or output current is higher than 8A. The buzzer will alarm at the same time.
- ✧ MUTE LED: Red. Lit when in mute state.
- ✧ Display windows indicate the input AC voltage, output voltage and output current.

B Terminals

Back of the PSU and terminals are shown in Fig. 3-9.

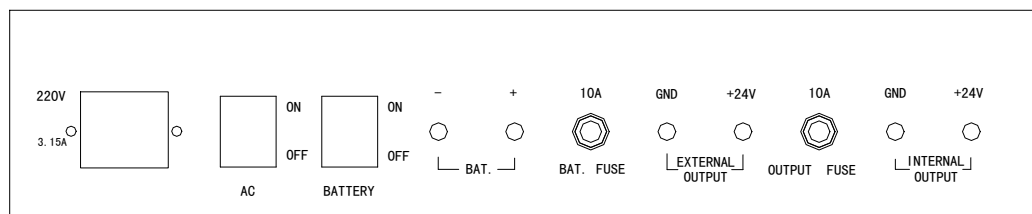

Fig. 3-9

- ✧ AC ON/OFF: AC ON applies AC power, and AC OFF disconnects AC power.
- ✧ BATTERY ON/OFF: BATTERY ON applies battery, and BATTERY OFF disconnects battery.
- ✧ +, - (BAT.): Battery input.
- ✧ +24V, GND (EXTERNAL OUTPUT): 24VDC main output.
- ✧ +24V, GND (INTERNAL OUTPUT): 24VDC multi-wire power output.
- ✧ AC socket: 220V/230VAC power input (including chassis earth).

3.3.2 Optional Configuration

(1) Fireman's Control Panel (FCP)

Fireman's Control Panel is an important device in the system. These devices include fire pump, smoke exhauster and blower. The FCP of GST5000 intelligent fire alarm control panel can control at most 12 equipments by option. For devices needing both start and stop, it can control at most 6. The panel can check short circuit and broken circuit with corresponding audio and visual instruction, which can ensure the reliability of connection between the control panel and important devices as much as possible.

(2) Thermal Printer

The thermal printer adopts special structure to be installed on a small mounting hole

(103mm×57mm) on the front panel of the control panel. The printer is made up of front cover, rack, head, circuit, spindle and scroll. There are “SEL” and “LF” keys and indicators on the right-upper side of the front panel on the control panel, and paper-out slot with cutting saws on lower part. The printer head is installed in the rack, and at the bottom of the head is paper-in slot. Fix the printer on the panel with flexible bars. Place the scroll spindle on the rack. The rack and printer can be simply pulled out or plugged into the control panel for changing paper.

(3) Communication Card

GST5000 Intelligent Fire Alarm Control Panel provides a multi-functional communication port, connecting with network cards to realize networking among GST series fire alarm control panels, to form urban fire alarm supervisory network through public telephone network and to fulfill graphic supervision by connecting with CRT system in the control center of buildings. The control panel watches network cards running in real time, that is, the cards can take effect as inserted.

Note: You need to purchase a CRT card for your first order of GST5000. Only with this CRT card, device definition and C&E equations can be downloaded from PC.

3.4 Field Devices

3.4.1 A Series of Intelligent Fire Detectors

GST 5000 can connect with a series of fire detectors, such as I-9102, I-9103, and I-9105R. The detectors installed in the protected area transmit monitoring message to the FACP through Class A loop. Every detector has its own address with which the FACP can supervise the information of alarm, fault, and normal status of the detectors.

3.4.2 Modules

GST5000 can connect with I-9300 addressable input module and I-9301 addressable single I/O module. I-9300 module receives the signal of normally open switching signal, and transmits the information to the FACP (This type of FACP is able to activate the connected devices). I-9301 single I/O module connects with the devices controlled by the FACP, such as smoke exhauster, fan blower and fire valve. It can also receive the self-answering signal.

3.4.3 Loop Isolator

Loop Isolator can disable the shorted part of loop from the whole system to ensure normal operation of other devices and to ascertain the location of the part in fault. When the fault is repaired, the loop isolator can automatically reset the disabled part and include it into the system.

3.4.4 Manual Call Point

A series of manual call point (such as I-9202) can be connected with the bus of GST5000. When fire is confirmed manually, press the glass on the MCP, alarm signal can be sent to the FACP. After receiving the alarm signal, the FACP will show the number and location of the MCP, and sound alarm.

3.4.5 Addressable Sounder Strobe

Addressable Sounder Strobe is a kind of audible/ visual alarm device installed in field, which can be activated by FACP in fire control center or by manual call point installed in field. A series of GST addressable sounder strobes (such as I-9403) can be connected to the bus of GST5000. Having been activated, it will generate strong audible/ visual alarm signal to warn people in field.

3.4.6 GST852RP Repeater Panel

GST852RP Repeater Panel is designed with a microprocessor. When one or more detectors alarm fire, the repeater panel can display the location numbers and information of the detectors and send out audible and optical signals. Through communication loops, it can be connected with FACPs, disposing and displaying the data transmitted from the FACPs. When monitoring several floors or several zones with one FACP, a repeater panel on each floor or in each zone can replace zonal FACPs.

3.5 C&E Equation and Device Definition Software

The software owns the functions of editing and downloading definition of device and C&E equation. Before the system starts operation, you need to define the device and C&E through configuration software via computer and then download it to the FACP.

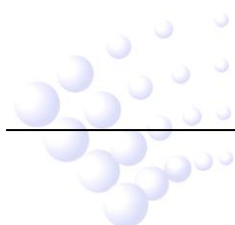

Chapter 4 Mounting

Follow the steps before mounting the GST5000:

- (1) Check whether you have received all items ordered.
- (2) Mount the cabinet.
- (3) Power up the FACP and carry out start-up inspection.
- (4) Connect field devices.
- (5) Inspect circuits and register devices.
- (6) Define the devices and download them to the FACP through the configuration software by PC according to engineering configuration.
- (7) Define C&E equation and download it to the FACP through the configuration software by PC according to engineering configuration.
- (8) Commission and inspect field devices.

4.1 Configuration Inspection

4.1.1 Check Engineering Configuration

Check the configuration according to packing list. The main items to be examined are: Installation and Operation Manual, keys to the FACP, etc.

4.1.2 Check Internal Configurations and Interconnection of the FACP

All internal parts have been connected completely (including optional units) before the FACP leaves the factory. Therefore, mainly check the internal parts and connection according to Appendix 1.

4.2 Installation of the Cabinet

4.2.1 Installation condition and method of wall-mounted FACP

The dimension of wall-mounted FACP is shown in Fig. 4-1.

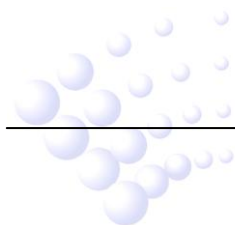

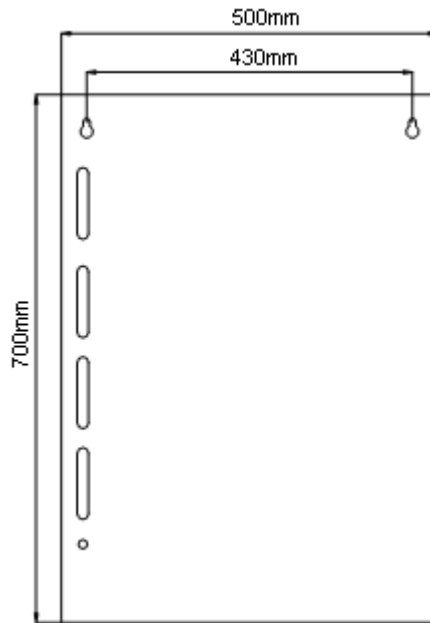

Fig. 4-1

4.2.2 Installation condition and method of rack type and console-typed FACP.

Rack (L×W×H): 580mm×520mm×1540mm (or 1715mm)

Console(L×W×H, single unit): 555mm×933mm(with table)×1350mm

Console(L×W×H, double unit):1045mm×933mm (with table)×1350mm

Ambient Temperature: 0℃~+40℃

Relative Humidity≤95%, non-condensing

Installation Space: Width of maintenance of the FACP should be more than 1000mm.

4.3 Start-up Check

After mounting GST5000, apply power to it as shown in Fig. 4-2. Turn on the mains and battery switch in the cabinet and check if the FACP can self-test. The procedures are as follows.

- (1) Check LCD, digitron and indicators.
- (2) Check self-test on the stored running records, disablement information and C&E equations.
- (3) Observe whether the indicators, and digitron on the FACP and ZCP can all be lit and whether the speaker gives three continuous alarm sounds and “beep” tone.

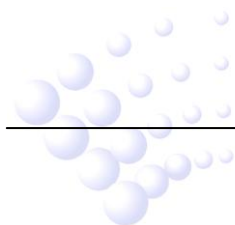

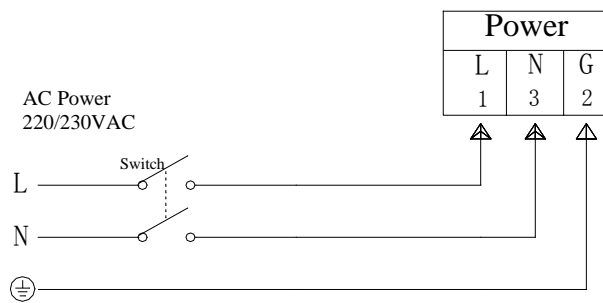

Fig. 4-2



Caution: Do not connect power to your device until you have completed all input and output connections. Fail to do so may result in injury!

4.4 Connections of Field Devices

Loop interface board combines GST5000 FACP and field devices.

Terminals of loop interface board are shown in Fig. 4-3.

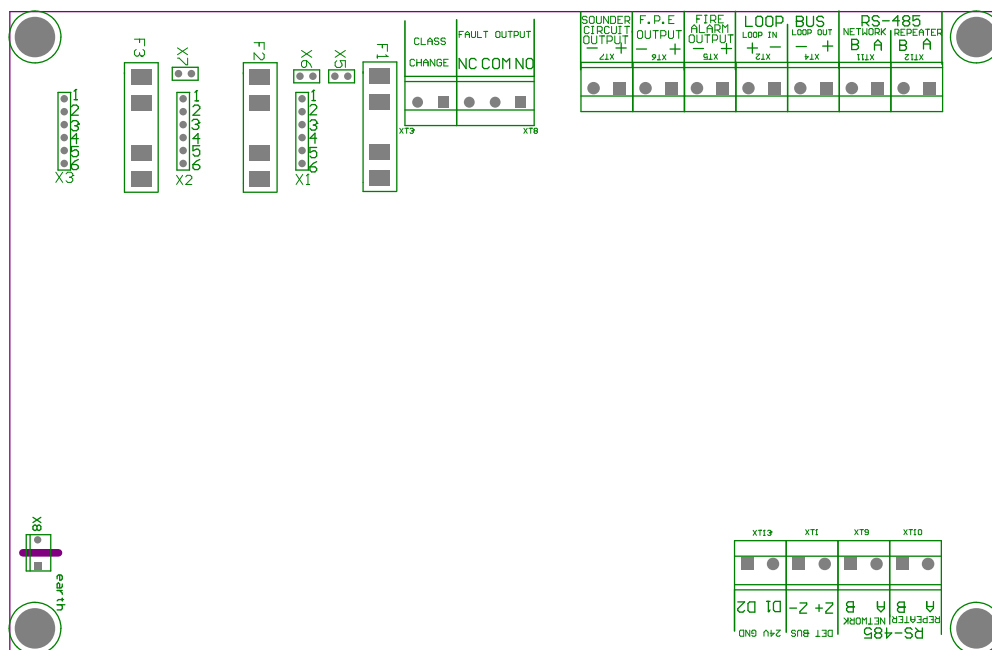

Fig. 4-3

Description:

- ✧ CLASS CHANGE (XT3): Short it to make the sounders output.
- ✧ FAULT OUTPUT (XT8): Normally open contact is closed when fault signal

occurs, and normally open contact is disconnected when the FACP repairs fault automatically.

- ✧ SOUNDER CIRCUIT OUTPUT (XT7): It outputs when there is fire alarm. It can be stopped by pressing *SILENCE* key on ZCP. Output can be disabled, and there is no output in disabled state. The FACP will report fault when connected cable in short or open circuit.
- ✧ F.P.E. OUTPUT (XT6): It outputs when there is fire alarm. It can be disabled, and does not output when fire alarm occurs in disablement state. The FACP alarms fault when connected cable in short or open circuit.
- ✧ FIRE ALARM OUTPUT (XT5): It outputs when there is fire alarm and should give fault signals when connected circuit is shorted or opened.
- ✧ LOOP BUS (XT2, XT4): It can be connected with 235 coded points. With loop isolator in the ring detection loop, the detector protected by loop isolator is not missing when there is short or open circuit. In this case, the FACP reports fault.
- ✧ RS-485 (XT11, XT12): To be connected with repeater panel and FACP.
- ✧ earthX8: This terminal is for checking earth fault when there is short circuit.

F.P.E. OUTPUT, SOUNDER CIRCUIT OUTPUT, FIRE ALARM OUTPUT can provide three output modes: 24VDC active output, normally open output and normally closed output. You can set up the three modes through Pin X1~X7. See more details in Table 4-1.

Table 4-1

Output	24VDC	Normally Closed	Normally Open
F.P.E. Output	Short 1 to 2 & 4 to 5 of X3 Short X7	Short 3 to 4 & 5 to of X3 Disconnect X7	Short 2 to 3 & 5 to 6 of X3 Disconnect X7
Sounder Circuit Output	Short 1 to 2 & 4 to 5 of X2 Short X6	Short 3 to 4 & 5 to 6 of X2 Disconnect X6	Short 2 to 3 & 5 to 6 of X2. Disconnect X6
Fire Alarm Output	Short 1 to 2 & 4 to 5 of X1. Short X5	Short 3 to 4 & 5 to 6 of X1. Disconnect X5	Short 2 to 3 & 5 to 6 of X1 Disconnect X5

4.4.1 Connection of Sounder Circuit Output

Connection of Sounder Circuit Output is shown in Fig. 4-4.

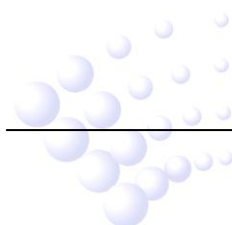

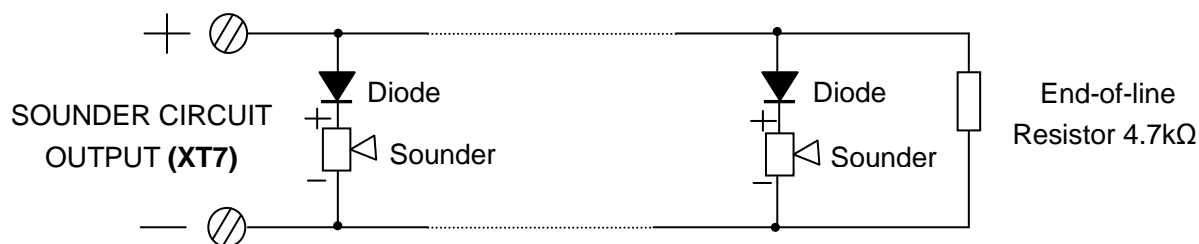

Fig. 4-4

Description:

A 4.7kΩ resistor is connected at the SOUNDER CIRCUIT OUTPUT as factory default. Please remove it and keep it well before connection. After connecting the loop in correct polarity, add the resistor to the end of the line

NOTE: The sounder strobes are polarized. Note polarity in connection. The maximum current of the circuit depends on the number of sounder strobes. Do not overload.

4.4.2 Connection of F.P.E. Output

F.P.E. output is shown in Fig. 4-5.

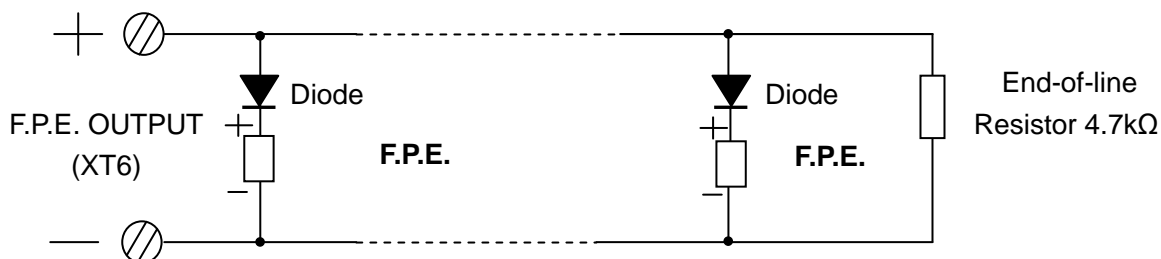

Fig. 4-5

A 4.7kΩ resistor is connected at the F.P.E. OUTPUT as factory default. Please remove it and keep it well before connection. After connecting the loop in correct polarity, add the resistor to the end of the line.

NOTE: F.P.Es are polarized. Note polarization in connection. The maximum current of the circuit depends on the number of F.P.E. Do not overload.

4.4.3 Connection of Fire Alarm Output

Fire alarm output is shown in Fig. 4-6.

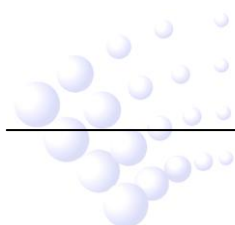

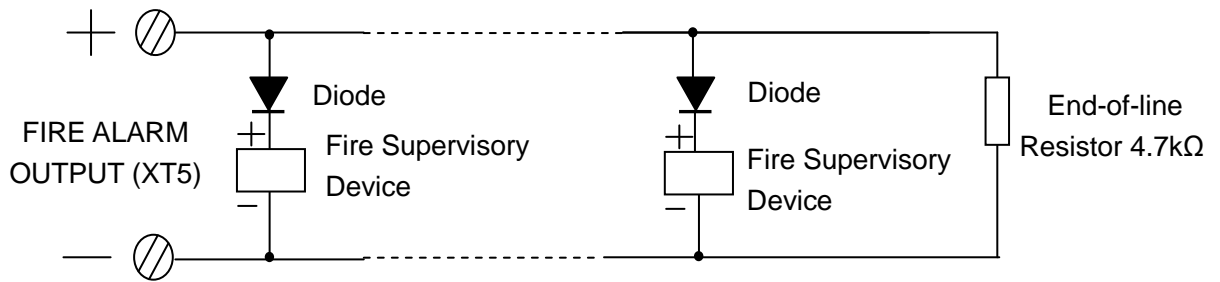

Fig. 4-6

A 4.7kΩ resistor is connected at the FIRE ALARM OUTPUT as factory default. Please remove it and keep it well before connection. After connecting the loop in correct polarity, add the resistor to the end of the line.

NOTE: Fire supervisory devices are polarized. Note polarity in connection. The maximum current of the circuit depends on the number of fire supervisory devices. Do not overload.

4.4.4 Connection of Class A Loop

A Class A loop is shown in Fig. 4-7.

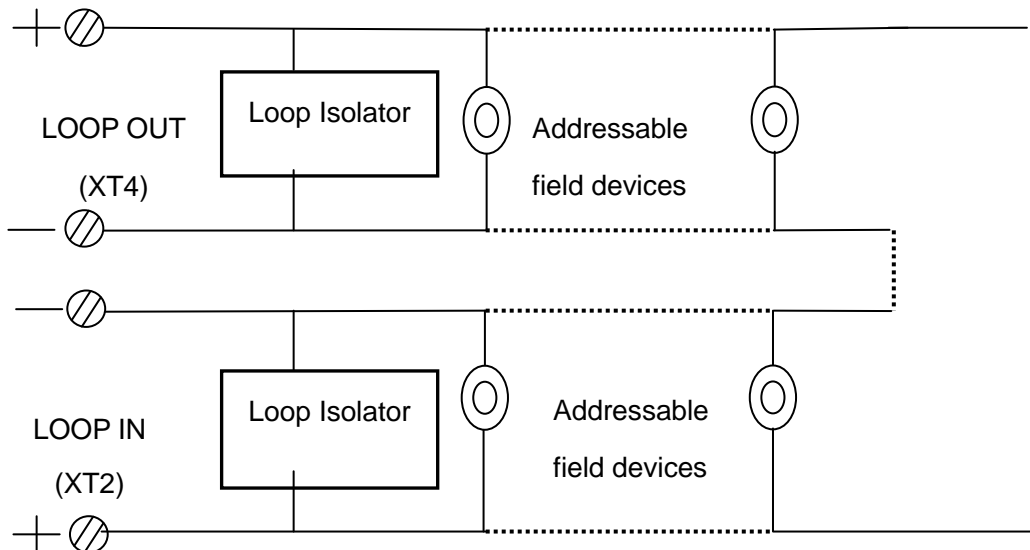
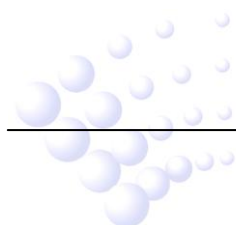

Fig. 4-7

Note: Every loop isolator can control maximum 32 detectors.

4.4.5 Connection of Communication Loop



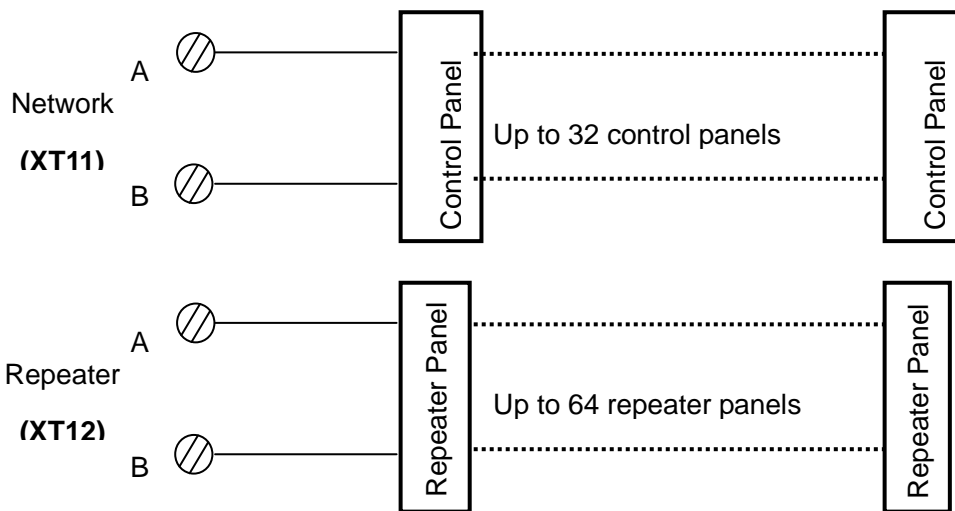

Fig. 4-8

4.4.6 Connection of Ring Module

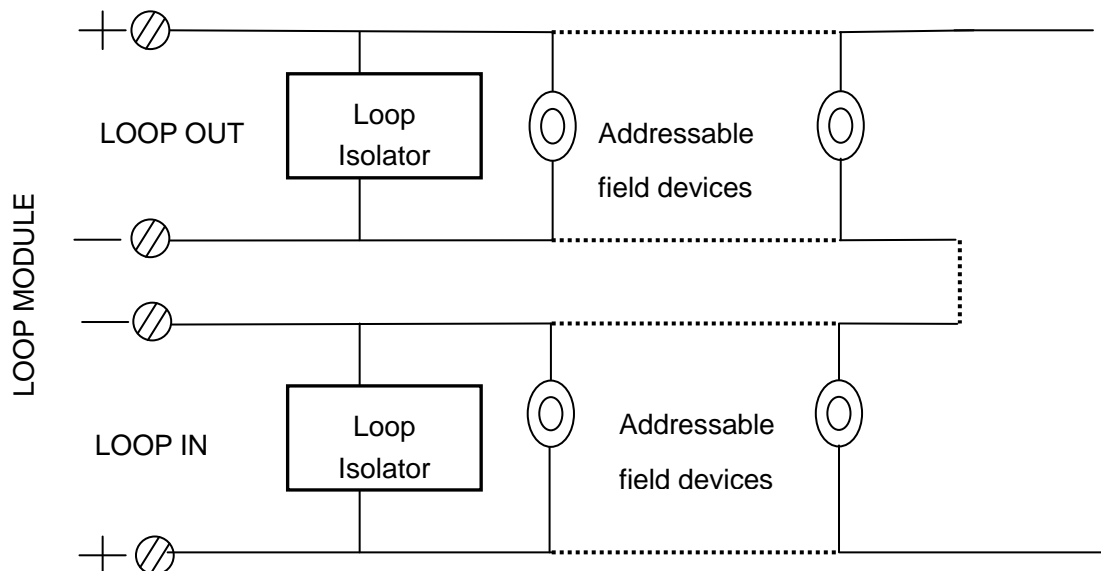

Fig. 4-9

Note: Every loop isolator can control maximum 32 detectors.

4.5 Connection Inspection and Device Registration

4.5.1 Connection Inspection

Check the circuit connected with the FACP. Insulation resistance measured at different circuits and ground should be more than 20MΩ, the resistance in the detection loop should be more than 1kΩ. The resistance among fire alarm output, sounder circuit output, F.P.E. output should be equal to end-of-line resistor.

4.5.2 Registration of Devices

Step One: Set the FACP at commissioning state.

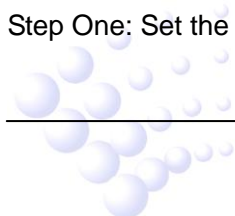

Press *SYSTEM* to enter system setting menu and choose “3.Working state setup” (Fig. 4-10):

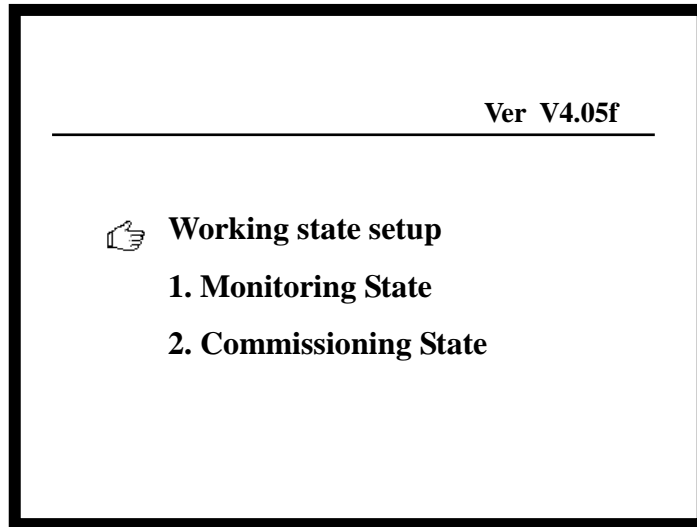

Fig. 4-10

Press “ Δ ” or “ ∇ ” to make the cursor point to “2.Commissioning State”, and press *ENTER* to enter commission state. The screen like Fig. 4-11 will be shown on the LCD.

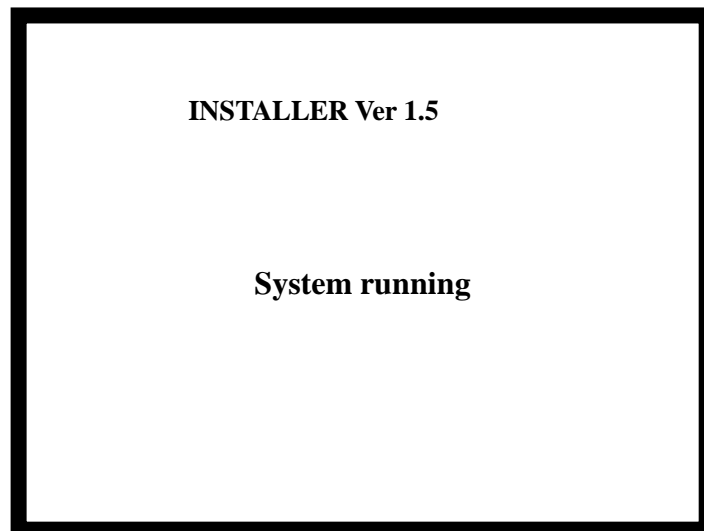

Fig. 4-11

Step Two: In commission state, re-start the FACP.

GST5000 FACP will automatically register devices. Please check the number of devices registered, programming, and operation state comply to design requirement, and remove any problem.

4.6 Definition of Devices

Please define devices and C&E equation by configuration software GSTDef2.0 via a PC,

and download the definitions to the FACP.

Please refer to *GSTDef2.0 Defining Tool User's Manual* for the installation, operation and commission of the software.

4.6.1 Browsing Zone Definition

The zone information defined by the definition software can be browsed on the LCD of the FACP following the steps below.

Step 1: Pressing *SYSTEM* to enter system setting menu, as in Fig. 4-12.

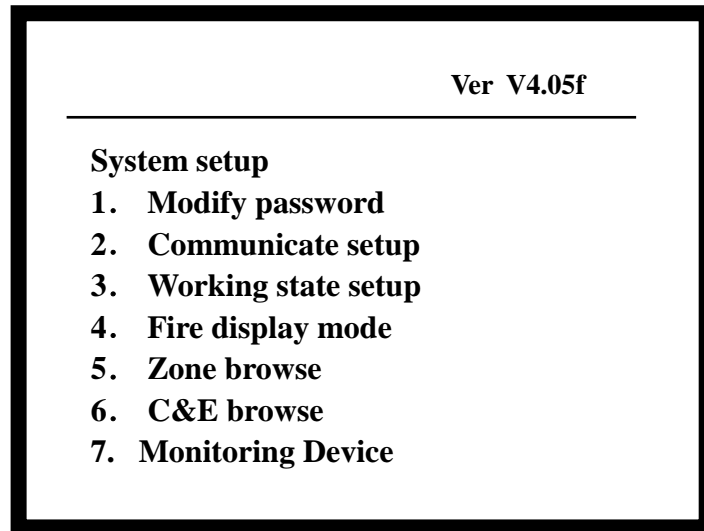

Fig. 4-12

Step 2: Choosing "5. Zone browse" can browse the zone definition as shown in Fig.4-13.

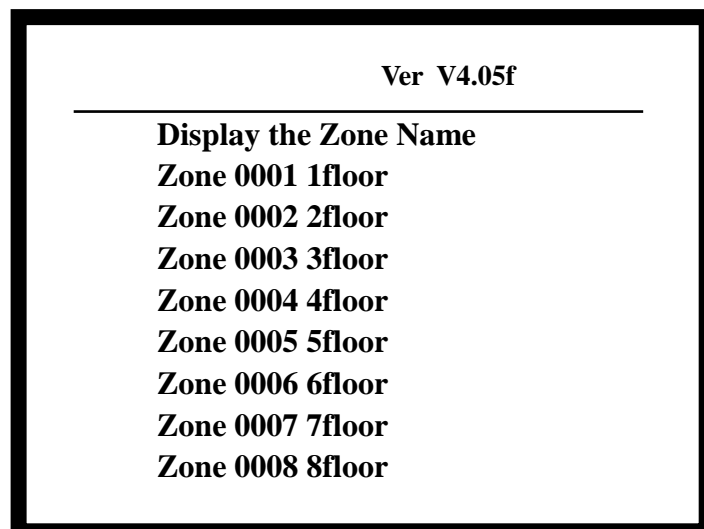

Fig. 4-13

Notes:

- ✧ Zone 0001 1floor// Zone number and descriptions.

✧ \triangle and ∇ can be used for turning pages.

4.6.2 Browsing Device Information

The device information defined by the definition software can be browsed on the LCD of the FACP following the steps below.

Step 1: Press *BROWSE* will enter the screen shown in Fig. 4-14. All system configurations will be displayed.

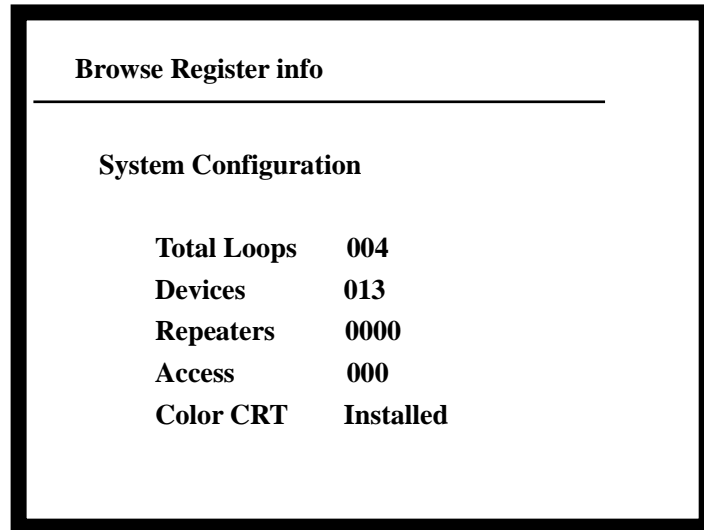

The screenshot shows a screen titled "Browse Register info" with a horizontal line below the title. Underneath, the text "System Configuration" is centered. Below this, there is a list of system parameters and their values:

Total Loops	004
Devices	013
Repeaters	0000
Access	000
Color CRT	Installed

Fig. 4-14

Step 2: Check loop configuration.

Pressing any key in the screen shown in Fig. 4-14 will enter the screen displaying loop configuration, with the top line highlighted. Pressing *TAB*, the highlight will disappear and the FACP will check the loop. Pressing \triangle and ∇ will move the highlight bar on different loops (Fig. 4-15).

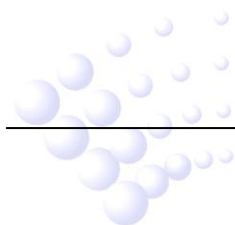

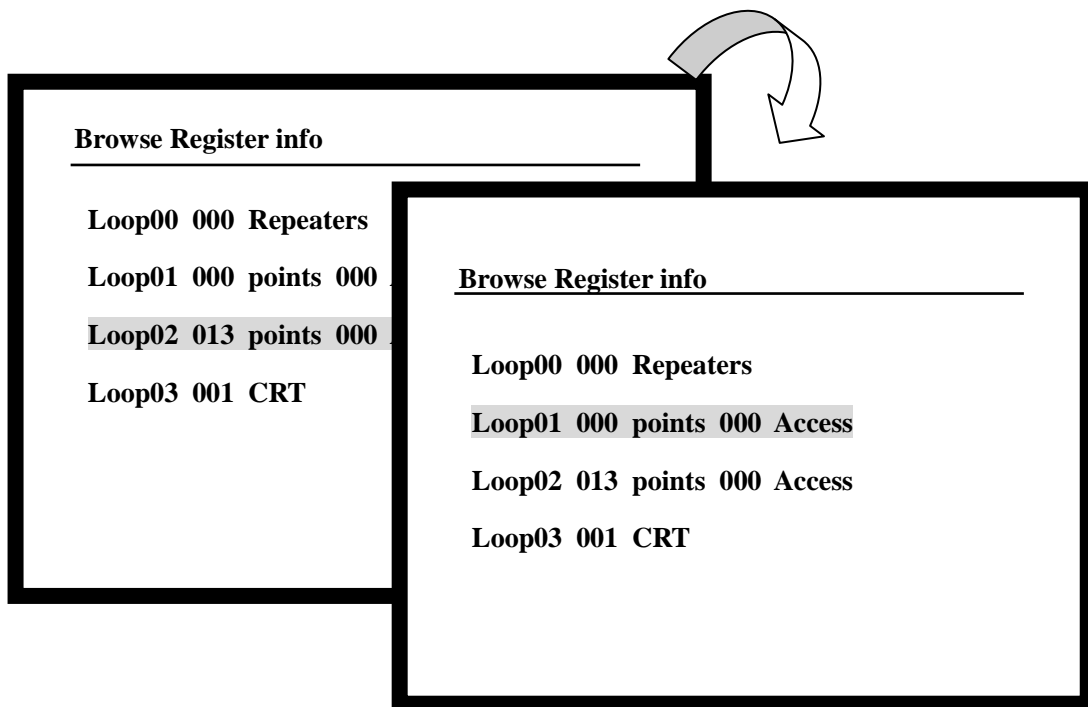

Fig. 4-15

Step 3: Checking device information.

Pressing *ENTER* will display the device information registered by this loop. The top line will be highlighted. Pressing *TAB*, the highlight disappears, and the FACP will check devices (Fig. 4-16).

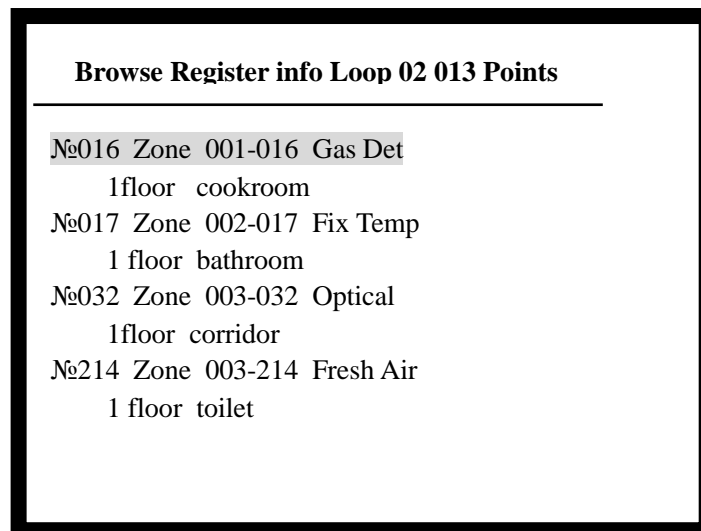
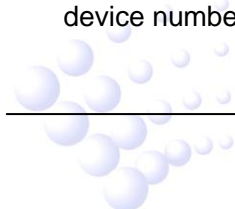

Fig. 4-16

Descriptions:

- ✧ №016 Zone 001-016 Gas Det // Message number, user code (zone number + device number), device type



- ✧ 1 floor cookroom// Zone description + device description
- ✧ №017 Zone 002-017 Fix Temp// Message number, user code (zone number + device number), device type
- ✧ 1 floor bathroom// Zone description + device description
- ✧ №032 Zone 003-032 Optical// Message number, user code (zone number + device number), device type
- ✧ 1 floor corridor // Zone description + device description
- ✧ №214 Zone 003-214 Fresh Air// Message number, user code (zone number + device number), device type
- ✧ 1 floor toilet// Zone description + device description

In device browsing state, pressing Δ and ∇ can turn pages. In device selection state, pressing Δ and ∇ can change the selected device.

4.6.3 Viewing C&E

The C&E equations defined by the definition software can be browsed on the LCD of the FACP following the steps below.

Step 1: Pressing *SYSTEM* will enter system setting menu as shown in Fig. 4-12.

Step 2: Choosing "6. C&E browser", the screen for browsing C&E will show. Pressing "1" can display the C&E for gas extinguishing devices, and pressing "2" will display ordinary C&Es (Fig. 4-17). Pressing *ENTER*, the screen prompts "Please Input the number", and you can view the C&E by entering its number.

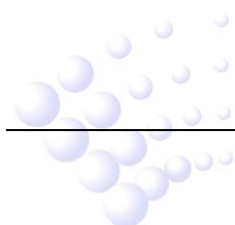

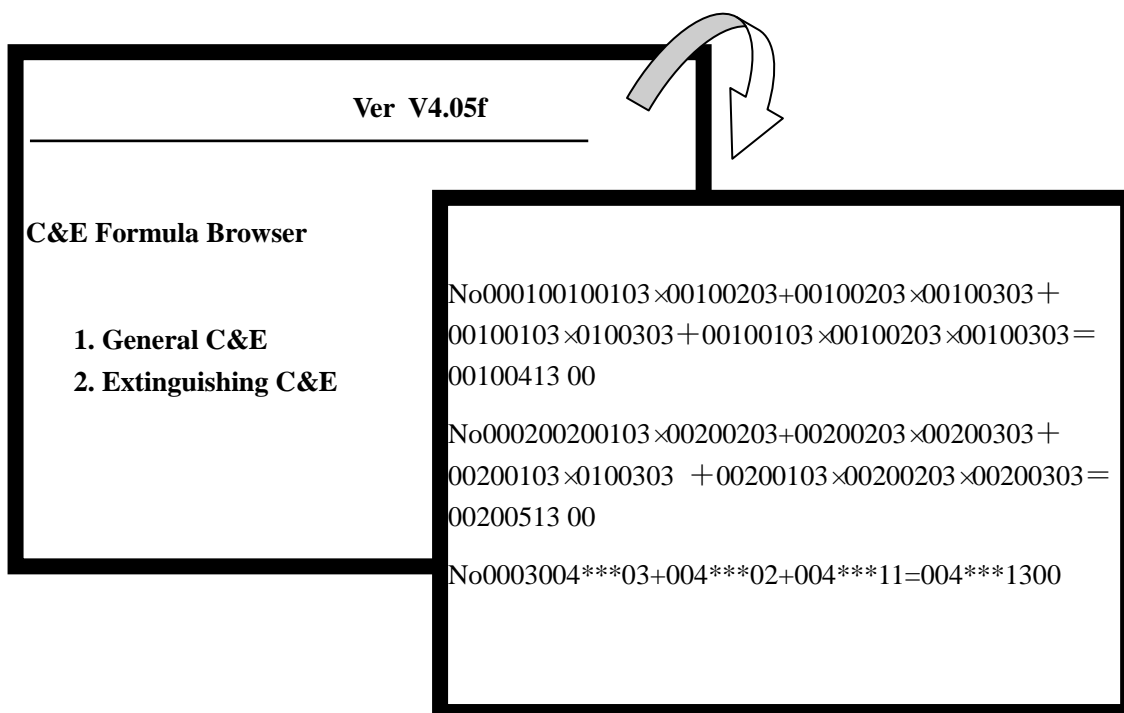
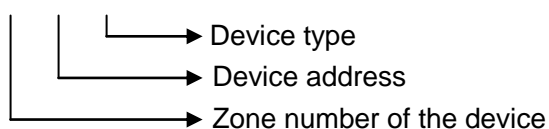

Fig. 4-17

Meaning of the above C&E:

- The part before the "=" refers to the condition, and the part after "=" is the result.
- "×" means "and" and "+" means or.
- NO.0001 refers to the first piece of C&E.
- Composition of the condition part of the C&E.

001 001 03



- Composition of the result part of the C&E.

001 004 13 00

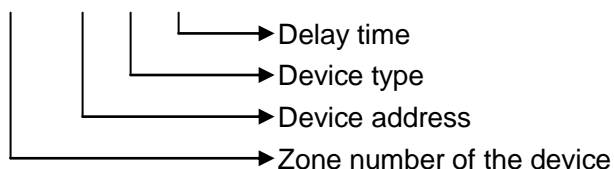

- In the third piece of C&E in the above figure,

No0003004***03+004***02+004***11=004***1300

This is a C&E with foggy devices, in which "*" is an asterisk mark representing any number from 0 to 9. The meaning of this C&E is: If there is any photoelectric smoke detector or any rate of rise and fixed temperature heat detector alarms or any manual call point from Zone No. 4, the sounder strobe of that zone will be started.

Step 3: Viewing spaces for the C&Es.

Pressing "3" in Fig. 3-11 can view the spaces for C&Es, as in Fig. 4-18.

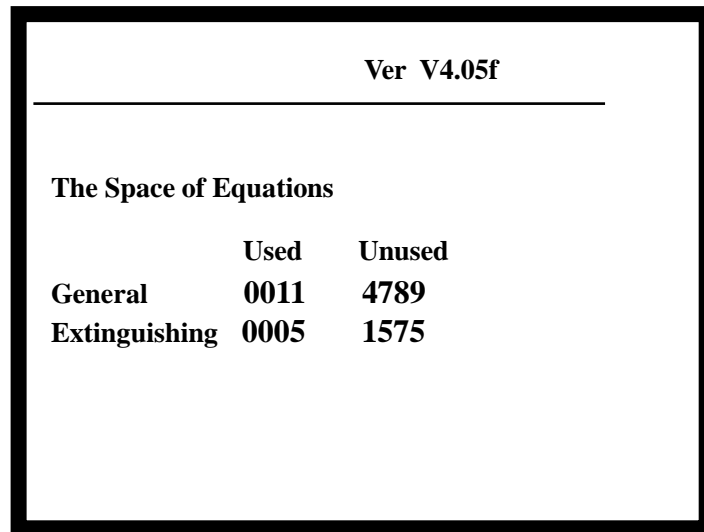

	Used	Unused
General	0011	4789
Extinguishing	0005	1575

Fig. 4-18

4.7 Field Devices Commission

After connection of cables, definition and download of device and C&E equations, you can power up the FACP and start commission. The following steps are for reference.

1. Enter commission state according to Section 4.5.
2. Check whether the loop devices registered are the same as real connection. If most of devices are found missing, check the power supply and loop isolators first, then come to individual device. Press *SELF TEST* key to check field device registration.
3. Check whether registration of repeater panels is the same as the actual. If there is any problem, check the communication cable A and B and 24V power supply.
4. Label the ZCP at the correct places.
5. Carry out detector alarm test and repeater panel transmitting test.
6. Check device definition and execute C and E automatic linkage test.
7. Connect important devices (such as gas extinguishing control panel) and train the operators.

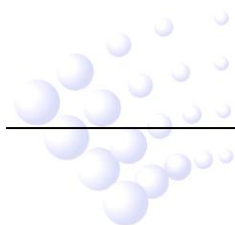

Chapter 5 Display and Disposal of System Information

GST5000 can be started after mounting according to Chapter 4.

5.1 Normal Information

Turn on the external power switch, and main and standby power switch on the FACP, the control panel executes self-test and enters monitoring state. The system displays properly if it is in normal state, or the system displays improperly.

The normal display is shown in Fig. 5-1, which means the system is in working state. Then only *POWER HEALTHY* LED illuminates.

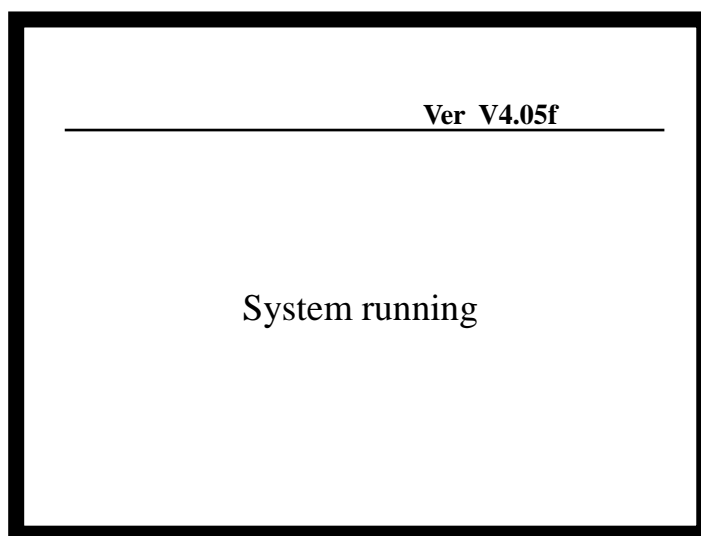

Fig. 5-1

5.2 Information of Fire Alarm

5.2.1 Fire Alarm Screen

FIRE LED is illuminates when there is fire alarm signal. Speaker of the control panel sounds (fire truck sound), and corresponding fire LED on the ZCP is also lit. There are two options for fire display, by zone and by device. In zone mode, only the 1st alarm in the same zone is displayed. All alarms will be displayed in device mode. Device mode is usually used for commission.

① Zone mode fire information shows in Fig. 5-2.

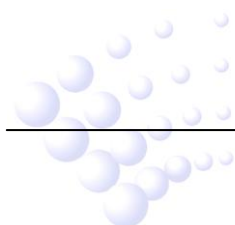

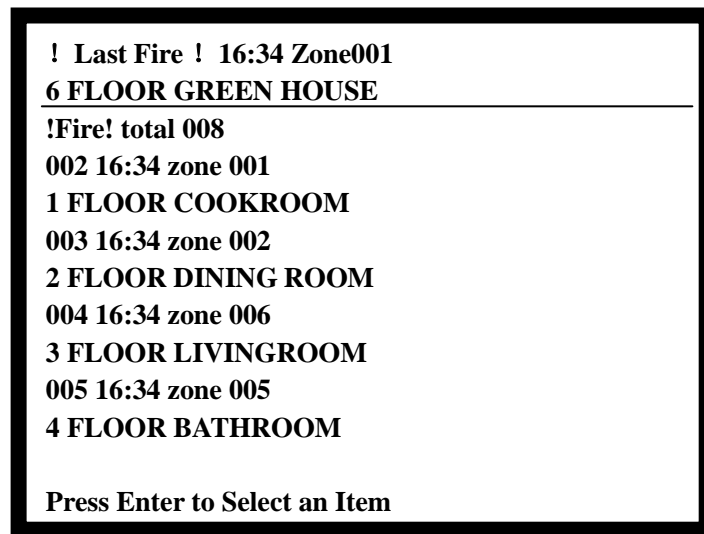
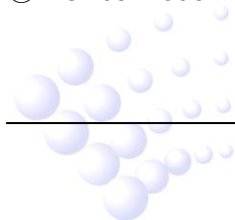

Fig. 5-2

Description:

- ✧ Last Fire 16:34 Zone001
6 FLOOR GREEN HOUSE //This is the last alarm. It happens in Zone001, at 16:34, the location is the GREEN HOUSE on the 6th floor.
- ✧ !Fire! total 008 //Total alarms. Each fire alarm message occupies two lines. You can view different fire message by pressing " Δ " and " ∇ ".
- ✧ 002 16:34 zone 001 //Time and zone of the second fire alarm
- ✧ FLOOR COOKROOM //Zone definition (first 8 digits) and device definition (last 32 digits)
- ✧ 003 16:34 zone 002// Time and zone of the third fire alarm
- ✧ FLOOR DINING ROOM// Zone definition (first 8 digits) and device definition (last 32 digits)
- ✧ 004 16:34 zone 006// Time and zone of the forth fire alarm
- ✧ FLOOR LIVINGROOM// Zone definition (first 8 digits) and device definition (last 32 digits)
- ✧ 005 16:34 zone 005// Time and zone of the fifth fire alarm
- ✧ 4 FLOOR BATHROOM // Zone definition (first 8 digits) and device definition (last 32 digits)
- ✧ Press *Enter* to Select an Item // Press *ENTER* to view a fire alarm message.

② Device mode fire information shows in Fig. 5-3.



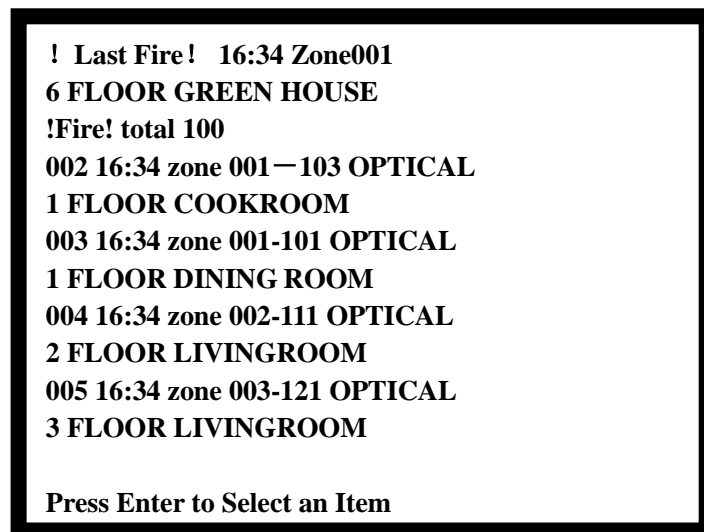

Fig. 5-3

Description of fire alarm screen:

- ✧ Last Fire 16:34 Zone001

6 FLOOR GREEN HOUSE // This is the last alarm. It happened in Zone001, at 16:34, the location is the GREEN HOUSE on the 6th floor.
- ✧ !Fire! total 100// Total alarms.
- ✧ 002 16:34 zone 001—103 OPTICAL//Time, zone device address and type of the second fire alarm.
- ✧ 1 FLOOR COOKROOM// Zone definition (first 8 digits) and device definition (last 32 digits)
- ✧ 003 16:34 zone 001-101 OPTICAL// Time, zone device address and type of the third fire alarm.
- ✧ 1 FLOOR DINING ROOM// Zone definition (first 8 digits) and device definition (last 32 digits)
- ✧ 004 16:34 zone 002-111 OPTICAL/ Time, zone device address and type of the forth fire alarm.
- ✧ 2 FLOOR LIVINGROOM // Zone definition (first 8 digits) and device definition (last 32 digits)
- ✧ 005 16:34 zone 003-121 OPTICAL// Time, zone device address and type of the fifth fire alarm.
- ✧ 3 FLOOR LIVINGROOM // Zone definition (first 8 digits) and device definition (last

32 digits)

- ✧ Press Enter to Select an Item //Press *ENTER* to view a fire alarm message.

5.2.2 Disposal of Fire Alarm Signal

When fire alarm occurs, first find out the location according to the information shown on the FACP to verify whether the fire really happened.

If it's a real fire, please take corresponding measures.

Step One: Evacuate the people in field.

Step Two: Call the fire department.

Step Three: Initiate extinguishers.

If it is a false alarm, please take the following measures.

Step One: Press *SILENCE* to stop the sound.

Step Two: Remove the factors that caused the false alarm.

Step Three: Press *RESET* to make the FACP back to the normal state. If the device still gives false alarm, disable it and inform the installer or manufacturer for repair.

5.3 Fault Information

5.3.1 Screen of Fault Information

When there are fault signals, different LEDs can be lit according to the type of fault. If it is mains fault, *AC FAULT* LED will be lit; if it is standby power fault, *BATTERY FAULT* LED will be lit; if it is system fault, *SYSTEM FAULT* LED will be lit; if it is field device fault, relative LED on the ZCP is lit. Speaker of the FACP gives alarm sound (ambulance sound).

Fault information can only be displayed by device, the screen is shown in Fig. 5-4.

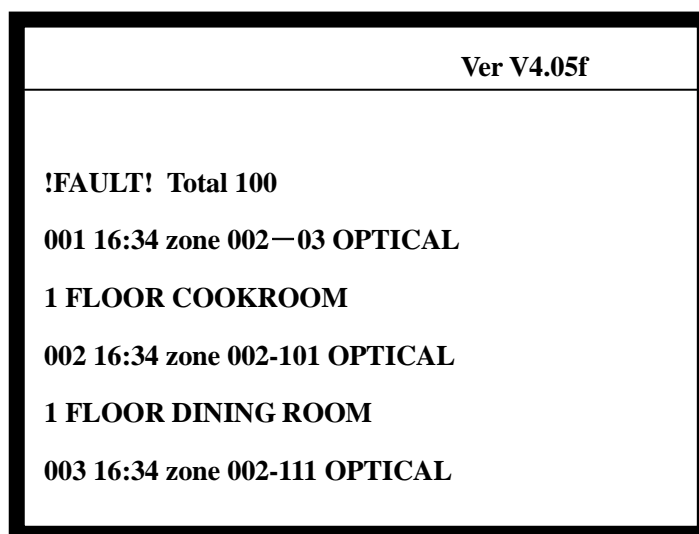

Fig. 5-4

Description of the fault screen:

Each fault message occupies two lines. You can view different fault message by pressing \triangle and ∇ .

- ◇ !FAULT! total 100//Total fault events.
- ◇ 001 16:34 zone 002—03 OPTICAL// Time, zone, device address and type of the fault event.
- ◇ 1 FLOOR COOKROOM// Zone definition (first 8 digits) and device definition (last 32 digits)
- ◇ 002 16:34 zone 002-101 OPTICAL// Time, zone, device address and type of the fault event.
- ◇ 1 FLOOR DINING ROOM// Zone definition (first 8 digits) and device definition (last 32 digits)
- ◇ 003 16:34 zone 002-111 OPTICAL// Time, zone device address and type of the fault event.
- ◇ 2 FLOOR LIVINGROOM // Zone definition (first 8 digits) and device definition (last 32 digits)

5.3.2 Disposal of Fault Information

There are two kinds of fault. One is system fault, such as AC power and battery fault, loop fault. The other is field device fault, like detector fault, module fault etc.

- ◇ If it is battery fault, charge storage battery in time to avoid damage. If the battery has powered the system overtime, the FACP will power down for protection.
- ◇ If it is system fault, check and repair in time. If power-down is needed, make detailed notes.
- ◇ If it is field device fault, it should be repaired immediately. You can disable it if the fault cannot be cleared for some reason. Then enable it when the device fault is repaired.

5.4 Disable and Enable

5.4.1 Use of Disable/Enable

When some problems happen to the field device, it may be necessary to disable the device for maintenance, and then re-enable it after repairing or replacing.

5.4.2 Disable/Enable Devices

1) Disabling a device

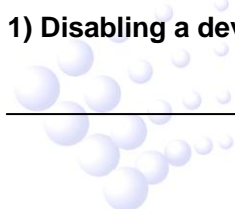

DISABLED LED will be lit if the device is disabled.

Pressing *DISABLE* key, the screen will show as in Fig. 5-5.

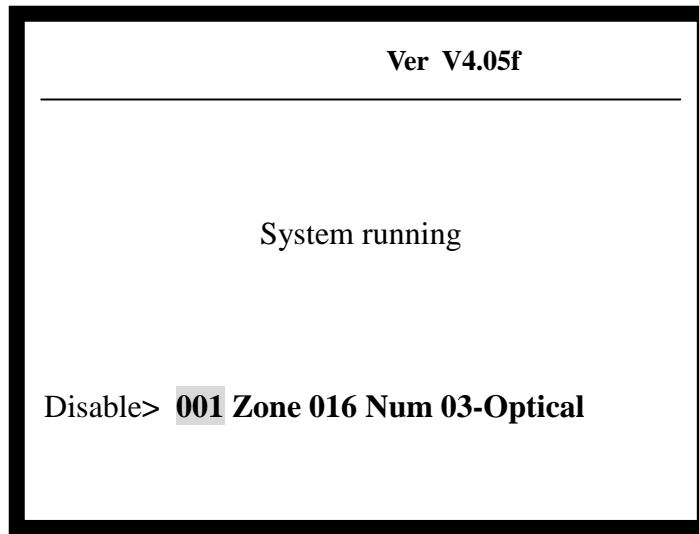

Fig. 5-5

Suppose user code of the optical smoke detector to be disabled is 001016. The steps for disablement are as follows:

Step One: Input zone number “001” of the device.

Step Two: Press *TAB*, the highlight position moves to next input zone.

Step Three: Input device code number “016”.

Step Four: Referring to “Appendix 2 Device Type List”, input the device type “03”.

Press *ENTER* to save. If the device has been disabled, the screen will show “Input Err”, if not, the screen will add the device to the disablement information.

2) Enabling the device

Pressing *ENABLE*, the screen will show like Fig. 5-6.

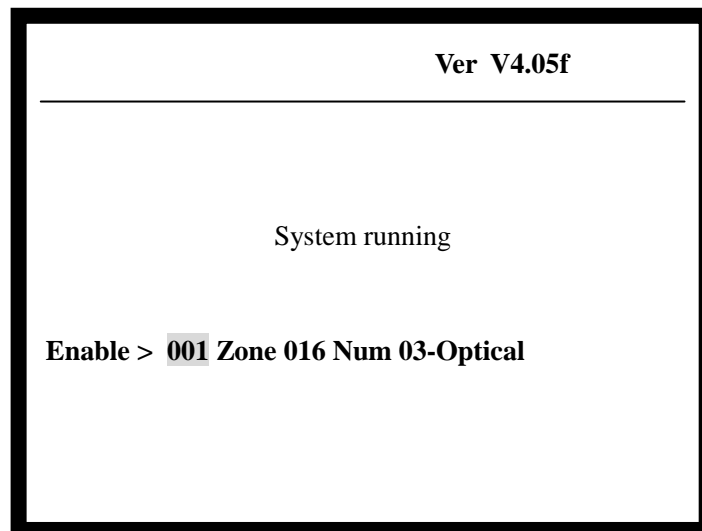

Fig. 5-6

Suppose user code of the optical smoke detector to be enabled is 001016. The operation of disablement should be as follows:

Step One: Input zone number “001” of the device.

Step Two: Press *TAB*, the highlight position moves to next input zone.

Step Three: Input device code “016”.

Step Four: Referring to “Appendix 2 Device Type List”, input the device type “03”.

Press *ENTER* to save. If the device has been enabled, the disablement information on the screen will disappear. Otherwise “Input Err” will be shown.

5.4.3 Browsing Disabled Information

Pressing *VIEW DISABLE*, you can browse disabled information of the device. Pages are turned by pressing Δ and ∇ . Disabled information can only be displayed by device mode. The window is shown in Fig. 5-7.

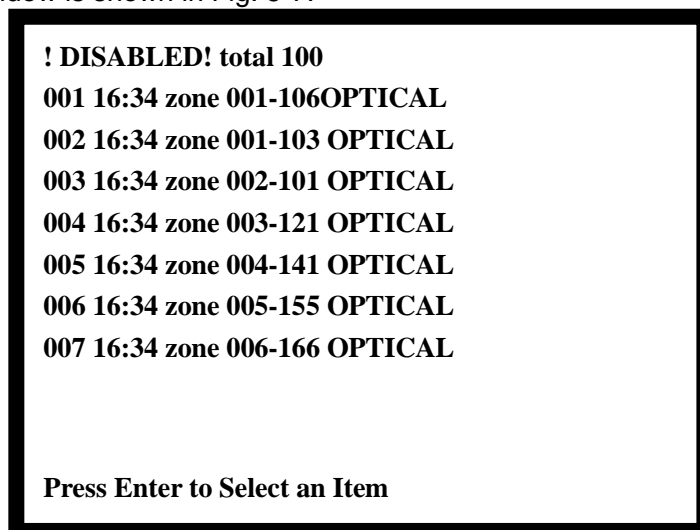
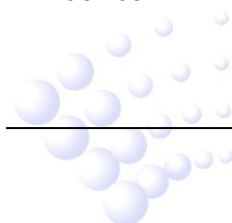

Fig. 5-7

Description of disabled screen:

- ✧ !DISABLED! total 100// Total number of the disabled information.
- ✧ 001 16:34 zone 001—106OPTICAL// Zone, device address and type of disabled device.
- ✧ 002 16:34 zone 001—103 OPTICAL// Zone, device address and type of disabled device.
- ✧ 003 16:34 zone 002-101 OPTICAL// Zone, device address and type of disabled device.
- ✧ 004 16:34 zone 003-121 OPTICAL// Zone, device address and type of disabled device.



5.5 Manual Start and Stop of Loop Devices

When fire alarm is confirmed, you can manually start extinguishing equipment in short time.

5.5.1 START/STOP Operation through Keypad

1. Starting a loop device

Pressing *START* can start a loop device, and the screen is shown in Fig. 5-8.

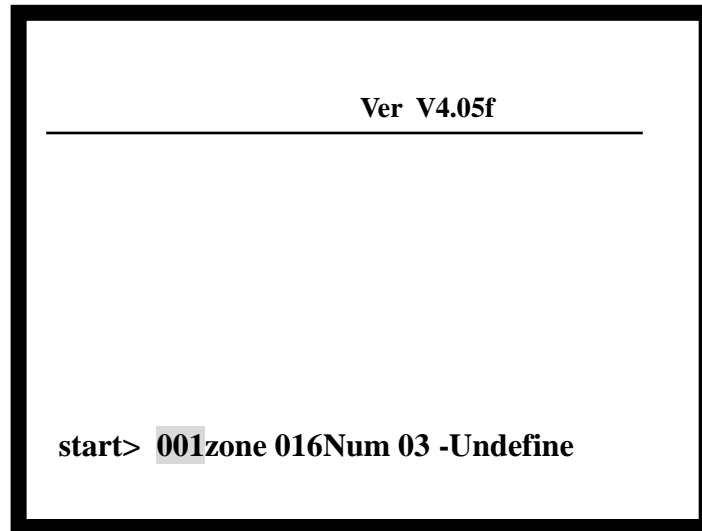

Fig. 5-8

The basic steps are as follows:

Step One: Input the user code of the device to start.

Step Two: Pressing *TAB*, device type is highlighted.

Step Three: Input the device type referring to “Appendix 2 Device Type List”.

Step Four: Pressing *ENTER*, the control panel gives start command.

After the device is started, *PLANT CONTROL* LED and action indicator on the ZCP will be lit.

2. Stopping a loop device

Pressing *STOP* can stop a loop device. The screen is shown in Fig. 5-9.

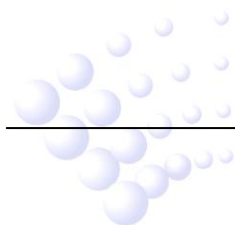

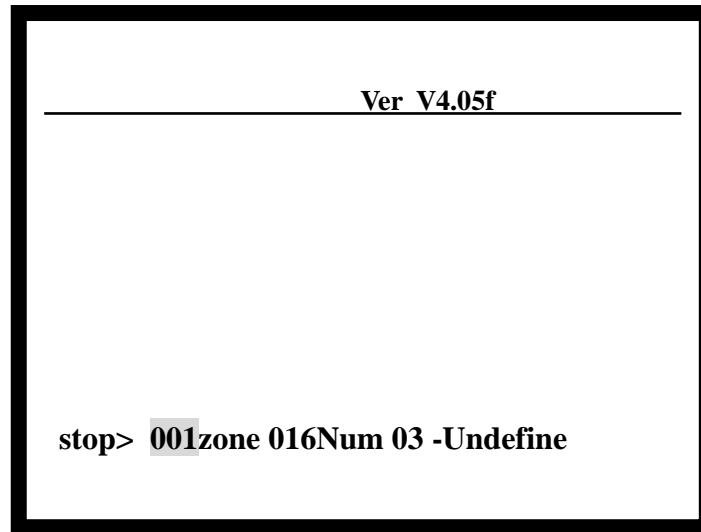

Fig. 5-9

Basic steps are as follows:

Step One: Input the user code of the device to stop.

Step Two: Pressing *TAB*, device type is highlighted.

Step Three: Input the device type referring to “Appendix 2 Device Type List”.

Step Four: Pressing *ENTER*, the control panel gives stop command.

After the device is stopped, *PLANT CONTROL* LED and action indicator on the ZCP will be off.

5.5.2 Operation of the Devices by ZCP

According to definition of the ZCP, press the key corresponding to the device, and input the password by system indication, you can start the device. Corresponding command LED of the key is lit. Press the key and input password again, you can stop the device, and the command LED turns off.

5.5.3 Browsing Started Devices

Pressing *VIEW PLANT*, you can browse the start information and change pages through Δ and ∇ . Start information is only shown by device mode, and its screen is like in Fig. 5-10.

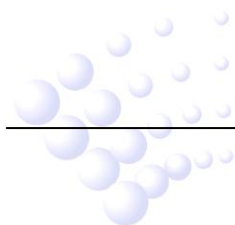

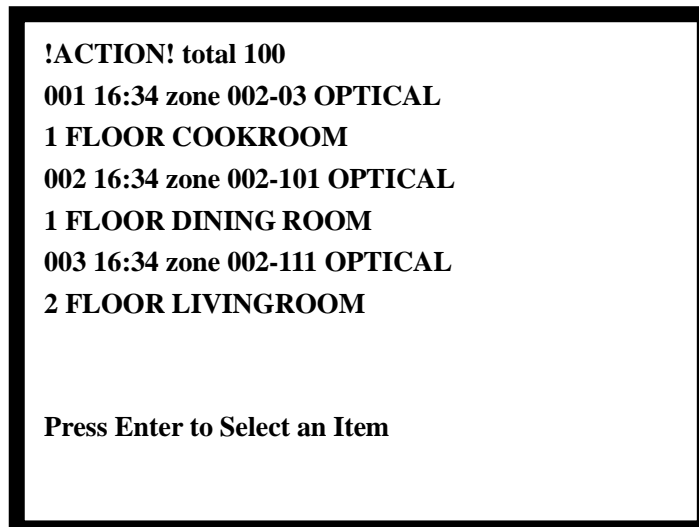

Fig. 5-10

Description of action information:

- ✧ ! ACTION! total 100// Total number of action information
- ✧ 001 16:34 zone 002—03 OPTICAL// Time, zone, device address and type of the action.
- ✧ 1 FLOOR COOKROOM// Zone definition (first 8 digits) and device, definition (last 32 digits).
- ✧ 002 16:34 zone 002-101 OPTICAL// Time, zone, device address and type of the action.
- ✧ 1 FLOOR DINING ROOM// Zone definition (first 8 digits) and device definition (last 32 digits).
- ✧ 003 16:34 zone 002-111 OPTICAL// Time, zone, device address and type of the action.
- ✧ 2 FLOOR LIVINGROOM// Zone definition (first 8 digits) and device definition (last 32 digits).

5.6 Resetting and Silencing of the System

First silencing the sound, then pressing *RESET* can turn off all the control modules, local outputs and all the detectors without changing the state of disabled devices. The LCD displays information of *RESET IN SYSTEM*, and all LEDs except for *POWER HEALTHY, AECURITY MODE* and *EXTINGUISHING SYSTEM PERMIT* will be turned off. The reset information will be written into running log. If there are still some fire alarm, fault and action information not acknowledged after pressing the *RESET* key, the FACP will remain sound indications. If all information has been acknowledged before pressing *RESET* key, the system returns to normal display state.

If the FACP alarms, pressing *MUTE*, you can silence the speaker. Pressing *MUTE*

again or if there are new alarms, the speaker will sound again.

5.7 Rules for Information Display

If there are more than one piece of information, they will be displayed in the following order: fire alarm, action, fault, start, disablement.

- ① The earliest fire alarm is displayed in priority. The latest action, fault, disabled information is displayed in priority.
- ② Fire alarm, fault, and disabled information can be displayed by both zone and loop display modes. Start and action can only be displayed by loop mode.
- ③ In any display mode, the system will return to displaying message of the highest priority if there is no operations within 20s (15s~30s).

5.8 Rules for Sound Indication

When there is fire alarm or fault, the speaker of the FACP will give sound indication.

- ✧ The FACP gives fire truck sound when fire alarm occurs.
- ✧ The FACP gives action sound when any device is activated.

Module action ——slow “tick” sound.

Gas extinguishing device action —— police car sound

Delay activation of devices by automatic C&E linkage—— quick “tick” sound.

- ✧ The FACP gives ambulance sound when fault occurs.

The control panel will give sound of higher priority if two types of information occur simultaneously. Pressing *MUTE* can stop the sound; pressing *MUTE* again, the control panel is still in mute state. It will sound by priority when new event appears.

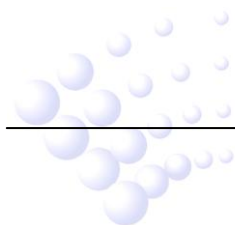

Chapter 6 Description of System Operation

6.1 Keypad

6.1.1 Functions

Most of the keys have double functions. Upper mark is a character and lower mark is command function that is only activated in monitoring state. Most function keys are controlled by password. The characters are only active after entering the menu.

6.1.2 Common Method of Data Input

There is a highlighted area indicating the current position and range of data input. Press a character key, the highlight and original characters disappear and input from that character. Move the highlight tab to any position for modification by pressing \triangle or ∇ .

Press *TAB*, the edited text is stored and the highlight moves to the next position and returns to the first after the last position. Wherever the cursor is, Press *ENTER* key, all the input data will be saved; press *ESC* to exit present editing state without saving.

6.1.3 Method of Browsing Information

Entering browsing state, press \triangle and ∇ to scroll for information.

Press *ENTER*, the top piece of information becomes highlighted and the system enters information selection state. Press *TAB* and exit highlight state.

In selecting state, press \triangle and ∇ to select highlight tab.

Pressing *ENTER* can print the information or display details of the information. Pressing *ESC* will exit to the previous menu or normal operation screen.

6.1.4 Keypad Unlock and Lock

The FACP is defaulted as key-locked on start-up. A password needs to be input if you operate any of the function keys (except for *SELF TEST*, *MUTE*, *LOG*, *VIEW FIRE*, *VIEW FAULT*, *VIEW DISABLE* and *VIEW PLANT*) (refer to Fig. 6-1). Input correct password and press *ENTER* to continue operation. After one minute without operation, the keys are automatically locked.

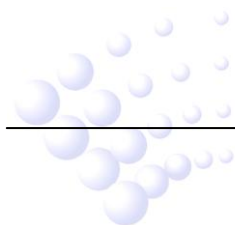

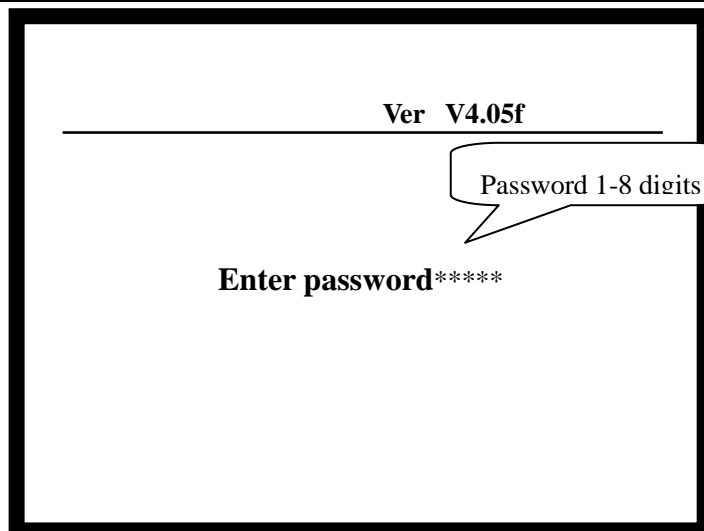

Fig. 6-1

6.2 User Operation Instruction

6.2.1 Changing time display

The clock is usually displayed in hour and minute (time mode) by the digitron on the panel. In normal monitoring state, pressing *TAB*, month and day (date mode) are displayed. Press *TAB* again or after a minute, time mode is displayed again.

6.2.2 Browsing history records

Pressing *LOG*, the system enters history information screen. Each piece of information includes the event time, 6-digit user number, event type and brief description of the event.

6-digit user number: If the event refers to an addressable device, the first 3 digits show zone number, the following 3 digits show the user code in this zone. If the information is about loop or bus, this number will be the loop or bus number.

Device type: It shows the device type for device information or the operation type for system operation.

Event description: Provides a brief description on the events, such as fire, start, action, fault, stop, disable, enable, action reset, set and operation etc.

Press *ENTER* key to highlight an information, press \triangle and ∇ to scroll up and down.

Press *ENTER* again to print the highlighted information, as shown in Fig. 6-2.

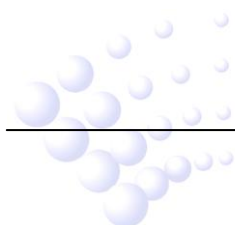

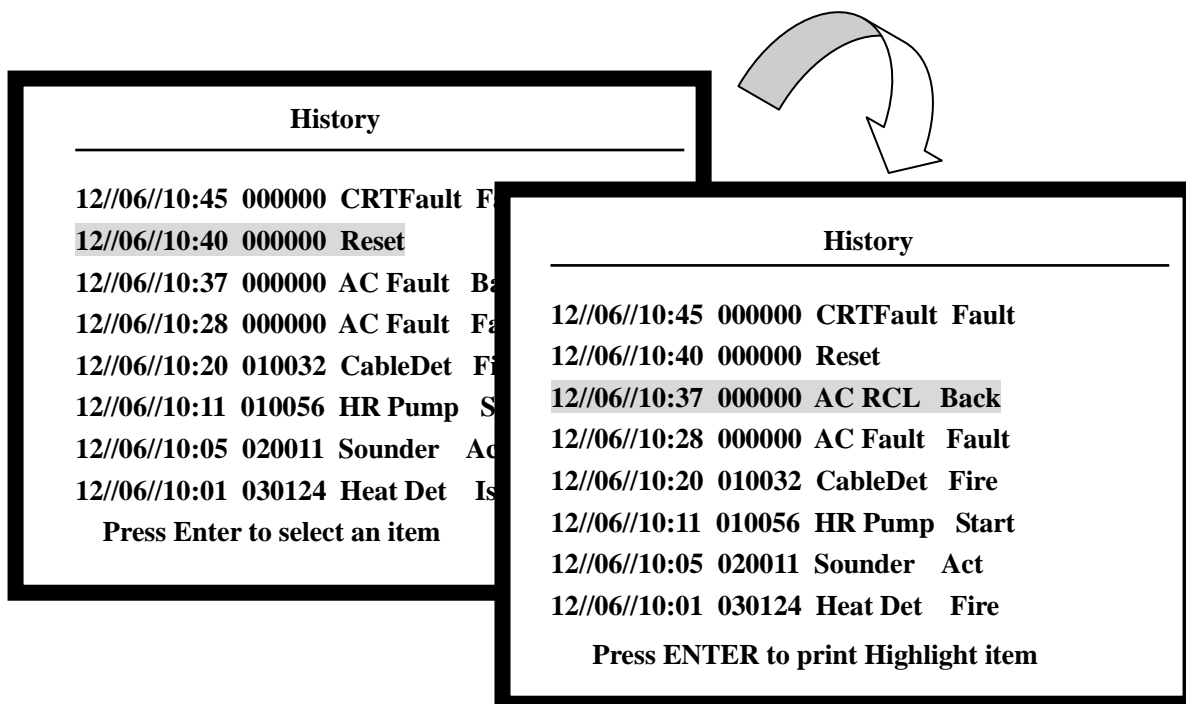

Fig. 6-2

6.3 Instructions for System Operator

6.3.1 Self Test

In normal monitoring state, pressing *SELF TEST*, you can check all the audio and visual components.

6.3.2 Printer Setting

The printer can be set to 3 modes. Pressing *PRINT* (needing password if the keypad is locked) in monitor state, the system is shown like Fig. 6-3.

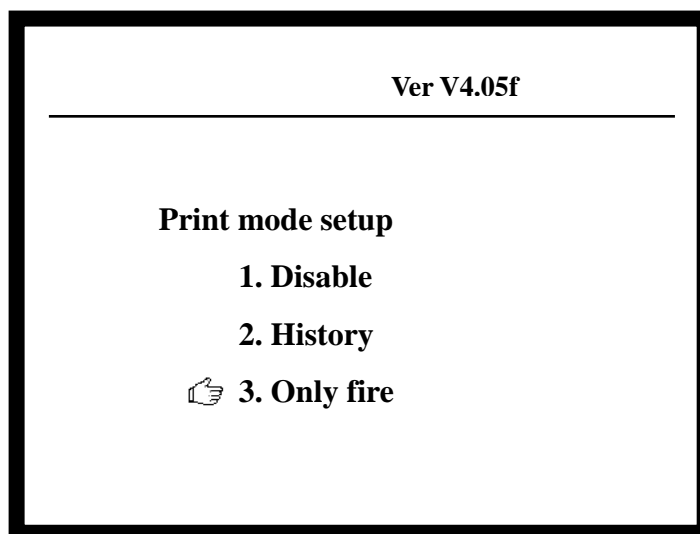

Fig. 6-3

Pressing \triangle and ∇ followed by *ENTER* can choose different printing modes:

1. Disable printing
2. Print history records while viewing them
3. Only print fire records

6.3.3 Security Mode

Pressing *SECURITY MODE* (needing password if the keypad is locked), the system will get into security mode setting, as shown in Fig. 6-4.

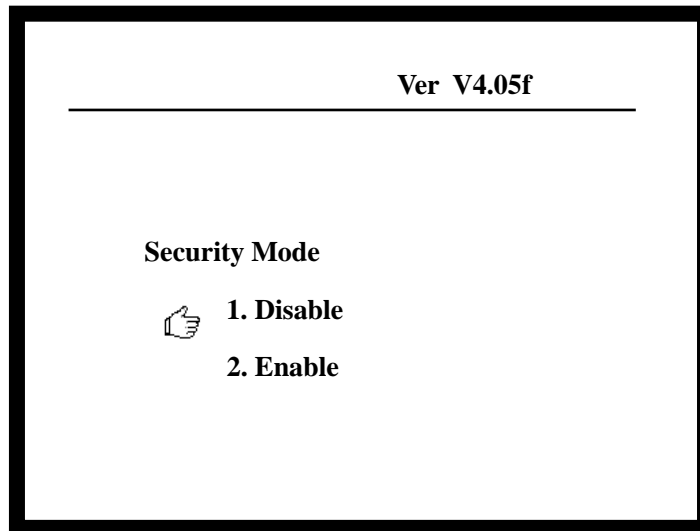
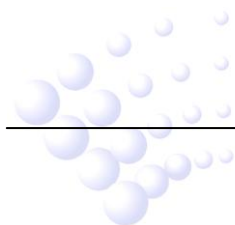

Fig. 6-4

The system can be set as security enable and disable mode under this screen. In enable mode, the security alarm function is enabled to monitor the protected area by security detectors, and *SECURITY MODE* LED illuminates.

6.3.4 Extinguishing Mode

Pressing *EXTINGUISHING MODE*, the system will enter gas extinguishing mode, as shown in Fig. 6-5.



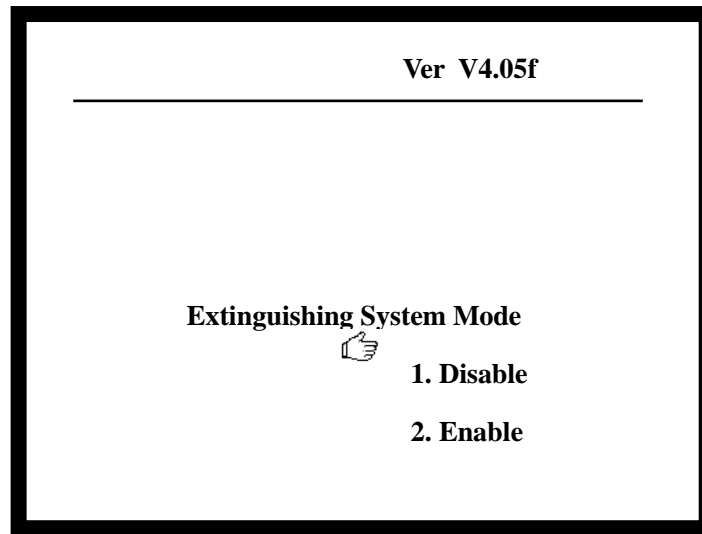

Fig. 6-5

Choosing one from the options can enable or disable gas release function. If it is in Enable mode, the *EXTINGUISHING SYSTEM PERMIT* indicator will be lit, the gas release device can be started manually or automatically.

6.3.5 Modification of System Time

In monitoring state, pressing *CLOCK* (needing password if the keypad is locked), the screen will display as in Fig. 6-6. Input the time in the highlight area and then press *TAB* to move the highlight to next position. Press *ENTER* to confirm.

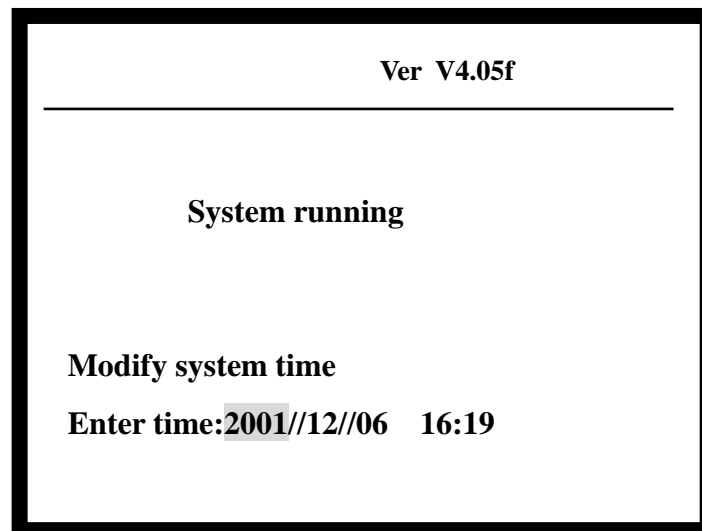
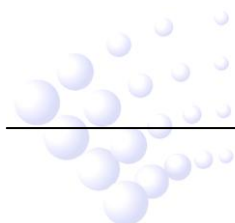

Fig. 6-6



6.4 Instructions for System Administrator

Pressing *SYSTEM* can enter system setup menu. This menu contains password setting and other functions for commissioning, including "Modify password", "Communicate setup", "Working state setup", "Fire display mode", "Zone browser", "C&E browser" and "Monitoring device". Refer to Fig. 6-7.

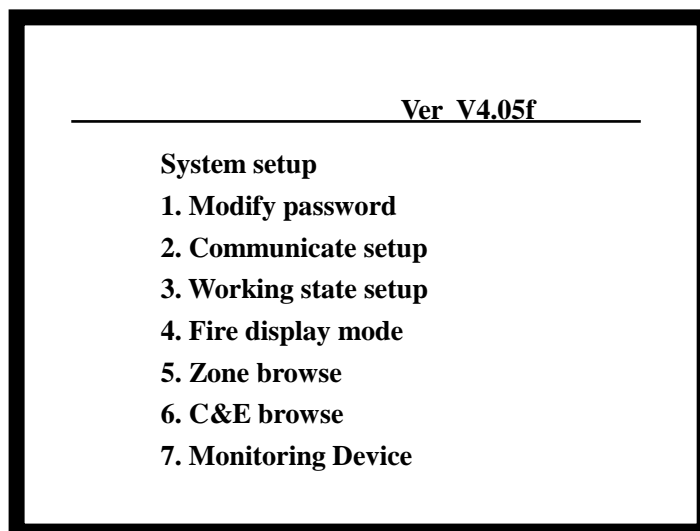

Fig. 6-7

6.4.1 Password Modification

1 Access level:

After the function keys (except for *SELF TEST*, *MUTE*, *LOG*, *VIEW FIRE*, *VIEW FAULT*, *VIEW DISABLE* and *VIEW PLANT*) are pressed, the system will display a screen requiring a password. Only after the correct password is input can a further operation be done.

User password: for printer setting, clock setting, security mode setting, start/stop, disable, enable and the operation on ZCP and FACP reset.

Gas extinguishing control password: for gas release enable control.

System password: Entering *SYSTEM* menu for setting of system state and data.

Higher-level password can substitute for lower-level password. System password must be entered for system operation. It becomes invalid on exit after certain operations are finished. Input password for other operations.

2 Password Modification

In system setup menu like Fig. 6-7, selecting the first item "Modify password", the screen will display the three levels of password, as shown in Fig. 6-8.

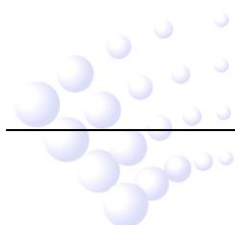

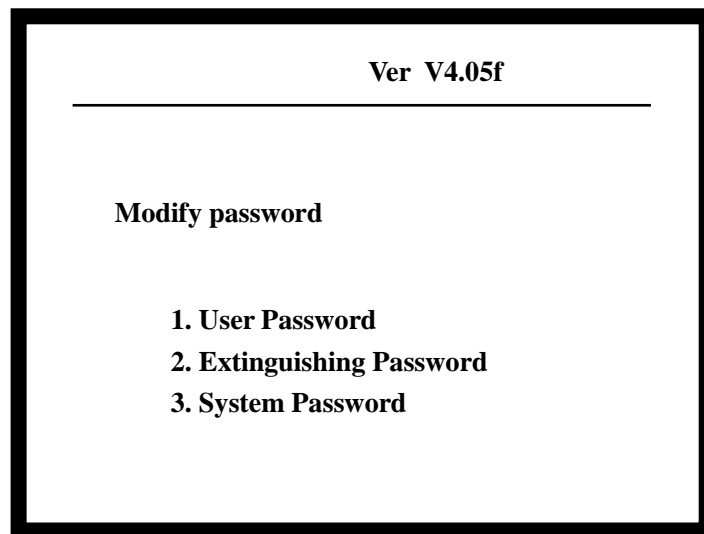

Fig. 6-8

Select the password to be modified, the screen will prompt to enter the old password. Input the password and press *ENTER*. If the password is correct, the screen will prompt to input the new password (Fig. 6-9). If the password is wrong, the system will exit current operation.

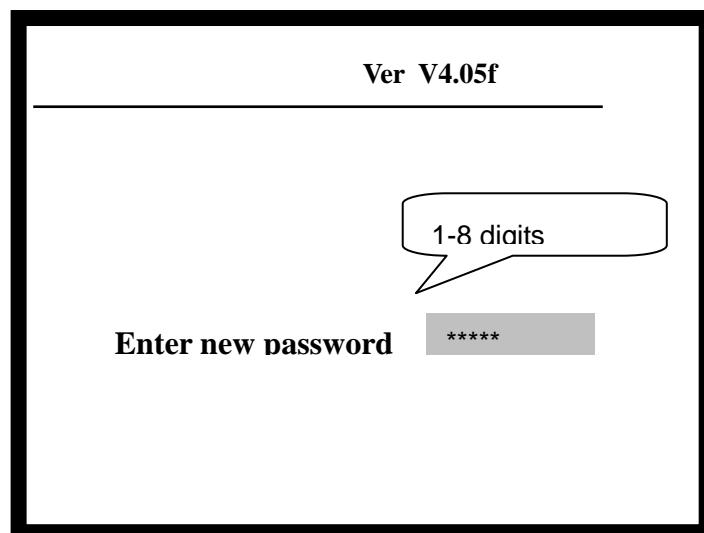
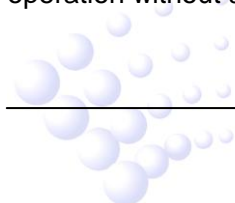

Fig. 6-9

Enter new password and press *ENTER*.

To prevent mistake, the FACP requires entering the new password again (Fig. 6-10).

If you typed the same password twice, the screen shows a brief password display with a long 'beep' sound and the system exits current operation, showing the new password has been entered successfully. If there are any mistakes, the system will exit current operation without any other prompt and the password will not be changed.



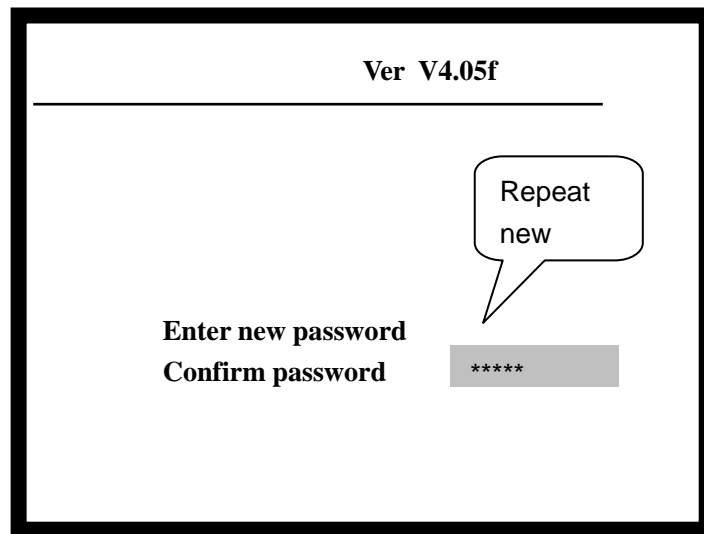

Fig. 6-10

6.4.2 Communication Setting

In system setup menu shown in Fig. 6-7, select the second item "Communicate setup", you can enter communication setting menu. Refer to Fig. 6-11.

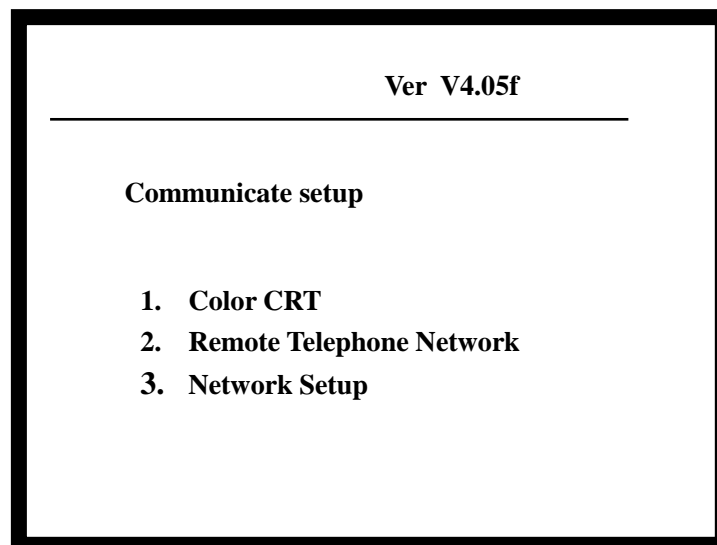

Fig. 6-11

Inputting 1 is to set CRT system.

Inputting 2 is to set remote telephone network system.

Inputting 3 is to set network system.

6.4.3 Working State Setup

In system setup menu in Fig. 6-7, select 3 "Working state setup" (Fig. 6-12):

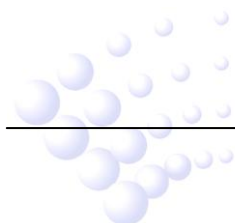

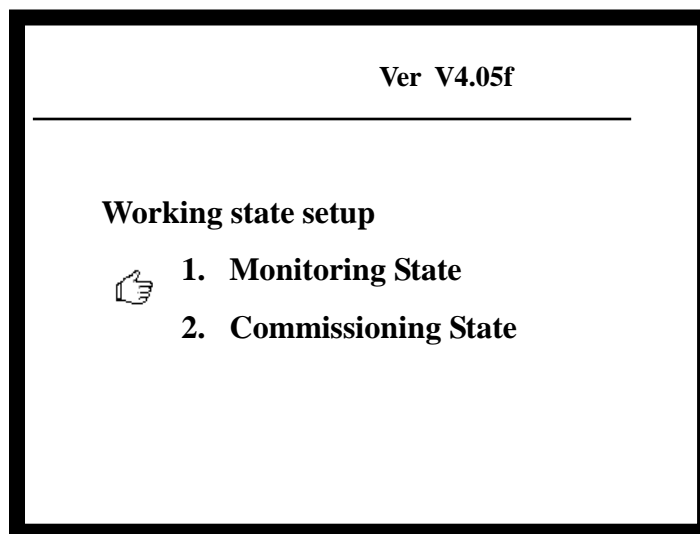

Fig. 6-12

Inputting 1, the system enters monitoring state.

Inputting 2, the system enters commissioning state.

6.4.4 Fire Display Mode

Select 4 "Fire display mode" under system setup menu (Fig. 6-7), the screen shows as in Fig. 6-13.

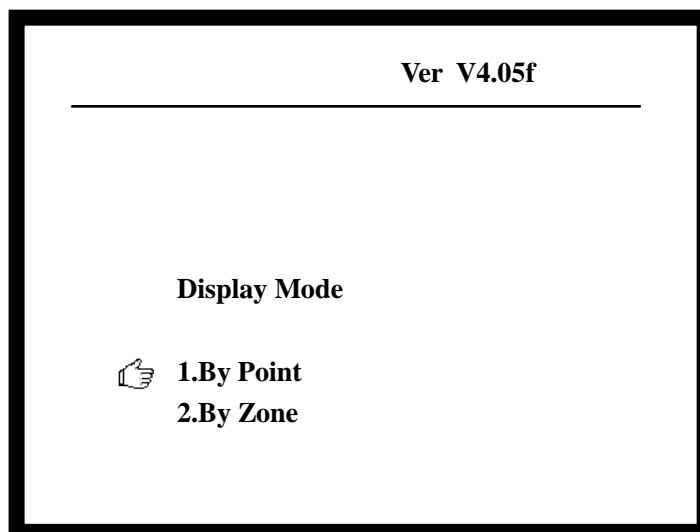

Fig. 6-13

Inputting 1, fire information will be displayed by device.

Inputting 2, fire information will be displayed by zone.

6.4.5 Zone Browse

Refer to section 4.6.3.

6.4.6 C&E Equation Browse

Refer to section 4.7.

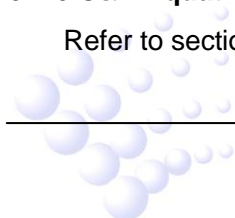

6.4.7 Browsing supervisory data of addressable devices

In the system setup menu as shown in Fig. 6-7, choose item 7 “Monitoring Device”, enter setting mode of fire display, as shown in Fig. 6-14.

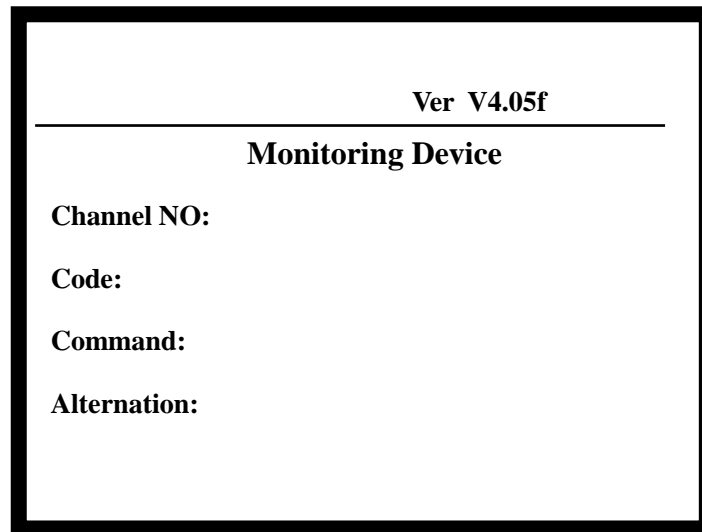

Fig. 6-14

Input loop number (Channel NO), code, command, intervals between two commands (Alternation).

In the Item of “Command” of the above screen, inputting different number represents different command. Details are as follows:

- ✧ “0” represents “polling”: Display value in “450~650” is normal; display value in “900~1200” is fire alarm; display value in “0~120” is fault.
- ✧ “1” represents “register”: If display value is 720, it is normal.
- ✧ “2” represents “viewing dynamic data”: It can read data of detectors in real time. It monitors commissioning state of I-9105R Intelligent Beam Detector, if the return value is between “680~750”, it means the commission is successful.
- ✧ “3” represents “viewing static data”.
- ✧ “4” represents “immediate start of gas extinguishing devices”. If the command of “Turn on gas release 24V”, gas-extinguishing devices will be started at once. Please be cautious with this operation.
- ✧ “5” represents “delay start of gas extinguishing devices”. If the command of “Turn on gas release 24V”, gas-extinguishing devices will be started after a delay of 30s. Please be cautious with this operation.
- ✧ “6” represents the command of “Turn on gas release 24V”. Please be cautious with this operation.
- ✧ “7” represents “start ordinary module”, which will cause output of corresponding modules. Please be cautious with this operation.

Chapter 7 Commissioning Functions

The commission mode is set for system commissioning, including registering devices, loop card disablement and detector searching functions.

NOTE: Under commission mode, all the registering information will not be saved. When the FACP is restarted, the missing or damaged devices will not be reported. These functions are only for commissioning.

7.1 Getting into Commission Mode

Enter system setup menu (Fig. 6-7), select "3.Working state setup" (Fig.7-1):

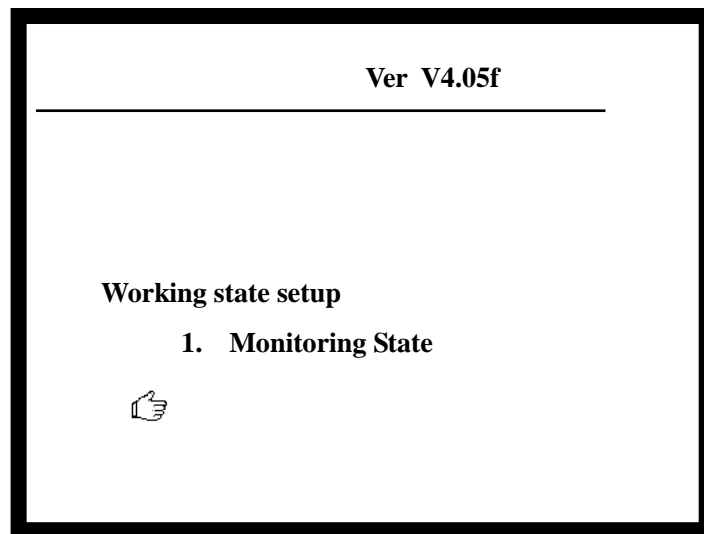

Fig. 7-1

Press " \triangle " and " ∇ ", select 2 "Commissioning State", confirm to enter commissioning state, the word "Installer" will appear on top of the screen. The screen shows as in Fig. 7-2.

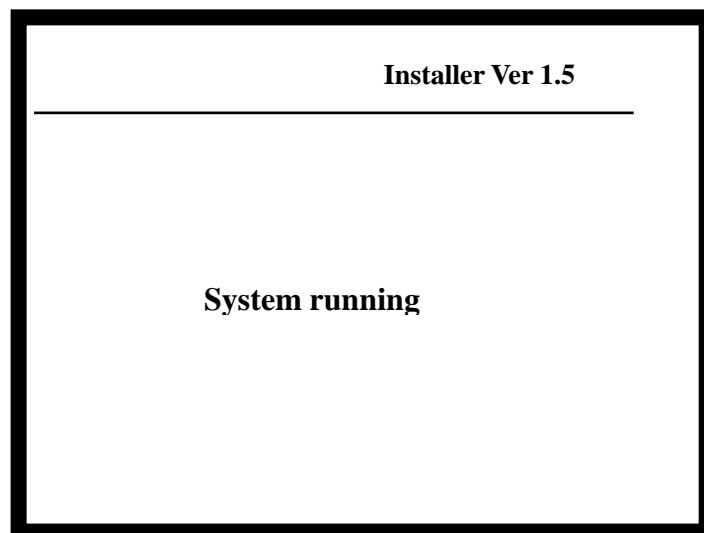
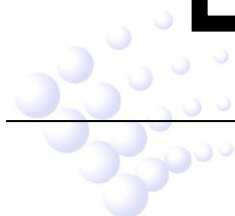

Fig. 7-2



Restart the control panel in this mode, it will register all devices again.

7.2 Exiting Commission Mode

Getting into the screen in Fig. 7-1 and choosing 1 "Monitoring State", the system will exit commission mode.

7.3 Registration at Any Time

In commission state, pressing *SELF TEST*, the FACP will automatically register all the devices again and display the information on the screen without affecting other information.

7.4 Loop Card Disablement

In commission mode, the loop cards can be disabled with the same method as detectors. The device type is 59. The user number is the loop number.

The disabled loop will stop bus output and stop the communication with the main board.

The "Enable" operation can cancel the disablement to the loop card.

7.5 Detector Searching

Under Commission Mode, the detectors can be forced into alarming state by keypad operation. It will be easy to find the location of a specified detector and test the transmission function of communication part.

The operation is the same as starting a module.

7.6 Protection of C&E Equations

There is a three-foot setting pin on the main board, putting its jumper at LEWR end when setting up, modifying or deleting a cause and effect equation. After system commission, you must put it at LDWRProtect end to protect the C&E equations.

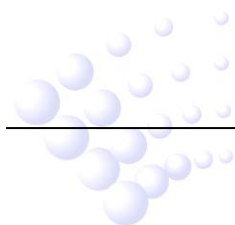

Chapter 8 Troubleshooting and Regular Checks

8.1 General Fault Treatment

Table 1

No.	Fault	Reason	Solution
1	No display or abnormal display	<ol style="list-style-type: none"> 1. Abnormal power supply. 2. The connection with the display board is loose. 	<ol style="list-style-type: none"> 1. Check +24 power supply. 2. Check the display connection cable
2	"AC Fault" is displayed when powered up	<ol style="list-style-type: none"> 1. No AC power supply. 2. AC fuse blown 	<ol style="list-style-type: none"> 1. Check mains supply 2. Change the fuse (refer to the label for specification)
3	"Battery Fault" is displayed when powered up	<ol style="list-style-type: none"> 1. The fuse is blown. 2. Loose connection. 3. The batteries are deficient in voltage or damaged. 	<ol style="list-style-type: none"> 1. Change the fuse (refer to the label for specification) 2. Open the cover of the power box and check relative connection parts. 3. Power up with AC power supply of over 8 hours, if the fault still exists, replace the batteries.
4	The loop cards can't be registered correctly.	<ol style="list-style-type: none"> 1. The loop cards are not inserted correctly. 2. The addresses of loop cards are wrongly set. 	<ol style="list-style-type: none"> 1. Check and insert correctly. 2. Check addresses of the loop cards.
5	The display panel can't be registered	The communication cable is not connected correctly	Check the cables for the display panel
6	Not printing	<ol style="list-style-type: none"> 1. Print mode isn't set. 2. Printer cable is not connected well. 3. Printer is broken. 	<ol style="list-style-type: none"> 1. Set the print mode. 2. Check and connect it well. 3. Replace the printer.
7	When pressing a key on zone indication panel, it doesn't respond.	<ol style="list-style-type: none"> 1. Manual disable mode 2. The cable of the zone indication panel is not connected well. 	<ol style="list-style-type: none"> 1. Set manual enable mode. 2. Check the cable and connect it well.
8	Device fault	<ol style="list-style-type: none"> 1. The cable is broken. 2. The device is damaged. 	<ol style="list-style-type: none"> 1. Check cable. 2. Replace the device.
9	Loop fault	The loop is shorted or broken.	Check the cable.
10	Clock fault, memory fault, loop fault etc.	<ol style="list-style-type: none"> 1. Environment Interference 2. Corresponding parts are ageing. 	<ol style="list-style-type: none"> 1. Check whether ground is properly connected. 2. Inform GST.

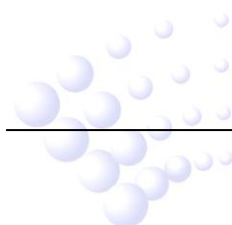

8.2 Regular Checks and Replacement

The device should be checked regularly:

1. The print paper should be replaced as required prior to running out.

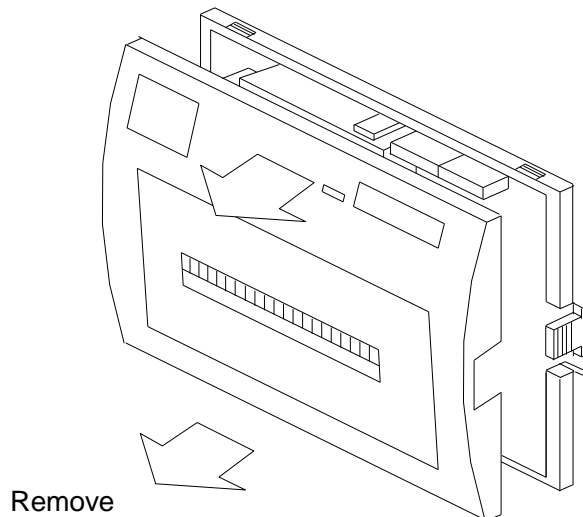
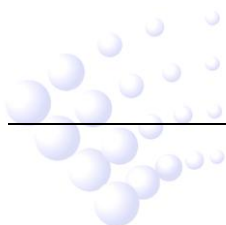

Fig. 8-1

- 1) Remove the printer front cover as shown in Fig.8-1.
- 2) Remove the whole printer from the panel. Please nip the movable tongues on the two sides with fingers according to Fig.8-2, remove the whole printer from the panel gently. **Note: Before removing the printer, make sure to turn off the power to the printer.**



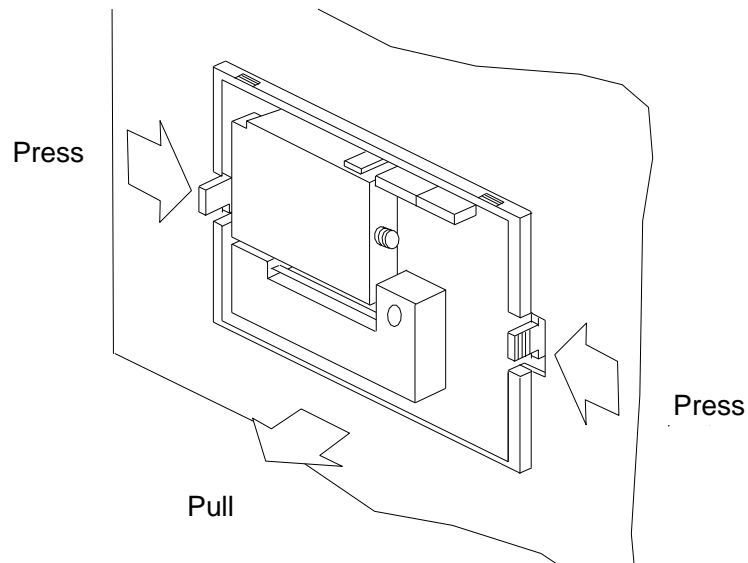

Fig.8-2

3) Remove the scroll spindle (Fig. 8-3).

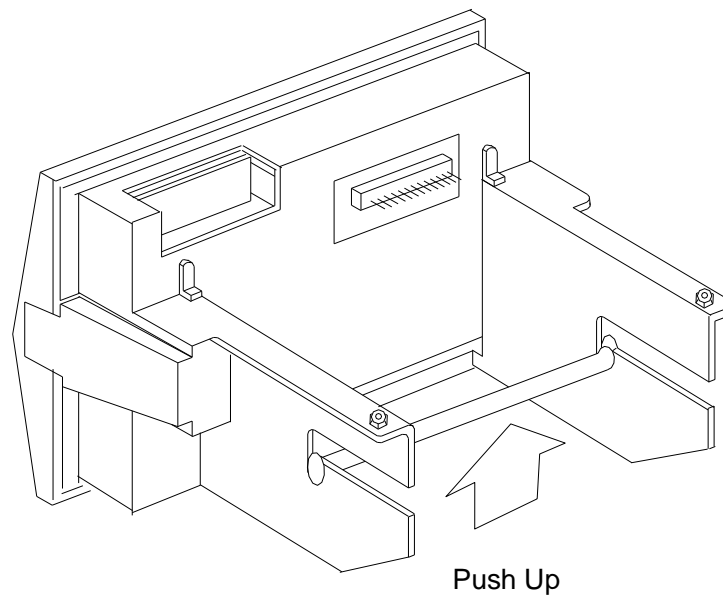
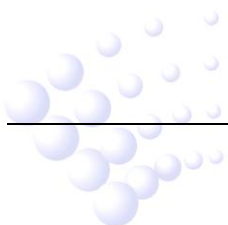

Fig. 8-3

4) Put the new scroll on the spindle. And press the scroll spindle into the groove of the printer as in Fig. 8-4. Make sure the scroll spindle is installed firmly.



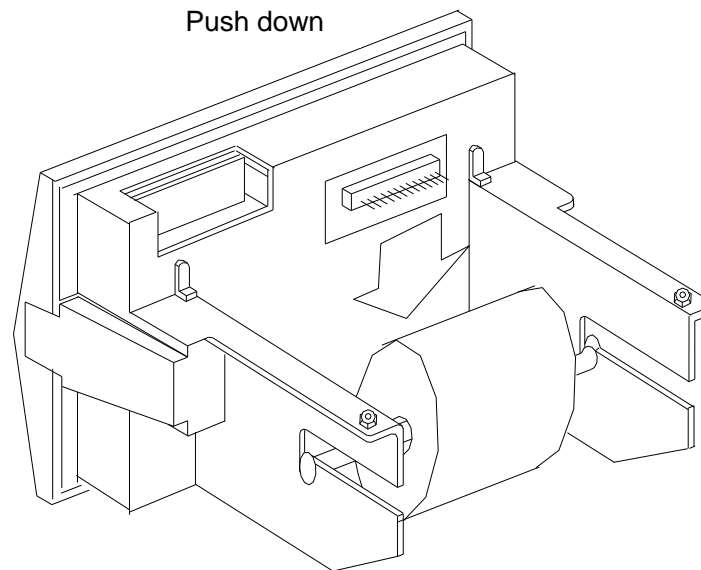

Fig. 8-4

5) Cut the end of the paper according to Fig.8-5.

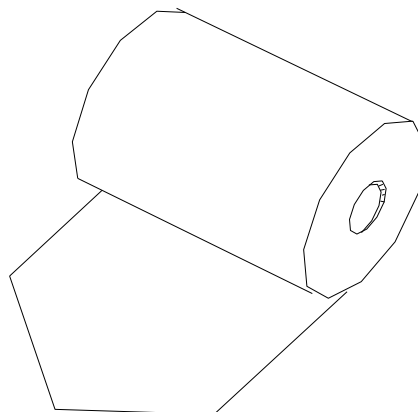

Fig. 8-5

6) Turn on the power of the printer. Press "SEL" key to turn off the "SEL" light. Then press LF to move the head. Feed the paper through by hand, the paper will enter slowly until it appears in front of the head. Feed through a suitable length of paper. Press LF or SEL again, or turn off the power. Replace the front cover of the printer. Feed the

paper through the paper slot.

7) Press the printer into the control panel gently.

8) If, according to engineering configuration, the back of the control panel display part is not covered by other structures, it is easier to take the paper from the back. Replacement of paper can be carried out according to steps 3), 4), 5) and 6).

2. The background light of the LCD has a life range. When any problem is found in its brightness, please inform the supplier.

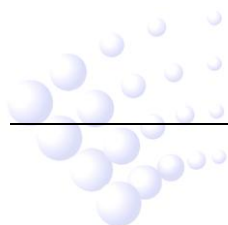

Chapter 9 Calculation of Battery Capacity

The equation for calculating battery capacity is as follows:

$$\text{Battery Capacity (Ah)} = 0.84 \times T + 0.03 \times N + 3.5$$

In which N is the number of detectors, and T is the time of operation in standby state.

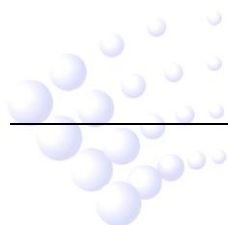

Appendix 1 Internal Connection Diagram

1. GST5000W Wall Mounted

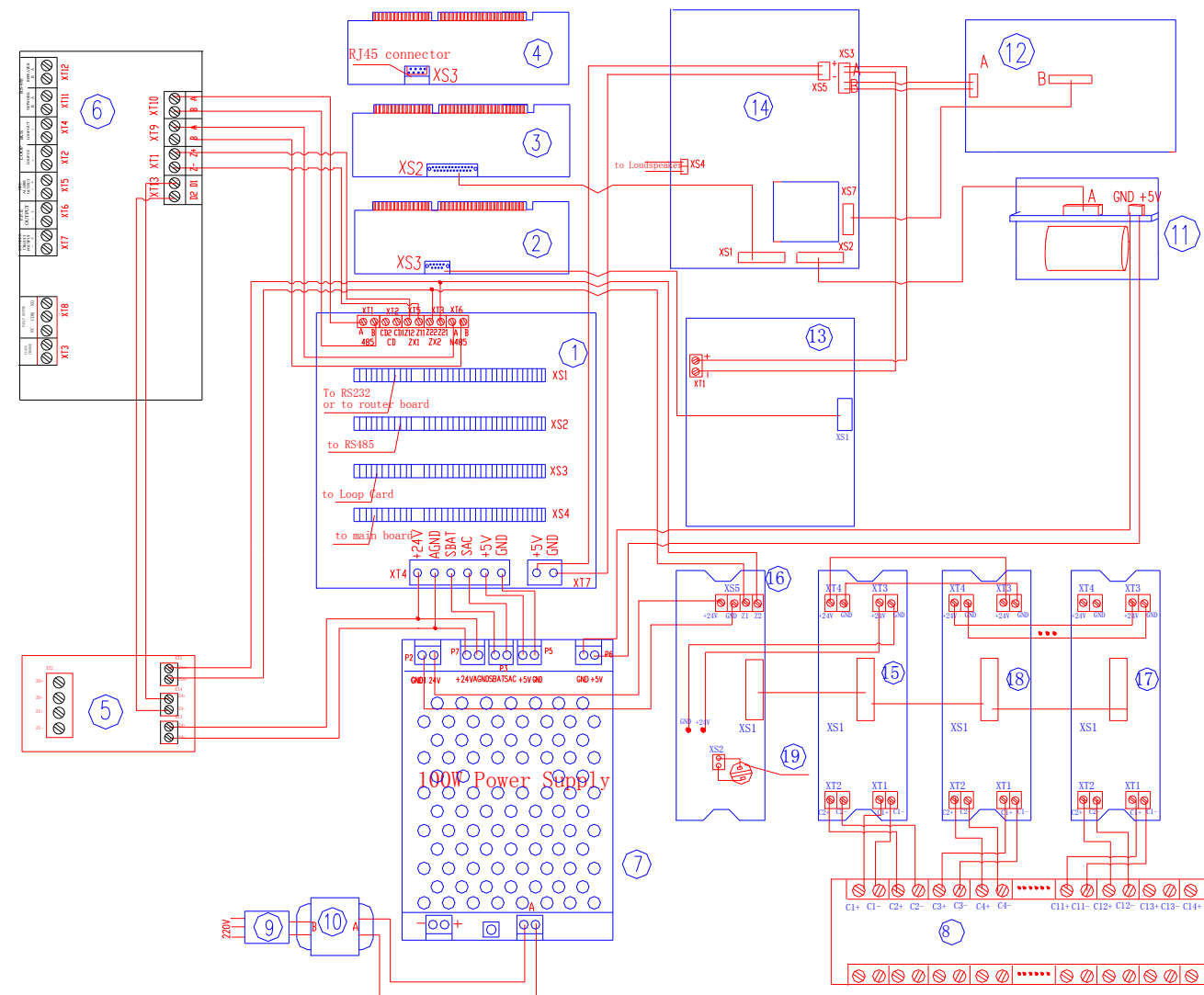

Number	Name	Number	Name	Number	Name	Number	Name
1	Motherboard	6	Loop interface board	11	Printer	16	Main board of fireman's control panel
2	Loop card	7	100W power	12	LCD	17	Slave board of the last fireman's control panel
3	Main board	8	Filter board	13	Zone indication and manual intervention panel	18	Slave board of fireman's control panel
4	232 communication card	9	Power filter	14	Switch board	19	Manual lock
5	Loop module	10	Transformer	15	Slave board of the first fireman's control panel	20	

2 GST5000 Rack type and console type

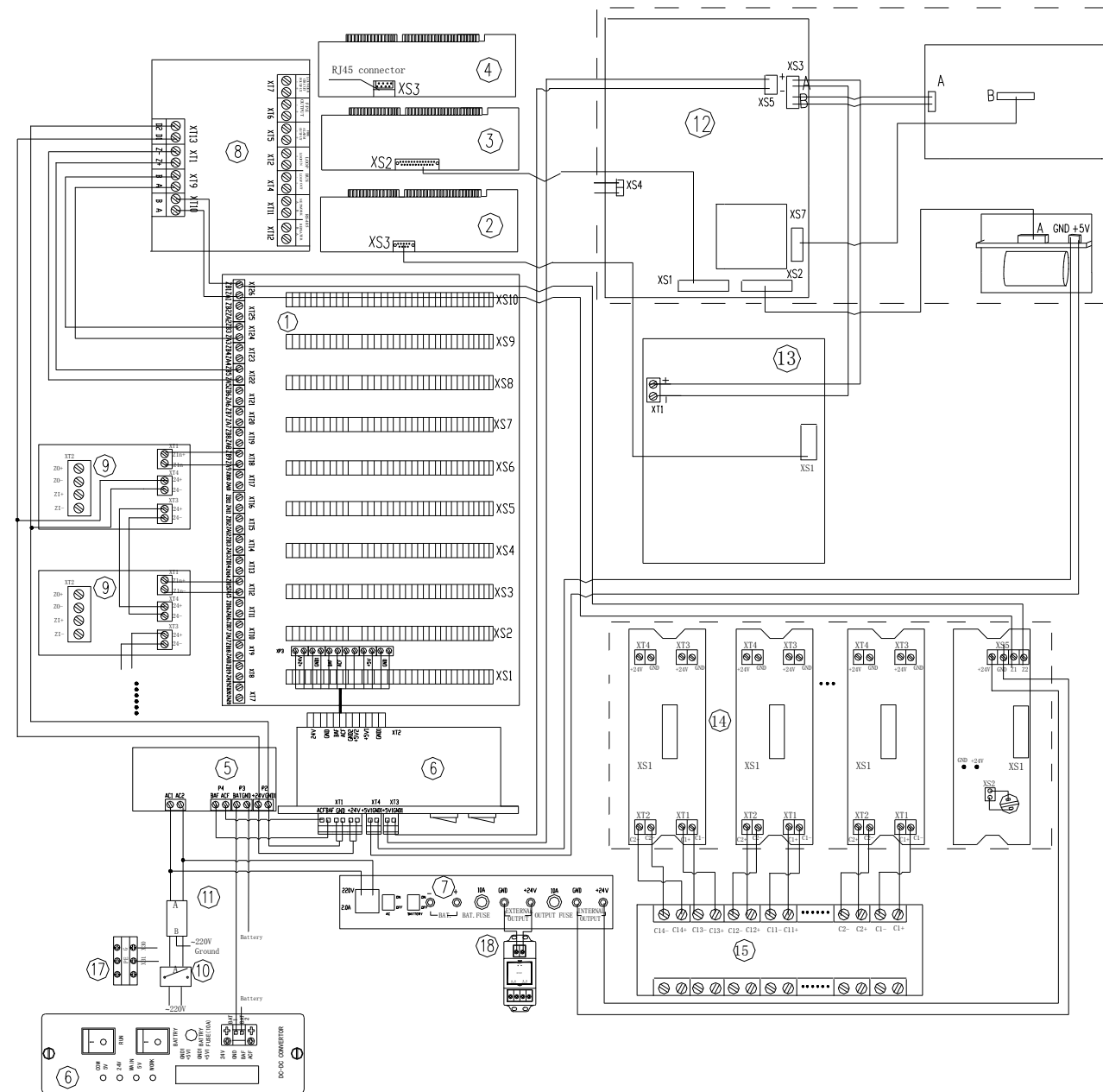

Number	Name	Number	Name	Number	Name	Number	Name
1	Motherboard	6	DC-DC converting module	11	Power filter	16	Power filter
2	Loop card	7	Intelligent PSU	12	Front Panel	17	Wiring board
3	Main board	8	Loop interface board	13	Zone indication and manual intervention panel	18	
4	232 communication board	9	Ring module	14	Fireman's Control Panel	19	
5	AC Power	10	Air switch	15	Filter board of fireman's control panel	20	

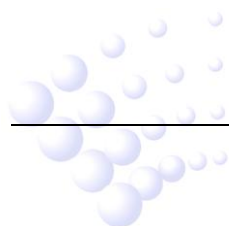

Appendix 2 Device Type List

Abbreviation	No.	Device type
Undefine	00	Undefined
ION	01	Ionization detector
R+F.Heat'	02	Rate-of-rise and fixed temperature detector
Optical	03	Photoelectrical smoke detector
Fix Temp	04	Fixed temperature detector
Gas Det	05	Gas detector
Beam Det	06	Infrared beam detector
FlameDet	07	Ultraviolet flame detector
CableDet	08	Cable heat detector
Heat Det	09	Analogue heat detector
Complex	10	Combination detector
MCP	11	Manual call point
VAModule	12	Voice alarm module
Sounder	13	Sounder strobe
FTModule	14	Fire telephone module
HR MCP	15	Hydrant manual call point
HR Pump	16	Hydrant pump
SPKR Pmp	17	Sprinkler pump
PS.SW	18	Stabilized pressure pump
Extract	19	Smoke exhauster
Presuriz	20	Blower
FreshAir	21	Fresh air
Damper	22	Fire damper
SM Vent	23	Smoke vent
Air Inlet	24	Air inlet
SolValve	25	Solenoid valve
SM CURT	26	Roller shutter door middle point
RSD Clse	27	Shutter screen door close point
FireDoor	28	Fire door
PS.DIFF	29	Pressure switch
Flow SW	30	Water flow indicator
Elevator	31	Elevator
AHU	32	Air handling unit
GENI	33	Diesel generator
Light.DB	34	Power for lightning
Power.DB	35	Power distribution
WTR.CURT	36	Solenoid valve for water curtain
Gas Dump	37	Gas start-up
GasAbort	38	Gas stop
Net unit	39	Net unit
Repeater	40	Repeater panel
Module	41	Flash-locks valve
DryPower	42	Dry powder fire extinguisher
FoamPump	43	Foam pump
FieldPSU	44	Power supply unit
EM Light	45	Emergency light
EscapeLT	46	Escape light
GasActiv	47	Gas activation
Security	48	Security module

ZoneValv	49	Zone valve
Cylinder	50	Cylinder
DelugePM	51	Deluge pump
Undefined	52	Undefined
Stop Mod	53	Device stop
Silence	54	Mute key
SounderA	55	Fire alarm sounder
SounderF	56	Fault sounder
Loop SW	57	Loop switch
CRT Fault	58	CRT Fault
Loop	59	Loop
PSU.Bat	60	Battery
PSU.AC	61	AC power
Lock	62	Multi-wire lock
PART	63	Part of devices
ZoneDir	64	Zone direction
F.P.E	65	Fire protection equipment
All evac	66	Evacuation
Ground.f	67	Ground fault

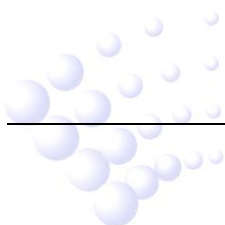

Appendix 3 Operation Menu

Menu

_____	MUTE To mute the speaker
_____	RESET To reset the system [password required]
_____	TAB To change time display mode
_____	ESC To the previous menu
_____	△ and ▽ For changing pages
_____	ENTER: For confirmation
_____	VIEW FIRE: Viewing fire information
_____	VIEW FAULT: Viewing fault information
_____	VIEW DISABLE Viewing disablement information
_____	VIEW PLANT Viewing action information
_____	SELF TEST For self-test [password required]
_____	DISABLE Isolating a device [password required]
_____	START To start a device [password required]
_____	BROWSE Viewing registration information [password required]
_____	CLOCK Modifying the system time [password required]
_____	ENABLE To de-disable the disabled device [password required]
_____	STOP To stop a started device [password required]
_____	LOG Browsing history record
_____	SECURITY MODE To set security mode [password required]
_____	EXTINGUISHING MODE To set gas-release mode [password required]
_____	PRINT To set the printer [password required]
_____	SYSTEM System menu [password required]
_____	Modify password Modifying password
_____	Communicate setup Setting communication mode
_____	Working state setup Setting working mode
_____	Fire Display Mode Setting fire display mode
_____	Zone Browse Viewing zone information
_____	C&E Browse Viewing C&E equation
_____	Monitoring Device Viewing supervisory data of intelligent devices

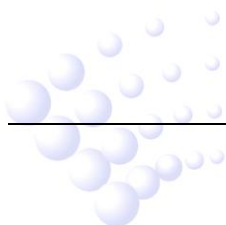



GST China

Gulf Security Technology Co., Ltd.

No. 80, Changjiang East Road, QETDZ, Qinhuangdao, Hebei,
P. R. China 066004

Tel: +86 (0) 335 8502528

Fax: +86 (0) 335 8508942

Email: sales.gst@fs.utc.com

www.gst.com.cn

GST UK

Global System Technology PLC

Lion Court, Staunton Harold Hall,
Melbourne Road, Ashby de la Zouch,
Leicestershire,

England LE65 1RT

Tel: +44 1283 225 478

Fax: +44 1283 220 690

Email: info@gst.uk.com

www.gst.uk.com

GST Dubai

Global System Technology PLC

PO Box 17998 Unit ZA04 JEBEL ALI Free Zone,
Dubai, UAE

Tel: +971 (0) 4 8833050

Fax: +971 (0) 4 8833053

Email: info@gst.uk.com

www.gst.uk.com