

# User manual

Number of instruction:  
LMI-64-04/09/13/ENG

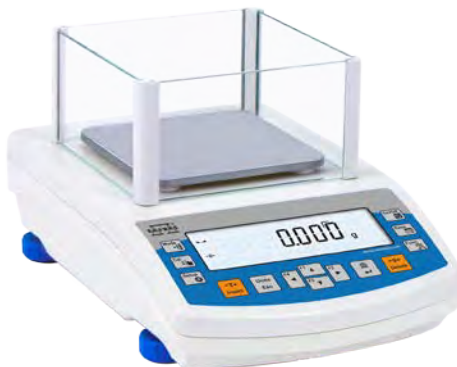

## LCD RADWAG BALANCES



### MANUFACTURER OF ELECTRONIC WEIGHING INSTRUMENTS

RADWAG 26 – 600 Radom, Bracka 28, POLAND  
Phone +048 48 38 48 800, fax +48 48 385 00 10  
Export department +0-48 48 366 80 06  
[www.radwag.com](http://www.radwag.com)

SEPTEMBER 2013

## SPIS TREŚCI

|  |    |
|--|----|
| 1. TECHNICAL DATA.....   | 6  |
| 1.1. Connection ports.....   | 9  |
| 2. BASIC INFORMATION.....  | 10 |
| 2.1. Intended use.....   | 10 |
| 2.2. Inappropriate use.....  | 10 |
| 2.3. Warranty.....   | 10 |
| 2.4. Monitoring the metrological parameters of the instrument..... | 11 |
| 2.5. Data included in this user manual.....                        | 11 |
| 2.6. Staff training.....   | 11 |
| 3. TRANSPORT AND STORAGE.....                                      | 11 |
| 3.1. Delivery check.....   | 11 |
| 3.2. Packaging.....  | 11 |
| 4. UNPACKING, ASSEMBLING AND START-UP.....                         | 12 |
| 4.1. Assembling and place of use.....                              | 12 |
| 4.2. Unpacking.....  | 13 |
| 4.3. Levelling.....  | 16 |
| 4.4. Cleaning.....   | 16 |
| 4.5. Plugging to mains.....  | 17 |
| 5. BASIC FUNCTIONS.....  | 17 |
| 6. KEYBOARD.....   | 19 |
| 7. START-UP.....   | 20 |
| 7.1. Connecting peripheral devices.....                            | 20 |
| 7.2. Balance temperature stabilisation period.....                 | 20 |
| 8. USER MENU.....  | 21 |
| 8.1. Moving through user menu.....                                 | 21 |
| 9. LOGGING IN.....   | 24 |
| 10. WEIGHING.....  | 26 |
| 10.1. Required weighing procedures.....                            | 26 |
| 10.2. Zeroing.....   | 28 |
| 10.3. Taring.....  | 28 |
| 10.4. Settings for mode <WEIGHING>.....                            | 30 |
| Setting level of filtering.....                                    | 30 |
| Value release.....   | 31 |
| Autozero function.....   | 32 |
| Displaying the last digit.....                                     | 32 |
| Balance ambient conditions.....                                    | 33 |
| 10.5. Printing mode.....   | 33 |
| 10.6. Temporary measuring unit.....                                | 35 |
| 10.7. Start-up measuring unit.....                                 | 35 |
| 10.8. Availability of measuring units.....                         | 36 |
| 10.9. User unit.....   | 37 |
| 10.10. Information.....  | 38 |
| 10.11. Non-standard information.....                               | 39 |
| 10.12. F button shortcuts.....                                     | 40 |
| 11. OTHER PARAMETERS.....  | 42 |
| 11.1. Available menu languages.....                                | 42 |

|  |    |
|--|----|
| 11.2. Access levels .....  | 42 |
| 11.3. 'Beep' sound – reaction on pressing function button .....                      | 42 |
| 11.4. Backlight and adjusting display brightness .....                               | 43 |
| 11.5. Date .....   | 43 |
| 11.6. Time .....   | 43 |
| 11.7. Date format .....  | 43 |
| 11.8. Time format .....  | 44 |
| 11.9. GLP autotest .....   | 44 |
| 12. INFORMATION ABOUT THE BALANCE .....  | 46 |
| 13. BALANCE ADJUSTMENT .....   | 47 |
| 13.1. Internal adjustment .....  | 48 |
| 13.2. Menu adjustment settings .....   | 50 |
| 13.3. Manual adjustment .....  | 52 |
| Internal adjustments .....   | 52 |
| User adjustment .....  | 53 |
| 13.4. Adjustment report printout .....   | 54 |
| 14. DETERMINING CONTENT OF A PRINTOUT .....  | 55 |
| 14.1. Adjustment report .....  | 55 |
| 14.2. Header printout .....  | 57 |
| 14.3. Measurement result printout – GLP PRINTOUT .....                               | 59 |
| 14.4. Footer printout .....  | 61 |
| 14.5. Non-standard printouts .....   | 63 |
| Inserting texts .....  | 63 |
| 14.6. Variables .....  | 66 |
| 15. DATABASE .....   | 67 |
| 15.1. Users .....  | 67 |
| 15.2. Products .....   | 70 |
| 15.3. Tares .....  | 71 |
| 15.4. Weighments .....   | 72 |
| 15.5. ALIBI .....  | 75 |
| 16. EXPORT AND IMPORT OF DATABASE .....  | 77 |
| 16.1. Export database .....  | 78 |
| 16.2. Import database .....  | 79 |
| 16.3. Measurement data print-out .....   | 79 |
| 17. BALANCE WORKING MODES .....  | 81 |
| 17.1. Setup for availability of working modes .....                                  | 82 |
| 17.2. Counting parts of the same mass .....  | 83 |
| Setup for mode COUNTING PIECES .....   | 84 |
| Setting the reference mass by determining from the sample of known<br>quantity ..... | 85 |
| Setting the reference mass by entering its mass .....                                | 87 |
| Returning to the weighing mode .....   | 88 |
| 17.3. Checkweighing .....  | 89 |
| Declaration of mass thresholds .....   | 90 |
| 17.4. Dosing .....   | 92 |
| Setting a target weight by entering values .....                                     | 93 |
| Returning to the weighing mode .....   | 95 |
| 17.5. Deviations % against the mass of the standard .....                            | 95 |

|  |     |
|--|-----|
| Setup for reference mass determined by weighing.....                           | 96  |
| Setup for reference mass by typing its mass.....                               | 97  |
| Returning to the weighing mode.....  | 98  |
| 17.6. Animal weighing.....   | 98  |
| Additional setting for animal weighing mode.....                               | 98  |
| Method of operation to manually start the process.....                         | 100 |
| Method of operation to automatically start the process.....                    | 102 |
| 17.7. Density of solids.....   | 103 |
| Density determination of solids.....   | 106 |
| 17.8. Density of liquid.....   | 109 |
| 17.8.1. Density of liquids determination.....                                  | 109 |
| 17.9. Statistics.....  | 112 |
| 17.9.1. Means of operation.....  | 113 |
| 17.9.2. Deleting statistics.....   | 116 |
| 17.9.3. Returning to the weighing mode.....                                    | 117 |
| 17.10. Totalising.....   | 118 |
| 17.10.1. Means of operation.....   | 119 |
| 17.10.2. Returning to the weighing mode.....                                   | 121 |
| 17.11. Peak hold.....  | 122 |
| 17.11.1. Means of operation.....   | 123 |
| Returning to the weighing mode.....  | 124 |
| 18. COMMUNICATION.....   | 125 |
| 18.1. RS 232 ports settings.....   | 125 |
| 18.2. WIFI port settings.....  | 126 |
| 19. PERIPHERALS.....   | 128 |
| 19.1. Computer.....  | 128 |
| 19.2. Printer.....   | 129 |
| 19.3. Bar code reader.....   | 129 |
| 19.4. Additional display.....  | 130 |
| 20. WORKING WITH EXTERNAL DEVICES SUCH AS PRINTER OR<br>COMPUTER.....          | 131 |
| 20.1. Cable pinout diagram.....  | 132 |
| 20.2. Format of data setting.....  | 133 |
| 20.3. Format of data sent on pressing of PRINT button.....                     | 133 |
| Format of data sent as response for commands generated from a<br>computer..... | 133 |
| 21. COMMUNICATION PROTOCOL.....  | 135 |
| 21.1. List of commands.....  | 135 |
| 21.2. Responses format for commands sent from computer level.....              | 136 |
| 21.3. Commands description.....  | 136 |
| 22. ERROR MESSAGES.....  | 141 |
| 23. UNDER HOOK WEIGHING.....   | 143 |
| 24. ADDITIONAL EQUIPMENT.....  | 144 |
| 24.1. Anti-vibration table.....  | 144 |
| 24.2. Rack for under hook weighing.....  | 144 |
| 24.3. Density determination kit (for solids and liquids).....                  | 144 |
| 24.4. Additional display.....  | 144 |

## 1. TECHNICAL DATA

### Balance AS.R series:

|                     | <b>AS<br/>60/220.R2</b>                | <b>AS<br/>160.R2</b> | <b>AS<br/>220.R2</b> | <b>AS<br/>310.R2</b> |
|---------------------|--|----------------------|----------------------|----------------------|
| Max capacity        | 60/220g                                | 160g                 | 220g                 | 310g                 |
| Min capacity        | 1mg                                    | 10 mg                | 10 mg                | 10 mg                |
| Readability         | 0.01/0.1mg                             | 0.1mg                | 0.1mg                | 0.1mg                |
| Tare range          | -220g                                  | -160 g               | -220 g               | -310 g               |
| Pan size            | Φ 85 mm                                |                      |                      |                      |
| Sensitivity drift   | 1 ppm/°C in temperature +10 ° - +40 °C |                      |                      |                      |
| Working temperature | +10 ° - +40 °C                         |                      |                      |                      |
| Power supply        | 12 ÷ 16 V DC / 2.1 A                   |                      |                      |                      |

### Dimensions:

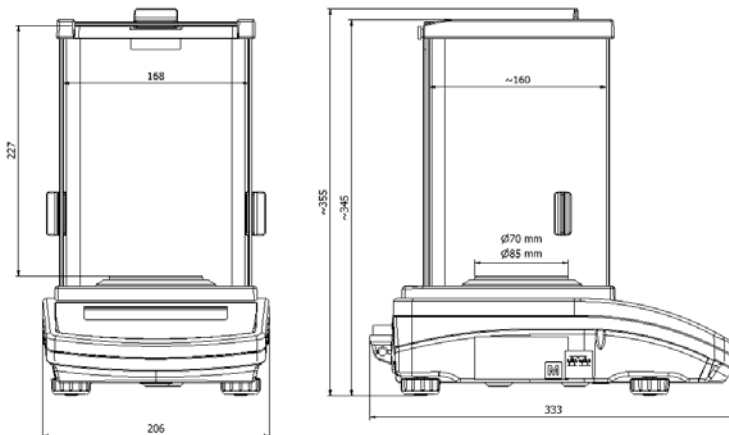

**Balance PS.R series with weighing pan 128 x 128 mm:**

| Type balance        | PS 200/2000.R2                        | PS 210.R2 | PS 360.R2 | PS 600.R2 | PS 750.R2 | PS 1000.R2 |
|---------------------|---------------------------------------|-----------|-----------|-----------|-----------|------------|
| Max capacity        | 200/2000g                             | 210g      | 360g      | 600g      | 750g      | 1000g      |
| Tare range          | -2000g                                | -210g     | -360g     | -600g     | -750g     | -1000g     |
| Min capacity        | 20mg                                  | 20mg      | 20mg      | 20mg      | 20mg      | 20mg       |
| Readability         | 1/10mg                                | 1mg       | 1mg       | 1mg       | 1mg       | 1mg        |
| Working temperature | +10°C - +40°C                         |           |           |           |           |            |
| Power supply        | 12 ÷ 16 V DC / 2,1 A                  |           |           |           |           |            |
| Sensitivity drift   | 2 ppm/°C in temperature +10°C -+ 40°C |           |           |           |           |            |
| Pan size            | 128x128 mm                            |           |           |           |           |            |

**Dimensions:**

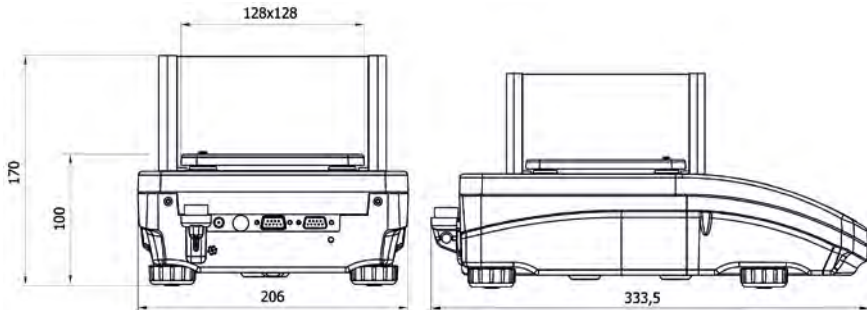

**Balance PS.R series with weighing pan 195 x 195 mm:**

| Type balance        | <b>PS<br/>1200.R2</b>                 | <b>PS<br/>2100.R2</b> | <b>PS<br/>3500.R2</b> | <b>PS<br/>4500.R2</b> | <b>PS<br/>6000.R2</b> |
|---------------------|---------------------------------------|-----------------------|-----------------------|-----------------------|-----------------------|
| Max capacity        | 1200g                                 | 2100g                 | 3500g                 | 4500g                 | 6000g                 |
| Tare range          | -1200g                                | -2100g                | -3500g                | -4500g                | -6000g                |
| Min capacity        | 500mg                                 | 500mg                 | 500mg                 | 500mg                 | 500mg                 |
| Readability         | 10mg                                  | 10mg                  | 10mg                  | 10mg                  | 10mg                  |
| Working temperature | +10°C - +40°C                         |                       |                       |                       |                       |
| Power supply        | 12 ÷ 16 V DC / 2,1 A                  |                       |                       |                       |                       |
| Sensitivity drift   | 2 ppm/°C in temperature +10°C - +40°C |                       |                       |                       |                       |
| Pan size            | 195x195mm                             |                       |                       |                       |                       |

**Dimensions:**

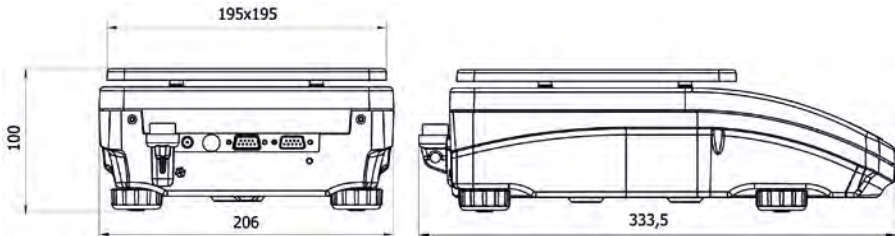



## Balance APP.R series:

|                     | <b>APP<br/>10.R2</b> | <b>APP<br/>35.R2</b> |
|---------------------|----------------------|----------------------|
| Max capacity        | 10 kg                | 35 kg                |
| Tare range          | -10 kg               | -35 kg               |
| Min capacity        | 2 g                  | 2 g                  |
| Readability         | 0.01 g               | 0.1 g                |
| Working temperature | +10 °C - +40 °C      |                      |
| Power supply        | 12 ÷ 16 V DC / 2,1 A |                      |

### 1.1. Connection ports

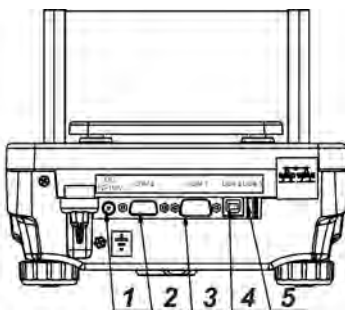

- 1 - power port
- 2 - COM 2 port (e.g. additional display)
- 3 - COM 1 port (e.g. printer)
- 4 - USB 2 port (e.g. computer)
- 5 - USB 1 port (e.g. computer keyboard)

## **2. BASIC INFORMATION**

### **2.1. Intended use**

The purchased balance serves to determine the weighing value of loads in laboratory environment. It is intended for application as a non-automatic weighing instrument only, i.e. the material to be weighed is manually and carefully placed in the centre of the weighing pan. Weighing result should be read only after stable reading has been obtained.

### **2.2. Inappropriate use**

Do not use the balance as a dynamic weighing instrument. Even if small quantities of weighed material are added or removed from the weighing pan of the instrument, the reading should be taken only after stabilisation of the measurement results. Do not place any magnetic materials on the weighing pan, as this can cause damage to the measuring system of the instrument.

Be sure to avoid impact shock and overloading the balance in excess of the prescribed maximum measuring range (max capacity), minus any possible tare weight that has been applied.

Never use the balance in an environment where explosion is possible. This balance has not been adjusted for operation in explosive areas.

There must not be any modification made to the balance.

### **2.3. Warranty**

Warranty is invalid for the following:

- non- observation of the guidelines of this user manual,
- use of the balance other than specified in this manual,
- alteration to or opening of the device,
- mechanical damage and damage caused by media, water, wear and tear,
- inappropriate assembling or defects of electric installation,
- overloading of the measuring instrument.

## **2.4. Monitoring the metrological parameters of the instrument**

Metrological characteristics of the balance require periodical inspection to be carried out by its user. Inspection frequency is dependent on ambient conditions in which the balance is used, types of performed processes and accepted quality management system in organisation.

## **2.5. Data included in this user manual**

Please read the user manual carefully before assembling and start-up, even if the user is experienced with this type of weighing instruments.

## **2.6. Staff training**

This balance should only be operated and maintained by personnel who is trained and experienced in using this type of balances.

# **3. TRANSPORT AND STORAGE**

## **3.1. Delivery check**

Please check the packaging immediately upon delivery and the device during unpacking for any visible signs of external damage.

## **3.2. Packaging**

Please retain all parts of the original packaging should the balance be transported in the future. Only the original packaging should be used for shipping the balance. Before packing, disconnect all attached cables and remove any loose/movable parts (weighing pan, anti-draft shield, etc.). Please place balance and its components in their original packaging, and protect them against damage during transport.

## 4. UNPACKING, ASSEMBLING AND START-UP

### 4.1. Assembling and place of use

- The balance should be stored and used in locations free of vibrations and shakes, free of air movement and dust,
- ambient air temperature should not exceed the range of:  $+10\text{ }^{\circ}\text{C} \div +40\text{ }^{\circ}\text{C}$ ,
- ambient relative humidity should not exceed 80%,
- during balance operation, ambient temperature in the weighing room should not change more than  $3\text{ }^{\circ}\text{C}$  within one hour,
- the balance should be located on a stable wall console desk or a stable working table which is not affected by vibrations and distant from heat sources,
- take special precaution when weighing magnetic objects, as part of the balance is a strong magnet. Should such loads be weighed, use under hook weighing option, which removes the weighed load from area influenced by the balance's magnet. For assembling the hook for under hook weighing option see the bottom section of balance's housing,
- in order to avoid the influence of static electricity on the measurement process, ground the balance's housing. The grounding bolt is located at the back of the balance's housing.

## 4.2. Unpacking

### Balance AS with weighing pan $\Phi$ 85 mm:

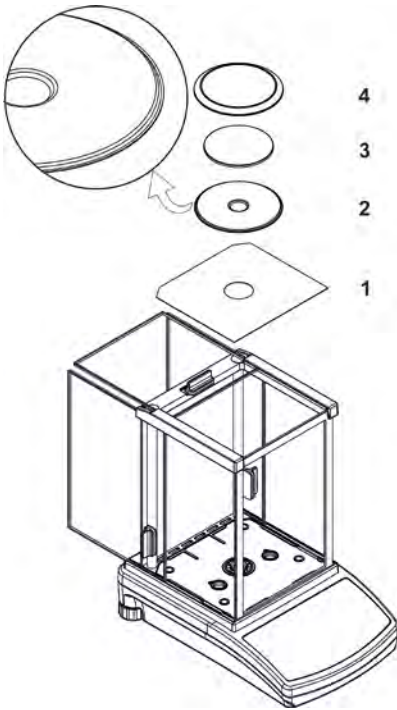

- open side doors of the weighing chamber,
- inside the weighing chamber place lower shield of the weighing chamber (1),
- put centering ring [framing facing downwards] (2),
- in the centre of centering ring assembly the weighing pan (3),
- put anti-draft shield in the chamber (4),
- close side doors of the weighing chamber,
- plug the balance to mains, pin of power adaptor should be connected to socket in the back of balance housing.

## Balance PS

Remove the adhesive tape. Carefully remove the balance from its packaging. Remove all the elements necessary for correct operation from the accessory box. Carefully remove the plastic and foil transport protective elements and gently place the balance in its intended place of use.

Assemble the weighing pan, and other elements according to below schema:

### Assembling a balance with reading interval 10mg:

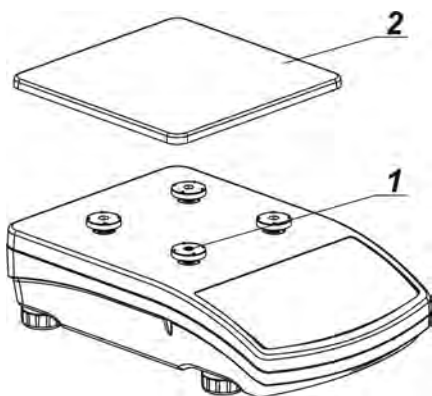

- remove the adhesive tape protecting the mass spring on one of the rubber bumpers (1),
- assemble the weighing pan (2) on the rubber bumpers (1),
- after assembling the balance components, check whether the weighing pan is firmly placed on the rubber bumpers.

### Assembling a balance with reading interval 1mg:

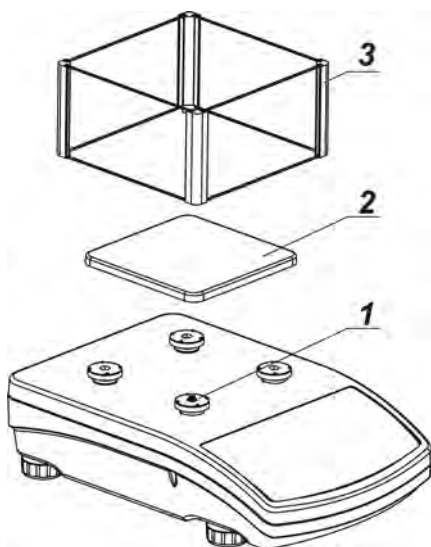

- remove the adhesive tape protecting the mass spring on one of the rubber bumpers (1),
- assemble the weighing pan (2) on the rubber bumpers (1),
- assemble the glass anti-draft shield (3)
- after assembling the balance components, check whether the weighing pan is firmly placed on the rubber bumpers.

## Balance APP

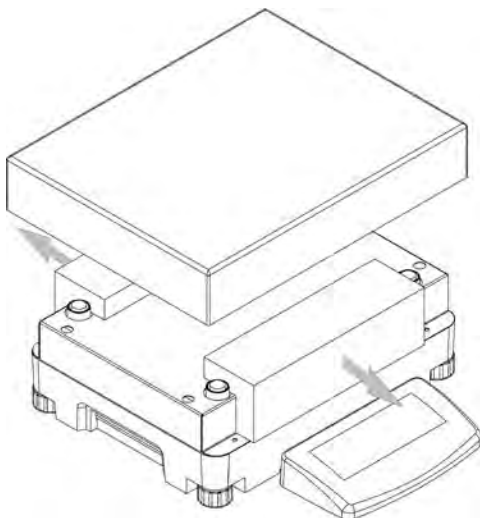

- Remove the weighing pan and remove transport protective elements as shown in the picture above (if these elements are attached).
- After the unpacking of the balance unscrew the bolt (1) which blocks the calibration mechanism.

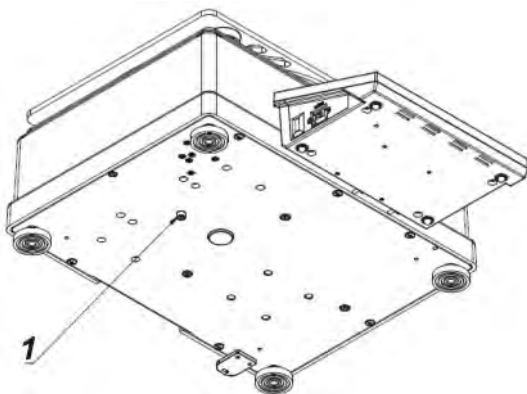

- Assemble the weighing pan.
- Make sure the weighing pan is placed properly on the shock absorbers: the weighing pan cannot touch the housing and should be stable.
- After removing the protective elements and placing the weighing pan, plug the indicator into the port which is on the back of the housing. Next, plug in all the additional devices. Only then can the scales be connected to mains (the power port is located at the back of the balance's housing).

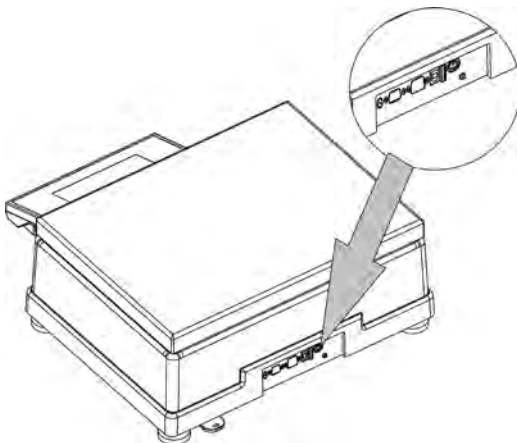

- Place the balance at the workplace.
- Using the wrench (3), after adjusting the balance level (see below); tighten the bolt (2) on the foot (1) to the balance's footing until the point of resistance.

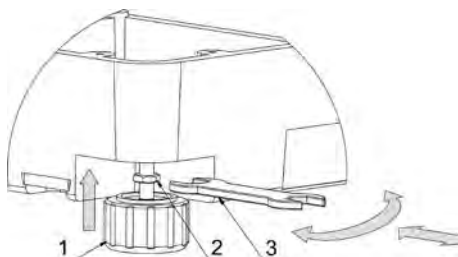

#### 4.3. Levelling



Before plugging to mains, level the balance by turning the adjustable feet in a way that the air bubble of the level is in its central ring. The balance should be placed at the workplace firmly on all of its feet.

#### 4.4. Cleaning

Balance should be cleaned with damp cloth by gentle wiping smudges of dirt. **Cleaning of the weighing pan when assembled may cause damage of the measuring system of the balance.** Hence, it is crucial to remove it from the balance before cleaning.



## 4.5. Plugging to mains

**Balance can be connected to mains only with a power adapter that comes standard with the balance. Nominal power supply of the power adapter (specified on the data plate of the power adapter) should be compatible to the power from mains.**

Plug the balance to mains – the plugging socket is located at the back of balance housing.

The test of the display unit takes place after connecting to the power (all the elements and pictograms are backlit for a short time). Next, the name and the program number appears consequently, the indication will reach ZERO level (with reading unit depending on the balance). During the process of starting the balance, the test of the internal mass adjustment mechanism occurs (single location and elevation of the internal mass adjustment).



If the indication is different from zero, please press  button.

*NOTE: If the balance is “verified”, automatic adjustment/calibration occurs right after it has been switched on.*

## 5. BASIC FUNCTIONS

- **functions related to measuring units**
  - weighing in grams [g],
  - weighing in milligrams [mg] (in balances with  $d \leq 0.001g$ ),
  - weighing in kilograms [kg] (in balances with  $d \geq 0.01g$ ),
  - weighing in carats [ct],
  - weighing in units from beyond **SI** (*available only in non-verified instruments*):  
[lb], [oz], [ozt], [dwt], [tlh], [tls], [tlt], [tlc], [mom], [gr], [ti], [N], [baht], [tola]
  
- **functions related to working modes**
  - counting pieces,
  - checkweighing (control +/-),
  - dosing,
  - percent setup,
  - density determination of solids,
  - density determination of liquids,
  - animal weighing,
  - statistics
  - totalising
  - peak hold

- **functions related to setting a balance to ambient conditions at a workstation**
  - enabling and disabling autozero system,
  - setting parameter of measurement result averaging,
  - value release,
  - display backlight,
  - beep signal,
  
- **functions related to use of communication ports (RS232, USB, WIFI)**
  - setting communication port,
  - setting bound rate,
  - continuous data transmission in basic measuring unit,
  - continuous data transmission in current measuring unit,
  - automatic operation mode.

Balance can be used to weigh loads under the weighing platform – i.e. under hook weighing option. Balance software enables generating a report from adjustment process in a form of a printout containing modifiable data (see CAL REPORT)

## 6. KEYBOARD

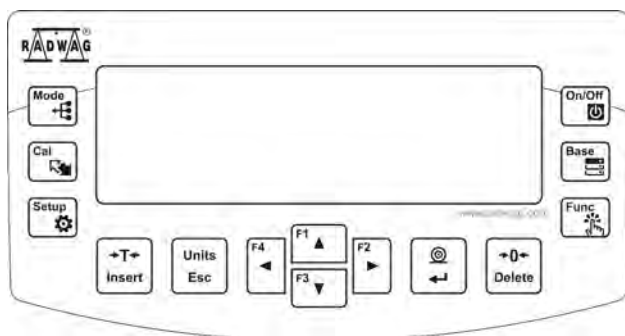

**ON/OFF** button enables switching on and off balance's display. If switched off balance components other than the display are powered, and balance is in stand-by mode.



**F** button. Function button, which enables quick entering the settings of an active working mode.



**MODE** button for selecting balance's working mode.



**UNITS** button changes measuring units.



**PRINT/ENTER** button- sends current display status to a peripheral device (PRINT) or accepts selected value of a parameter or function (ENTER).



**ZERO** button– zeroing of balance's indication.



**TARE** –taring of balance's indication.



Adjustment – function button of immediate initiating the adjustment / calibration process.



Function button for entering the main menu of a balance.

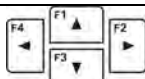

Navigating arrows for moving in balance's menu or changing parameter value.

## **7. START-UP**

When plugged to mains, the balance displays name and number of software, and afterwards proceeds to weighing mode.

### **7.1. Connecting peripheral devices**

The balance must be unplugged from the mains before connecting or disconnecting peripheral devices (printer or computer). Use only peripheral devices recommended by the manufacturer with your balance. These have been matched to your balance. After connecting a peripheral device, plug the balance to mains.

### **7.2. Balance temperature stabilisation period**

Before start of measuring processes, it is necessary to wait until the balance is thermally stabilised.

For balances that were stored in much lower temperatures before plugging to mains (e.g. during winter period) thermal stabilisation should last approximately 4 hours for NPS balances, and 8 hours for NAS and NAPP balances. During the thermal stabilization, the indications on the display panel can change. Correct operation of a balance is possible within temperature range specified in technical parameters, see point 1.







It is recommended that ambient temperature changes at balance's place of use are very small (slow to change).

## 8. USER MENU

Balance menu is divided into 6 basic function groups. Each group has individual name starting with capital letter **P**.

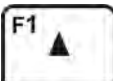
### 8.1. Moving through user menu

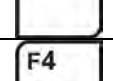
A user moves through balance menu using buttons on overlay's keyboard:

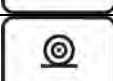
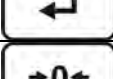
|   |   |
|---|---|
|    | <b>Setup</b> button. Entering balance's main menu.  |
|    | Selecting group of parameter one by one downwards or changing parameter value by one value downwards.                               |
|    | Selecting group of parameters one by one upwards or changing parameter value by one value upwards.                                  |
|    | Selecting group of parameters for activating. On pressing the button, the display indicates the first parameter in a selected group |
|    | Exit to previous menu level, e.g. to main menu.   |
|    | Abandon parameter changes.  |
|  | Accept / confirm introduced changes.  |
|  | Deleting a character while editing the text values of the menu, e.g. user name.   |
|  | Inserting a character while editing the text values of the menu, e.g. user name   |

Name of function groups and their content:

## **P1 ADJUSTMENT**

|                       |      |                                |
|-----------------------|------|--------------------------------|
| P1.1 INT. CALIB.      |      | [internal adjustment]          |
| P1.2 EXT. CALIB.      |      | [external adjustment]          |
| P1.3 USER CALIBRATION |      | [user adjustment]              |
| P1.4 CALIBRATION TEST |      | [adjustment test]              |
| P1.5 AUTO. CALIB.     | NONE | [automatic adjustment]         |
| P1.6 AUTO. CALIB. C.  | 1    | [time of automatic adjustment] |

---

## **P2 OPERATION MODE**

|                      |  |   |
|----------------------|--|---|
| P2.1 ACCESSIBILITY   |  | [settings for the accessibility of individual modes while working with the balance] |
| P2.2 WEIGHING        |  | [setting for the function weighing]   |
| P2.3 COUNTING PCS    |  | [settings for the function counting pieces]   |
| P2.4 CHECKWEIGHING   |  | [settings for the function checkweighing]   |
| P2.5 DOSING          |  | [settings for the function dosing]  |
| P2.6 DEVIATIONS      |  | [settings for the function deviations % against the mass of the standard]           |
| P2.7 DENS. OF SOLIDS |  | [settings for determining density of solids]  |
| P2.8 DENS OF LIQUIDS |  | [settings for determining density of liquids]                                       |
| P2.9 ANIMAL WEIGHING |  | [settings for the function animal weighing]   |
| P2.10 STATISTICS     |  | [settings for the function statistics]  |
| P2.11 TOTALISING     |  | [settings for the function totalising]  |
| P2.12 PEAK HOLD      |  | [settings for the function peak hold]   |

---

## **P3 COMMUNICATION**

|            |  |                                      |
|------------|--|--------------------------------------|
| P3.1 COM 1 |  | [transmission parameters port COM 1] |
| P3.2 COM 2 |  | [transmission parameters port COM 2] |
| P3.3 WIFI  |  | [transmission parameters port WIFI]  |

## P4 DEVICES

- P4.1 COMPUTER |COM 1/COM 2/USB/WIFI/NONE [PC connection port]  
P4.2 PRINTER |COM 1/COM 2/USB/WIFI/PENDRIVE/USB PC/NONE  
[printer connection port]  
P4.3 BARCODE READER |COM 1/COM 2/NONE [barcode reader port]  
P4.4 ADD. DISPLAY |COM 1/COM 2/NONE [additional display port]
- 

## P5 PRINTOUT

- P5.1 CAL. REPORT | [contents of the adjustment report]  
P5.2 HEADER | [contents of the header print-out]  
P5.3 GLP PRNT. | [contents of the weighment result prnt.]  
P5.4 FOOTER | [contents of the footer print-out]  
P5.5 NSD.PRN.1 | [project of non-standard print-out 1]  
P5.6 NSD.PRN. 2 | [project of non-standard print-out 2]  
P5.7 NSD.PRN. 3 | [project of non-standard print-out 3]  
P5.8 NSD.PRN. 4 | [project of non-standard print-out 4]  
P5.9 VARIABLE 1 | [project of variable 1]  
P5.10 VARIABLE 2 | [project of variable 2]
- 

## P6 OTHER

- P6.1 LANGUAGE |POLISH / ENGLISH [menu language]  
P6.2 ACCESS LEV. |ADMIN [access levels for editing menu]  
P6.3 KEY SOUND |YES/NO [key sound]  
P6.4 BACKLIGHT |70 [display backlight level]  
P6.5 DATE |2013.05.27 [data settings]  
P6.6 TIME |8:53:00 A [time settings]  
P6.7 DATE FORM.|YYYY.MM.DD/YYYY.DD.MM/DD.MM.YYYY/MM.DD.YYYY  
[date format]  
P6.8 TIME FORM. |12H/24H [time format]  
P6.9 GLP AUTOTEST | [carrying out autotest for the balance]
- 

## P7 INFO

- P7.1 BALANCE ID |  
P7.2 SCALETYPER. |  
P7.3 PROG. VER. |  
P7.4 TEMP. |  
P7.5 SETUP PRNT. |







### CAUTION

*Changes introduced in balance memory will be saved, when abandoning the menu (on return to weighing).  
Press **ESC** button several times.*

## 9. LOGGING IN

In order to have full access to the user's parameters and editing of database, the person operating the balance, should log in as **<ADMINISTRATOR>** each time they turn it on. The software enables the entry of 10 users with varying degrees of authority.

### The first login procedure

- While in the main window select **<LOG IN>**, available by pressing  or by pressing one of the function buttons to which the shortcut **<LOG IN>** is assigned, or after pressing the button , enter the users' database and select the user **<ADMIN>**
- After selecting the **< ADMIN>** button and confirming the choice by pressing , the program asks you to enter the user's password,
- You must enter „1111” and confirm by pressing ,
- The program returns to the main window,
- After the first login, you should first enter the users and assign the appropriate access levels to them (*procedures are described later in this manual, see section 14*).

The next time you log in, select a user from the list and enter the password. After that the program starts working with the permissions for the selected user.



If any user is logged in, the pictogram  is displayed.

### Logout procedure

- In order to log out, select **<NONE>** from the list of available users
- The program returns to the main window, and the display shows no logged-in user. (no logged-in user, no pictogram  on the display).



## Access levels

The balance software features three access levels: *ADMINISTRATOR*, *ADVANCED*, *USER*.

When you turn the balance on, the display is active all the time, which enables carrying out mass measuring processes.

**The table below shows the access to the edition of user parameters, databases and software functions depending on the access level.**

| <b>Access</b> | <b>Access levels</b>   |
|---------------|--|
| <b>USER</b>   | Access to parameters in the submenu: <Reading> and setting in parameter group <Others> except for <Date and Time>. All the weighing processes can be started and carried out at this time. The user has the access to the information preview in <Databases>, and can also define universal variables. |
| <b>ADV</b>    | Access to editing of parameters in the submenu: <Reading>; <Working modes>; <Communication>; <Devices>; <Others> except for <Date and Time>. All the weighing processes can be started and carried out at this time.   |
| <b>ADMIN</b>  | Access to all the user parameters, functions and editing databases.  |

## 10. WEIGHING

### 10.1. Required weighing procedures

In order to ensure long lasting use of a balance and reliable measurement of weighed loads, follow below procedures:

- Start the balance with no load on the weighing pan (permissible value of load on the weighing pan on balance start is  $\pm 10\%$  of its maximal capacity).
- Load balance's weighing pan steadily with no shocks:

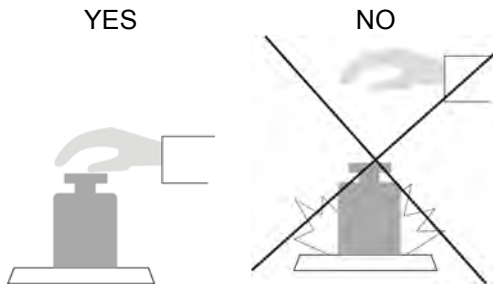

- Place weighed loads centrally on the weighing pan:

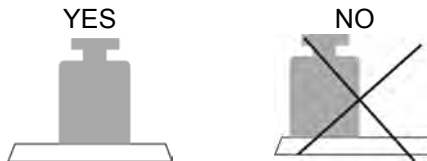

- Avoid side loading, in particular side shocks:

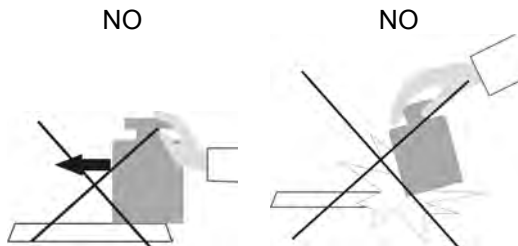

Before the start of weighing process or in case of drastic change of ambient conditions at a workstation (e.g. ambient temperature change at a workstation more than 3°C) the balance requires adjusting. The procedure of balance adjustment is described further in this user manual.

- Before the start of weighing procedure, it is recommended to load the balance's weighing pan a few times with mass close to balance max capacity,
- Check if unloaded balance indicates "precise zero"  $\rightarrow 0 \leftarrow$  and whether measurement is stable  $\blacktriangle \blacktriangledown$ , if not, press  $\rightarrow 0 \leftarrow$  / **Delete** button,
- Press **UNITS** button, to set a measuring unit: [g], [mg], [ct], and also if enabled in factory menu (non-verified balances) [kg], [lb], [oz], [ozt], [dwt], [tth], [tts], [tlt], [tlc] [rom], [gr], [ti], [N], [baht], [tola]
- Place weighed object on balance's weighing pan and read result only on stabilisation of measurement result,
- Mass indication of a load placed on balance's weighing pan can be tarred for multiple Times by pressing  $\rightarrow T \leftarrow$  / **Insert** (pay attention not to exceed maximal capacity of a balance by applying multiple tare function).

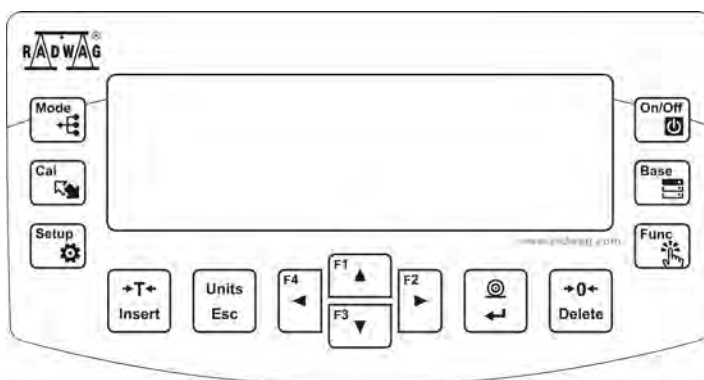

During times between carrying out the following measurement series do not unplug the balance from mains. It is recommended to switch off the balance's display by pressing **ON/OFF** button. On repeated pressing of the **ON/OFF** button the balance is ready for operation and carrying out the following measurements.

## 10.2. Zeroing



In order to zero mass indication press  button.

The mass indication on the display should equal zero, and precise zero  $0$  and stability marker  $\blacktriangle\blacktriangleleft$  should appear.

Zeroing process is tantamount to determining new zero point recognised by the balance as precise zero. Zeroing is possible only in stable status of display indication.

### **Caution:**

*Zeroing the display indication is possible only within the  $\pm 2\%$  range of instrument's maximal capacity. If the zeroed value is above the  $\pm 2\%$  of the maximal capacity, then the software indicates an error message **Err2**.*

## 10.3. Taring

In order to determine the net weight of a weighed object, place object's container (packaging) on balance's weighing pan, and on stabilisation of



measurement result press  button. The display should indicate mass equal to zero and symbols: **Net** and  $\blacktriangle\blacktriangleleft$ .

On taking off the weighed load and its packaging from instrument's weighing pan, the display indicates sum of total tared mass with minus sign.

The software also enables assigning tare value to a product from a database. Then, on product selection from a database, the software automatically uploads data on tare value for the specific product.

### **Caution:**

*Taring negative values is impossible. On taring negative values the balance responds with an error message **Err3**. In such case zero balance's indication and repeat taring procedure.*



## Manual tare determination

Procedure:



- While in optional mode press quick access button **F**, to which the option **<ENTER TARE>** is assigned in **<SHORTCUTS>** settings (*description of the setting further in this user manual, point <F button shortcuts>*),
- which opens a window,
- use the arrow buttons to enter tare value and press  button,
- the balance returns to weighing mode, and the display indicates entered tare value with minus „-“ sign.

## Selection of tare from TARE DATABASE

Procedure:

- while in any working mode, press **F** – quick access button, to which option **<SELECT TARE>** is assigned in **<SHORTCUTS>** (*description of the setting further in this user manual, point <F button shortcuts>*), or choose option **<SELECT TARE>** after pressing  button,
- which displays the first mass value of the mass packages that was saved in tare database,
- use the arrow buttons to select the tare which is to be recalled and press  button,
- the balance returns to the weighing mode, and the display indicates entered tare value with minus „-“ sign.

Or

- While in any working mode press  button,
- Enter **b3** option **<TARE>**
- Which displays the first mass value of the mass packages that was saved in tare database,
- Use the arrow buttons to select the tare which is to be recalled and press  button,
- The balance returns to the weighing mode, and the display indicates entered tare value with minus „-“ sign.

## Deleting tare



Entered tare value can be deleted by pressing  button on the balance's overlay or by entering tare value of 0.000g (see description above).

### 10.4. Settings for mode <WEIGHING>

The software allows the set-up of operating parameters (filters, value release and autozero option, deleting the last digit and other settings) separately for each working mode.

It enables customising the instrument and utilising properties depending on the user's needs and expectations or specific requirements for selected working mode (e.g. DOSING); as a result the work is quick and easy.

#### Available settings

##### P2.2.1 – READOUT

P2.2.1.1 – FILTER [V.FAST/ FAST / NORMAL / SLOW / V. SLOW]

P2.2.1.2 – RESULT CONF. [REL. / FAST / FAST+REL.]

P2.2.1.3 – AUTOZERO [YES / NO]

P2.2.1.4 – LAST DIGIT [ALWAYS / NEVER / WHEN STAB.]

**P2.2.1.5 – AMBIENT CONDITIONS (STABLE/UNSTABLE)**

##### P2.2.2 – PRINT MODE

P2.2.2.1 – MODE [EACH / WHEN STAB. / AUTO]

P2.2.2.2 –AUTO. PROG

##### P2.2.3 – UNITS

P2.2.3.1 – AVAILABILITY

P2.2.3.2 –START UNIT [G]

P2.2.3.3 – USER UNIT1

P2.2.3.4 – USER UNIT2

##### P2.2.4 – INFORMATION [TARE / NETTO / GROSS / USER / PRODUCT / /NSTD. INF. / NONE]

P2.2.5 – INF. NSTD. (non-standard information – any text, max 19 characters)

##### P2.2.6 – SHORTCUTS (available options depending on the working mode)

P2.2.6.1 – F1 [NONE / ENTER TARE/ ...]

P2.2.6.2 – F2 [NONE / ENTER TARE / ...]

P2.2.6.3 – F3 [NONE / ENTER TARE/ ...]

P2.2.6.4 – F4 [NONE / ENTER TARE / ...]

#### Setting level of filtering

Depending on the balance working conditions you should set the filter. In ideal conditions you can set the filter to be very fast (parameter value P.2.2.1.1 Filter to be V.FAST); however, if the working conditions are bad (shakes, drafts), the filter

should be set to slow or very slow (parameter value P.2.2.1.1 to SLOW or V. SLOW). The effectiveness of the filter is different for the weighing range. The filter works slower when “approaching” the weighed mass, it works more intensively when the weighed mass is placed within the set range of the filter (parameter filter range is accessible only from the service menu – the user does not have an access to it).

Depending on the adjusted filter, the weighing time will be shorter (V.FAST and FAST) or longer (SLOW and V. SLOW)



**ATTENTION**

*The higher level of filtering, the longer the weighing time.*

**Value release**

Due to various ambient conditions at workplaces, and in order to set balance to present conditions, it is necessary to determine the value release parameter as: **FAST.+REL.**, **FAST** or **RELIABLE**. Depending on selected option, weighing time is either shorter or longer.

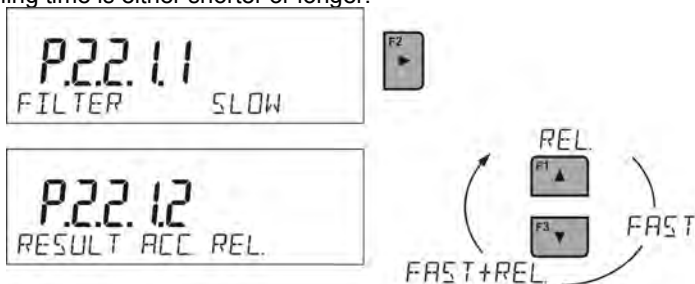

## Autozero function

In order to ensure balance's precise mass indication, autozero (**Auto**) software parameter has been introduced. The application of this function is automatic control and correction of zero indication. When the function is enabled, it compares balance indications at declared time interval e.g. 1s, on condition that weighing pan is unloaded and display indication is close to zero. If results vary less than declared AUTOZERO range e.g. one division, balance will zero automatically, marker of stable measurement result-  and precise zero marker - **0** - will be displayed.

If AUTOZERO function is enabled, then each weighing process starts from precise zero point. There are, however, some case when this function can be a disturbing factor in the measuring process; for instance very slow placing of load on the weighing pan (e.g. load pouring) in such case zero indication correction can also correct actual indication of loaded mass.

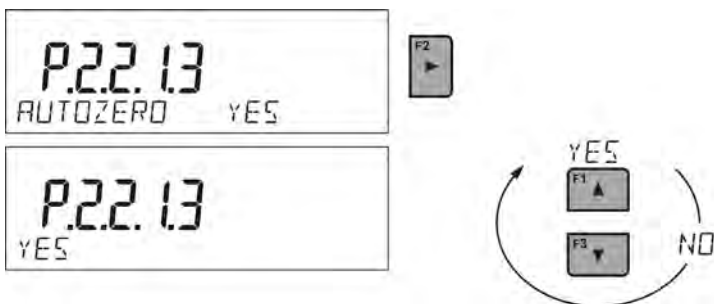

## Displaying the last digit

Function enables displaying the last digit on the balance display.

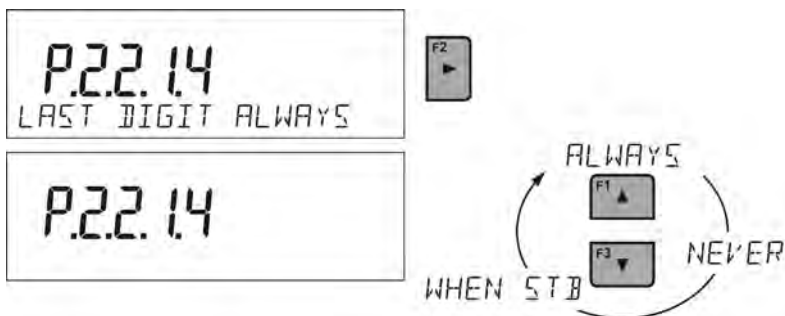



## Balance ambient conditions

This parameter has two settings: STABLE and UNSTABLE. Setting on STABLE mode makes the balance work much faster than on UNSTABLE mode. This parameter relates to the ambient conditions in which the balance operates. If the ambient conditions are unstable it is recommended to use UNSTABLE mode. Normally the parameter is set on: STABLE.

## 10.5. Printing mode



This function enables setting the printing mode, i.e. button activity. A user has the possibility of selecting the following settings:

- <WHEN STAB> the stable measurement result, along with the settings for parameter < GLP PRINTOUT> are sent to the printer port. Pressing



the button, when the result is not stable (no  sign on display), the balance software will send the measurement result to the port after reaching the stable condition of the measurement.



- <ANYONE> every single pressing of  button results in sending the measurement result to the printer port along with the settings for parameter <GLP PRINTOUT>. Every measurement result is sent (stable and unstable). The <?> sign appears at the beginning of the printing frame when the result is unstable.

***This function applies only to non-verified balances.***

- <AUTO> - select this option to enable automatic printing of measurements. If this option has been selected, remember to select <AUTO PROG > parameter to suit your needs.

### Automatic operation proceeds as follows:



- Press  button to zero the balance (marker of stable measurement  and zero marker  are shown on display)
- Place the load, the balance sends the first stable measurement to the printer port,
- Remove the load from the balance,
- Next measurement is possible when the reading on the display is lower than the set value of < AUTO PROG. > parameter (next measurement does not require zero value).

This procedure applies to changing settings:

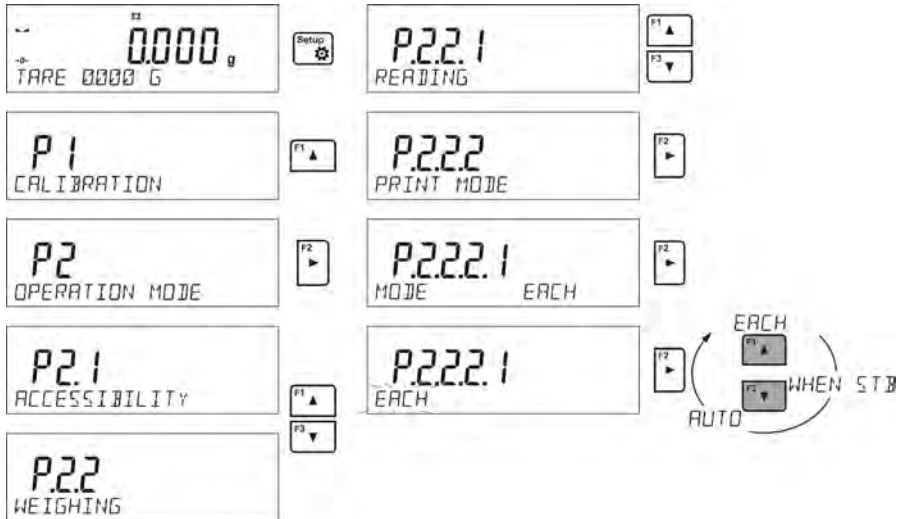

For automatic working mode adjust the threshold value.

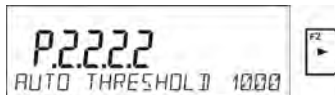





## 10.8. Availability of measuring units

This function is only available in <WEIGHING> mode. In other modes measurements are only possible in basic unit [g].

The user can declare the weighing units which will be available when selecting

Units

Esc

temporary unit by pressing   button. For these units the parameter availability is set to <YES>. These parameters can be selected by the user.

Procedure:

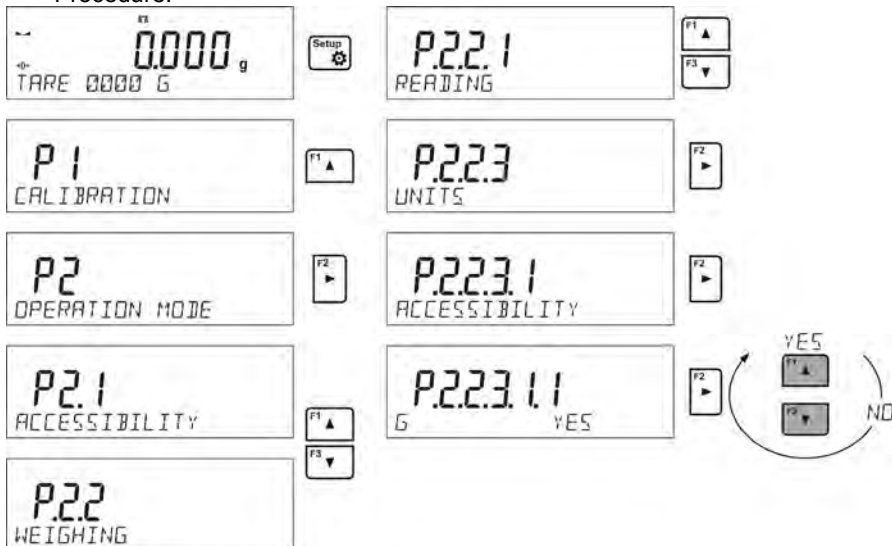

## 10.9. User unit

A user can declare two weighing units. User unit is the result of balance indication multiplied by the factor that was introduced for user unit.  
User units are marked as **[u1]** – user 1 unit and **[u2]** – user 2 unit.

The way of declaring factor for an individual user is shown below



User units are available only for non-verified balances.

## 10.10. Information

Function enables displaying additional information in the bottom line. Depending on the needs, a user can choose the following options, which are shown while working in mode **<WEIGHING>**:

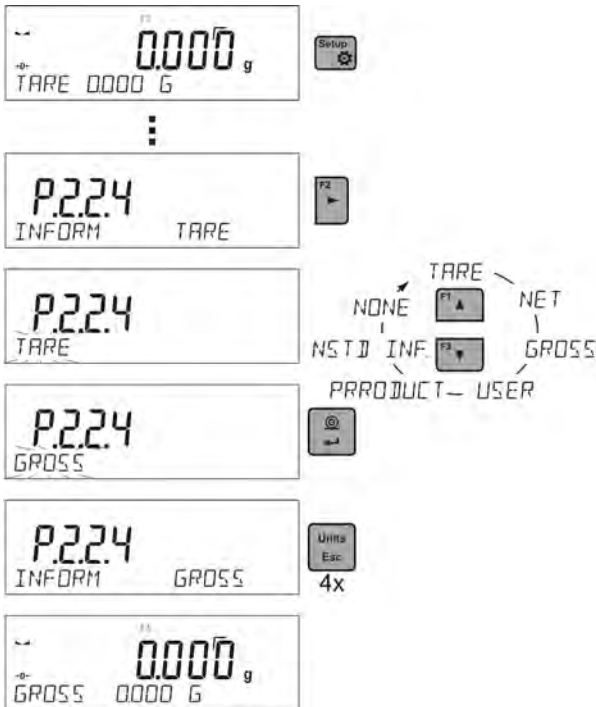

## 10.11. Non-standard information

Function enables declaring non-standard information, which is to be displayed in the bottom line of the display. A user can insert any text consisting of maximum 19 characters.

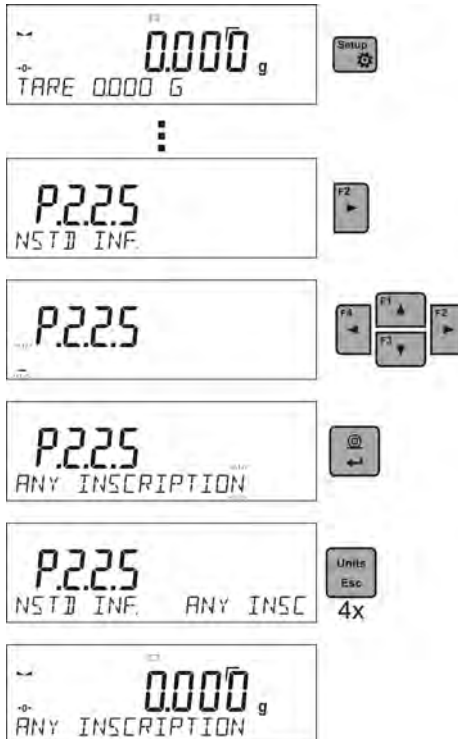

It should be remembered though, that the declared non-standard information is visible. Therefore, option **P2.1.2** should be set to **< NSTD. INF. >**.

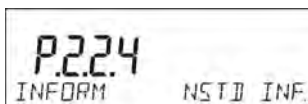

## 10.12. F button shortcuts

Function enables assigning quick access option for weighing functions which are accessible by choosing F1, F2, F3 or F4. A user can choose the following options in <WEIGHING> mode, which can be assigned to any of the F buttons< NONE / ENTER TARE / PRINT HEADER / PRINT FOOTER / VARIABLE 1 / VARIABLE 2>. There are different options available in other modes (see further on in this manual).



⋮



NONE  
 VARIABLE 2 → F1 ▲ CHOOSE PRODUCT  
 VARIABLE 1 ← F3 ▼ LOG IN  
 PRINT FOOTER ← F3 ▼ ENTER TARE  
 PRINT HEADER ← F3 ▼ CHOOSE TARE



4x



## Dual range balance (NPS 200/2000.R2)

Balance **NPS 200/2000.R2** series is a dual range weighing instrument. The accuracy of the **I weighing range** is  $d_1=0.001g$ , and of the **II weighing range** is  $d_2=0.01g$ .



Transfer from weighing with the accuracy of the **I weighing range** to weighing with the accuracy of the **II weighing range** takes place automatically on exceeding  $Max_1$  200g (with no user activity needed). On switching to weighing with the accuracy of the II weighing range, the display signals by indicating **→|2|←** symbol on its left side, and an additional marker of last but one digit of the weighing result.

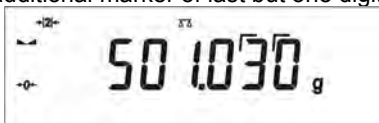

From now on the balance weighs mass with the accuracy of the **II weighing range**.



To return to weighing in the accuracy of the **I weighing range**:

- Take the weighed load off the weighing pan



- As the indication returns to zero and pictograms **→0←** and **▲▲** are lit,

press  button.



The balance returns to weighing with the accuracy of the I weighing range, and II weighing range **→|2|←** pictogram and marker of the last but one digit are blanked.

## 11. OTHER PARAMETERS

A user can set up parameters which have an influence on working with the balance. These parameters are included in group **P6 OTHER**.

Changing settings for particular parameters is the same as described in the previous paragraph of this user manual.

### **P6 OTHER**

|                   |   |   |
|-------------------|---|---|
| P6.1 LANGUAGE     | POLISH / ENGLISH                                  | [menu languages]                        |
| P6.2 ACCESS LEV.  | ADMIN   | [access levels for editing menu]        |
| P6.3 KEY SOUND.   | YES/NO  | [key sound]                             |
| P6.4 BACKLIGHT    | 70  | [display backlight level]               |
| P6.5 DATE         | 2013.05.27  | [date settings]                         |
| P6.6 TIME         | 8:53:00 A   | [time settings]                         |
| P6.7 DATE FORM.   | YYYY.MM.DD / YYYY.DD.MM / DD.MM.YYYY / MM.DD.YYYY | [date format]                           |
| P6.8 TIME FORM.   | 12H / 24H   | [time format]                           |
| P6.9 GLP AUTOTEST |   | [carrying out autotest for the balance] |
| P6.10 SETUP PRNT. |   | [balance parameters print-out]          |

Enter group **P6 OTHER** menu.

#### **11.1. Available menu languages**

Enables selecting the balance menu descriptions.

Available languages: POLISH, ENGLISH

#### **11.2. Access levels**

Enables choosing access levels when entering the balance menu.

Available access levels: ADMIN. / USER. / ADV.

Depending on the option selected, a user of a specific access level can access and make changes to the settings in the balance.

#### **11.3. 'Beep' sound – reaction on pressing function button**

Enables switching on/ switching off the 'beep' sound, which informs a user about pressing any button on balance's overlay.

|            |                             |
|------------|-----------------------------|
| <b>NO</b>  | - 'beep' sound switched off |
| <b>YES</b> | - 'beep' sound switched on. |

#### 11.4. Backlight and adjusting display brightness

Enables setting the brightness of the backlight or switching off the display brightness completely.

**100** - maximum brightness of the backlight

**10** - minimum brightness of the backlight

**NONE** - display brightness switched off

#### 11.5. Date

Enables setting the current date.

As follows:



#### 11.6. Time

Enables setting the current time.

As follows:

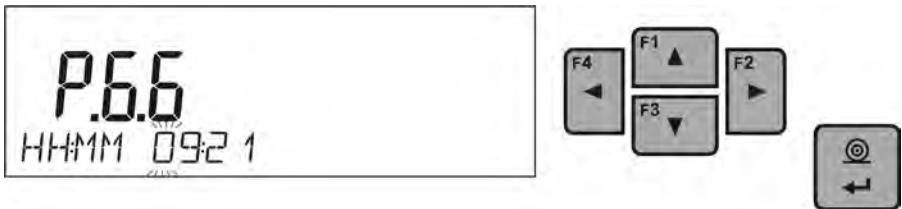

#### 11.7. Date format

Enables altering the date format on the printout  
[YYYY.MM.DD / YYYY.DD.MM / DD.MM.YYYY / MM.DD.YYYY]

Where:

YYYY – year

MM – month

DD - day

## 11.8. Time format

Enables choosing the time format on the printout [12H / 24H].

For the set value [12H], in parameter **P6.6 TIME** letters <A> or <P> will be displayed next to the time value.

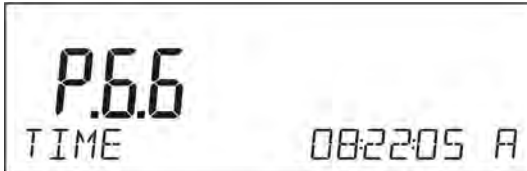

Where:

**A** stands for hours before noon, **P** stands for hours after noon.

Letters **AM** or **PM** are printed out next to the time value.

## 11.9. GLP autotest

AUTOTEST function is designed to aid a user in assessing balance's operation and diagnosing the reasons for occurrence of errors in weighing which exceed the maximum permissible values for a given balance model.

By means of a simple, repeatable and fully documented way the function enables optimizing balance's settings to maintain the best possible repeatability and weighing time at workstation. The main purpose of the function is the possibility of monitoring the above-mentioned parameters at optional moment and saving records from the carried out tests in the form of printed reports of the tests that are automatically generated at the end of examination.

The test controls repeatability of placing the interval weight and determining error of indication with reference to balance's maximum capacity.

Testing procedure:

- two times loading of the internal weight, followed by 10 times loading of the internal weight
- balance internal adjustment
- calculating the value of standard deviation
- report printout

Test results:

\*Deviation for Max.

\*Value of repeatability of indication expressed as standard deviation

### Example of a report:

----- Autotest GLP: Report -----  
Balance type PS 3000.R2  
Balance ID 400010  
User Admin  
Software rev. v.0.4.9  
Date 2013.07.16  
Time 09:17:16  
-----  
Number of measurements 10  
Reading unit 0.001/0.01 g  
Internal weight mass 1402.094 g  
Filter Normal  
Value release Fast & Reliable  
-----  
Deviation for Max. -0.118 g  
Repeatability 0.0088 g  
Signature  
-----

### PROCEDURE:



Parameter <P6.9 GLP AUTOTEST > is initiated by pressing  button.

The balance software starts the autotest GLP procedure and it is carried out automatically from now on to the end.

A user can stop the procedure at any time by pressing  button in the window. Once the procedure is finished, the value of standard deviation of all measurements is shown in the main display, and message <RESULT> in the bottom line, and the final report is printed out automatically (as shown above). It is

possible to print out the report again by pressing  button.

Report is not saved, therefore when abandoning this level, it is deleted from the balance volatile memory.

To abandon the window press  button and the program returns to the main menu. To return to weighing press  button repeatedly.

## 12. INFORMATION ABOUT THE BALANCE

This menu includes information about the balance and its installed software. The parameters are strictly informative.

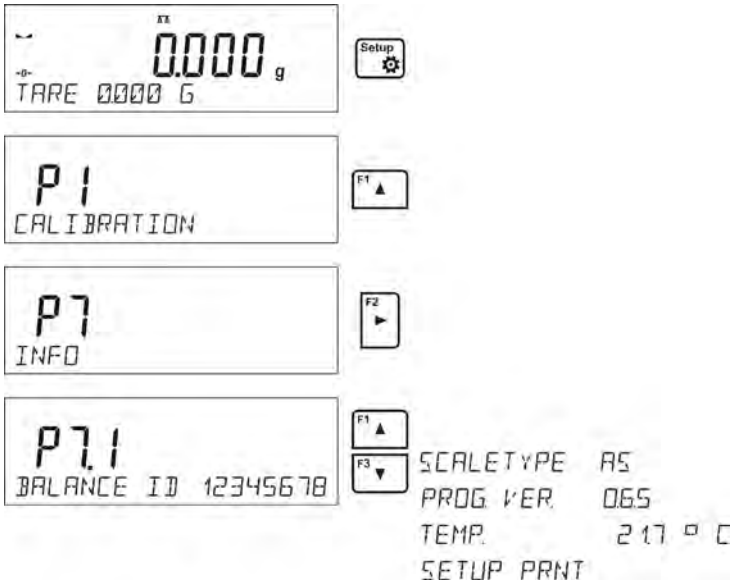

Once the parameter <PRINT. SET>> is chosen, the balance settings are sent to the printer (all parameters). The parameters are transferred via port that was chosen for <PRINTERS>.

### 13. BALANCE ADJUSTMENT

In order to ensure the highest weighing accuracy, it is recommended to periodically introduce to balance memory a corrective factor of indications in relation to a mass standard – i.e. balance adjustment.

#### Adjustment should be carried out:

- Before the beginning of weighing procedure,
- If long breaks between following measuring series occur,
- If temperature inside the balance changes more than: 3°C.

#### Types of adjustment:

- Internal automatic adjustment
  - \* triggered by temperature change
  - \* triggered by elapsing time
- Manual internal adjustment
  - \* initiated by pressing 
- Adjustment with external weight
  - \* with declared mass which cannot be modified
  - \* of any weight, but not lower than 30% of maximum range.



#### CAUTION

*In case of verified balances (with internal automatic adjustment system) only the automatic internal adjustment and manual internal adjustment system are available for a user. Remember to carry out the adjustment process when there is no load on the pan! In case there is load on the weighing pan, the display will indicate a command <RANGE EXCEEDED>. In such a case the load should be removed from the weighing pan and the process of the adjustment should be finished. Adjustment process can be aborted if necessary by pressing **Esc** at any time during the process.*

### 13.1. Internal adjustment

Adjustment process can be initiated automatically and manually.

Manual means of activating adjustment procedure is achieved by pressing



. System of automatic adjustment will carry out the process fully automatically and will inform the user on successive process stages.

#### Cycle of automatic adjustment process:

- Balance software detects the necessity of carrying out adjustment and signals it by displaying a thermometer pictogram and <Cal> at the top of the display.



- During this time interval of about 2 minutes within which weighing procedure can be completed
- As the 2 minute time elapses, balance display indicates message **CAL\_30** and starts counting down from 30..29..28 to 0 (indicated value is the counter),



- Balance user has 30 seconds to make a decision
  - In order to start adjustment, do not take any actions
  - In order to complete weighing procedure, press **Esc**. When pressed, balance returns to weighing procedure and displays last weighing result. In about 5 minutes balance indicates **CAL\_30** message again.
- The adjustment process can be postponed for multiple times, but it needs to be pointed out that postponing of adjustment for a long time may lead to larger errors of weighing process. The errors are the effect of temperature changes and as a consequence changes of balance sensitivity.



## Automatic adjustment process takes place in three different areas:

- Adjustment on plugging the balance to mains – verified balances.
- Adjustment triggered by temperature change inside the balance. The balance is equipped with very precise system for monitoring temperature. At each adjustment process, the temperature is saved in the system. The next adjustment is automatically initiated if temperature changes more than 3°C from the last saved temperature.



- Adjustment triggered by elapsing time. It is possible to declare time intervals which are criteria for balance adjustment. Accessible settings are: adjustment after 1, 2, 3, 4, 5, 6, 7, 8, 9, 10, 11, 12 hours since last carried out adjustment procedure,



### ATTENTION



*Declaring time intervals for balance adjustment is available only in non-verified balances. In case of verified balances the time interval between the following adjustments is set for 3 hours.*

## 13.2. Menu adjustment settings

### P1 CALIBRATION

|                    |  |   |
|--------------------|--|---|
| P1.1 INT.CALIB.    |  | [internal adjustment]                       |
| P1.2 EXT.CALIB.    |  | [external adjustment]                       |
| P1.3 USER CALIB.   |  | [user adjustment]                           |
| P1.4 CALIB. TEST   |  | [adjustment test]                           |
| P1.5 AUTO. CAL. T. |  | NONE/TIME/TEMP./BOTH [automatic adjustment] |
| P1.6 AUTO CAL. C.  |  | [time of automatic adjustment]              |

- **P1.1 INT. CALIB. – Internal adjustment**

Start of internal adjustment process. Adjustment is conducted automatically, and no user assistance is required. If weighing pan of the balance is loaded, balance will display a command to unload the weighing pan. If weighing pan is loaded with a relatively small mass (up to 4% of balance max capacity) then adjustment process will be carried out automatically, but measuring results may differ by the amount that was present on balance weighing pan.

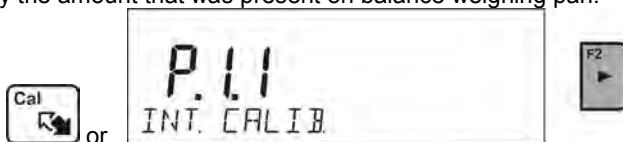

- **P1.2 EXT. CALIB. – External adjustment (with an external weight)**

Adjustment with external weight, which value is saved in factory menu of balance, function unavailable in verified balances.

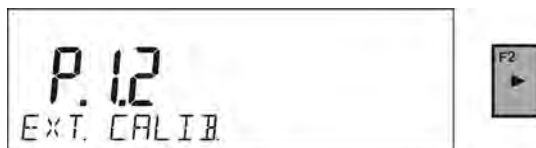

#### **ATTENTION**

*Function unavailable in verified balances.*

- **P1.3 USER CALIB. – User adjustment (with an external weight)**

Adjustment with external weight at any mass in the balance range, however, not lower than 30% of max range.



**ATTENTION**

*Function unavailable in verified balances.*

- **P1.4 CALIB. TEST – Adjustment test**

This function enables comparing the result of internal automatic adjustment with the value of internal weight saved in balance's factory parameters. The process is conducted automatically and its result is shown on the display (if the balance is connected via RS 232 port with a computer or printer, the adjustment result will be printed out). Press **ESC** to go back to the previous menu.

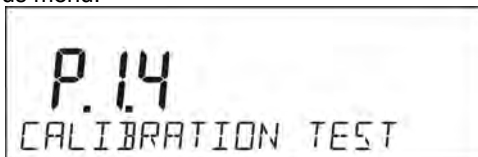

- **P1.5 AUTO. CALIB. T. – Temperature of automatic adjustment (balances with internal adjustment)**

Determination of factor which signals start of automatic internal adjustment

**NONE** - no factor will cause start of adjustment (adjustment automatically turned off)

**TEMP.** - adjustment triggered by change of temperature

**TIME** - adjustment triggered by time interval set in **P1.6 AUTO CALIB.**

**C.**

**BOTH** - adjustment triggered by time and temperature.



**ATTENTION**

*Function unavailable in non-verified balances.*

- **P1.6 AUTO CALIB. C. - Time of automatic adjustment (balances with internal adjustment system)**

Determination of time interval, after which automatic adjustment process is initiated.



**ATTENTION**

*Function unavailable in verified balances.*

### 13.3. Manual adjustment

#### Internal adjustments

Press **Cal** button

or



The balance performs internal adjustment automatically. During adjustment process do not load the weighing pan with any load. The message is displayed **<DO NOT TURN OFF CALIBRATION>** in the bottom line. Once adjustment process is completed, balance saves its result in memory and returns to weighing mode.

**ATTENTION**



- Press **Esc** button to abort adjustment process.

-If, during adjustment process, weighing pan of a balance is loaded, the display will show an error message. Adjustment will be stopped. As weighing pan is unloaded, the adjustment process will continue and be completed.

## External adjustment

The external adjustment in balances NPS series should be carried out with external mass standard / weigh class F<sub>1</sub>

Start of external adjustment process,

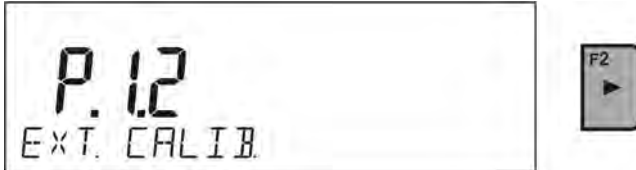

Balance will display a command ordering unloading of weighing pan <REMOVE MASS> (weighing pan must be empty). When weighing pan is

unloaded, press  button.

The balance determines mass of empty pan and message <CALIBRATION> is displayed in the bottom line. It is followed by message <PLACE MASS> in the bottom bar, and in the main window the mass value to be placed on the weighing pan e.g. **200.000g** (depending on the type of balance). Place an external adjustment weight with mass determined on

balance's display and press  button. The balance determines the mass and message <CALIBRATION> is displayed in the bottom line. On completing adjustment process the balance returns to submenu **P1.2 INT.CALIB.**



If a balance is verified, it is not possible for a user to carry out external adjustment process.

## User adjustment

The external adjustment in balances NPS series should be carried out with external mass standard / weigh class F<sub>1</sub>

Start of external adjustment process,



The first procedure of the process is to enter the mass of the weight that is to be used for adjustment. The mass must be  $\geq 30\%$  Max capacity.



Once the mass of the weight is entered and confirmed, the message is displayed which asks you to remove the weight from the pan **<REMOVE**

**MASS>** (weighing pan must be empty). After that, press  button, the balance determines the weight of unloaded pan and message **<CALIBRATION>** is shown in the bottom line .

Next, message **<PLACE MASS>** is displayed in the bottom bar, and in the main window the value of the mass to be placed e.g. **200.000g** (depending

on balance type). Place the weight of the indicated mass and press  button. The balance determines the mass and message **<CALIBRATION>** is displayed in the bottom line. After the adjustment process, the balance returns to submenu **P1.2 EXT.CALIB.**



If a balance is verified, it is not possible for a user to carry out external adjustment process.

#### 13.4. Adjustment report printout

At the end of each adjustment process or adjustment test, an adjustment report is generated automatically and sent to communication port COM 1. The content of the report is declared in menu P5.0 GLP PRINTOUTS.

The description of how to declare the settings for this option is included further in this manual, in the section on printouts.

The report can be printed out via the printer connected to the balance or it can be sent to the computer and saved as a file for archiving.

## 14. DETERMINING CONTENT OF A PRINTOUT

### 14.1. Adjustment report

**P5.1 CAL. REPORT**, is a group of parameters which enable declaring data that is on an adjustment printout.

#### P5.1 CAL. REPORT

|         |             |  |     |
|---------|-------------|--|-----|
| P5.1.1  | PROJECT     |  |     |
| P5.1.2  | CALIB. TYPE |  | YES |
| P5.1.3  | USER        |  | YES |
| P5.1.4  | PROJECT     |  | YES |
| P5.1.5  | DATE        |  | YES |
| P5.1.6  | TIME        |  | YES |
| P5.1.7  | BALANCE ID  |  | YES |
| P5.1.8  | CAL.DIFFER. |  | YES |
| P5.1.9  | DASHES      |  | YES |
| P5.1.10 | SIGNATURE   |  | YES |

- **P5.1.1 PROJECT**

Option enables entering the name of the project (e.g. associated with a specific type of weighing). The name can be up to 16 characters.

For instance, a project name entered into the balance in capital letters, looks like the figure below:

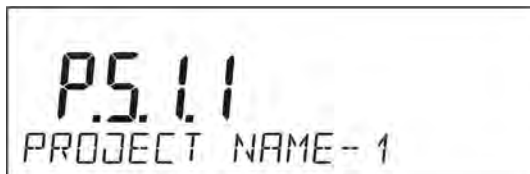

- **P5.1.2 CALIB. TYPE.**

Enables printing out the type of the adjustment being carried out.

- **P5.1.3 USER**

Enables printing out the name of logged-in user.

#### P5.1.4 PROJECT

Enables printing out the name of the project. (see parameter P5.0.1)

- **P5.1.5 DATE**

Enables printing out the date of the carried out adjustment.

- **P5.1.6 TIME**

Enables printing out the time of the carried out adjustment.

- **P5.1.7 BALANCE ID**

Enables printing out the balance ID number.

- **P5.1.8 CAL. DIFFER.**

Enables printing out the difference between the mass of adjustment weight measured during the last adjustment and the current measured mass of this weight.

- **P5.1.9 DASHES**

Enables printing out the dashes that separate the date of printout from the signature

- **P5.1.10 SIGNATURE**

Enables printing out the signature of a user performing the adjustment.

Choose one of the options for the above-mentioned parameters.

**NO** - do not print on the report

**YES** - print on the report

*Example of a report:*

|                       |                |
|-----------------------|----------------|
| -----Cal. Report----- |                |
| Calib. type           | Internal       |
| User                  | Admin          |
| Project               | Project name-1 |
| Date                  | 04.06.2013     |
| Time                  | 10:54:27 AM    |
| Balance ID            | 353870         |
| Cal. differ.          | 0.045 g        |
| -----                 |                |
| Signature:            |                |
| .....                 |                |



## 14.2. Header printout

**P5.2 HEADER**, is a group of parameters which enable declaring data that is on the header printout.

### P5.3 HEADER

|         |                    |  |  |
|---------|--------------------|--|--|
| P5.2.1  | DASHES             |  | YES  |
| P5.2.2  | WORKING MODES      |  | YES  |
| P5.2.3  | DATE               |  | YES  |
| P5.2.4  | TIME               |  | YES  |
| P5.2.5  | SCALE TYPE         |  | YES  |
| P5.2.6  | BALANCE ID         |  | YES  |
| P5.2.7  | USER               |  | YES  |
| P5.2.8  | PRODUCT            |  | YES  |
| P5.2.9  | VARIABLE 1         |  | YES  |
| P5.2.10 | VARIABLE 2         |  | YES  |
| P5.2.11 | EMPTY LINE         |  | YES  |
| P5.2.12 | CAL.REPORT         |  | YES  |
| P5.2.13 | NON-STANDART PRNT. |  | NONE / NSTD.PRN. 1 /<br>NSTD. PRN. 2 / NSTD.PRN.3<br>/ NSTD. PRN.4 |

- **P5.2.1 DASHES**

Enables printing out a line of separating dashes.

- **P5.2.2 WORKING MODES**

Enables printing out the name of balance's working mode.

- **P5.2.3 DATE**

Enables printing out the date in the header.

- **P5.2.4 TIME**

Enables printing out the time in the header.

- **P5.2.5 SCALE TYPE**

Enables printing out the scale type.

- **P5.2.6 BALANCE ID**

Enables printing out balance ID number.

- **P5.2.7 USER**

Enables printing out the name of a logged-in user.

- **P5.2.8 PRODUCT**

Enables printing out the name of a selected product.

- **P5.2.9 VARIABLE 1**

Enables printing out the value of VARIABLE 1.

- **P5.2.10 VARIABLE 2**

Enables printing out the value of VARIABLE 2.

- **P5.22.11 EMPTY LINE.**

Enables printing out an empty separating line.

- **P5.2.12 CAL. REPORT**

Enables printing out a report from the last adjustment, according to the settings declared for the adjustment report printout (see sec. 12.1 in this manual).

- **P5.2.13 NSTD. PRINT.**

Enables printing out one of the four non-standard printouts on the header printout.

You can choose one from the following options: NONE / NSTD. PRN 1 / NSTD.PR.N.2/NSTD.PR.N. 3 / NSTD. PRN.4

The way of entering non-standard printouts is described further in this manual.

For the parameters described above i.e. **P5.2.1 to P5.2.12** you should choose from:

|            |                              |
|------------|------------------------------|
| <b>NO</b>  | - do not print in the header |
| <b>YES</b> | - print in the header        |

For the parameter **P5.2.13**, you should choose one of the following options:  
NONE / NSTD.PR.N. 1 / NSTD. PRN 2 / NSTD.PR.N 3 / NSTD. PRN.4

Example of a header printout:

|               |            |
|---------------|------------|
| Working modes | Weighing   |
| Date          | 24.07.2013 |
| Time          | 7:37:30    |
| ScaleType     | AS         |
| Balance ID    | 10353870   |
| User          | ADMIN ENG  |
| Product       | Tablet     |

### 14.3. Measurement result printout – GLP PRINTOUT

**P5.3 GLP PRINTOUT**, is a group of parameters which enable declaring data that is on the measurement result printout.

#### **P5.3 GLP PRNT.**

|         |             |  |  |
|---------|-------------|--|--|
| P5.3.1  | DATE        |  | YES  |
| P5.3.2  | TIME        |  | YES  |
| P5.3.3  | USER        |  | YES  |
| P5.3.4  | PRODUCT     |  | YES  |
| P5.3.5  | VARIABLE 1  |  | YES  |
| P5.3.6  | VARIABLE 2  |  | YES  |
| P5.3.7  | TARE        |  | YES  |
| P5.3.8  | GROSS       |  | YES  |
| P5.3.9  | CURR.RES.   |  | YES  |
| P5.3.10 | CAL. REPORT |  | YES  |
| P5.3.11 | NSTD.PRNT.  |  | NONE / NSTD.PRN. 1 /NSTD.PRN. 2 /<br>NSTD. PRN.3 / NSTD.PRN. 4 |

- **P5.3.1 DATE**

Enables printing out the date of measurement.

- **P5.3.2 TIME**

Enables printing out the time of measurement.

- **P5.3.3 USER**

Enables printing out the name of a logged-in user.

- **P5.3.4 PRODUCT**

Enables printing out the name of the product that was weighed.

- **P5.3.5 VARIABLE 1**

Enables printing out the value of VARIABLE 1.

- **P5.3.6 VARIABLE 2**

Enables printing out the value of VARIABLE 2.

- **P5.3.7 TARE**

Enables printing out the tare value.

- **P5.3.8 GROSS**

Enables printing out the gross mass value.

- **P5.3.9 CURR. RES.**

Enables printing out the current measurement result (NET mass) in the current unit.

- **P5.3.10 CAL. REPORT**

Enables printing out a report from the last adjustment, according to the settings declared for the adjustment report printout (see sec. 12.1 in this manual).

- **P5.3.11 NSTD. PRNT.**

Enables printing out one of the four non-standard printouts on the header printout.

You can choose one from the following options: NONE / NSTD. PRN 1 / NSTD.PRN.2/NSTD.PRN. 3 / NSTD. PRN.4

The way of entering non-standard printouts is described further in this manual.

*Example of a printout:*

|         |             |
|---------|-------------|
| Date    | 04.06.2013  |
| Time    | 11:11:24 AM |
| Product | NAZWA       |
| 0.000 g |             |

## 14.4. Footer printout

**P5.4 FOOTER**, is a group of parameters which enable declaring the data that is on the footer printout.

### P5.4 FOOTER

|         |               |  |  |
|---------|---------------|--|--|
| P5.4.1  | WORKING MODES |  | YES  |
| P5.4.2  | DATE          |  | YES  |
| P5.4.3  | TIME          |  | YES  |
| P5.4.4  | SCALE TYPE    |  | YES  |
| P5.4.5  | BALANCE ID    |  | YES  |
| P5.4.6  | USER          |  | YES  |
| P5.4.7  | PRODUCT       |  | YES  |
| P5.4.8  | VARIABLE 1    |  | YES  |
| P5.4.9  | VARIABLE 2    |  | YES  |
| P5.4.10 | DASHES        |  | YES  |
| P5.4.11 | EMPTY LINE.   |  | YES  |
| P5.4.12 | CAL.REPORT    |  | YES  |
| P5.4.13 | SIGNATURE     |  | YES  |
| P5.4.14 | NSTD. PRNT.   |  | NONE / NSTD.PRN. 1 /<br>NSTD.PRN.2/NSTD.PRN.3 /<br>NSTD. PRN.4 |

- **P5.4.1 WORKING MODES**

Enables printing out of the name of balance's working mode.

- **P5.4.2 DATE**

Enables printing out of the date in the footer.

- **P5.4.3 TIME**

Enables printing out the time in the footer.

- **P5.4.4 SCALE TYPE**

Enables printing out the scale type.

- **P5.4.5 BALANCE ID**

Enables printing out balance ID number.

- **P5.4.6 USER**

Enables printing out the name of a logged-in user.

- **P5.4.7 PRODUCT**

Enables printing out the name of a selected product.

- **P5.4.8 VARIABLE 1**

Enables printing out the value of VARIABLE 1

- **P5.4.9 VARIABLE 2**

Enables printing out the value of VARIABLE 2

- **P5.4.10 DASHES**

Enables printing out a line of separating dashes

- **P5.4.11 EMPTY LINE**

Enables printing out an empty separating line

- **P5.4.12 CAL. REPORT**

Enables printing out a report from the last adjustment, according to the settings declared for the adjustment report printout (see sec. 12.1 in this manual).

- **P5.4.13 SIGNATURE**

Enables printing out the signature of the user performing the weighments.

- **P5.4.14 NSTD. PRNT.**

Enables printing out one of the four non-standard printouts on the header printout.

You can choose one from the following options: NONE / NSTD. PRN 1 / NSTD.PRN.2/NSTD.PRN. 3 / NSTD. PRN.4

The way of entering non-standard printouts is described further in this manual.

For the parameters described above **P5.4.1 to P5.4.13** you should choose from:

**NO** - do not print in the footer  
**YES** - print in the footer

For the parameter **P5.4.14**, you should choose one of the following options:  
NONE / NSTD.PRN. 1 / NSTD. PRN 2 / NSTD.PRN 3 / NSTD. PRN.4

Example of a footer printout:

|           |            |
|-----------|------------|
| Date      | 24.07.2013 |
| Time      | 7:41:10    |
| User      | ADMIN ENG  |
| Signature |            |

#### 14.5. Non-standard printouts

The balance's software enables entering 4 non-standard printouts. Each of them can have approximately 160 characters.

##### Non-standard printout can include:

- Variables depending on the working mode and other user's needs (mass, date etc.)
- Permanent text in the user menu, it should be remembered, however, to use CAPITAL letters and without Polish characters
- Non-standard printout can have approximately 160 characters (typed as a single line)

##### Inserting texts

##### Variables in all modes and with the same values

|    |   |
|----|---|
| %% | Print-out of a "%" character            |
| %V | Current NET mass in the current unit    |
| %N | Net mass in the current unit            |
| %G | Gross mass in the current unit          |
| %T | Tare mass in the current unit           |
| %D | Current date                            |
| %M | Current time                            |
| %I | Balance number                          |
| %R | Program number                          |
| %P | Project number                          |
| %U | User number                             |
| %F | Name of current function – working mode |
| %C | Date and time of the last adjustment    |

|    |   |
|----|---|
| %K | Type of the last adjustment               |
| %Y | Weighing deviation to the last adjustment |
| %1 | Variable 1                                |
| %2 | Variable 2                                |

**Variables depending on the currently used working mode**

| Variable | Description         | Mode in which the variable is active |
|----------|---------------------|--------------------------------------|
| %W       | Standard mass 1 pcs | COUNTING PIECES                      |
| %H       | High threshold      | CHECKWEIGHING                        |
| %L       | Low threshold       |                                      |
| %A       | Target mass         | DOSING                               |
| %B       | Reference mass      | DEVIATIONS                           |

**Non-standard characters used in designing non-standard print-outs**

|    |                              |
|----|------------------------------|
| \\ | a single „\” character       |
| \C | CRLF                         |
| \R | CR                           |
| \N | LF                           |
| \T | Tabulator                    |
| \F | Form feed (for PCL printers) |

Every single print-out can have max 160 characters (letters, numerals, non-standard characters, spaces). A user can apply non-standard characters in order to the variables depending on the needs.

**Example:**

“RADWAG”  
DATE: <current measurement date>  
TIME: <current measurement time>  
PRODUCT MASS: <current mass indicator>

\*\*\*\*\*SIGNATURE:.....

<current working mode>





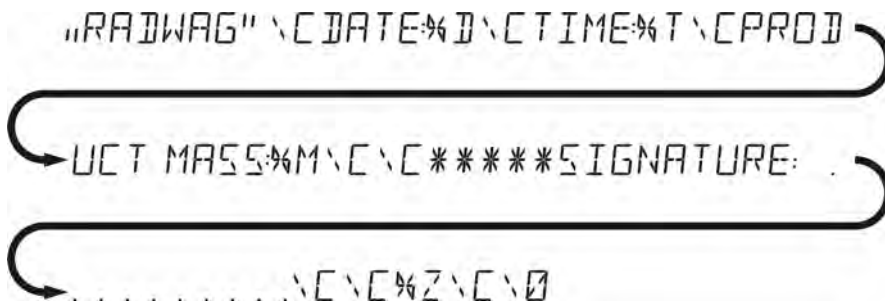



You should enter the printout of the content setting and design the printout using appropriate variables and text format characters.



### The way of inserting texts

#### – By the means of balance

|   |  |
|---|--|
|    | Choice of the character to be changed. Moving the cursor or an active character (blinking) to the right. |
|    | Choice of the character to be changed. Moving the cursor or an active character (blinking) to the left.  |
|    | Change of the character by one value down  |
|    | Change of the character by one value up  |
|   | Deleting a character   |
|  | Inserting a character  |

#### – By the means of computer keyboard of the USB type

A computer keyboard of the USB type can be connected, which enables easier and quicker editing of the print-outs.

In order to insert text, you should enter the appropriate option in the menu and with help of the keyboard insert the text and confirm by pressing Enter key.

#### NOTE:

*It is important to type variables used for non-standard printouts in capital letters.*

## **14.6. Variables**

Variables are alphanumeric information which can be linked to the printouts, products or other information related to weighing. For every variable enter its contents. Variables can be used for entering e.g. serial number or batch number during the products weighing. The program allows to enter two variables. Each can contain max 32 characters.

In order to enter a variable, you need to enter the variable settings (parametre P5.9 – VARIABLE 1 or P5.10 – VARIABLE 2) and enter its contents using direction keys (arrows) on the balance keypad or a computer keyboard. Entering texts procedure is the same as for non-standard printouts.

## 15. DATABASE

The balance software has 3 databases that can be edited (USERS, PRODUCTS, TARES) as well as 2 databases (WEIGHTMENTS AND ALIBI), in which all the measurements carried out on the balance are saved.

Data range that can be saved in particular databases:

**USERS** – 100 different users.

**PRODUCTS** – 1000 different products.

**TARES** – 100 different masses of the packages.

**WEIGHTMENTS** – 10 000 consecutive measurements

**ALIBI** – 100 000 consecutive measurements

Operations on databases: USERS, PRODUCTS and TARES:

---



Deleting the selected item in the database

---



Inserting a new item in the database

---

The way of inserting and deleting an item is described below.

### 15.1. Users

**USERS** – 100 different users.

It is possible to introduce the following data for each user:

**NAME** (30 characters), **CODE** (6 characters),

**PASSWORD** (8 characters, just numbers),

**ACCESS** (USER, ADVANCED, ADMIN),

**LANGUAGE** (any from the available).

#### Access levels

The balance software has three access levels: *USER*, *ADVANCED*, *ADMINISTRATOR*.

Once the balance is switched on, the display is active for the whole time, which enables carrying out mass measurements even without a logged-in user.

**The table below shows the access to the edition of user parameters, databases and software functions depending on the access level.**

| Access       | Access levels  |
|--------------|--|
| <b>USER</b>  | Access to parameters in the submenu: <Reading> and setting in parameter group <Others> except for <Date and Time>. All the weighing processes can be started and carried out at this time. The user has the access to the information preview in <Databases>, and can also define universal variables. |
| <b>ADV</b>   | Access to editing of parameters in the submenu: <Reading>; <Working modes>; <Communication>; <Devices>; <Others> except for <Date and Time>. All the weighing processes can be started and carried out at this time.   |
| <b>ADMIN</b> | Access to all the user parameters, functions and editing databases.  |

In order to add a user, follow the scheme shown below, add a user and assign a name to them.

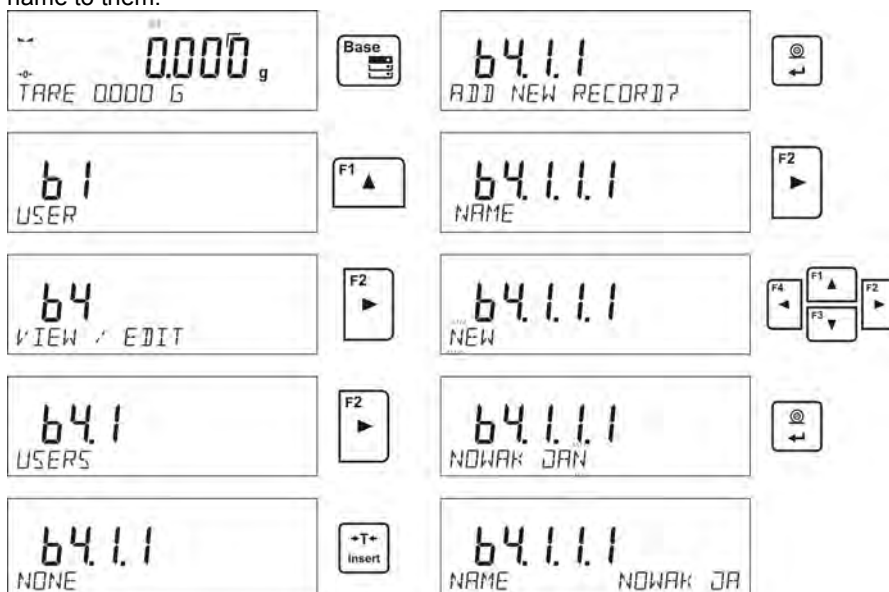

Once the user's name is added, follow the procedures shown below:

User's code – Max 6 characters

64.1.12  
CODE



User's password – Max 8 numbers

64.1.13  
PASSWORD \*\*\*\*\*

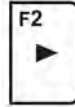

Select the access level

64.1.14  
ACCESS LEV USER



64.1.14  
USER

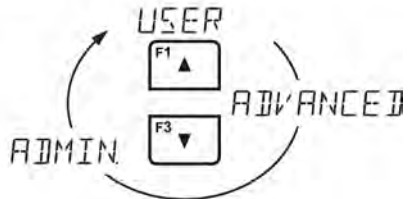

64.1.14  
ACCESS LEV ADMIN

Select the language

64.1.15  
LANGUAGE ENGLISH



Once all of the data is inserted, you can return to the weighing mode.

In order to select a user, follow the logging-in procedure described in section 9 in this manual.

**In order to remove a user should follow this procedure:**

- Enter the user database – as in the description above
- Select the user that is to be removed from the list

- Press  button

- The software shows <DELETE?> in the bottom line



- Confirm by pressing button
- When confirmed, the software removes the selected user from the list
- Return to the weighing mode

## 15.2. Products

**PRODUCTS** – 1000 different products. The following data can be inserted for each product: NAME (30 characters), CODE (6 characters), EAN (16 characters), MASS (with the accuracy of balance reading unit), TARE (mass of the packaging relating to a particular product with the accuracy of balance reading unit), MIN (low threshold for the mode WEIGHING>, should be inserted with the accuracy of balance reading unit), MAX (high threshold for the mode <CHECKWEIGHING>, should be inserted with the accuracy of balance reading unit), TOLERANCE (tolerance thresholds to [±] in mode <DOSING> entered as a % of the target mass).

In order to add a product, you should enter in the products database and add the name of the product (follow the procedure as in the section above).

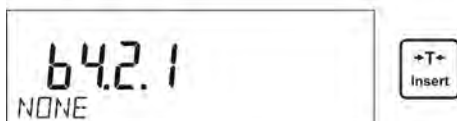

Next, insert the details about the product.

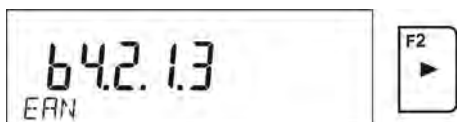
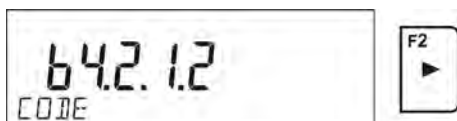

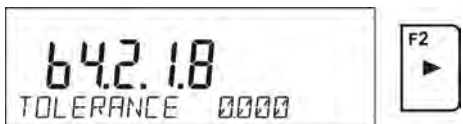
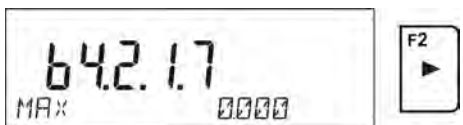
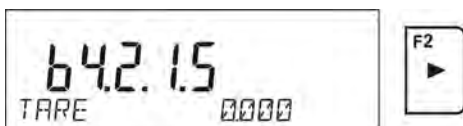
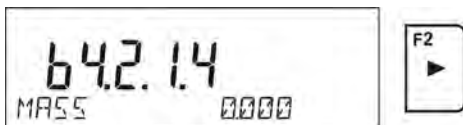

### 15.3. Tares

**TARES** – 100 different masses of the packaging. The following data can be inserted for each packaging: NAME (30 characters), TARE (mass of the packaging, enter the value with the accuracy of balance reading unit).

In order to add tare – mass of the packaging, enter the tare database and insert a name for the tare (follow the procedure as in the section above).



Next, insert the details about the packaging.



#### 15.4. Weighments

**Weighments database** is non-editable i.e. the data relating to the weighments is saved automatically. A user has a possibility of viewing this data and printing it out or exporting to PENDRIVE; if such a need occurs (procedure is described further on in this manual).

The balance software allows you to save and store up to 1000 measurements carried out on the balance. This occurs automatically, after a single press of the button <PRINT>, without a need of additional actions or settings change.

The additional data is saved along with the measurement.

- Date of the measurement
- Date of the measurement
- Measurement result (mass)
- Tare value
- Name of the product that has been weighed
- Person carrying out the measurement (logged-in user)
- Working mode in which the measurement has been carried out
- Value of variable 1 and 2

The software saves the measurements in a so called loop, i.e. when the measurement 1001 is saved, the measurement 1 is automatically deleted from the balance's memory.



**The measurements saved in the balance's memory cannot be deleted.**

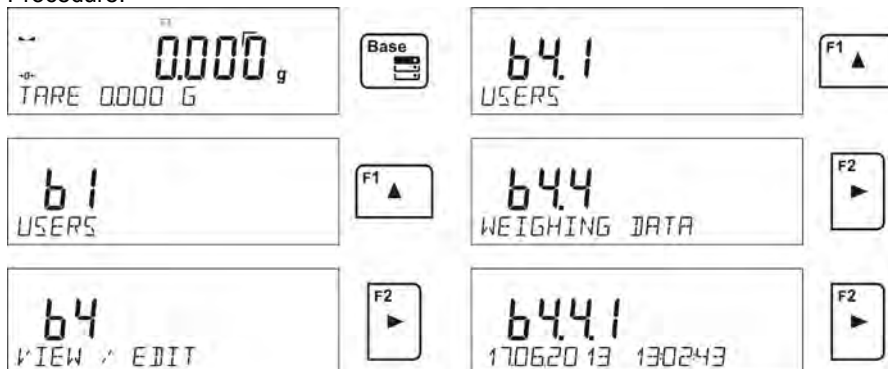

It is possible for a user to view and print out the data saved in the memory.

Procedure:



Each measurement is saved with its individual number. The format is: b4.4.n, where <n> is the consecutive number of the saved measurement. In the bottom line the date and time are displayed for every single measurement.

To move through the saved measurements database, use the arrow

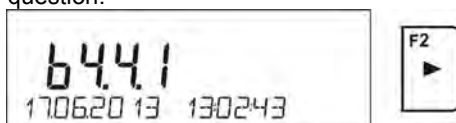

buttons  or . To move to the next measurement either up or down the list, press one of the buttons.

To view the remaining data relating to the measurement, press  after selecting the measurement in question:

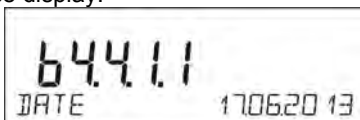

The software will automatically show the data relating to the measurement in the bottom line of the balance display.



To move through the data relating to the measurement, press  or . The data relating to the measurement can be printed out by selecting the option

<PRINT> and pressing  button.

644.11  
DATE 170620 13

645.16  
USERS NOWAK J.

644.12  
TIME 130243

645.17  
WORKING MODES WEIGH

644.13  
RESULT 10.718 G



645.18  
VARIABLE 1 1234



644.14  
TARE 0000 G

645.19  
VARIABLE 2 5678

644.15  
PRODUCT TABLET

645.110  
PRINT



Example of a printout

Date 21.06.2013  
Time 13:05:02  
User  
Product

Tare 0.000 g  
Gross 0.000 g  
0.000 g

-----Cal. report.-----

Cal. type Internal  
User  
Project 1234567890123459  
Date 16.07.2013  
Time 13:27:09  
Balance ID 10353870  
Cal. diff. -0.004 g

Signature  
.....

The data that is to be printed out, depends on the settings in parameter P5.3 GLP PRINTOUT. Depending on what data is set in this parameter for the print-out (by selecting <YES>) the data is printed out also in WEIGHTMENTS database (see sec. 13.3.)

## 15.5. ALIBI

The balance is equipped with “ALIBI”, a type of memory that allows you to save and store up to 100 000 measurements carried out on the balance.

If the “ALIBI” memory is installed in the balance, the saving of the measurements occurs automatically, by pressing <PRINT> button, without a need of additional actions or settings change.

The additional data is saved along with the measurement.

- Date of the measurement
- Time of the measurement
- Measurement result (mass)
- Tare value
- Person carrying out the measurement (logged-in user)
- The name of the product that has been weighed

The software saves the measurements in a so called loop, i.e. when the measurement 1001 is saved, the measurement 1 is automatically deleted from the balance’s memory.



**The measurements saved in the balance’s memory cannot be deleted.**

It is possible for a user to view and print out the data saved in the “ALIBI” memory.

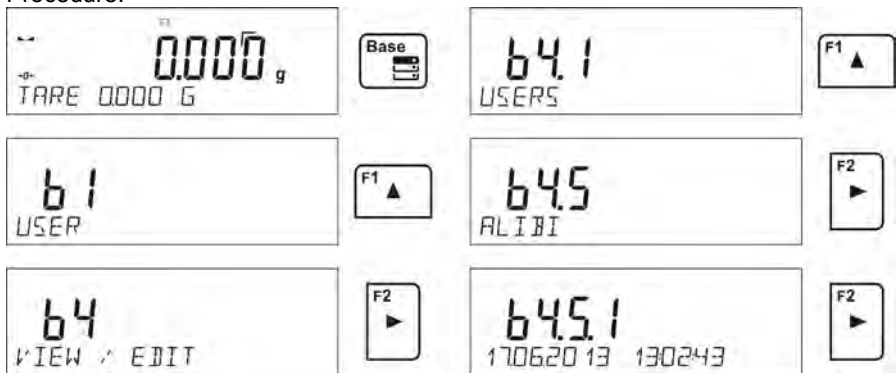
Procedure:



Each measurement is saved with its individual number. The format is: b4.5.n, where <n> is the consecutive number of the saved measurement. In the bottom line the date and time are displayed for every single measurement.

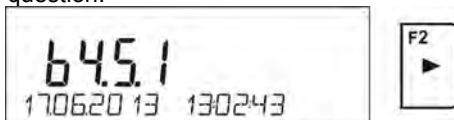

To move through the saved measurements database, use the arrow  or . To move to the next measurement either up or down the list, press one of the buttons.

To view the remaining data relating to the measurement, press  after selecting the measurement in question:

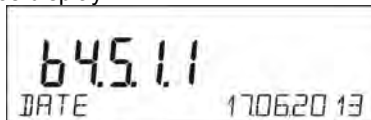

The software will automatically show the data relating to the measurement in the bottom line of the balance display.



To move through the data relating to the measurement, press  or . The data relating to the measurement can be printed out by selecting the option

<PRINT> and pressing  button.

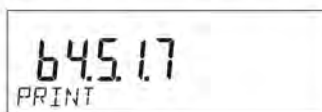
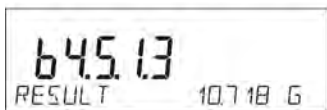
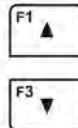
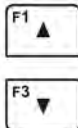
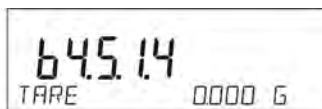
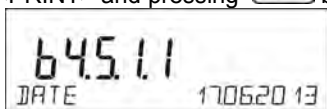

Example of a print-out

Date 19.06.2013  
Time 6:48:41  
Result 199.90 g  
Tare 0.000 g  
User SMITH  
Product PILL

To return to the weighing mode press  button repeatedly.

## 16. EXPORT AND IMPORT OF DATABASE

This option allows you to:

- Archive the data relating to the weighments carried out– WEIGHMENT database and ALIBI database
- Copy the products databases and tares databases between the balances of this series

This can be accomplished by using external memory PENDRIVE.  
Plug a PENDRIVE in USB 1 – TYPE A port if you want to use this option.

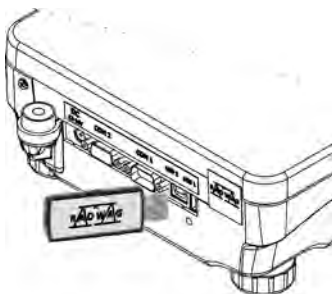

The balance automatically sees the external memory drive and the message enabling operations relating to the export or import of the database is displayed.

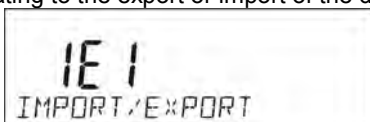

The following options are available when entering this parameter:

- EXPORT database



- IMPORT database

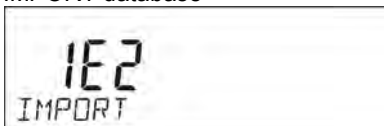

## 16.1. Export database

To export the database, enter the option EXPORT.



The following functions are available:

- Export of all the databases
- Export of users databases
- Export of product databases
- Export of tares databases
- Export of weighments
- Export of weighments saved in ALIBI memory
- Export of users parameters

After selecting the option <ALL DATABASES>, the balance software creates files on the PENDRIVE. The files are of relevant names and are saved in individual databases. The files have special extensions and the data saved in them is encoded in a way that the files cannot be read or seen in standard computer programs.

Special computer softwares manufactured by RADWAG company are used to read the data from the database files: ALIBI and WEIGHMENTS. The data from the files, in which the data from the PRODUCTS, USERS, and TARES databases is saved, is read automatically by the balance software in the option <IMPORT>.

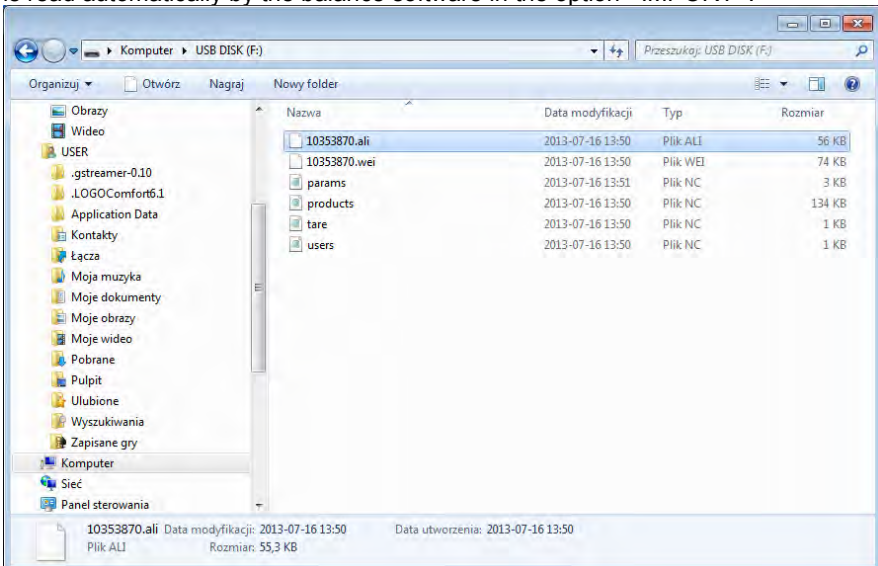

## 16.2. Import database

The function <IMPORT> allows you, amongst others, to transfer the data saved in the balance database. In this balance, the data to be entered in the new balance is entered. This is a quick and reliable way to enter the data without any mistakes.

To import the database, plug a PENDRIVE in USB port and next select IMPORT and choose one of the following options



The following options are available:

- Import of all databases
- Import of users databases
- Import of products databases
- Import of tares databases
- Import users parameters

The data from the ALIBI and WEIGHMENTS databases cannot be imported.

## 16.3. Measurement data print-out



The balance software allows you to save the data relating to the measurement on the external memory - PENDRIVE.

The operation can be performed as follows:

- Plug a pendrive in USB port
- Abandon <IMPORT/EXPORT> option, which is automatically started by



pressing button

- In the parameter P4.2.1 <DEVICES/PRINTER/PORT> set the option <PENDRIVE>
- Return to the weighing mode
- From this moment on, every single pressing of the button  leads to the saving the measurement data (compatible with the settings for GLP0 PRINTOUT) in a text file, which is automatically created by the balance software. The file name is: *printout.txt*.
- Turn the balance off by pressing  button so that the data is saved in the file. Only then can you remove the pendrive from the port and read the data on a computer.

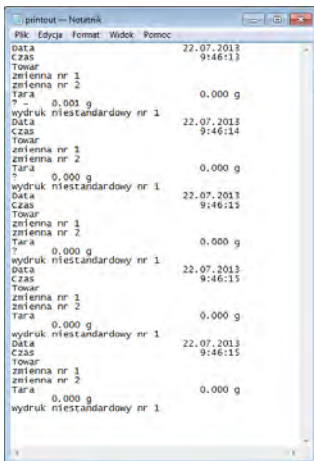
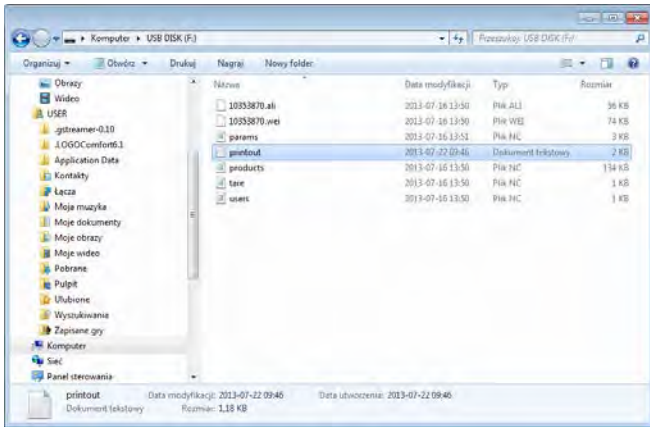

The data can be printed out on any printer connected to the computer.

More data can be saved in the same file. The balance software will add the date in the file that has already been created on the pendrive. Consequently, a user can continue with saving the measurements in the same file once created.

**ATTENTION:**  
 When the balance software sees the PENDRIVE, the menu <P8 IMPORT/EXPORT> is accessible.  
 All the operations relating to export and import that are described above can be performed using this menu.



## 17. BALANCE WORKING MODES

- Weighments
- Counting pieces
- Checkweighing
- Dosing
- Deviations % against the mass of the standard
- Animal weighing
- Density determination of solids
- Density determination of liquids
- Statistics
- Totalising
- Peak hold

In order to initiate a particular mode press  button, and follow by selecting the mode from the list.

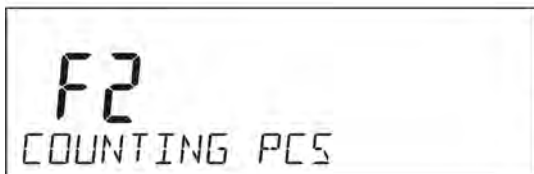

Once the button  has been pressed, the name of the first available function is shown.

 or  - select the working mode

 - enter the selected working mode

The setup for the functions is described further in this manual.

### 17.1. Setup for availability of working modes

In this group of parameters, a user declares functions which are to be available for the user after pressing  button.

It is possible for a user to switch off the functions that are not used during working with the balance. This can be done by setting the availability parameter to <NO>.

Follow the scheme shown below:

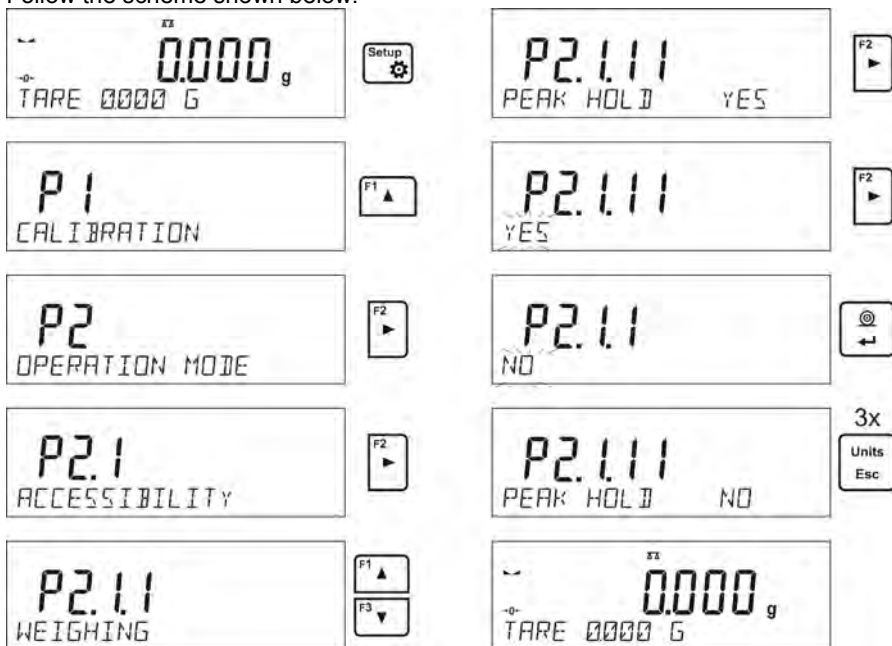

## 17.2. Counting parts of the same mass

The balance, in the standard version, is equipped with the option of counting small objects of the same mass.

- Start Counting Pieces function



When the function is initiated for the first time, the standard mass equals 0.0000g. If the sample mass is determined and has been used in the mode <**COUNTING PIECES**> then the software accepts the mass of recently used standard as the standard mass.

## Setup for mode COUNTING PIECES

The software allows entering settings for each working mode. Some the settings are identical in all working modes. They are described in section relating to the mode <WEIGHING>.

This section covers only the settings relating to the mode <COUNTING PIECES>.

### F button shortcuts

The function enables the option of quick access for weighing functions, which are available when buttons F1, F2, F3 or F4 are pressed.

In the mode <COUNTING PIECES> the following options are available, which a user can assign to each of the **F** buttons:

**NONE** – no function assigned to the button

**ENTER SAMPLE** – function initiates the option of entering the reference mass of a single piece

**DETERMINE SAMPLE** – function initiates the option of automatic determination of the mass of a single piece from a number of samples of known quantity

**SELECT PRODUCT** – function initiates the option of selecting a product from product database

**LOG IN** – function initiates the option of selecting and logging-in of a balance's user

**ENTER TARE** – function initiates the option of inserting packaging mass

**SELECT TARE** – function initiates the option of selecting packaging mass from product database

**PRINT HEADER** – function initiates the print-out of a designed header

**PRINT FOOTER** – function initiates the print-out of a designed footer

**VARIABLE 1** – function initiates the selection and editing of variable 1

**VARIABLE 2** – function initiates the selection and editing of variable 2

*The way of declaring the function is described in the section relating to the weighing mode settings <F button shortcuts>.*

## Setting the reference mass by determining from the sample of known quantity

While determining the mass of a single piece the function **ACAI** (Automatic Accuracy Correction) is in use.



### Means of operation of ACAI function:

- Number of pieces (on adding) on balance's weighing pan has to be greater than has been previously
- Number of pieces (on adding) on balance's weighing pan must be less than twice the amount of which was visible on the display before adding parts
- Current quantity of parts must be within the  $\pm 0,3$  tolerance of the total value,
- Measurement result has to be stabilised.

### Procedure:

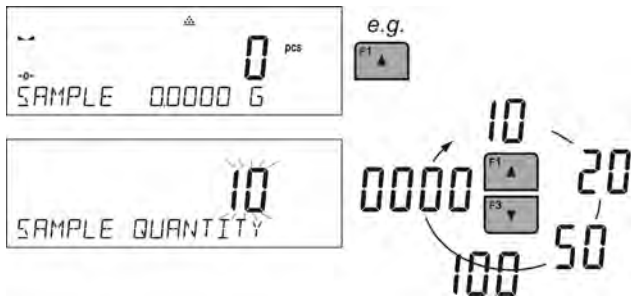
- Place the container on the pan and tare its mass,
- Press one of the F buttons, to which the function **<ENTER SAMPLE>** is assigned, and the editing window **<SAMPLE QUANTITY>** is displayed



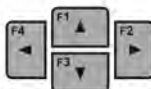
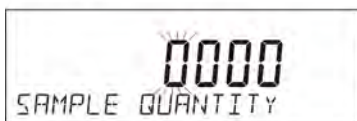

- Use the navigating buttons  or  to select the correct sample quantity.
- For the option: any quantity (displayed value <0000> enter a numer using navigating buttons).



- Zatwierdzić wybraną licznosc próbki, zostanie wyświetlony komunikat <PLACE<sub>xx</sub> PCS>.





- Place the declared number of pieces in the container and when the result is stable (the symbol  is displayed) and confirm their mass by pressing  button,
- The balance software automatically counts a single sample mass and enters the mode <COUNTING PIECES> displaying the number of pieces which are on the pan (pcs). In the bottom line, a single sample mass value is shown (if the option for the function <INFORMATION> has been selected).



**ATTENTION:**

*It should be remembered that:*

- The total mass of all the pieces put on the weighing pan must not be greater than the balance's maximum weighing range.
- The mass of a single piece cannot be lower than the **0,1 reading unit** of the balance. If this condition is not met, the balance displays the message: **<Too low sample mass>**.
- While determining the number of pieces, wait for the stability pictogram , in order to confirm the quantity.
- Only after the stability pictogram is displayed can you confirm the declared quantity by pressing  button. Otherwise, the balance will not accept the measurement.

## Setting the reference mass by entering its mass

### Procedure:

- Press one of the F buttons, to which the function **<ENTER SAMPLE>** is assigned, and the editing window **<ENTER SAMPLE>** is displayed

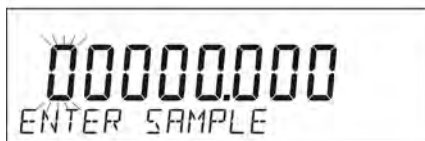

- Use the arrow buttons to insert the known a single sample mass value.



- Confirm the entered mass by pressing  button,

- The balance software automatically counts a single sample mass and enters the mode <COUNTING PIECES> displaying the number of pieces which are on the pan (**pcs**). In the bottom line, a single sample mass value is shown (if the option for the function <INFORMATION> has been selected).



**Returning to the weighing mode**





### 17.3. Checkweighing

Checkweighing is a working mode that uses two thresholds (LOW and HIGH) in order to check the mass of the samples. It is generally assumed that the mass is correct if it is contained within the threshold values.

#### **F button shortcuts**

The function enables the option of quick access for weighing functions, which are available when buttons F1, F2, F3 or F4 are pressed.

In the mode <**CHECKWEIGHING**> the following options are available, which a user can assign to each of the **F** buttons:

**NONE** – no function assigned to the button

**ASSIGN THRESHOLDS** – function initiates the option of ascribing thresholds for the checkweighing

**SELECT PRODUCT** – function initiates the option of selecting a product from product database

**LOG IN** – function initiates the option of selecting and logging-in of a balance's user

**ENTER TARE** – function initiates the option of inserting packaging mass

**SELECT TARE** – function initiates the option of selecting packaging mass from product database

**PRINT HEADER** – function initiates the print-out of a designed header

**PRINT FOOTER** – function initiates the print-out of a designed footer

**VARIABLE 1** – function initiates the selection and editing of variable 1

**VARIABLE 2** – function initiates the selection and editing of variable 2

*The way of declaring the function is described in the section relating to the weighing mode settings <F button shortcuts>.*

## Declaration of mass thresholds

### Procedure:

- Press one of the F buttons, to which the function <**ASSIGN THRESHOLDS**> is assigned, the editing window is displayed and the value of MIN low threshold can be ascribed.



- Use the arrow buttons to ascribe the value of the low threshold



- Confirm the inserted value by pressing  button,
- The software automatically proceeds to the edit of MAX high threshold

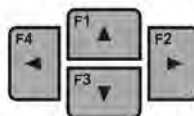

- Confirm the inserted mass by pressing  button,
- The balance software proceeds to the mode **<CHECKWEIGHING>** and states the values of declared thresholds in the bottom line (if such an option for the function **<INFORMATION>** has been selected).
- At the top of the display the message **<Min>** is shown, which indicates the value of the mass on the weighing pan is below the low threshold mass value.

|  |   |
|--|---|
|  | <p><b>&lt;Min&gt;</b>: mass lower than the value of the low threshold</p>   |
|  | <p><b>&lt;Ok&gt;</b>: mass contained within thresholds</p>                  |
|  | <p><b>&lt;Max&gt;</b>: mass higher than the value of the high threshold</p> |

## 17.4. Dosing

The dosing is the mode which consists in the process of sample weighing until target mass is reached. The target mass is defined along with dosing tolerance. Tolerance value is set as a percentage of the target mass, entering the value percentage.

**Example:**

*Target weight = 100.000g*

*Tolerance = 2,5% (2,5% of 100g, which amounts to 2,5g)*

*i.e.: the software accepts correctly dosed value within the following thresholds: from 97,500g to 102,500g.*

### F button shortcuts

The function enables the option of quick access for weighing functions, which are available when buttons F1, F2, F3 or F4 are pressed.

In the mode <**DOSING**> the following options are available, which a user can assign to each of the **F** buttons:

**NONE** – no function assigned to the button

**ENTER SAMPLE**– function initiates the option of entering the reference mass along with tolerance (one procedure)

**SELECT PRODUCT** – function initiates the option of selecting a product from product database

**LOG IN** – function initiates the option of selecting and logging-in of a balance's user

**ENTER TARE** – function initiates the option of inserting packaging mass

**SELECT TARE** – function initiates the option of selecting packaging mass from product database

**PRINT HEADER** – function initiates the print-out of a designed header

**PRINT FOOTER** – function initiates the print-out of a designed footer

**VARIABLE 1** – function initiates the selection and editing of variable 1

**VARIABLE 2** – function initiates the selection and editing of variable 2

*The way of declaring the function is described in the section relating to the weighing mode settings <F button shortcuts>.*

## Setting a target weight by entering values

### Procedure:

- Press one of the F buttons, to which the function <ENTER SAMPLE> is assigned, and the editing window <ENTER SAMPLE> is displayed

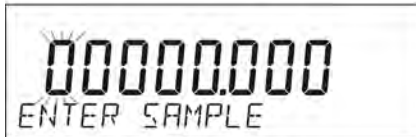

- Use the arrow buttons to enter the target weight

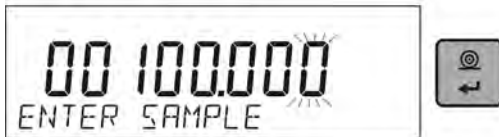

- Confirm the inserted target weight by pressing  button,
- The software automatically sets tolerance of target mass dosing.

- Use the arrow buttons to set the tolerance value



- Confirm the entered tolerance by pressing  button,

- The balance software automatically enters the mode **<DOSING>** and displays the target mass value with a minus sign, and in the bottom line standard mass value – target mass (if such option for the function **<INFORMATION>** was selected).



- The sign **<Min>** is shown at the top of the display. It indicates the status of the mass on the pan with relations to the target mass, below the value **<TARGET MASS – TOLERANCE>**

|  |  |
|--|--|
|  | <p><b>&lt;Min&gt;</b>: mass lower than the Target Value - Tolerance</p>                  |
|  | <p><b>&lt;Ok&gt;</b>: mass contained within tolerance<br/>Target Value +/- Tolerance</p> |
|  | <p><b>&lt;Max&gt;</b>: mass higher than the Target Value + Tolerance</p>                 |

## Returning to the weighing mode



### 17.5. Deviations % against the mass of the standard

The balance software has the option of deviation control (in percentage) between weighed loads mass samples and the reference mass standard. The mass of the standard can be determined by its weightment or by typing into the balance's memory by its user.

#### F button shortcuts

The function enables the option of quick access for weighing functions, which are available when buttons F1, F2, F3 or F4 are pressed.

In the mode **<DEVIATIONS>** the following options are available, which a user can assign to each of the **F** buttons:

**NONE** – no function assigned to the button

**ENTER SAMPLE**– function initiates the option of entering reference mass to control mass deviation

**DETERMINE SAMPLE** – function initiates the option of entering reference mass to control mass deviation

**SELECT PRODUCT** – function initiates the option of selecting a product from product database

**LOG IN** – function initiates the option of selecting and logging-in of a balance's user

**ENTER TARE** – function initiates the option of inserting packaging mass

**SELECT TARE** – function initiates the option of selecting packaging mass from product database

**PRINT HEADER** – function initiates the print-out of a designed header

**PRINT FOOTER** – function initiates the print-out of a designed footer

**VARIABLE 1** – function initiates the selection and editing of variable 1

**VARIABLE 2** – function initiates the selection and editing of variable 2

*The way of declaring the function is described in the section relating to the weighing mode settings <F button shortcuts>.*

### Setup for reference mass determined by weighing

#### Procedure:

- Press one of the F buttons, to which the function <**DETERMINE SAMPLE**> is assigned and the editing window will be displayed <**PLACE 100%**>



- Place the standard (as 100%) on the pan, and when the result is stable

(  symbol is displayed) confirm the mass by pressing



- The balance program automatically enters the load value to be measured as a standard and enters the mode <**DEVIATIONS**> displaying the value of 100.000%, and the bottom line displays standard mass value (if the option for function <**INFORMATION**> is selected).





## Setup for reference mass by typing its mass

### Procedure:

- Press one of the F buttons to which the function <ENTER SAMPLE> is assigned and the editing window will be displayed <ENTER SAMPLE>

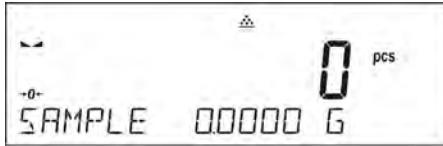

e.g.

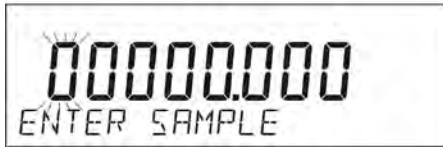

- Using the arrow buttons enter the known reference mass.

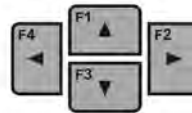
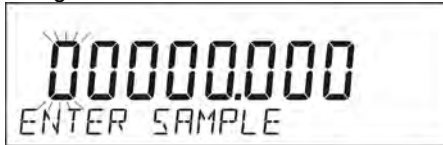

- Confirm by pressing  button,
- The balance software automatically proceeds to the mode <DEVIATIONS> displaying the value of 0.000%, and the bottom line displays the entered value of the standard mass (if the option for function <INFORMATION> is selected).



## Returning to the weighing mode



## 17.6. Animal weighing

Working mode <Animal weighing> enables reliable determining mass of objects in motion. In principle, these types of objects generate unstable measurement, thus it requires using a different filtering method of measurement signal.

### Additional setting for animal weighing mode

Apart from the standard settings for this mode (described in the weighing mode), additional settings have been introduced which describe the operation of the mode.

Available options:

- **AVERAGING TIME** – Amount of time during which measurement records of weighed sample are analysed. Obtained data is used to determine measurement result
- **THRESHOLD** - It is a value expressed in mass measuring units. In order to start measurement, the indication has to exceed value set in the threshold.
- **AUTOSTART** - Determines start criterion for measurements: whether they are initiated manually / on pressing a button or selecting START/ or automatically.

When set on <YES> a measurement starts automatically if indication on balance's display exceeds the value of set threshold. The following measurement can start on unloading the weighed object from balance's pan (the indication has to return below the value set in threshold) loading a new object on the pan and exceeding the threshold's value by the indication.

It should be remembered, however, that before the start of the animal weighing the above-mentioned options should be set on the appropriate values to meet the expectations and the needs of the working conditions.

## **F button shortcuts**

The function enables the option of quick access for weighing functions, which are available when buttons F1, F2, F3 or F4 are pressed.

In the mode **<ANIMAL WEIGHING>** the following options are available, which a user can assign to each of the **F** buttons:

**NONE** – no function assigned to the button

**START** – function initiates the start of the weighing of the object place on the weighing pan in the manual mode (AUTOSTART parameter set on NO value)

**SELECT PRODUCT** – function initiates the option of selecting a product from product database

**LOG IN** – function initiates the option of selecting and logging-in of a balance's user

**ENTER TARE** – function initiates the option of inserting packaging mass

**SELECT TARE** – function initiates the option of selecting packaging mass from product database

**PRINT HEADER** – function initiates the print-out of a designed header

**PRINT FOOTER** –function initiates the print-out of a designed footer

**VARIABLE 1** – function initiates the selection and editing of variable 1

**VARIABLE 2** – function initiates the selection and editing of variable 2

*The way of declaring the function is described in the section relating to the weighing mode settings <F button shortcuts>.*

## Method of operation to manually start the process

To manually start the process of weighing select the option <AUTOSTART> and <NO> in the mode settings.

Procedure:



After altering the setting, return to the main window by pressing  button repeatedly.

Next, set the averaging time in seconds. It is the time, during which the balance software collects measurements and based on these measurements the average result is determined.

The parameter <THRESHOLD> is not required for this measurement mode.

Select the mode <ANIMAL WEIGHING>.

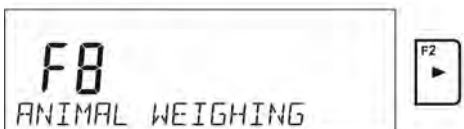

Place the container in which the measurement is to be carried out on the weighing pan and when the indication is stable tare its mass.

Next, enter the mode options and start the measurement procedure following the diagram below.

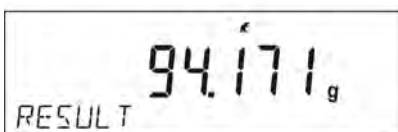
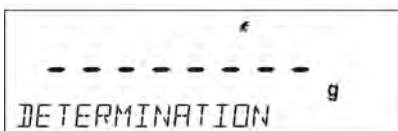

After finalising the weighing process measurement result is locked and automatically printed.



In order to finish the measurement press  button.  
The program automatically returns to the main window mode.

### **Method of operation to automatically start the process**

In order to start the process of weighing in manual mode, select <AUTOSTART> <YES> in the settings module as described in the previous paragraph. Additionally, the parameters <AVERAGING TIME> and <THRESHOLD> should be set.

For this working mode, in order to carry out the measurement in a container (TARE), select the option <ENTER TARE> which is described in the options relating to weighing.

To start the process (after setting the options), enter the weight of the container, then put the container on the pan and place the object that is being weighed in the container. The balance automatically begins the process of measurement after exceeding the set threshold mass.

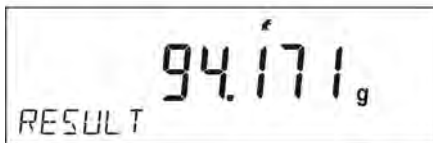
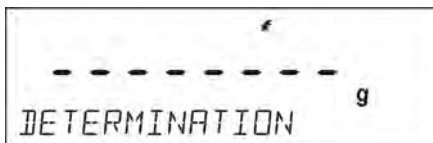

After finalising the weighing process measurement result is locked and automatically printed.



In order to finish the measurement press  button.  
The program automatically returns to the main window mode.



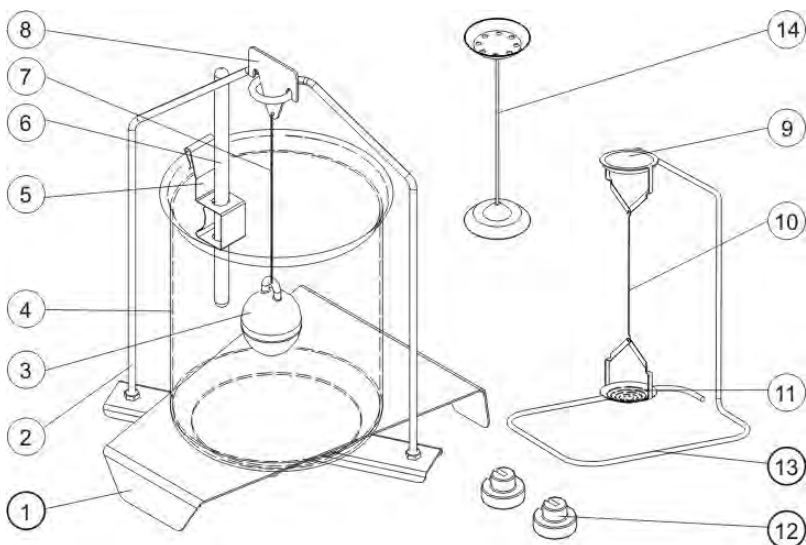

The kit suitable for AS balances.

#### Components of the kit:

|   |                           |    |  |
|---|---------------------------|----|--|
| 1 | Beaker basis              | 8  | Hook   |
| 2 | Weighing pan stand        | 9  | Top weighing pan of density determining kit for solids   |
| 3 | Sinker                    | 10 | Weighing pans flexible connector   |
| 4 | Beaker                    | 11 | Bottom weighing pan of density determining kit for solids  |
| 5 | Thermometer handle        | 12 | Additional weight  |
| 6 | Thermometer               | 13 | Additional stand for set of pans or a sinker   |
| 7 | Sinker flexible connector | 14 | Additional set of pans for determining density of solids whose density is lower than density of water. |

#### NOTE:

- The kit components should be stored in the kit,
- The set of pans or the sinker components should not be put on the table top as it may damage them,
- If the set of pans or the sinker are not used, they should be put on an additional stand,
- If after installing the set there is NULL message on the display, you need to load the set with weights (12). The balance prepared in this way can be used for density determination.



## **F button shortcuts**

The function enables the option of quick access for weighing functions, which are available when buttons F1, F2, F3 or F4 are pressed.

In the mode <**DENSITY OF SOLIDS**> and <**DENSITY OF LIQUIDS**> there are options which a user can assign to each of the **F** buttons:

**NONE** – no function assigned to the button

**START** – function initiates the density determination option

**SELECT PRODUCT** – function initiates the option of selecting a product from product database

**LOG IN** – function initiates the option of selecting and logging-in of a balance's user

**INSERT TARE** – function initiates the option of inserting packaging mass

**SELECT TARE** – function initiates the option of selecting packaging mass from product database

**PRINT HEADER** – function initiates the print-out of a designed header

**PRINT FOOTER** – function initiates the print-out of a designed footer

**VARIABLE 1** – function initiates the selection and editing of variable 1

**VARIABLE 2** – function initiates the selection and editing of variable 2

*The way of declaring the function is described in the section relating to the weighing mode settings <F button shortcuts>.*

## Density determination of solids

Density determination of solids can be carried out in two pre-defined types of liquids or user-defined liquid with specified density:

- **WATER** (distilled water),
- **ETHANOL** (spirit 100% +/- 0.1% in temp. 20<sup>o</sup>C),
- **ANOTHER** (another liquid with specified density).

In case of determining density in water or alcohol it is necessary to specify their temperature. For another liquid, its value (density) is inserted from balance keyboard. Density determination is carried out by weighing a sample first in the air (top weighing pan (4) of the density kit), and then weighing the same sample in liquid (on the bottom weighing pan (2) of the density kit). As the same sample is weighed in liquid, the result of density determination is automatically indicated on balance display.

In order to determine the density you need to:

1. Instal the density determination kit,
2. Enter <DENSITY OF SOLIDS> function



3. Prepare a sample,
4. Initiate the process

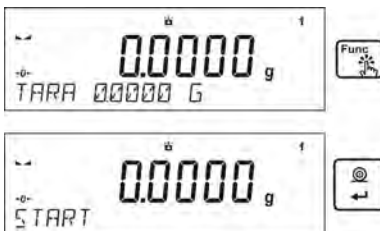

5. Insert the settings for the process following the displayed messages,
6. Liquid in which the determination is carried out

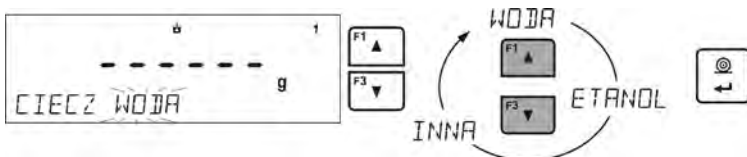

- After selecting and entering a liquid type by pressing <ENTER> button, the program will take another step, namely setting the temperature



- If <ANOTHER> liquid of determined density has been chosen, you should insert its density



- After inserting this data, the program will pass on to the proper measuring process,
- First, a mass sample should be placed on the top weighing pan of the kit (weighing in the air), and after the indication stabilization the result is approved



11. Next, a mass sample should be placed on the bottom pan of the kit (mass determination in the liquid), and after the indication stabilization, approve the result



12. On the second measurement result approval, the program will automatically calculate the tested solid object density and it will be indicated on a balance display. At the same time, the measuring report will be sent to a selected printer port

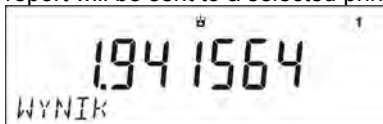



Example of a report:

```

----- Density of solids -----
Date                27.08.2013
Time                13:35:19
Balance ID          321000000
User                ADMIN
Liquid              Water
Temperature         23,0°C
Liquid density      0.99756 g/cm3
Weighed in the air  5.0355 g
Weighed in liquid   2.4483 g
Density             1.941564 g/cm3
.....
Signature
-----

```

Another copy of the report can be printed out on pressing  button. In order to

finish the process, press  button. The program returns to the main function window. You can start another measurement. The balance remembers the recently inserted data (liquid, temperature), which shortens the measuring procedure considerably.

## 17.8. Density of liquid

**Density of liquid** function enables determination of any liquid density. Using this function requires an additional kit for density determination (optional equipment). It is the same kit like for determination of solids density (description above).

Settings for button shortcuts are the same as for <SOLIDS DENSITY> function (see the previous point).

### 17.8.1. Density of liquids determination

The basic element for measuring the density of liquids is the sinker (9). Its volume is precisely determined and given on a sinker's hanger. Before starting liquid density determination, insert the value of sinker's volume to balance memory. In order to measure the density of liquid, first determine mass of the sinker in the air. Then, measure mass of the same sinker in tested liquid. The result of liquid density determination is automatically indicated on balance display.

In order to determine the liquid density you need to:

1. Instal the density determination kit,
2. Enter <DENSITY OF LIQUIDS> function

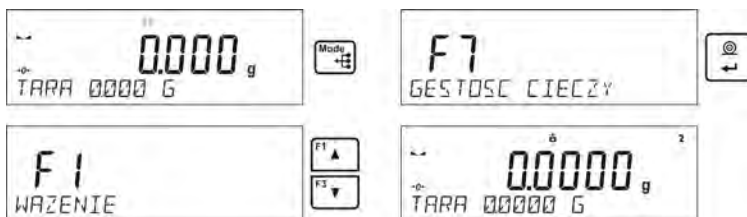

3. Prepare a sample,
4. Initiate the process (like in case of solids density determination),
5. Insert the settings for the process following the displayed messages,
6. Volume of the sinker used for measuring



7. On inserting the data, the program will pass on to the proper process of measuring.
8. First, the sinker should be placed on the hook (a sample mass determination in the air), and after the indication stabilization the measurement result is approved



9. Next, take the sinker out of the hook and put the tested sample with liquid on the beaker's basis (the beaker cannot touch the hook). Delicately hang the sinker on the hook (the sinker must be totally emerged in the tested liquid) – a mass sample determination in liquid – and after the indication stabilization approve the result.

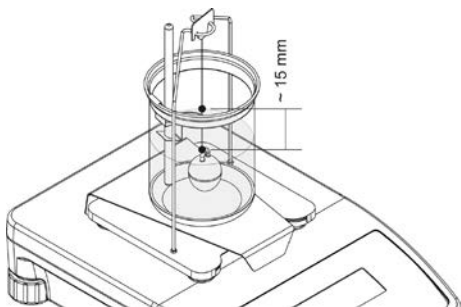





10. On the second measurement result approval, the program will automatically calculate density of the tested liquid which will be indicated on the display. The measuring report will be sent to a selected printer port



Example of a report:

Density of liquid  
Date  
Time  
Balance ID  
User  
Sinker volume  
Weighed in the air  
Weighed in liquid  
Density  
  
Signature

Another copy of the report can be printed out on pressing  button. In order to

finish the process, press  button. The program returns to the main function window. You can start another measurement. The balance remembers the recently inserted data (the sinker volume), which shortens the proper measuring procedure starting time considerably.

## 17.9. Statistics

Statistics allows you to collect data of the series of measurements and use them to generate statistics. The range of statistics data created depends on the setting of internal functions.

### **F button shortcuts**

The function enables the option of quick access for weighing functions, which are available when buttons F1, F2, F3 or F4 are pressed.

In the mode **<STATISTICS>** the following options are available, which a user can assign to each of the **F** buttons:

**NONE** – no function assigned to the button

**RESULT** – function enables viewing statistics results for the particular series of measurements

**FINISH** – selecting this option finishes the series of measurements, once selected, the statistics for the particular series of measurements is deleted

**SELECT PRODUCT** – function initiates the option of selecting a product from product database

**LOG IN** – function initiates the option of selecting and logging-in of a balance's user

**ENTER TARE** – function initiates the option of inserting packaging mass

**SELECT TARE** – function initiates the option of selecting packaging mass from product database

**PRINT HEADER** – function initiates the print-out of a designed header

**PRINT FOOTER** – function initiates the print-out of a designed footer

**VARIABLE 1** – function initiates the selection and editing of variable 1

**VARIABLE 2** – function initiates the selection and editing of variable 2

*The way of declaring the function is described in the section relating to the weighing mode settings <F button shortcuts>.*



## Statistical data that is counted for every measuring series

- N (number of samples)
- SUM (total number of samples)
- AVG (average value in a series)
- MIN (minimal value in a series)
- MAX (maximal value in a series)
- SDV (standard deviation)
- DIF (difference between MAX and MIN in a series)
- SDV (standard deviation in a series)
- RDV (variation coefficient)

### 17.9.1. Means of operation

- Enter the mode <STATISTICS>

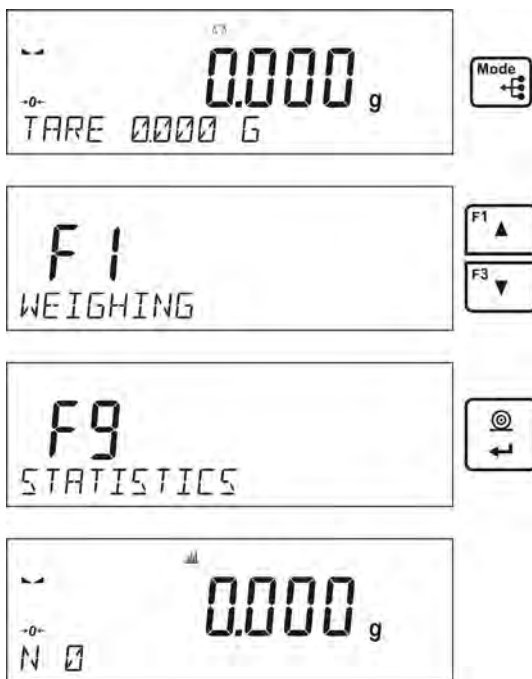

- Place the first load on the weighing pan



- When the indication is stable, confirm the measurement by pressing  button,
- The measurement is saved in the balance memory and is automatically printed out with the measurement number.
- Remove the load from the weighing pan
- Carry out measurements for other loads within this series



When all the measurements are saved, it is possible to check the results

of the statistics by pressing  button:



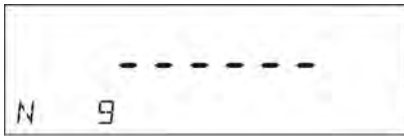

Select the option <RESULT> by pressing  button.



```

N 9
SUM 455600 G
AVG 506222 G
MIN 49939 G
MAX 51380 G
DIF 1441 G
SDV 039605 G
RDV 078 %
BRUKUJ
  
```

The information about the number of saved measurements is displayed in the bottom line. On pressing  or , the type of the information displayed changes.



Selecting the option <PRINT> and pressing  button initiates printing out the statistics data as a report.

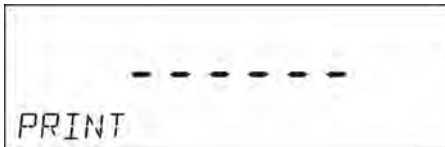

*Example of a report:*

| ----- Statistics ----- |           |
|------------------------|-----------|
| N                      | 9         |
| Sum                    | 455.600 g |
| Avg                    | 50.6222 g |
| Min                    | 49.939 g  |
| Max                    | 51.380 g  |
| Dif                    | 1.441 g   |
| Sdv                    | 0.39605 g |
| Rdv                    | 0.78 %    |
| -----                  |           |

### 17.9.2. Deleting statistics

To delete the statistics data carried out for the series of measurements, you should follow this procedure:

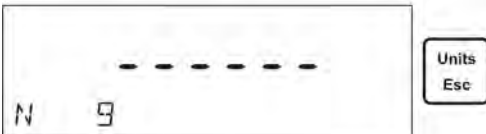

Activating the option <FINISH> results in printing out the statistics data and moving to the window <RESULT>, from which it is possible to check the data and print it out again, if necessary.

Abandon this window by pressing  button. This leads to returning to the main mode <STATISTICS> and zeroing the data related to the carried out measurements.



A user can begin another series of measurements or return to the mode of weighing.

### 17.9.3. Returning to the weighing mode

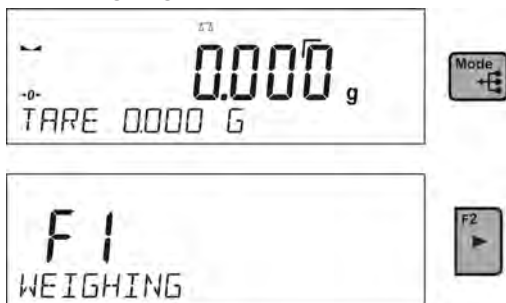

## 17.10. Totalising

The function Totalising allows a user to weigh individual ingredients of the mixture and totalising their total mass. The software enables adding up approximately 30 ingredients in one mixture.

### F button shortcuts

The function enables the option of quick access for weighing functions, which are available when buttons F1, F2, F3 or F4 are pressed.

In the mode <**TOTALISING**> the following options are available, which a user can assign to each of the **F** buttons:

**NONE** – no function assigned to the button

**FINISH** – selecting this option finalises totalising of the ingredients within one procedure; once selected, it prints out the summary and deletes the data relating to the carried out totalising procedure

**DELETE LAST** – selecting this option causes subtracting recently added mass from the total mass of the mixture

**SELECT PRODUCT** – function initiates the option of selecting a product from product database

**LOG IN** – function initiates the option of selecting and logging-in of a balance's user

**ENTER TARE** – function initiates the option of inserting packaging mass

**SELECT TARE** – function initiates the option of selecting packaging mass from product database

**PRINT HEADER** – function initiates the print-out of a designed header

**PRINT FOOTER** – function initiates the print-out of a designed footer

**VARIABLE 1** – function initiates the selection and editing of variable 1

**VARIABLE 2** – function initiates the selection and editing of variable 2

*The way of declaring the function is described in the section relating to the weighing mode settings <F button shortcuts>.*

### 17.10.1. Means of operation

- Enter the mode <TOTALISING>



The bottom line shows the data relating to the number of ingredients which are added to the total sum (if such information is selected in the settings for totalising mode).

- Place a container on the weighing pan, in which the ingredients are to be weighed and tare its mass. Next, place the first ingredient in the container and confirm its mass after the indication is stable by pressing



button.



The software adds the mass of the ingredient to the total which is followed by automatic taring of the indication (zero indication is shown on the main display). In the bottom line the data relating to the number of ingredients and total sum is fluctuated.

- Next, place other ingredients in the container and when the indication is stable confirm their mass by pressing  button.
- If a mistake has occurred concerning the mass of the last added ingredient, a user can return to the previous step of the procedure. After changing the mass of the ingredient, it is possible for the user to add this mass to the total. In such a case, follow this procedure:

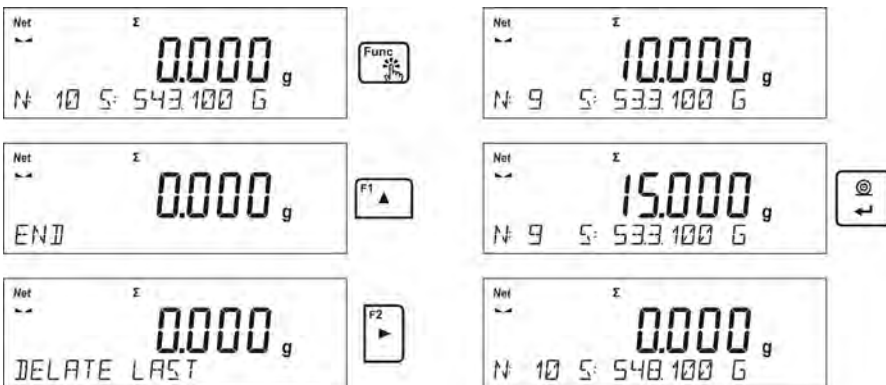

Finish the procedure of totalising when all the ingredients have been weighed.

Procedure:

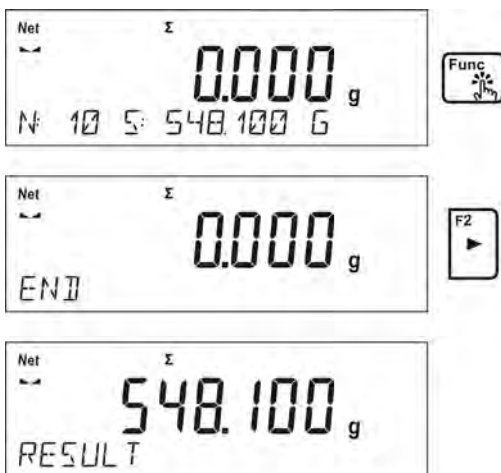

The message <RESULT> is displayed in the bottom line, which means that the total result of all the ingredients that have been weighed are shown on the



main display. Additionally, the end report, in which all the information about the masses of individual ingredients, total sum and mass of the applied tare, is printed out.

*Example of a report:*

| ----- Totalising ----- |         |   |
|------------------------|---------|---|
| 1.                     | 38.000  | g |
| 2.                     | 100.000 | g |
| 3.                     | 50.000  | g |
| 4.                     | 10.000  | g |
| 5.                     | 125.000 | g |
| 6.                     | 15.100  | g |
| 7.                     | 148.000 | g |
| 8.                     | 6.000   | g |
| 9.                     | 41.000  | g |
| 10.                    | 15.000  | g |
| -----                  |         |   |
| Total                  | 548.100 | g |
| Tare                   | 100.000 | g |
| -----                  |         |   |

It is possible to print out the report again by pressing  button.

To abandon this window, press  button. This will cause returning to the main mode <TOTALISING> and it will automatically zero the data related to the carried out measurements.



### 17.10.2. Returning to the weighing mode



## 17.11. Peak hold

This function enables peak hold applied to the weighing pan during a single checkweighing process. Apart from standard settings for this mode (described in the weighing mode), additional setting has been introduced.

The option is available in the settings for mode <PEAK HOLD>

This is:

- **THRESHOLD** – which specifies the starting control point of peak hold on the weighing pan by the balance software. It should be remembered, however, that the peak hold must be set according to the needs before starting the weighing process

### F button shortcuts

The function enables the option of quick access for weighing functions, which are available when buttons F1, F2, F3 or F4 are pressed.

In the mode <PEAK HOLD> the following options are available, which a user can assign to each of the F buttons:

**NONE** – no function assigned to the button

**SELECT PRODUCT** – function initiates the option of selecting a product from product database

**LOG IN** – function initiates the option of selecting and logging-in of a balance's user

**ENTER TARE** – function initiates the option of inserting packaging mass

**SELECT TARE** – function initiates the option of selecting packaging mass from product database

**PRINT HEADER** – function initiates the print-out of a designed header

**PRINT FOOTER** – function initiates the print-out of a designed footer

**VARIABLE 1** – function initiates the selection and editing of variable 1

**VARIABLE 2** – function initiates the selection and editing of variable 2

*The way of declaring the function is described in the section relating to the weighing mode settings <F button shortcuts>.*

### 17.11.1. Means of operation

- Enter the mode <PEAK HOLD>



Once you select the mode, the function is activated and the information about the net mass appears in the bottom line (only if a different mass has not been selected by a user).

In order to operate properly, you should set the threshold in grams. It is the indicating point beyond which the function starts to register maximal force applied.

- From now on the balance registers and holds every single weightment which is above the threshold, and is higher than the result of the previous peak hold. If the software detects a mass above the threshold, the highest detected indication is held on the main display and the pictogram <Max> is shown at the top of the display.



A user can print the result out by pressing  button.

The start of the next process of peak hold measurement is possible only after



removing the load from the weighing pan and pressing button. This causes returning to the main mode <PEAK HOLD> and automatically deleting the pictogram <Max> on the top of display.



### Returning to the weighing mode



## 18. COMMUNICATION

The menu Communication enables the configuration of port settings, to which you

can get access by pressing  button.

The balance enables communicating with peripheral devices through the following ports:

- COM 1 (RS232),
- COM 2 (RS232),
- USB type A
- USB type B
- WIFI,

Parameters of the USB ports are not configurable. The port type B is designed to connect a printer or computer, and the port type A is designed to connect a computer keyboard, bar code reader or USB flash drive.

### 18.1. RS 232 ports settings

Procedure:

- Select a communication port <COM 1> or <COM 2>,
- Set relevant values

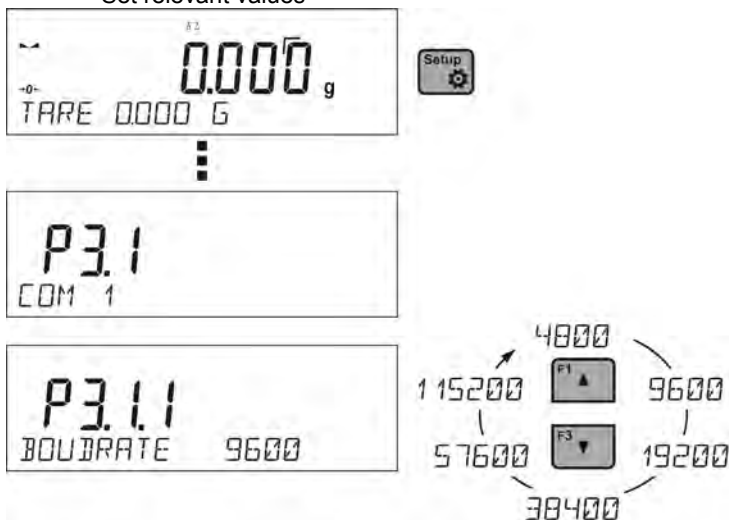

The RS 232 ports enable the following setting of transmission parameters:

- Baud rate - 4800, 9600, 19200, 38400, 57600, 115200 bit/s
- Parity - NONE, ODD, EVEN

## 18.2.WIFI port settings

### ATTENTION:

1. *The transmission parameters must be matched to the client's local network.*
2. *Most Wi-Fi modules work on one channel, which is defined in the configuration of the Wi-Fi network.*
3. *To ensure proper operation of the Wi-Fi router, automatically changing channels when configuring the connection set <AUTOCHANNEL> to <YES>.*

The parameters available for the Wi-Fi connection settings:

P3.3.1 – STATUS

P3.3.2 – CHOOSE NETWORK

P3.3.3 – NETWORK SETTING

P3.3.3.1 – NAME (the name of the network that has been selected)

P3.3.3.2 – PASSWORD (password – 'stars' are displayed)

P3.3.3.3 – CHANNEL NO (default <AUTO>)

P3.3.3.4 – IP (balance ID number, make sure that the number is not engaged by a different device operating in this network)

P3.3.3.5 – MASK (default 255.255.000.000)

P3.3.3.6 – GATE (default 10.10.8.244)

P3.3.3.7 – PORT (default 4000)







P3.3.3.8 – MAC ADRES (0008DC...)

P3.3.4 – WIFI STARTUP

After entering the parameter, the message <STATUS> and the value describing the state of the network Wi-Fi appear in the bottom line.

- **CONNECT** – it means that the balance is connected to one of the available Wi-Fi networks, additionally, at the top of the display the pictogram  appears. It is visible when the balance has an active network connection.
- **CONNECTIVITY** – it means that the balance is trying to connect to the network, to which it was previously connected, for previously entered settings (network, IP, etc.)
- **NONE** – the module Wi-Fi is not installed in the balance.

Procedure:

- Select the communication port <WIFI> and then set the appropriate values for the parameter <P3.3.3 – NETWORK PARAMETERS: IP; MASK; GATEWAY; PORT>
- Next, enter the parameter <P3.3.2 – SELECT NETWORK> and start the procedure of searching for available networks by pressing  button. Search procedure starts and after its completion the first network detected by the balance appears on the bottom line.
- Use the  or  buttons to select the network and press 
- The message <PASSWORD\*\*\*\*\*> appears on the bottom line. It is best to use a computer keyboard connected to the USB port, so you can easily enter the case-sensitive password. Enter the network password and confirm it by pressing 
- The balance software automatically guides you through the basic network parameters such as: CHANNEL AUTO (YES/NO), IP, MASK, GATE. The parameter values have default settings stored in the program. They can be changed by the user according to their needs. Note: the parameter <CHANNEL AUTO> if selected <YES> the Wi-Fi module in the balance will automatically connect to the network the next time it is used. It checks whether the channel that the router is working on has not been changed. If there has been a change the module automatically adjusts to the new router channel. This option eliminates the need to change the settings in the balance's Wi-Fi module when the router automatically changes channels.
- The balance returns to the parameter display <P3.3.2 – SELECT NETWORK>
- When you select a network and enter the password the balance automatically connects to the network.
- Go to the parameter <P3.3.1 – STATUS>, and in the description of this parameter the message <CONNECTIVITY> is displayed which means that the balance is trying to connect to the network using the settings entered.
- When the balance connects with Wi-Fi, the word on the status changes to <CONNECT> and also at the top of the balance the pictogram  will show.
- If the balance cannot connect to the network for a long time (as described in <CONNECTIVITY>, it is likely that network parameters have been incorrectly entered.
- Ensure that the settings are correctly entered, and repeat the process of joining the network.
- If this fails, contact your RADWAG service representative.

## 19. PERIPHERALS

The menu PERIPHERALS is to be found in the menu Parameters to which you can get access by pressing  button.

In the menu there is a list of devices which can cooperate with the balance.

### 19.1.Computer

In the submenu < COMPUTER> you should select a port, to which the computer with software that enables communication with the balance is connected.

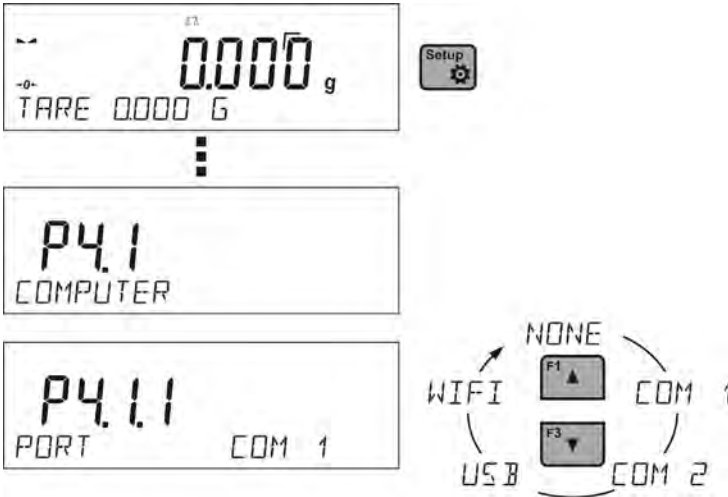

Procedure:

- press  button
- enter the menu <P4 DEVICES>
- and then enter in menu group <P4.1 COMPUTER>
- set the balance parameters related to the cooperation with the computer  
<P4.1.1 PORT> to which the computer is to be connected

Accessible options:

**COM 1** or **COM 2** – RS 232 port, to which the computer is connected

**USB** type B – USB port, to which the computer is connected

**WIFI** – WIFI port



## 19.2.Printer

In the submenu <PRINTER> the balance's user has a possibility of choosing a port



and device, to which the data is sent by pressing button on balance. The content of the data being transferred is set in parameter <PRINTOUTS/PRINTOUT GLP>.

Procedure:



- press button
- enter the menu <P4 DEVICES>
- and then enter in menu group<P4.2 PRINTER>
- set the balance parameters related to the cooperation with the printer  
<P4.2.1 PORT> to which the printer is to be connected

Accessible options:

**COM 1** or **COM 2** – RS 232 port, to which the printer is connected

**USB** type A – USB port, to which PCL printer is connected

**WIFI** –WIFI port, which can send data to special software manufactured by RADWAG e.g. WIN measurement, opened on the computer connected to the balance via WIFI.

**USB flash drive** –USB port type A, to which external memory flash drive is connected

**USB PC** –USB port type B, to which the computer with the special software by RADWAG is connected e.g. WIN measurement

*Example of the measurement printout is described in the PRINT-OUTS section.*

## 19.3.Bar code reader

The submenu <BAR CODE READER> includes the balance settings for cooperation with the bar code reader.

Procedure:



- press button
- enter the menu <P4 DEVICES>
- and then enter in menu group <P4.3 BAR CODE READER>
- set the balance parameters related to the cooperation with the bar code reader

<P4.3.1 PORT> - choice of the port, to which the bar code reader is to be connected

- o accessible options: NONE, COM 1, COM 2

## 19.4. Additional display

The submenu <ADDITIONAL DISP.> includes the balance settings for cooperation with the external additional display.

Procedure:

- press  button
- enter menu <P4 DEVICES>
- and then enter in menu group <P4.4 ADDITIONAL DISP.>
- set the balance parameters related to the cooperation with the additional display

<P4.4.1 PORT> - choice of the port, to which the additional display is to be connected

- o accessible options: none, COM 1, COM 2

### **ATTENTION:**

*The balance cooperates with an additional display manufactured by RADWAG.*

*Ensuring correct cooperation between the balance and the additional display requires that the parameter of the baud rate value set to 115200 bit/s for the port to which the additional display is plugged.*

## 20. WORKING WITH EXTERNAL DEVICES SUCH AS PRINTER OR COMPUTER

### CAUTION



A peripheral devices that is connected to RS 232 or USB port of a balance, has to be powered from the common low voltage power network equipped with common anti-shock protection in a way to preclude possible occurrence of different potentials in zero cables of the peripheral device and the balance.



**Transmission parameters in the balance must correspond to the parameters of the device that is connected to the balance.**

- Bound rate - 4800 ÷ 115200 bit / s
- Parity control - NONE, ODD, EVEN

The value indicated on balance's display can be sent through RS232 or USB port to a peripheral device in one of four accessible ways:

- manually - on pressing  button
- automatically - on stabilisation of weighing result
- continuously - on activation of a function or sending a command
- on command sent from a peripheral device (see additional functions).

The value indicated on balance's display can be sent through COM port or USB port in the following form:

- stable - data is sent immediately on stabilisation of weighing result  
(button )
- unstable - on pressing  button causes immediate sending of display status to a peripheral device (on a printout such status is marked with <?> symbol preceding the weighing result). This option is only available for non-verified balances.

## 20.1. Cable pinout diagram

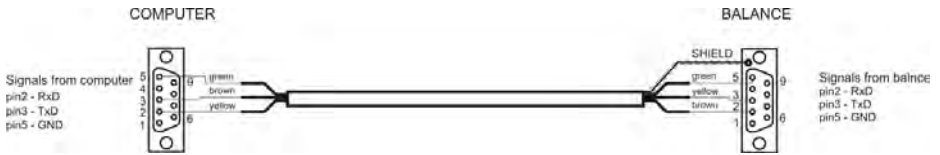

*Cable: balance – computer (RS232)*



*Cable: balance – printer KAFKA*

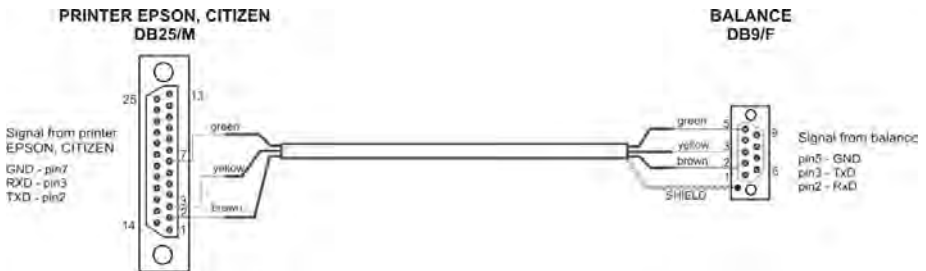

*Cable: balance – printer (CITIZEN, EPSON)*

## 20.2.Format of data setting

The measurement result can be sent from the balance to an external device by pressing  button on the balance or through sending a command from the computer.

## 20.3.Format of data sent on pressing of PRINT button



### ATTENTION

Unstable measurement print-out is not available for a verified balance.

Printout format

| 1                | 2     | 3         | 4 - 12 | 13    | 14 - 16 | 17 | 18 |
|------------------|-------|-----------|--------|-------|---------|----|----|
| stability marker | space | character | Mass   | space | unit    | CR | LF |

- stability marker - [space] – when stable  
 - [?] – when unstable  
 - [^] - if there is an error exceeding the maximal range +  
 - [v] - if there is an error exceeding the maximal range -
- character - [space] – for positive or [-] negative values
- mass - 9 characters – aligned to the right
- unit - 3 characters – aligned to the left.

### Format of data sent as response for commands generated from a computer

After entering a command balance responds to the following first:

- XX\_A CR LF - command understood and in progress
- XX\_I CR LF - command understood but not accessible at this moment
- XX\_^ CR LF - command understood but maximum range is exceeded
- XX\_v CR LF - command understood but minimum range is exceeded
- XX\_E CR LF - an error occurred on command carrying out (time limit exceeded while waiting for stable measurement result), time limit is balance's characteristic parameter
- XX - name of the command

and then:

| 1 - 3   | 4     | 5                   | 6     | 7         | 8 - 16 | 17    | 18 - 20 | 21 | 22 |
|---------|-------|---------------------|-------|-----------|--------|-------|---------|----|----|
| Command | space | stability<br>marker | space | character | Mass   | space | unit    | CR | LF |

- command - 1 ÷ 3 - characters
- stability marker - [space] – when stable
- [?] – when unstable
- [^] – if there is an error exceeding the maximal range +
- [v] – if there is an error exceeding the maximal range -
- characters - [space] – for positive or [-] values
- mass - 9 characters – aligned to the right
- unit - 3 characters – aligned to the left.

## 21. COMMUNICATION PROTOCOL

### General information

- A. A character based communication protocol balance-terminal is designed for establishing communication between a RADWAG balance and peripheral devices via RS 232 interface.
- B. It consists of commands sent from a peripheral device to the balance and responses from the balance.
- C. Responses are sent from the balance on each receipt of a command as a reaction to a specific command.
- D. Commands forming the communication protocol enable obtaining data on balance's status and influencing its operation, e.g.: request measurement results from the balance, zero indication, etc.

### 21.1. List of commands

| Command | Command description   |
|---------|---|
| Z       | Zero balance  |
| T       | Tare balance  |
| OT      | Give tare value   |
| UT      | Set tare  |
| S       | Send stable measurement result in basic measuring unit        |
| SI      | Immediately send measurement result in basic measuring unit   |
| SU      | Send stable measuring result in current measuring unit        |
| SUI     | Immediately send measurement result in current measuring unit |
| C1      | Switch on continuous transmission in basic measuring unit     |
| C0      | Switch off continuous transmission in basic measuring unit    |
| CU1     | Switch on continuous transmission in current measuring unit   |
| CU0     | Switch off continuous transmission in current measuring unit  |
| PC      | Send all implemented commands                                 |

#### Attention:

1. *Each command must end with CR LF characters; the spaces provided in the formats should be omitted, they are included only to improve readability.*

## 21.2. Responses format for commands sent from computer level

On receipt of a command, the terminal sends a response in one of the following formats:

|             |   |
|-------------|---|
| XX_A CR LF  | command understood and in progress  |
| XX_D CR LF  | command carried out (appears only after the command XX_A)   |
| XX_I CR LF  | Command understood but not accessible at this moment  |
| XX_^ CR LF  | Command understood but max range is exceeded  |
| XX_v CR LF  | Command understood but min range is exceeded  |
| XX_OK CR LF | Command carried out   |
| ES_CR LF    | Command not recognised  |
| XX_E CR LF  | An error occurred on command carrying out (time limit exceeded while waiting for stable measurement result), time limit is balance's characteristic parameter |

**XX** - stands for a name of sent command  
\_ - stands for spaces

## 21.3. Commands description

### Zero the balance

Format: **Z CR LF**

Accessible responses:

Z\_A CR LF - command understood and in progress  
Z\_D CR LF - command carried out  
Z\_A CR LF - command understood and in progress  
Z\_^ CR LF - command understood but zeroing range exceeded  
  
Z\_A CR LF - command understood and in progress  
Z\_E CR LF - time limit exceeded while waiting for stable measurement result  
  
Z\_I CR LF - command understood but not accessible at this moment



### Tare the balance

Format: **T CR LF**

Accessible responses:

- T\_A CR LF - command understood and in progress
- T\_D CR LF - command carried out
- T\_A CR LF - command understood and in progress
- T\_v CR LF - command understood but taring range exceeded
- T\_A CR LF - command understood and in progress
- T\_E CR LF - time limit exceeded while waiting for stable measurement result
- T\_I CR LF - command understood but not accessible at this moment

### Give tare value

Format: **OT CR LF**

Accessible response: **OT\_TARA CR LF** – command carried out

Response format:

|   |   |       |      |       |      |    |    |       |    |    |
|---|---|-------|------|-------|------|----|----|-------|----|----|
| 1 | 2 | 3     | 4-12 | 13    | 14   | 15 | 16 | 17    | 18 | 19 |
| O | T | space | tare | space | unit |    |    | space | CR | LF |

- Tare** - 9 characters with right justification
- Unit** - 3 characters with left justification

*Attention:*

*Tare value is always given in adjustment unit.*

### Set tare

Format: **UT\_TARA CR LF**, where **TARE** – tare value

Accessible responses:

- UT\_OK CR LF - command carried out
- UT\_I CR LF - command understood but not accessible at this moment
- ES CR LF - command not recognised (tare format incorrect)

*Attention:*

*Use dot in tare format as decimal point.*

**Send stable measurement result in basic measuring unit**

Format: **S CR LF**

Accessible responses:

- S\_A CR LF - command understood and in progress
- S\_E CR LF - time limit exceeded while waiting for stable measurement result
- S\_I CR LF - command understood but not accessible at this moment
- S\_A CR LF - command understood and in progress
- MASS FRAME - response is mass value in basic measuring unit

Frame format:

|   |       |                  |       |           |      |       |      |    |    |    |    |
|---|-------|------------------|-------|-----------|------|-------|------|----|----|----|----|
| 1 | 2-3   | 4                | 5     | 6         | 7-15 | 16    | 17   | 18 | 19 | 20 | 21 |
| S | space | stability marker | space | character | mass | space | unit |    |    | CR | LF |

**Example:**

**S CR LF** – command sent from a computer

**S\_A CR LF** – command understood and in progress

**S \_\_\_\_\_ - \_\_\_\_\_ 8 . 5 \_ g \_ \_ CR LF** – command carried out, response in mass value in basic measuring unit.

**Immediately send measurement result in basic measuring unit**

Format: **SI CR LF**

Accessible responses:

- SI\_I CR LF - command understood but not accessible at this moment
- MASS FRAME - response is immediate with mass value in basic weighing unit

Frame format:

|   |   |       |                  |       |           |      |       |      |    |    |    |    |
|---|---|-------|------------------|-------|-----------|------|-------|------|----|----|----|----|
| 1 | 2 | 3     | 4                | 5     | 6         | 7-15 | 16    | 17   | 18 | 19 | 20 | 21 |
| S | I | space | stability marker | space | character | mass | space | unit |    |    | CR | LF |

**Example:**

**S I CR LF** – command sent from a computer

**S I \_ ? \_ \_ \_ \_ \_ \_ 1 8 . 5 \_ k g \_ \_ CR LF** – command carried out, immediate response of mass value in basic weighing unit.

**Send stable measurement result in current weighing unit**

Format: **SU CR LF**

Accessible responses:

- SU\_A CR LF - command understood and in progress
- SU\_E CR LF - time limit exceeded while waiting for stable measurement result
- SU\_I CR LF - command understood but not accessible at this moment

- SU\_A CR LF - command understood and in progress
- MASS FRAME - response is mass value in current measuring unit

Frame format:

| 1 | 2 | 3     | 4                   | 5     | 6         | 7-15 | 16    | 17   | 18 | 19 | 20 | 21 |
|---|---|-------|---------------------|-------|-----------|------|-------|------|----|----|----|----|
| S | U | space | stability<br>marker | space | character | mass | space | unit |    |    | CR | LF |

**Example:**

**S U CR LF** – command sent from a computer

**S U \_ A CR LF** – command understood and in progress

**S U \_ \_ \_ - \_ \_ 1 7 2 . 1 3 5 \_ N \_ \_ CR LF** – command carried out  
response in mass value in current measuring unit.

**Immediately send measurement result in current measuring unit**

Format: **SUI CR LF**

Accessible answers:

SUI CR LF - command understood but not accessible at this moment

MASS FRAME - mass value in current measuring unit is returned immediately

Frame format

|   |   |   |                  |       |           |      |       |      |    |    |    |    |
|---|---|---|------------------|-------|-----------|------|-------|------|----|----|----|----|
| 1 | 2 | 3 | 4                | 5     | 6         | 7-15 | 16    | 17   | 18 | 19 | 20 | 21 |
| S | U | I | stability marker | space | character | mass | space | unit |    |    | CR | LF |

**Example:**

**S U I CR LF** – command from a computer

**S U I ? \_ - \_ \_ \_ 5 8 . 2 3 7 \_ k g \_ CR LF** – command carried out,  
immediate response of mass value in current measuring unit

where: \_ - space

**Switch on continuous transmission in basic measuring unit**

Format: **C1 CR LF**

Accessible answers:

C1\_I CR LF - command understood but not accessible at this moment

C1\_A CR LF - command understood and in progress

MASS FRAME - response is mass value in basic measuring unit

Frame format

|   |   |       |                  |       |           |      |       |      |    |    |    |    |
|---|---|-------|------------------|-------|-----------|------|-------|------|----|----|----|----|
| 1 | 2 | 3     | 4                | 5     | 6         | 7-15 | 16    | 17   | 18 | 19 | 20 | 21 |
| S | I | space | stability marker | space | character | mass | space | unit |    |    | CR | LF |

**Switch off continuous transmission in basic measuring unit**

Format: **C0 CR LF**

Accessible responses:

- C0\_I CR LF - command understood but not accessible at this moment  
 C0\_A CR LF - command understood and carried out

**Switch on continuous transmission in current measuring unit**

Format: **CU1 CR LF**

Accessible responses:

- CU1\_I CR LF - command understood but not accessible at this moment  
 CU1\_A CR LF - command understood and in progress  
 MASS FRAME - response is mass value in current measuring unit

Frame format

|   |   |   |                     |       |           |      |       |      |    |    |    |    |
|---|---|---|---------------------|-------|-----------|------|-------|------|----|----|----|----|
| 1 | 2 | 3 | 4                   | 5     | 6         | 7-15 | 16    | 17   | 18 | 19 | 20 | 21 |
| S | U | I | stability<br>marker | space | character | mass | space | unit |    |    | CR | LF |

**Switch off continuous transmission in current weighing unit**

Format: **CU0 CR LF**

Accessible responses:

- CU0\_I CR LF - command understood but not accessible at this moment  
 CU0\_A CR LF - command understood and carried out

**Send all the implemented commands**

Format: **PC CR LF**

- Response: **PC\_A"Z,T,S,SI, SU,SUI,C1,C0,CU1,CU0,PC"**  
 - command carried out, the indicator sent all the implemented commands

**22. ERROR MESSAGES**

- Err2-** Value beyond zero range,  
**-Err3-** Value beyond tare range,  
**-Err8-** Tarring / Zeroing operation time exceeded,  
**-NULL-** Zero value from converter,  
**-FULL-** Measurement range exceeded,  
**-LH-** Start mass error,



## 23. UNDER HOOK WEIGHING

In standard analytical and precision balances loads can be weighed under the weighing pan. Such means of operation requires placing a balance on an uplifted position. RADWAG offers a rack for under hook weighing. The rack is optional equipment offered for balances PS series.

For under hook weighing follow below procedure:

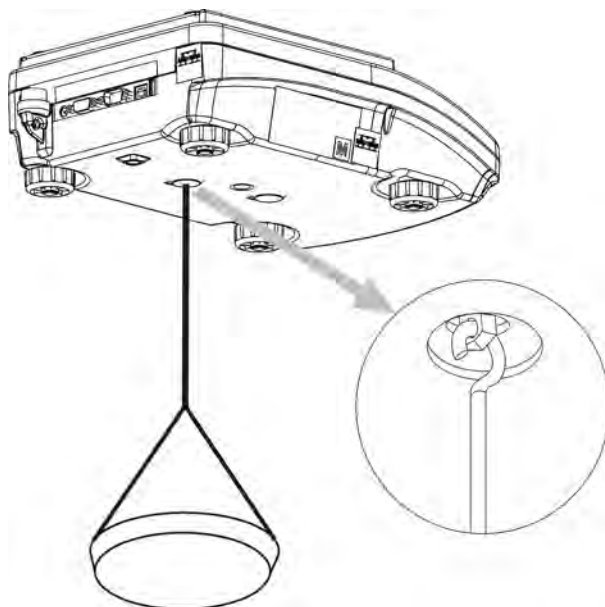

- Remove plastic hole plug in basis of a balance,
- There is suspension place for hook visible in the hole – the suspension installed permanently to balance mechanism,
- In the hole install the hook for under hook weighing – the hook is standard equipment of a balance. Weigh loads using under hook option;
- As under hook weighing is finished, close the hole in balance basis with plastic hole plug.



### CAUTION

***The suspension for hook must not be turned, twisted or manipulated in any direction. Such actions may cause damage to balance mechanism.***

*Mass of all additional elements of under hook weighing kit, like, the hook,*

*weighing pan, string, etc. should be zeroed by pressing  Delete or  Insert.*

## 24. ADDITIONAL EQUIPMENT

### 24.1. Anti-vibration table



It is a very stable basis which eliminates all kinds of vibrations and ground shakes. The inner part of the table holds a marble plate, which is a foundation for balance positioning.

### 24.2. Rack for under hook weighing

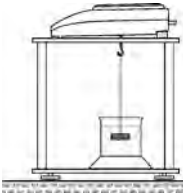

The rack is used if under hook weighing option has to be applied. Under hook weighing is necessary if magnetic loads are weighed or during density determination of substances. Racks are also used for measuring absorptiveness of substances e.g. foamed polystyrene. The rack is made of mild steel. Rack height is 330mm.

### 24.3. Density determination kit (for solids and liquids)



It is applicable with balance with resolution at least 1 mg. designed for density determination of solids and liquids. The procedure is fully automatic, i.e. the user only places samples on kit's weighing pans.

### 24.4. Additional display



Features: Length of cable between additional display and balance – 1,5m, plastic casing, with tilting option.

*Number of instruction:  
LMI-64-04/09/13/ENG*



**MANUFACTURER**  
OF ELECTRONIC WEIGHING  
INSTRUMENTS



RADWAG Balances & Scales  
26 – 600 Radom  
28 Bracka Street  
POLAND

phone. +48 48 38 48 800  
fax. + 48 48 385 00 10  
Sales Department + 48 48 366 80 06  
**[www.radwag.com](http://www.radwag.com)**

