

Video Door Phone

Operating Instruction



6320000033H



Hanmi Building 45, Pang-E Dong, Songpa-Ku
Seoul 138-724, Korea
Tel 82.2.2240.9234/9271/9273
Web site : www.hyundaitel.com



Hyundai Telecom Printed in Korea

For your protection, Please read these instructions completely and keep it for future reference



WARNING

To prevent injury, the following safety precautions should be observed in the installation, use and servicing of the set.

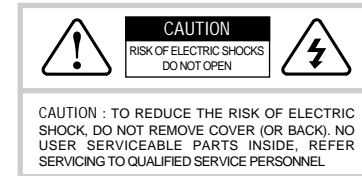

This symbol is intended to alert the user to the presence of uninsulated “dangerous voltages” within the product’s enclosure that may be of sufficient magnitude to constitute a risk of electric shock to the user.



This symbol is intended to alert the user to the presence of important operating and maintenance (servicing) instructions in the literature accompanying the appliance.

For the customers

This equipment has been tested and found to comply with the limits for a Class B digital device, pursuant to Part 15 of the FCC Rules.

These limits are designed to provide reasonable protection against harmful interference in a residential installation. This equipment generates, uses, and can radiate radio frequency energy and, if not installed and used in accordance with the instructions, may cause harmful interference to radio communication. There is no guarantee that interference will not occur in a particular installation. If this equipment does cause harmful interference to radio or television reception, which can be determined by turning equipment off and on. The user is encouraged to try to correct the interference by one or more of the following measures:

- Reorient or relocate the receiving antenna.
- Increase the separation between the equipment and receiver.
- Connect the equipment into an outlet on a circuit different from that to which the receiver is connected.
- Consult the dealer or an experienced radio/TV technician for help.

Note : Change or modification not expressly approved by the party responsible for compliance could void the user’s authority to operate the equipment.

SAFEGUARDS

1. Read Instructions

All the safety and operating instructions should be read before the unit is operated.

2. Retain Instructions

The safety and operating instructions should be retained for future reference.

3. Follow Instructions

All operating instructions, maintenance and all warnings should be followed.

4. Cleaning

Turn off the power to the unit before cleaning. Do not use liquid or aerosol cleaners. Use a dry cloth for the body of unit.

5. Attachments

Do not use attachments not recommended by the unit product manufacturer, as they may be hazardous or cause damage.

6. Heat and Moisture

Do not expose this unit to direct sunlight or rain for reliable operation.

7. Installation

Do not install this unit on an unstable place (hot, cold, humid or excessive dust). Use only with a mounting accessory recommended by the manufacturer or sold with the unit. Follow instructions of the manufacturer and qualified service personnel when installing this unit.

8. Ventilation

Slots and openings in the cabinet are provided for ventilation to ensure reliable operation of the unit and to protect it from overheating. These openings must not be blocked or covered. Never place your unit on a bed, sofa, rug, or similar surface or on or near a radiator or heat register. This unit should not be placed in a built-in installation such as a bookcase or rack unless proper ventilation is provided.

9. Power Sources

This unit should be operated only from the type of power source indicated on the label. If you are not sure of the type of power supplied to your home, consult your appliance dealer or local power company. To operate the unit by battery of another power source, consult the operating instructions.

10. Grounding and Polarization

This unit may be equipped with either a polarized 2-wire DC adaptor line plug

(a plug having one blade wider than the other) or a 3-wire grounding type plug, a plug having a third (grounding) pin. The 2-wire polarized plug will fit into the power outlet only one way. This is a safety feature. If you are unable to insert the plug fully into the outlet, try reversing the plug. If the plug still fails to fit, contact your electrician to replace your outlet. Do not defeat the safety purpose of the polarized plug.

11. Overloading

When using this product, do not overload the power outlets or extension cords as this could cause fire or electric shock.

12. Accessories

Do not place this unit on an unstable cart, stand, tripod, bracket, or table. If the unit falls, it could cause injury or damage to the system.

13. Object and Liquids

Never push objects of any kind into this unit through the openings. Never spill liquid of any kind on the unit.

14. Servicing

Do not attempt to service this unit yourself as opening or removing covers may expose you to dangerous voltages or other hazards. Refer all servicing to qualified service personnel.

15. Power Line

The system should not be located near power lines or electric lights or power circuits.

16. Damage Requiring Service

Unplug this unit from the wall outlet and refer servicing to a qualified service person if any of the following occur :

- a. If the power supply cord or plug is damaged.
- b. If any liquid has been spilled into or objects have fallen in the unit.
- c. If the unit has been exposed to rain or water.
- d. If the unit has been dropped or otherwise damaged.
- e. If the equipment exhibits a distinct change in performance.

17. Replacement Parts

When replacement parts are required, use replacement parts specified by the manufacturer.

Important Notice

Always use discretion when installing video and audio surveillance equipment especially when there is perceived privacy, or an expectation of privacy. Inquire regarding federal, state and/or local regulations applicable to the lawful installation of video and/or audio recording or surveillance equipment. Party consent may be required.

TABLE OF CONTENTS

UNIT & COMPONENTS	6
PARTS CHECK-LIST	8
INSTALLATION	10
WIRING DIAGRAM	12
OPERATION	14
TROUBLE SHOOTING	16
SPECIFICATIONS	17

UNIT & COMPONENTS

UNIT & COMPONENTS

Monitor

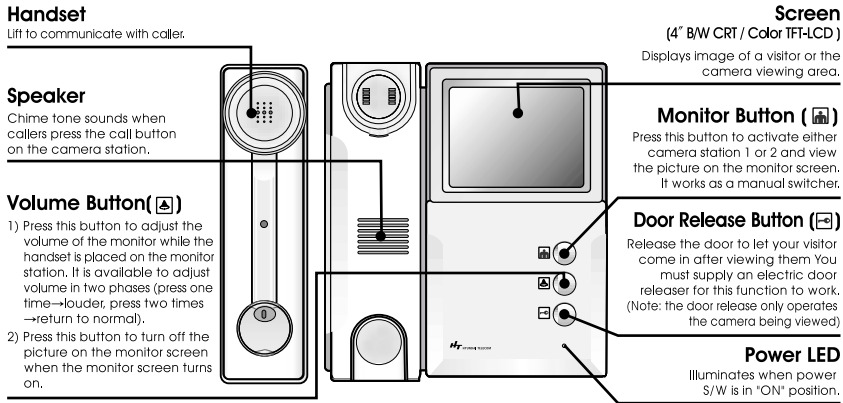

Side & Bottom panel

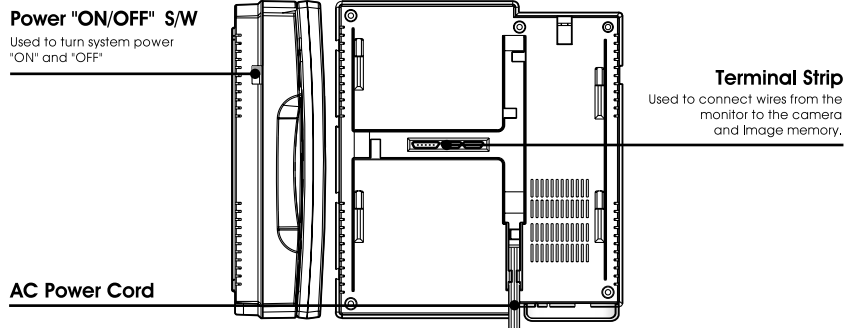

Camera (HCB-300/HCC-300)

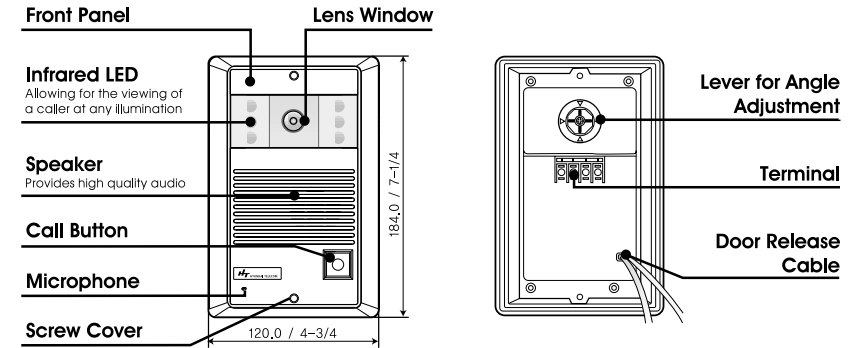

Side & Bottom panel

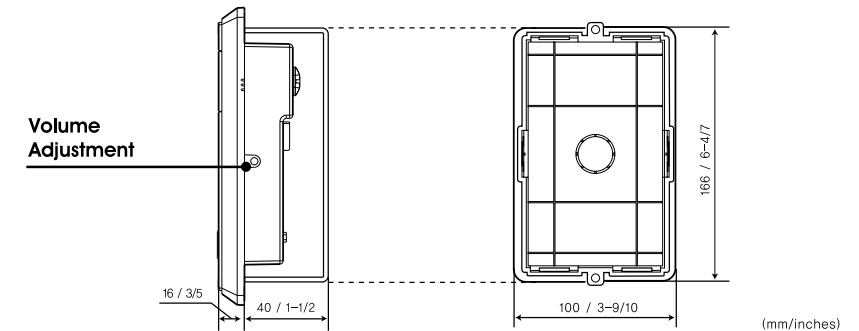

Note : If the camera lens angle requires adjustment, simply position the lever of angle adjustment and then tighten the screw on it with a philip screwdriver before installation.

PARTS CHECK-LIST

The parts shown below are provided by the manufacturer and are enclosed in the box.



Handset

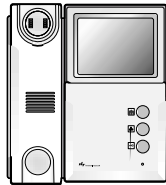

Main

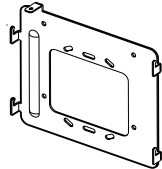

Mounting Bracket

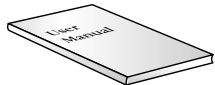

User Manual



Monitor Mounting Screws
(3 x 8 mm)



Mounting Screw
(4 x 20 mm)



Cable

Camera (HCB/HCC-500)

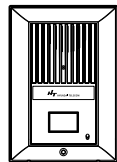

HCB/HCC-500

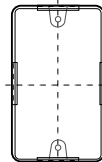

Wall Bracket
Screw(4 x 30mm)



Tamper Proof
Screws (3 x 8 mm)



Wrench



Rubber screw Cover

Camera (HCB/HCC-300)

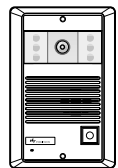

HCB-300/HCC-300

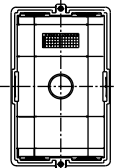

Flush Box



Wrench



Tamper Proof
Screws (3 x 30 mm)



Rubber screw
Covers

Camera (HCB/HCC-150E)



HCB-150/HCC-150

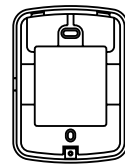

Bracket



Mounting Screws
(4 x 20 mm)



Camera Mounting
Screw (3 x 8 mm)

INSTALLATION

< Figure 1 >

INSTALLATION

Installation

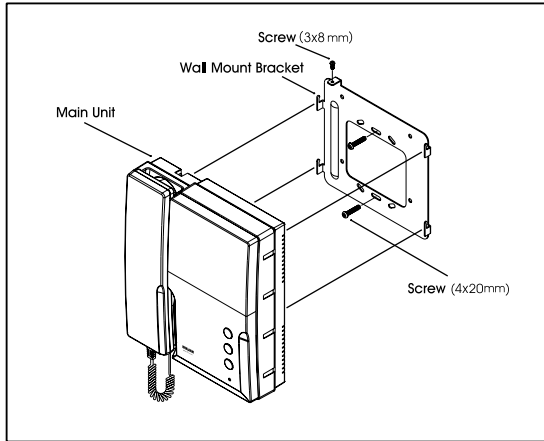

< Figure 2 >

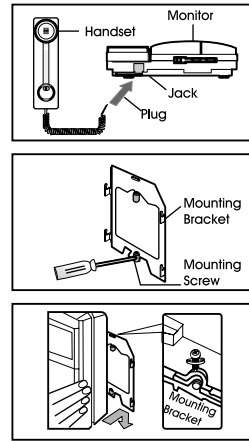

< Figure 3 >

1. After determining the mounting locations for both the outside camera and inside monitor, it is recommended to mount the camera and monitor to the height of an average adult's eye level from the ground (Approx. 1500mm / 59 inches).
2. At the selected monitors mounting location, attach the mounting bracket firmly to the wall.
Drill a hole in the center area of the bracket just large enough for the electrical wiring to pull through the hole. Connect the electrical wires from the camera unit to the monitor-wiring terminal strip.
3. Connect the handset cord to the monitor unit.
4. Attach the wired monitor unit to the wall mounting bracket by setting the monitor over the four bracket hook and slide it down, Insert the tiny machine screw into the hole in the tab at the top of the bracket to hold the monitor in place.
5. Plug the AC power cord into a standard household outlet.
6. Place the Power "On/Off" switch in the "On" position.

Camera (HCB/HCC-300)

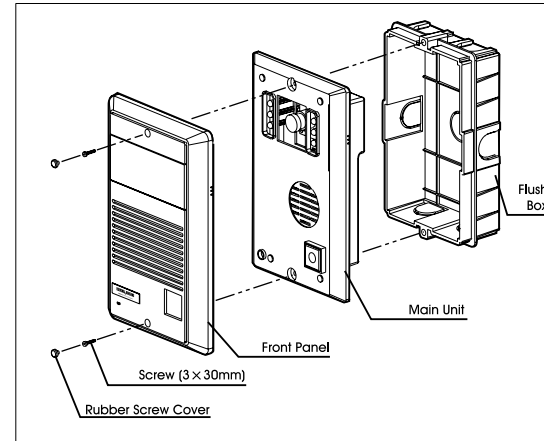

< Figure 4 >

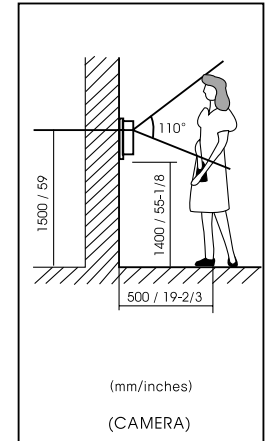

< Figure 5 >

1. It is recommended to mount the flush box of the camera into the wall.
2. Remove the front panel from the main unit
3. Place the front panel on the main unit and attach them to the flush box with two tamper proof screws provided.

Important Mounting Notes:

Do not install the monitor and camera units where they will be exposed to dirt, direct sunlight (or other strong light), direct moisture, high temperature (over 40°C) or high humidity conditions. Do not select an installation location subjected to vibration or pounding.

Select a mounting location close to an AC outlet where it is easy to view the CRT screen and operate the monitor.

WIRING DIAGRAM

■ 1 Monitor & 1 Camera & Image Memory

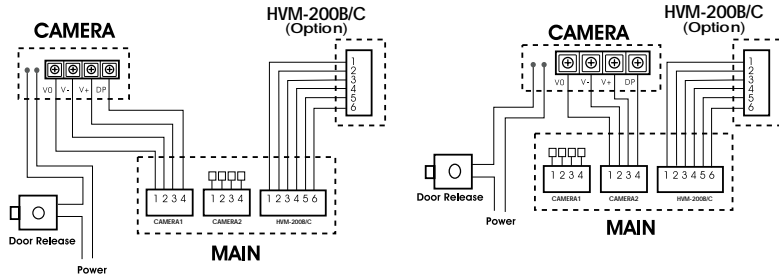

< Figure 6 >

■ 1 Monitor & 2 Cameras

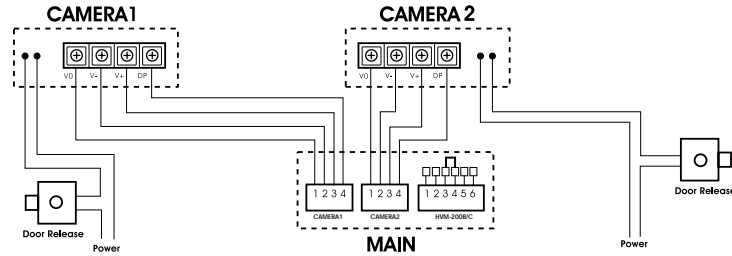

< Figure 7 >

■ 2 Monitors & 2 Cameras & Image Memory

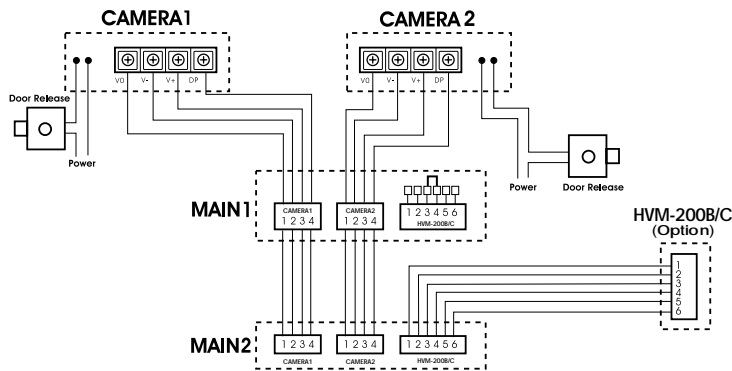

< Figure 8 >

Wiring is not supplied with your Video Doorphone System. Use only AWG #22 wire(0.65mm) / TIV wire(0.80mm) and follow the appropriate wiring diagrams exactly for optimum system performance and safety.

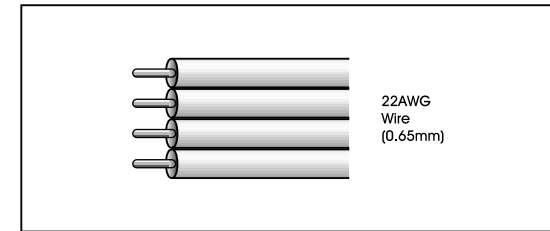





< Figure 9 >

When planning the initial HA-201/HAC-201 System wiring installation, consider future system expansion. The total wire length for a single camera and monitor system (or any combination of additional cameras or monitors) must not exceed 50m/165feet total wiring for optimum performance.

- Note :**
- 1) Connect 3,4 shut pin on the HVM-200B/C when you are not using image memory
 - 2) Use of color coded cable is recommended for proper wiring connection.

OPERATIONS



How to use buttons & adjustment on the unit

BUTTON		DESCRIPTION
Monitor		Turn on screen, switch cameras
Volume		Volume adjustment, Turn off screen
Door		Door release
HVM-200B/C	Time	Time Adjustment (Enter or Move: Use Time button,  :Use Record button,  :Use Review button)
	Rec	Record manually.
	Review	Review recorded pictures
	Away	Set or Reset "Absence" mode or quit the review

Communicating Function

- A visitor presses the "Call" button on the outside camera unit.
The monitor will sound a "chime" tone two times to announce that a visitor is at the door. (The picture on the monitor screen will appear)
- Lift the handset to speak to the visitor.
- Hang up the handset to terminate the conversation or if more than 30seconds elapses after you lift the handset, the image on the monitor screen will disappear.
- If you install more than one monitor, each monitor will sound a "chime" tone two times respectively after a visitor presses the "Call" button on the outside camera unit. (The same picture on each monitor screen will appear). If you lift the handset or master monitor for response, the image on the secondary monitor will turn off after 30 seconds automatically.
- The picture on the monitor screen will be replaced after another visitor presses the "Call" button of the secondary camera while you speak to previous caller at the master camera.
If you press "Monitor" button () again, your call returns to the previous caller at the master camera.

Monitoring Function

- Press "Monitor" button () to see the camera viewing area.
- If you install more than two cameras, it will function in the following way:
 - Press "Monitor" button to see the master camera viewing area and then press "Monitor" button again to see the secondary camera viewing area.
- To turn off the monitor screen, hang up the handset or press "Volume" button ()

Operating the Electric Door Release

- After speaking with the visitor (and if you have installed an electronic door locking system), you can press the "Door release" button () to electronically unlock the door.

TROUBLE SHOOTING

If a problem persists after trying the remedies suggested below, contact your local dealer or our technical support or sales department

Unit totally dead (Power Lamp OFF)

- The power cord is not properly inserted in the AC outlet, or the power is not supplied.
- Check that the power ON/OFF switch is in the ON position.

Cannot gain enough volume when talking to other units

- Adjust volume with the button on the monitor (See page 6.)

Poor picture appears on the screen

- Make sure that the lens of outdoor camera is clean (Remove the transparent tape attached on the outdoor camera after installation)
- After rain or when outside temperatures are very low, the camera lens may temporarily fog over and cause a blurry image, but this is not malfunction and normal operation will be restored when the moisture evaporates.
- The camera lens may be affected if it is in very bright direct sunlight from the sun or artificial street or house light. When installing, if possible, choose a site that is partially sheltered from direct light.

Can call and communicate, however, there is no audio signal

- Make sure the wiring between the monitor station and the camera station is connected properly.

SPECIFICATIONS

Main unit Monitor

Remark		Specifications
Voltage Requirements		DC 12V, 1.5A or 90-250V AC 50/60Hz(Smps)
Power Consumption		Maximum 8.5W, Stand by 1.0W
Monitor Screen		B&W Flat 4" Flat type C.R.T/4" TFT-LCD
Maximum Wiring Distance		50m/165 feet (22 AWG, 0.65mm 4wire)
Audio Communication		Duplex handset
Extensions		Monitor
Environment	Temperature	-10° C to +40° C
	Humidity	Below 90% (relative)
Size	Dimension	188W x 208H x 60D(mm) / 7-2/5W x 8-1/5H x 2-1/3D(Inches)
	Weight	1.3 kg / 2.86 lbs
Installation		Surface Mount Type

Flush Mount Camera (HCB-300/HCC-300)

Remark		Specifications
Power Source		DC 12V (Supplied from Monitor)
Power Consumption		DC 12V, 0.25A
Display Output		1Vp-p/75, Composite EIA / CCIR, PAL/NTSC
Illuminance		0.1 Lux(B/W)/3Lux(Color)
Environment	Temperature	-10° C ~ 40° C
	Humidity	Below 90% (relative)
Size	Dimension	120W x 184H x 16D(mm) / 4-3/4W x 7-1/4H x 3/5D(Inches)
	Weight	0.5kg / 1.10 lbs
Installation		Flush Mount Type

Flush Mount Camera (HCB-500/HCC-500)

Remark		Specification
Power Source		DC 12V (supplied from Monitor)
Power Consumption		DC 12V, 0.17A
Display Input		1Vp-p/75, Composite CCIR/EIA, PAL/NTSC
Minimum Illuminance		0.1 Lux (B/W) / 3 Lux(Color)
Environment	Temperature	-10° C ~ 40° C
	Humidity	Below 90% (relative)
Size	Dimension	91.5W×132.5H×18D(mm) / 3-3/5W×5-1/5H×5/7D(Inches)
	Weight	0.2kg / 0.44 lbs
Installation		Flush Mount Type

Surface Mount Camera (HCB-150E/HCC-150E)

Remark		Specifications
Power Source		DC 12V (Supplied from Monitor)
Power Consumption		DC 12V, 0.15A
Display Output		1Vp-p/75, Composite EIA / CCIR
Illuminance		0.1 Lux (B/W)
Environment	Temperature	-10° C ~ 40° C
	Humidity	Below 90% (relative)
Size	Dimension	86W×117H×39D(mm) / 3.39W×4.61H×1.54D(Inches)
	Weight	0.2kg / 0.44 lbs
Installation		Surface Mount Type

Warranty Conditions

HYUNDAI TELECOM Products are supplied with one(1) year return to base warranty from the date of purchase. We will repair or replace the defective item with a new or factory rebuilt replacement.

Condition

1. This warranty applies to the original purchaser only.
2. All warranty will be invalid if unauthorized repair or modification are made to the unit or in any case of accident, misuse, damage caused by improper installation and altered serial numbers.
3. The liability of **HYUNDAI TELECOM** is limited to the cost of repair/replacement of the unit under warranty.
4. If you need a warranty service, you should send the product to our customer service Dep't or dealer office. The product in all cases must be accompanied by the following items:
Your name, address, telephone number, the serial number, copy of your sales receipt showing the purchase date.

The Model Number is on the box and front of the manual. The Serial Number is on the bottom of the unit. Record the Model and Serial Numbers in the spaces provided below. Refer to these numbers for warranty service.

Model No. _____

Serial No. _____

Memo
