

User Manual

ELISYS 2

REVISION LIST OF THE MANUAL

No.	DATE / Rev.	REVISION DESCRIPTION
0	990614	Preliminary issue
1	000727	NEW: Block- and Group-Definitions
2	000915	NEW: Spare Parts, Page 55 NEW: Rack definition, Page 56
3	000921	NEW: External Incubation, Page 45; NEW: Single step operations, Page 30
4	000925	CHANGE: Maintenance, Page 46 NEW: Change syringe tip, Page 48 CHANGE: Decontamination procedure, Page 47
5	020423	NEW: Software Version 3.28 CHANGE : Spare Parts- Consumables, Page 68
6	030217	NEW: Integration of new ELISA Tests CHANGE: Updated rack description

This side left blank

CONTENTS

INTRODUCTION	5
0.1. Description	5
0.2. User Warranty	5
SECTION 1	7
GENERAL SAFETY WARNINGS	7
1.1. Danger-Warning Symbols	7
1.2. Intended Use of the Instrument	7
1.3. Use of the Instrument	8
SECTION 2	9
GENERAL INFORMATION	9
2.1. Instrument Description: Purpose and Features	9
2.2. Manufacturer's Identification Label	9
2.3. Instrument Description	10
2.4. Instrument Measuring Principle	11
SECTION 3	12
INSTRUMENT TECHNICAL DATA	12
3.1. Main Features	12
3.2. Instrument Technical Specifications (*)	13
SECTION 4	15
INSTALLATION AND START-UP INSTRUCTIONS	15
4.1. Unpacking	15
4.2. Placing the Instrument	16
4.3. Power Supply	16
4.4. Wash And Waste Container Installation	17
4.5. Work Area	18
4.5.1 Samples Tray	19
4.5.2 Trays for Reagents and Controls	19
4.5.3 Pre-dilution Plate	19
4.5.4 Microplate	19
4.5.5 Wash Basin for the Needle	19
4.5.6 Reader – Washer Group	19
4.6. Elisys 2 - PC Connection	20
4.7. Software Installation on PC	20
4.7.1. PC Minimum Requirements	20
4.7.2. Software Installation	20
SECTION 5	21
OPERATING INSTRUCTIONS	21
5.1. Introduction	21
5.1.1. Operating Overview	21
5.1.2. Powering the Instrument	22
5.1.3. PC program starting	22
5.1.4. Operating Menu	22
5.2. Work Session Setup	24
5.2.1. Select Profile	25
5.2.2. Set Parameters	26
5.2.3. Sample Setting	27
5.2.4. Single Step Operation	28
5.2.5. Entering the Patient Card	31
5.3. Run Analysis	32
5.3.1. Run the Process	33
5.3.2. Work Area Preparation	33
5.3.3. Analysis Execution (Running Phase)	34
5.3.4. Displaying the Results and their Acceptance Evaluation	35
5.3.5. Patient Reports	36
5.4. Databases	37
5.4.1. Medical reports	37
5.4.2. Patient Cards	38
5.4.3. Notes	39
5.4.4. Assays	39

5.5	Assay Parameter Setup	40
5.5.1	Working Parameters	47
5.6	Rack Arrangements	53
5.6.1	Disposition on the Working Area- Standard Racks	53
5.6.2	Disposition on the Working Area -Universal Racks	54
5.6.3	Disposition on the Working Area - Mixed Arrangement	54
5.6.4	Working with two Substrates	55
5.6.5.	Definitions for BLOCK-, RACK TYPE- AND GROUP PARAMETER	55
5.7.	Settings	56
5.7.1	Break on error	56
5.7.2	External Incubation	56
5.7.3	Simulation mode	57
5.7.4	92 Positions for predilution	58
5.7.5	Substrate incubation at 37°	58
5.7.6	Dilution and wash buffer names	58
5.8	Commands	59
	SECTION 6	60
	MAINTENANCE	60
6.1.	Checks and Preventive Maintenance	60
6.2	Cleaning the Instrument's Parts	61
6.3	Tubing, Diluter and Manifold Decontamination	61
6.4	General Inspections and Checks	61
6.5	Replace the Syringe Tip	62
	SECTION 7	63
	PUTTING THE INSTRUMENT OUT OF SERVICE	63
7.1.	General Warnings	63
7.2.	Put the Instrument out of Service	63
7.2.1.	Momentary Stocking	63
7.3.	Instrument Transport and Handling	64
7.4.	Instrument Storage	64
	APPENDIX A	65
	INSTRUMENT DECONTAMINATION	65
	Decontamination Procedure	65
	Decontamination Declaration	66
	APPENDIX B	67
	Spare Parts – Consumables – Accessory Parts	67
	APPENDIX C	68
	ELISYS 2 Rack Description	68
	APPENDIX D	69
	Group – Rack-Block -Division	69
	APPENDIX E	70
	Definitions for Groups	70
	Group No.1	70
	Group No.2	70
	Group No.3	71
	Group No.5	71
	Group No.20	72
	Group No.131	72
	APPENDIX F	73
	On Line Module	73
	APPENDIX G	75
	Operating Flow Diagramm	75

INTRODUCTION

0.1. Description

The purpose of the automated microplates analyzer ELISYS 2 is to analyse samples on microplates; it has been specifically conceived to automatically process up to 2 plates on line.

This manual provides the operator with all the necessary instructions for a safety, suitable use as well as the instrument maintenance recommendations.

Manual content:

- **introduction** - warranty information and the CE conformity declaration
- **section 1** - general safety-warnings;
- **section 2** - general information such as the producer data, instrument description;
- **section 3** - instrument performances, technical data;
- **section 4** - installation and start up;
- **section 5** - operating instructions;
- **section 6** - the user's periodic maintenance and checking and the repair policy;
- **section 7** - how to put the instrument out of service, packaging, transport instructions;
- **section 8** – Appendices including instrument decontamination and spare parts list .

This manual is considered as a part of the instrument; it has to be at the operator's hand as well as at the maintenance operator's availability.

For accurate installation, use and maintenance, please read the following instructions carefully. In order to avoid instrument or personal damages, carefully read the "GENERAL SAFETY WARNINGS" Section 1, describing the suitable operating procedures.

In case of breakdowns or any troubles with the instrument, apply to the local Technical Service.

0.2. User Warranty

HUMAN warrants that instruments sold by one of its authorised representatives shall be free of any defect in material or workmanship, provided that this warranty shall apply only to defects which become apparent within one year from the date of delivery of the new instrument to the purchaser.

The HUMAN representative shall replace or repair any defective item at no charge, except for transportation expenses to the point of repair.

This warranty excludes the HUMAN representative from liability to replace any item considered as expendable in the course of normal usage, e.g.: lamps, valves, syringes, glassware, fuses, diskettes, tubing etc.

The HUMAN representative shall be relieved of any liability under this warranty if the product is not used in accordance with the manufacturer's instructions, not regularly maintained, used with equipment not approved by HUMAN or used for purposes for which it was not designed.

HUMAN shall be relieved of any obligation under this warranty, unless a completed installation / warranty registration form is received by HUMAN within 15 days of installation of this product.

This warranty does not apply to damages incurred in shipment of goods. Any damage so incurred shall be reported to the freight carrier for settlement or claim.

0.3. CE CONFORMITY



DECLARATION OF CONFORMITY

The producer declares that the instrument:

AUTOMATED MICROPLATE ANALYZER

model: ELISYS 2

Manufactured for HUMAN GmbH Germany

Cat. No 17300

conforms to the following EEC Directives, included the last modifications:

73/23/EEC regarding low voltage

89/336/EEC regarding Electromagnetic Compatibility

93/68/EEC regarding the CE marking

and that the below harmonized standard specifications have been applied:

Safety:

CEI EN 61010-1 (1994) / CEI 66-5 " Safety requirement regarding electrical equipment for measurement, control and laboratory use "

Electromagnetic Compatibility:

Emission: EN 55011 (1989) (CEI 110-6)

Immunity: EN 50082-1 (1992) (CEI 110-8)

The General Manager

SECTION 1

GENERAL SAFETY WARNINGS

1.1. Danger-Warning Symbols

In this manual the following symbols are to remind the user of the safety rules:



This is a symbol of generic DANGER. It means that serious dangers might occur to the operator if the described precautions are not fulfilled.



This is a symbol of high electrical voltage; by touching parts reporting this label, life endanger might occur. Parts reporting this label can be handled only by qualified operators after having unplugged the power supply cable.



This symbol indicates that the instrument makes use of chemical reagents and other dangerous (corrosive, irritant and harmful) CHEMICAL SUBSTANCES which can cause damages to people and material. When this label is found, pay attention to the producer's recommendations



This symbol indicates that the instrument involves the handling of samples which can be infected (urine and human serum). In this condition INFECTIONS or CONTAMINATION might occur. Pay attention to the general safety warnings when in presence of such biological substances. Use protective clothes, gloves and glasses.



This symbol indicates that damages to the instrument and/or its incorrect results could occur if the given warnings are not respected.



This symbol is to advise that the instrument or part of the manual which is particularly important has to be consulted.

1.2. Intended Use of the Instrument

The instrument is intended to be used in the following working conditions:

- reading of medical substances as specified in the technical data;
- only use the chemical reagents and accessories supplied and/or mentioned in this manual;
- work at room temperature and humidity, according to the specified data;
- do not power the instrument in a potentially explosive environment or at risk of fire.



The instrument has to be used as described in this manual. Any other use has to be regarded as improper.

1.3. Use of the Instrument

The instrument has to be used for the expected purposes and in perfect technical conditions, by qualified personnel, in working conditions and maintenance operations as described in this manual, according to the safety rules.

This manual contains instructions for qualified operators.

- **Qualified User** has to make sure that environmental condition is suitable, the installation is correct, the use and maintenance are proper, according to the general safety rules as well as to the particular precautions described in the manual (although he is not entitled to repair the instrument).
- **Qualified Technician** is entitled to maintain and fix the instrument, according to the instructions received and using the original spare parts.



Alterations of the instrument are prohibited. The user is liable for any instrument improper modification as well as the deriving consequences.

Should the instrument need extraordinary maintenance, ask for **Human Service** or for licensed service centres. The maintenance will be carried out by Specialised Technicians that will be able to fix the instrument using the original spare parts to replace the defective ones.

SECTION 2

GENERAL INFORMATION

2.1. Instrument Description: Purpose and Features

ELISYS 2 (fig.2.1) is an automated instrument designed to carry out tests on microplates by optical density reading. It is able to mix organic samples (by pre-diluting them, if necessary) with reagents and to process up to 2 plates on line.



fig. 2.1

2.2. Manufacturer's Identification Label

Made in EC Manufactured for HUMAN GmbH Germany				
APPAR.:	ELISYS 2		V~220	A 3.5
17300			V~110	A -
Cat.- No	SERIAL N.	FABRICATED	Hz 50÷60	

2.3. Instrument Description

The instrument that is shown in figure 2.2 is composed of:

- Instrument framework and protection lid
- Control system run by electronic parts
- Aspirating and dispensing system
- Mechanical arm carrying a dispensing needle
- Movable photometer and plate washer
- Work area with: two microplate places, a washing basin, reagent trays, a tray for samples and two predilution plates.

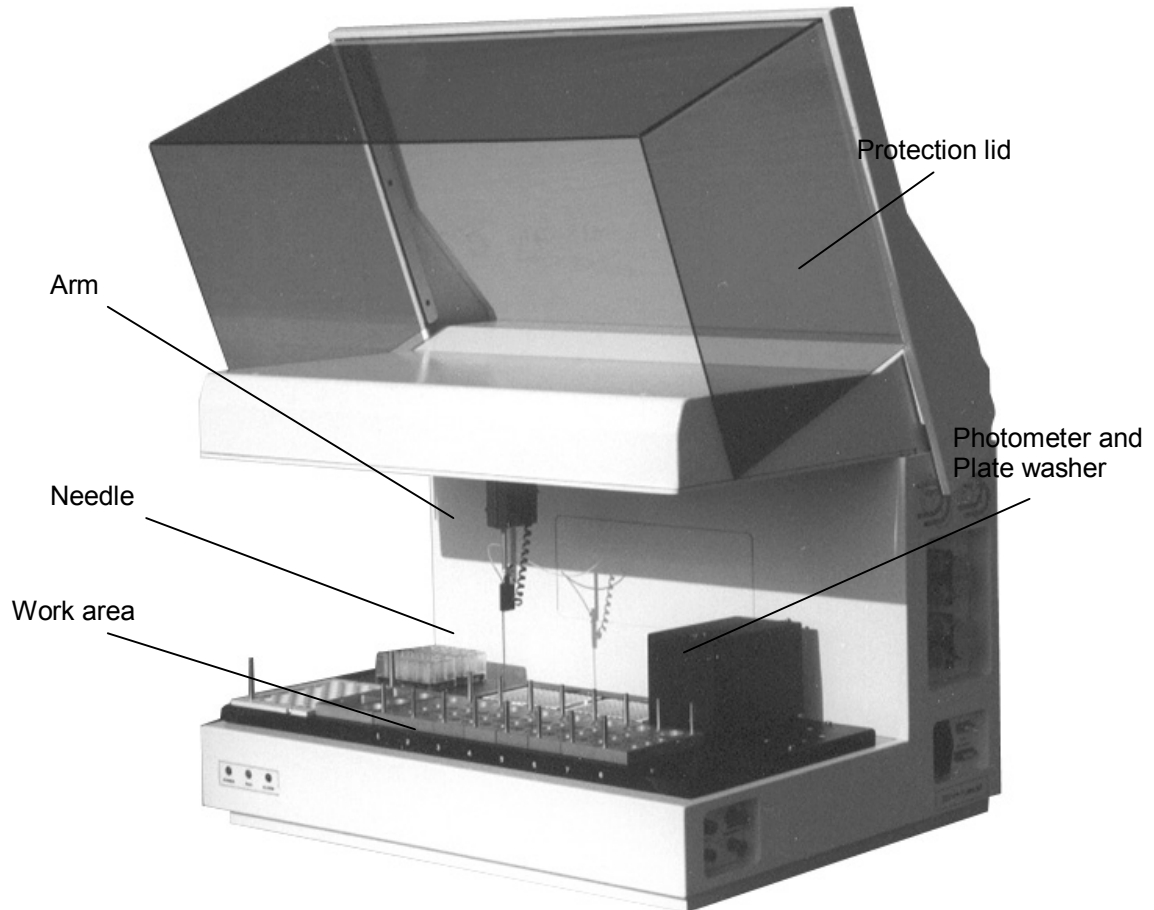

fig. 2.2 Front view (Lid lifted up)

2.4. Instrument Measuring Principle

Below (fig. 2.3) is the diagram representing the main functional elements of the instrument photometric section.

A monochromatic filtered beam of light produced by a lamp goes through the well containing the sample. Part of the light is absorbed by the sample, the remaining one is detected by a photodiode. The photodiode converts the received light in an electrical signal that is once again transformed into frequency. By this frequency the microprocessor calculates the absorbance, taking in account of the blank measure carried out at the beginning. The following is the formula to calculate the absorbance:

$$OD = \text{Log}(\text{blank frequency}) - \text{Log}(\text{sample frequency})$$

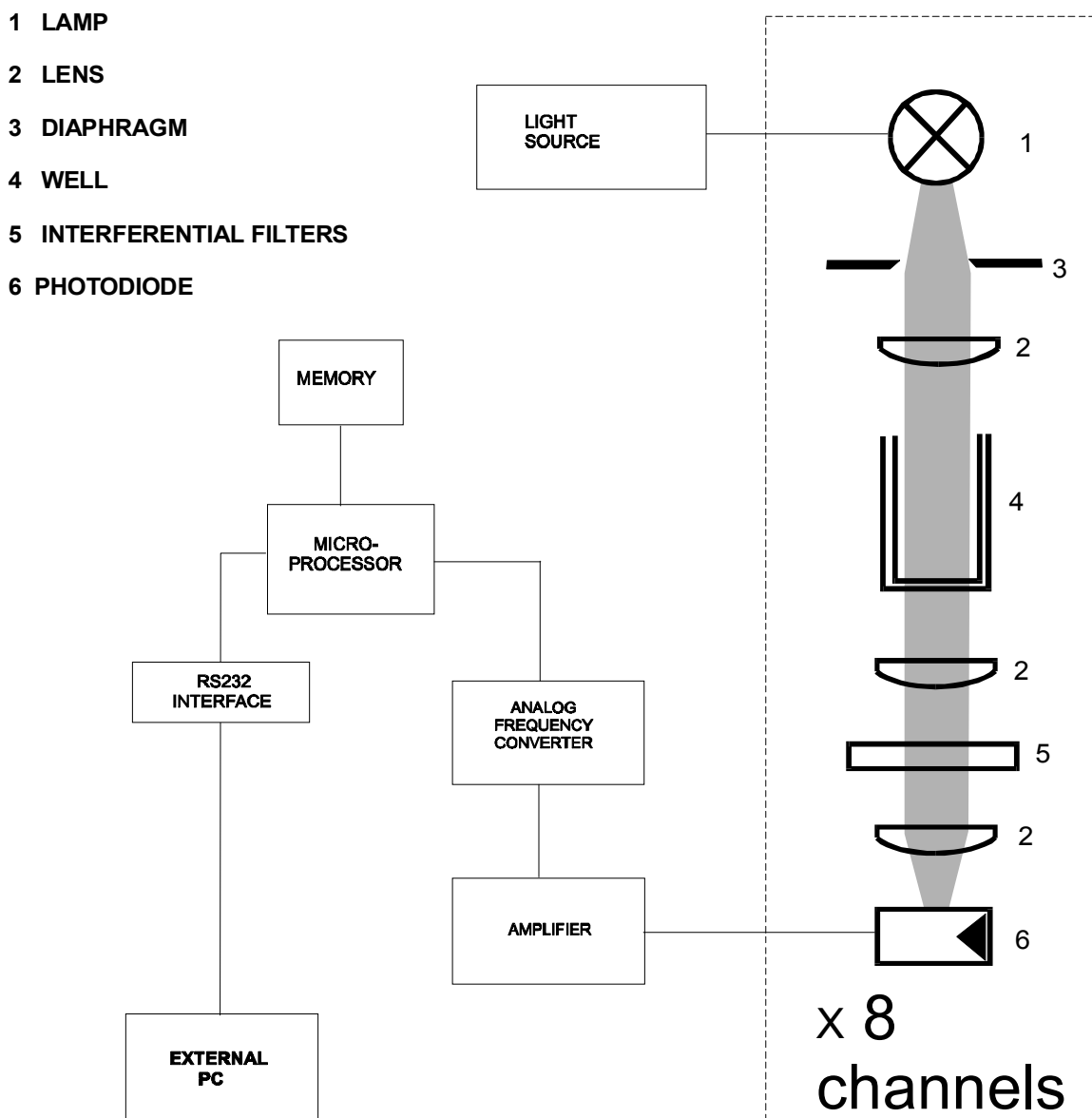

fig.2.3

SECTION 3

INSTRUMENT TECHNICAL DATA

3.1. Main Features

INSTRUMENT AIM

ELISYS 2 is a fully automated analyzer able to carry out up to 8 tests on two microplates.

SAMPLES

Max capacity 40 samples in 16 mm primary tubes or 60 samples in 10 mm primary tubes (optional).
Samples predilution on two 20 well plates, programmable for each assay.

REAGENTS

Modular trays for calibrators, controls, conjugate, chromogen, stop solution, reagents and sample dilution.

REACTION AREA

Max location of 2 microplates with 96 wells each which can be incubated at programmable temperature.

DISPENSATION

An arm with three directions (x, y, z axis) carrying a level sensor dispensing needle.
In the aspiration phase, the sensitive needle stops at liquid meniscus level to reduce contamination.

WASHING

Needle: external surface by dipping it into the washing basin with flowing water;
internal surface by dispensing the washing solution in the washing basin discharge.
Plates: one 8-channel dispensing manifold, able to run two independent washing solutions
one 8-channel manifold to drain a row of wells at one time

OPTICAL SYSTEM

Reader: 8 photometric channels equipped with lenses, interferential filters and lamps.
Results: available at the end of the work session to be stored and printed.

EXTERNAL LIQUID CONTAINERS

External containers are delivered with the instrument to contain washing solutions, dispensing solution and the liquids waste (each container is equipped with a level switch),

SOFTWARE

A PC software, run by WINDOWS '95/'98, allows to:

- set up the requested analysis and to process on line different methods
- give to the instrument the relevant commands
- receive and transfer the analysis result
- print and file the results
- memorise the calibration curves.

3.2. Instrument Technical Specifications (*)

PROCESS CAPABILITY	Combination up 8 assays on 2 microtiter plates on line
WORK AREA	Modular composition:
– Microtiter plates	2 microplates with 96 wells (12 strips, each one with 8 wells)
– Sample tray	one tray for 60 primary tube Ø10÷12 x 100 mm, replaceable with a 40 primary tube Ø14÷16 x 100 mm tray
– Common reagent trays	different types (depending on the assay category), for substrate, stop solution, cleaner, dilution solution bottles, common reagents
– Specific reagent trays	different types (depending on the specific assay), for calibrators, controls, specific reagents
– Predilution plates	2 plates, each one with 20-wells
PREDILUTION	Programmable for each sample,
DISPENSATION	Three freedom degrees Arm (x, y, z axis) carrying the needle
DISPENSATION SYRINGE	
– Total volume	1000 µl
– Minimum volume	10 µl
– Accuracy	Better than 1% at a volume of 100 µl
PIPETTING SPEED	
– Samples	35 minutes for 96 wells for a washing volume of 1 ml
– Reagents	7 minutes for 96 wells for a washing volume of 1 ml
CARRY OVER	Minimised to less than 3% by washing the pipetting system after each single sample dispensing and after each reagent dispensation phase
LIQUID SENSORS	Sample and reagent levels are sensed by the needle used as a capacitive sensor
– Sample dead volume	Less than 150 µl
– Reagent dead volume	Between 100 µl and 400 µl depending on the bottles used
MICROPLATES WASHING	8-channel moving manifold with separate filling and aspiration ports 2 different washing solution to choosing from within a work session
NEEDLE WASHING	External and internal washing
REAGENT WASTE	About 10% (*) of reagent aspirated for all the assays (*) used for cleaning the sampling system
EXTERNAL TANKS	
– Wash buffer 1 and 2	two 2-liter bottles
– Wash solution	a 5-liter bottle
– Waste	a 10-liter tank
	Each one is equipped with a level switch to check whether the tank is full or empty
INCUBATION	At room temperature (Ta) or programmable from Ta+5°C up to 45 °C in steps of 1°C
PHOTOMETER	Moving 8 channel device with automatic blanking and internal calibration
– Light source	Tungsten lamps
– Filters	2 standard interferential filters: 450 and 630 nm, bandwidth 8 nm Other wavelength values on request .Two more optional filters to be added .
– Detectors	Silicon photodiodes
– Measurement range	0.000 - 3.000 OD (Optical Density)
– Accuracy	
from 0.000 to 1.500 OD	± 1% or ± 0.010 OD whichever the bigger
from 1.500 to 3.000 OD	± 2%
– Stability (short term)	0.001 OD in 1 minute

INSTRUMENT TECHNICAL SPECIFICATIONS
(Continued)

SERIAL INTERFACE	RS232
ELECTRICAL POWER REQUIREMENT	Standard 220 or 110 Vac 50/60 Hz
POWER CONSUMPTION	500 W Max
OPERATING CONDITIONS	
Temperature	from +15°C to +30°C
Relative Humidity	up to 80%
SHELF CONDITIONS	
Temperature	from -10°C up to +60 °C
Relative Humidity	up to 85%
DIMENSIONS	
- Width	790 mm
- Height	595 mm (980 mm with lifted up lid)
- Depth	600 mm (650 mm with lifted up lid)
WEIGHT	
- Instrument	72 Kg
- Packed instrument	97 Kg (wooden box dimensions: 89x68x75 cm)
EUROPEAN REFERENCE DIRECTIVES	<ul style="list-style-type: none"> - 73/23/EEC regarding low voltage electrical material - 89/336/EEC regarding Electromagnetic Compatibility - 93/68/EEC regarding the CE mark
HARMONIZED SPECIFICATIONS	<p>STANDARD <u>Safety:</u> EN 61010-1 (1994) / CEI 66-5 "Safety requirements for measurement electrical equipment checking and laboratory use"</p> <p><u>Electromagnetic Compatibility:</u> Emission: EN 55011 (1989) (CEI 110-6) Immunity: EN 50082-1 (1992) (CEI 110-8)</p>
INSTRUMENT OUTFIT	<p><u>The instrument is equipped with:</u></p> <ul style="list-style-type: none"> • User's manual • Mains power cable. • Modular reagents trays (kit) • Two predilution plates • A tray for 40 samples • Two 2-liter bottles for wash buffer 1 and 2. • A 5-liter bottle for wash solution. • A 10-liter waste tank • RS232 PC connection cable • Software for PC to master the instrument • (On request: BDE Installer for Microsoft Windows 98 II.Edition)
PC (optional supply)	<p><u>The PC minimum requirements are:</u></p> <ul style="list-style-type: none"> • Microsoft Windows 95 or 98 (for Microsoft Windows 98 II.Edition you need the BDE-Installer version 1.0) • 15 MB free on hard disk • 1.44Mb floppy driver • RAM 32 Mb • Pentium or compatible processor at 166 MHz • Display adapter standard VGA 640x480 • Printer

(*) The described features can be altered at the producer's discretion without forewarning.

SECTION 4

INSTALLATION AND START-UP INSTRUCTIONS



Installing and setting up the instrument, the safety warnings and general rules described in [Section 1](#) must be observed.



Warning! when moving or lifting the instrument consider :

- INSTRUMENT WEIGHT \cong 80 Kg
- PACKED INSTRUMENT WEIGHT \cong 100 Kg

4.1. Unpacking

The instrument is packed with a plywood box, which can be easily moved by a lifting trolley.

Be careful when placing the instrument onto the work area.

To unpack the instrument follow the instructions as below described:

- Remove the packaging band around the plywood box.
- Lift the plywood box straight up from the bottom plate and place it beside the instrument.
- Remove the packaging band and the protective plastic sheets around the instrument.
- Unscrew the four 10 MA screws fixing the instrument body to the bottom plate of the box.
- Save the empty box and the fixing screws for future transportation.



If the instrument was already in use check for the **DECONTAMINATION DECLARATION** (see Appendix A of this manual).



PLEASE SAVE THE EMPTY BOX ! This box is designed and manufactured for this instrument only and should be used in future transportation.

4.2. Placing the Instrument

The instrument has to be placed on a levelled bench, assuring enough free space around the instrument to allow maintenance operations (35 ÷ 50 cm on the rear and on the lateral sides).

Room temperature has to be between 10 and 30 °C with relative humidity below 80%; protect it from direct sunshine.

4.3. Power Supply

Once the instrument and its outfit have been placed, plug it to the right power source using the supplied cable.

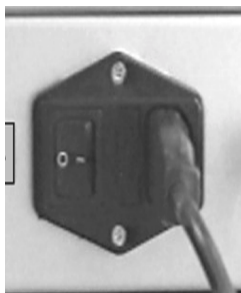

fig.4.1



Warning: make sure that the electrical power source is the one as requested and indicated on the label beside the instrument power socket !

[220 V~ or 110 V~]



Warning: make sure that the fuses value corresponds to the one indicated beside the fuse holder!

220 Vac mains # 2 quick fuses 3.5 A

110 Vac mains # 2 quick fuses 7 A

4.4. Wash And Waste Container Installation

In figure 4.2 are shown the washing/discharging containers and their connections with the instrument.

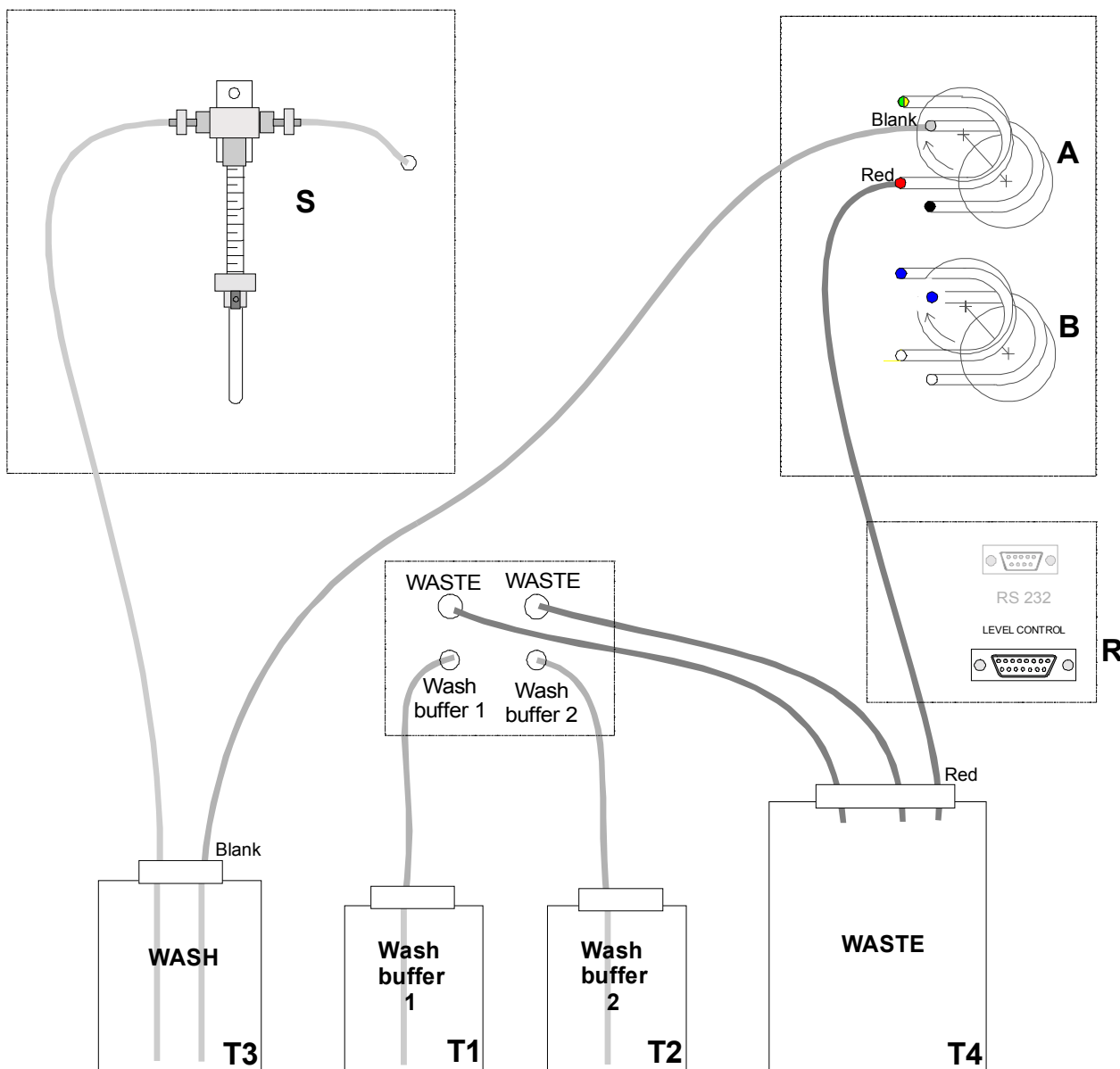

- S Precision Syringe
- A Peristaltic Pump for needle external washing
- B Peristaltic Pump for Microplate washer
- T1 **Wash buffer 1:** bottle for the microplates washing solution (see note 1).
- T2 **Wash buffer 2:** bottle for the microplates washing solution.
- T3 **Wash:** bottle for the needle external washing solution (see note 1).
- T4 **Waste:** tank to collect the waste.
- R Level control connector

fig. 4.2

Before switching on the instrument:

- fill up the T1, T2, T3, bottles with the right solution according to the method requirement
- place the T4 empty container (waste)
- connect the tubing to their relevant container as shown in figure 4.2.
- make sure that the tubing are properly connected and that they are in good condition.
- plug the lead of the level sensor to the instrument socket (connector R).

Note 1 - At the end of a work session, or for scheduled maintenance, the instrument requires a washing cycle. In this case :

- bottle T1 has to be substituted with an equivalent bottle containing distilled water or decontaminating solution for manifold cleaning (see Sect. 6).
- bottle T3 has to be substituted with an equivalent bottle containing decontaminating solution for needle internal and external cleaning (see Sect. 6).

4.5. Work Area

Figure 4.3-a and fig.4.3-b show a typical work area layout.

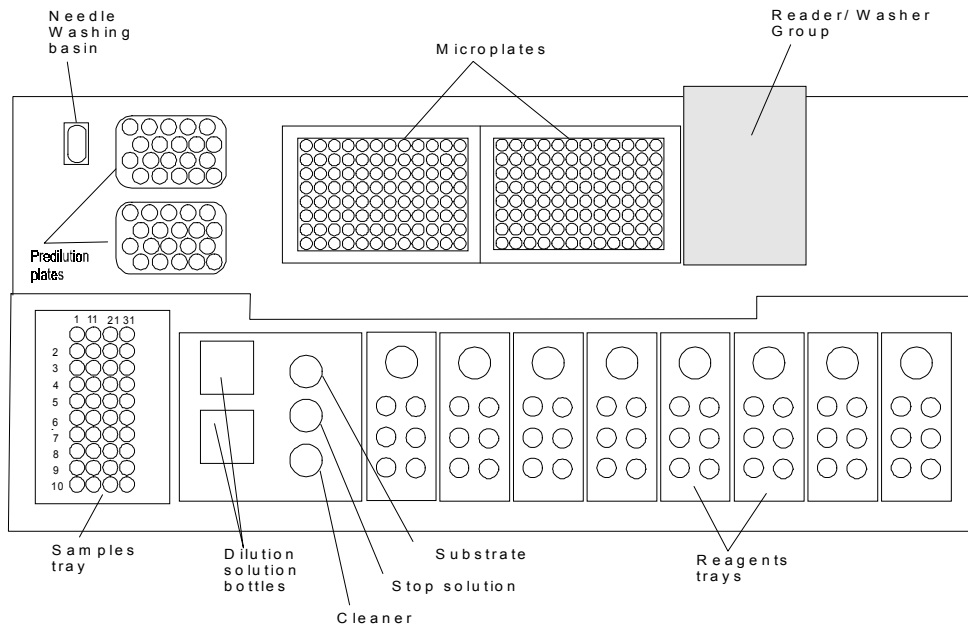

fig. 4.3 - a

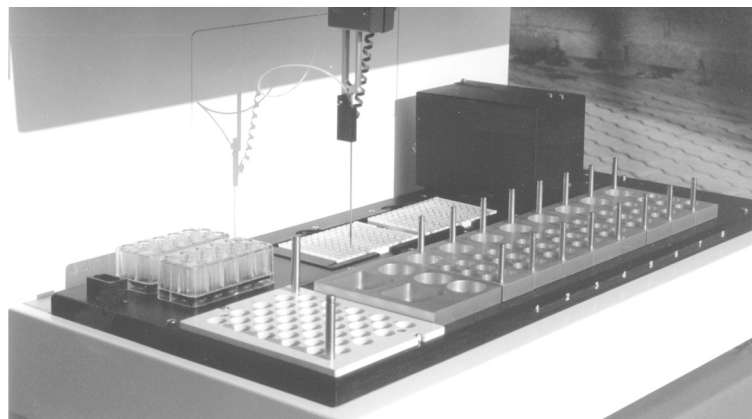

fig. 4.3 - b

4.5.1 Samples Tray

The sample tray is a support for sample vials (primary tubes) to be analysed. The tray may be for 60 primary tubes sized 10÷12 mm in diameter and 100 mm in height (optional) , or 40 primary tubes sized 14÷16 mm in diameter and 100 mm in height. Vials are manually loaded, according to the program instructions (see paragraph 5.3).

4.5.2. Trays for Reagents and Controls

Different types of reagent trays may contain dilution solutions, substrate, stopping solution, cleaner, conjugate, calibrators and controls. Part of them are common for all the assay methods of the session, while other trays contain the reagents for the specific assay methods. The reagent vials have to be placed on particular positions as shown as typical example in fig. 4.3-a and according to the given program instructions (see paragraph 5.3) for the specific assay method.

4.5.3. Pre-dilution Plate

The pre-dilution plate is a molded 20 wells plastic container. The needle dispenses the sample along with dilution solution into each cup according to the running program. There are two pre-dilution plates, so that a total of 40 pre-dilution cups are available. The program advises to locate the pre-dilution plates before starting the process (see paragraph 5.3).

4.5.4. Microplate

The microplate is a support for 96 reaction wells. One or two microplates have to be located on their relevant places.

The washer and the photometer are able to run through the plate in order to read and wash the related wells.

Each microplate can host up to 12 strips, each strip containing 8 wells.

The PC program advises to locate the microplates before the start of the running process (see paragraph 5.3).

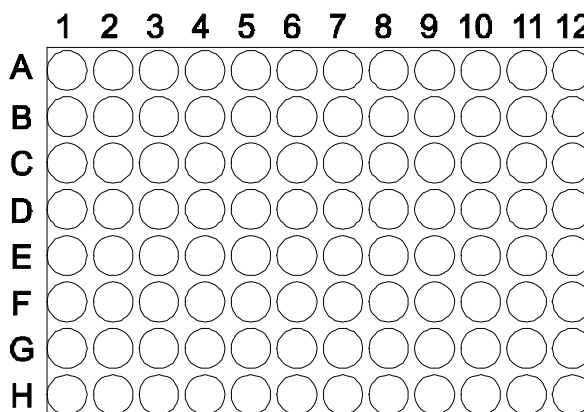

fig.4.3 -b



Warning: to prevent instrument troubles during microplate washing sequence, all the requested strips must be completed with the 8 wells !

4.5.5. Wash Basin for the Needle

In order to wash the external part of the dispensing needle, it is dipped into the wash basin where the washing liquid continuously flows. To wash the internal part of the needle the dispensation liquid is pumped into it.

To prevent samples contamination, the needle washing system is automatically activated, when necessary.

4.5.6. Reader – Washer Group

The reader–washer group is located on the top of the microplates area. It allows to run automatically both the photometric reading and the microplates washing, in succession according to the program.

4.6. Elisys 2 - PC Connection

The instrument is equipped with an RS232 serial port for PC connection.

A 9-pin connector is available on the instrument right side panel (see fig. 4.4).

Generally two serial ports to choose from are located on the rear panel of a PC: COM1 and COM2, a 9-pin male connector and/or a 25-pin male connector.

A connection cable PC- ELISYS 2 with two 9 pin connectors (female- male) is supplied with the instrument. An adapter 9-25 pin may be necessary on the PC side connection.

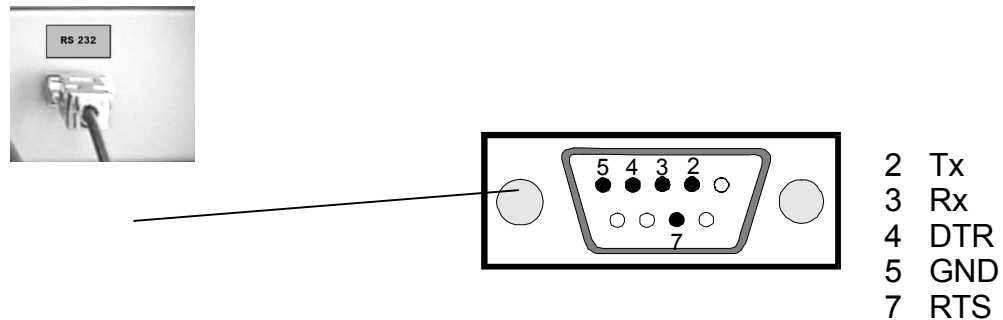

Fig. 4.4 RS232 serial port located at the instrument right side

4.7. Software Installation on PC

4.7.1. PC Minimum Requirements

- Microsoft Windows 95 or 98
- 15 MB free on hard disk
- 1.44 Mb floppy driver
- RAM 32 Mb
- Pentium or compatible processor at 166 MHz
- Display adapter standard VGA 640x480
- Printer .

4.7.2. Software Installation

AP 2 is the program specifically developed for ELISYS 2.

To install AP 2 program on the PC place ELISYS 2 CD in the CD-ROM drive. If the installation program does not start automatically, proceed as follows:

- Start Explorer from the Start menu and select the letter of the CD drive.
- Start the **Setup.exe** program by double clicking with the left key on the mouse.

The installation program is now initialised. Follow the instructions shown on the screen.

The program is now installed and the ELISYS 2 icon is available on the desktop. Double click on it to run the program.



**Remark: For Microsoft Windows 98 II.Edition you need the BDE-Installer version 1.0
(start BDE-Installer also with Setup.exe).**

SECTION 5 OPERATING INSTRUCTIONS

5.1. Introduction



The instrument requires the use of chemical reagents and other dangerous (corrosive, irritant and harmful) CHEMICAL SUBSTANCES which can cause damages. When this label is found, be careful and pay attention to the producer recommendations



The instrument requires to handle samples which can be infected (urine and human serum). In this condition INFECTIONS or CONTAMINATION might occur. Pay attention to the general safety warnings as to the presence of such biological substances. Use protective clothes, gloves and glasses.

In particular:

- Wear protective clothes and gloves.
- At the end of a work Session, clean the work panel and its accessories carefully by using a cloth soaked in a 0.5% sodium hypochlorite solution.
- Waste material produced by the analytical and cleaning process is a dangerous material which might contaminate people and material. Get rid of the waste material according to the local regulations.

5.1.1. Operating Overview

Table 5.1 shows the general operating sequence.

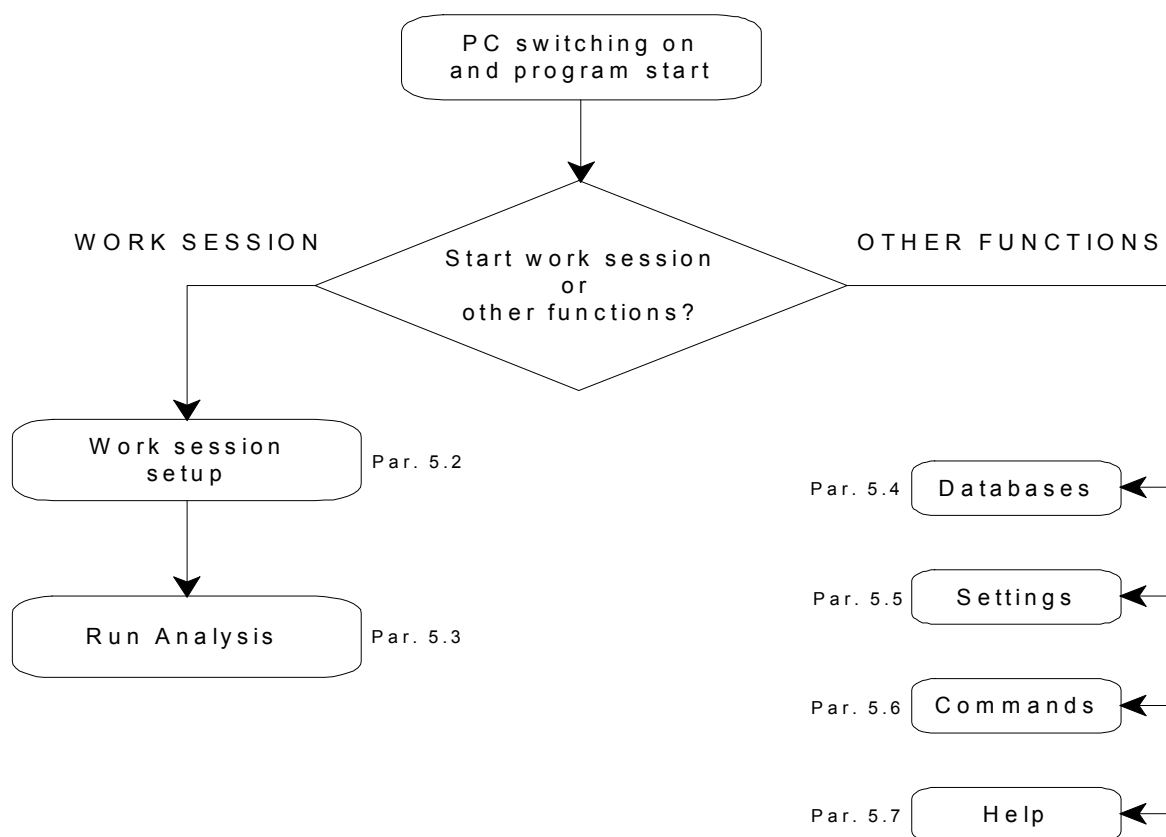

Table 5.1 – General operating flow diagram

5.1.2. Powering the Instrument

Switch on the instrument (the switch is located on the right side).

On the front side of the instrument there are three coloured lamps as below specified:

POWER	<u>green lamp</u>	indicating that the instrument is switched on
RUN	<u>yellow lamp</u>	indicating that the instrument is in running phase
ERROR	<u>red lamp</u>	indicating that no liquid is inside some container of the work panel (Note 1)

Note 1: The machine won't stop, but the display shows the void positions.

5.1.3. PC program starting

The ELISYS 2 icon is available on the desktop. Double click on it to run the program.

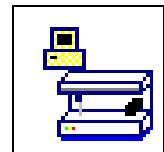

The main menu will appear:

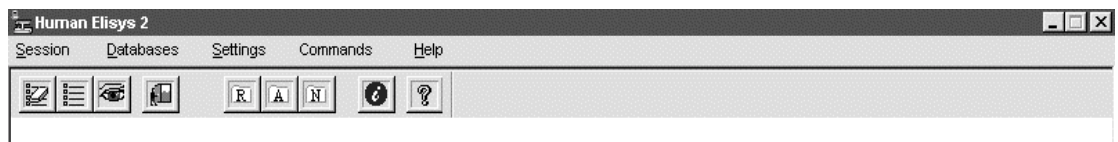

5.1.4. Operating Menu

Tables 5.2 and 5.2a show the instrument operating menus and their function.

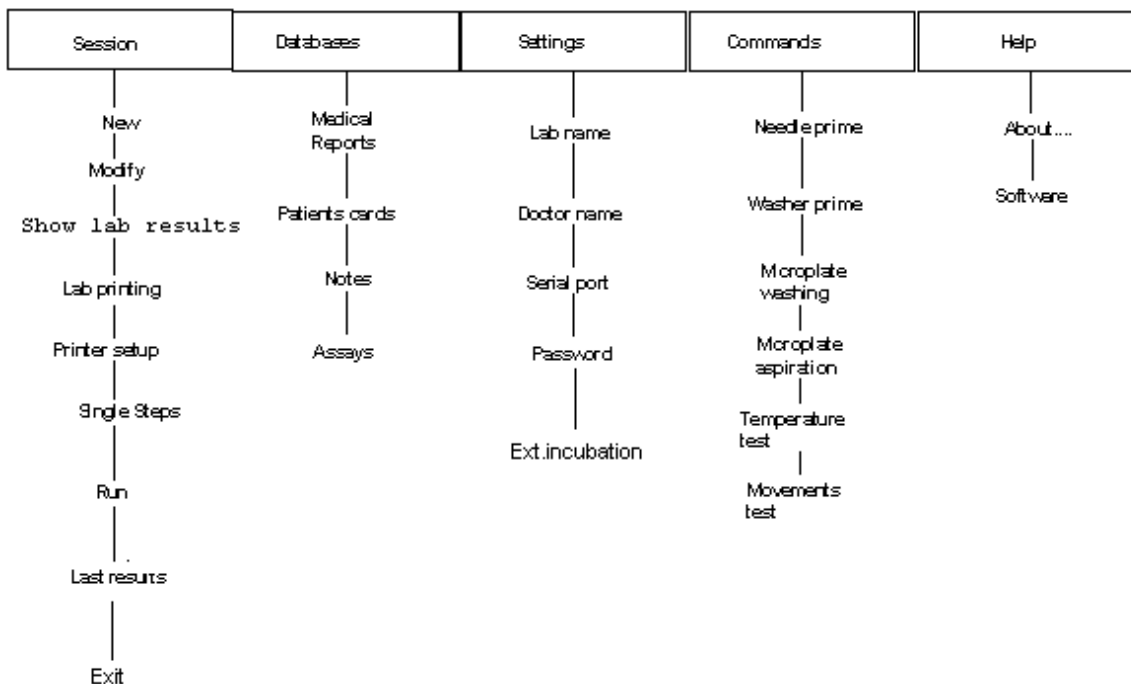

Menu function explanation

Session

New	To start a new work session.
Modify	To modify the setting of the last loaded session, if processed or not. If no session has been programmed, it assumes the New function as the previous paragraph.
Show lab results	Display of existing Labfiles
Lab Printing	To print all the information concerning each analysis session already processed, values for the samples, controls and standards, as well as any mistake if any.
Printer Set-up	To set up the printer
Single Steps	Activates the single steps operation
Run	This command runs the working procedure, if a session has been set up.
Last results display	Activates the display of the results of a processed but not stored working session.
Exit	Exit from the program.

Databases

Medical report	Displays the stored medical reports. They can be accessed or by the patient's name and/or the execution session date.
Patient card	To display, modify and insert the patients in the database.
Notes	To display, modify and insert the sentences frequently used and associated to the notes in the report.
Assays	To display, modify and insert the parameters for each method.

Settings

Lab name	To set the heading to be printed on the lab printing reports.
Doctor's name	To indicate the doctor's name on the analysis report.
Serial port	To choose the serial port or simulation mode
Password	To insert or modify the password.
Ext. incubation	Enables the external incubation function.

Commands

Needle prime	To prime the needle.
Washer prime	To prime the washer.
Micro-plate washing	To set the number of strips to be washed.
Micro-plate aspiration	To set the number of strips to be emptied.
Temperature test	To set the reference temperature and to monitor it continuously.
Movements test	To check the instrument's moving parts and show any bad functioning.

Help

About....	To display all the information concerning that software version.
Software	To display the software interactive guide.

5.2. Work Session Setup

From the *Session* menu, click on *New* to access the *Profiles Selection* window which shows the blank fields.

Remark: Clicking on "New" the memory contents of the application are reset and the previous results and set ups are lost.

From the *Session* menu, click on *Modify* to access the *Profiles Selection* window. The stored setting up of the previous working session can be modified.

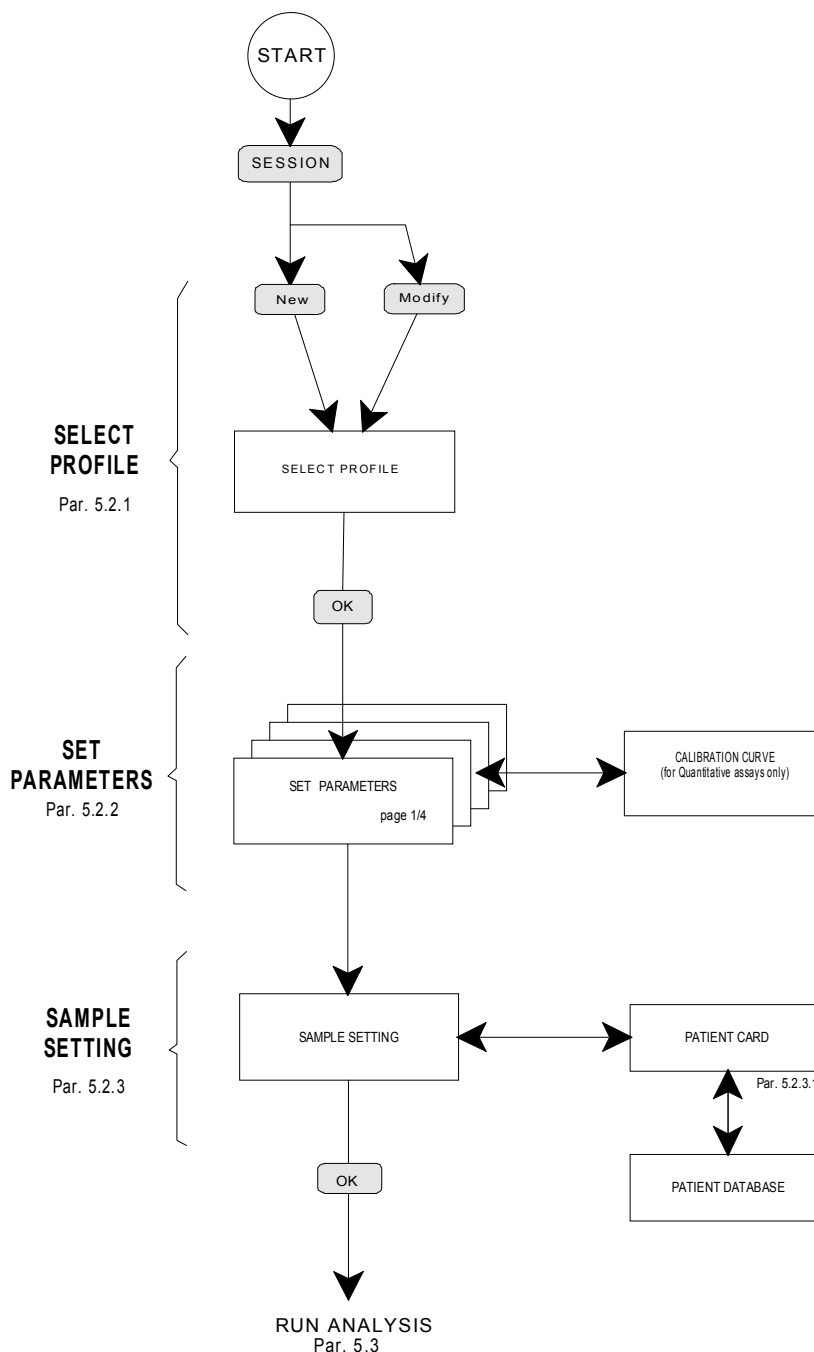

Table 5.3 – Session set-up

5.2.1. Select Profile

A profile is a set of assay methods (maximum 8) to be processed at the same time with the same set of samples.

To recall a message memorised previously, it can be selected in the *Select profile* list on the left side of the window..

By clicking on the *Delete Profile* button, it is possible to erase a profile memorised previously.

Use panel *Sample rack* to choose between operating with a 40 samples or a 60 samples rack.

Once the Assays have been set, press OK to save the profile. This is very useful, when the same type of analysis is run frequently.

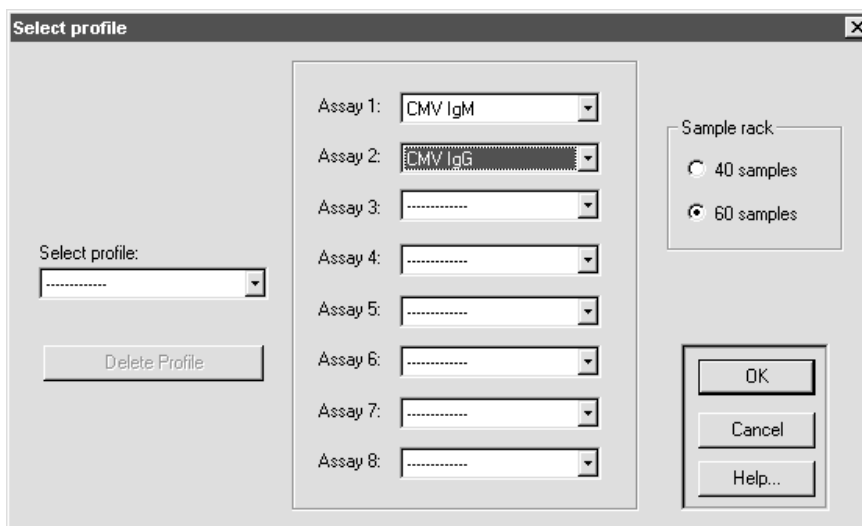

Note: Not all of the methods are necessarily compatible amongst themselves. That means, that it isn't possible to execute methods which present different characteristics in the same session.

E.g., it is not possible to process different sets of methods at the same time, in the following situations:

- more than two washing solutions,
- more than two dilution liquids,
- different incubation temperatures,
- different conjugate or substrate incubation times
-

The program signalsises these incompatibilities and doesn't allow to continue the setting up of a session as long as the operation hasn't been cancelled, or until the incompatibilities have not been removed.

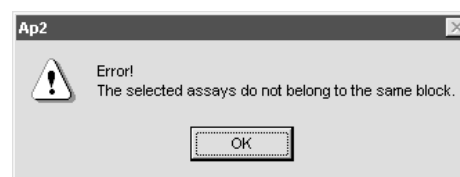

At the end, the program enables to change the sequence of the set methods, in order to:

- reduce the execution time of the session,
- reduce the number of changes of the washing solution,
- minimise (reduce at a minimum) the solution quantity necessary to prime.

In those cases the following message appears to the user, confirming the change.

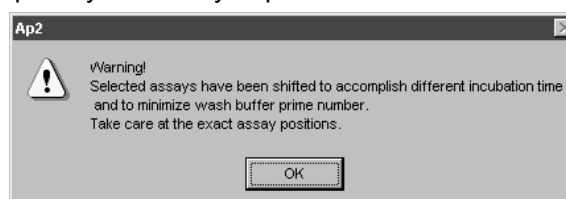

5.2.2. Set Parameters

After clicking OK, for confirmation of each method set in the previous window (*Select profile*), the window *Set parameters* appears (page 1/n).

For each method, it is possible to set the following (*note 1*):

- the repetition of the blanks, controls, samples e of the calibrators, if the execution modality foresees a quantitative analysis,
- the execution modality (qualitative or quantitative (*note 2*)),
- the reagents lot and its expiry,
- the Cut-off factor (*note 3*),
- when to use the controls (at the beginning, at the end, every N samples).

Clicking Next or OK you go on to the next assay method (page 2/n).

Note 1: The program stores latest selected options of the requested method and displays them automatically. In any case it is possible to modify them.

Note 2: The program only allows the execution of the quantitative evaluation method if the corresponding data have been set.

The screenshot shows a dialog box titled "Running parameters" with a close button (X) in the top right corner. The dialog is organized into several sections:

- Assay:** A text field containing "FSH".
- Repetitions:** A section containing three sub-sections:
 - Curve:** Radio buttons for "Single" and "Duplicate" (selected).
 - Samples:** Radio buttons for "Single" (selected) and "Duplicate".
 - Controls:** Radio buttons for "Single" and "Duplicate" (selected).
- Blank:** Radio buttons for "No", "Single" (selected), and "Duplicate".
- Lot:** Text fields for "Lot", "Expiration", and "Cut Off factor" (containing "1").
- Controls:** Checkboxes for "Begin" (checked), "End", and "Every" (with a text field containing "0") samples.
- Execution mode:** Radio buttons for "Qualitative" and "Quantitative" (selected).
- Pag. 1/2:** A small box in the top right corner.

At the bottom of the dialog, there are five buttons: "Previous", "Next", "OK", "Cancel", and "Help...".

Note 3: **Cut Off factor** field.

For most of the methods executed in qualitative evaluation it is necessary to leave this value fix on 1.

There are different methods called semi-quantitative evaluation which use only one known concentration calibrator. In this case the sample concentration is calculated as follows:

$$\text{sample OD} / \text{calibrator OD} * \text{calibrator concentration}$$

To execute this calculation the calibrator concentration has to be set in the CUT-OFF FACTOR field.

Calibration curve

The last calculated curve is displayed in quantitative methods if there are already previous calibration values. The curve plotting is specific for each method.

In any case it is possible to:

- change the axes scale
- decide to evaluate the samples based on memorised values (keep them) or proceed to a new curve calibration (execute new).

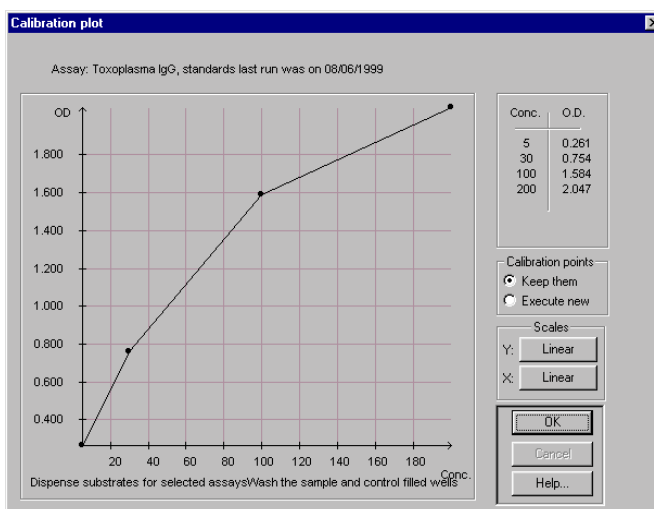

5.2.3. Sample Setting

After the setting of the parameters of each method, the window shown allows to couple the samples with the methods.

This window allows in fact to associate every sample to be analysed with one or more methods present in the selected profile.

Selecting any *Code* field of the window it is possible to use the *Self-increase* key to set a predefined patient code. Further clicks on that button will add a different progressive code for the following patient.

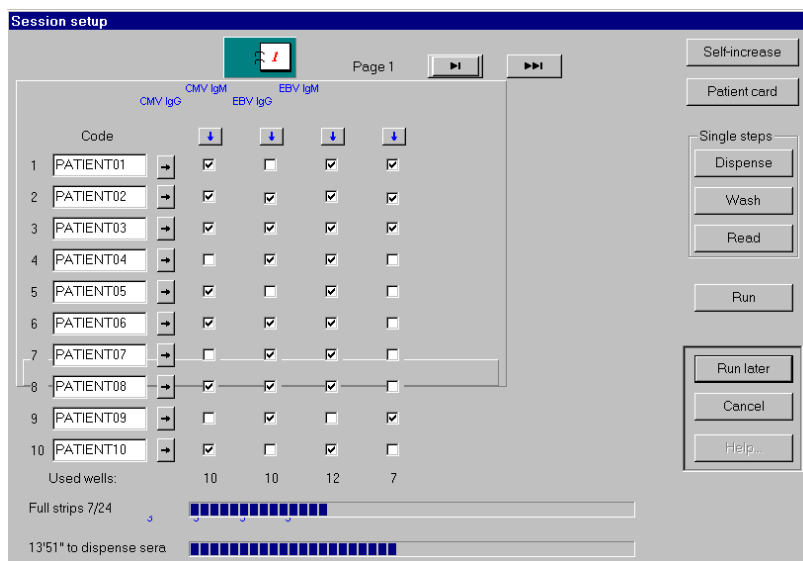

They keys on the right and the left of the page number allow to show following or previous sample positions.

By means of the arrow on the right side of the patient code, you chose that sample for all the analysis. Analogously, using the arrow under the method name, all the samples appearing on the page are chosen for this type of analysis.

It is possible to select one by one the coupling of the sample and the method, by clicking on the box at the centre of the window.

The current number of the used wells is shown under each column related to the method.

At the bottom of the window there are two fill-up indicators. The first one is referred to the presently occupied strips, the second one to the necessary time for the dispensing of the samples, controls and calibrators for the session. (Note 1)

Note 1: The session is automatically divided in various runs if the total sample dispensation time is longer than the sample incubation time of the first method.

The program advises the user and disables the selection if the maximum of the pre-dilution cups (40) or the strips (24) is reached.

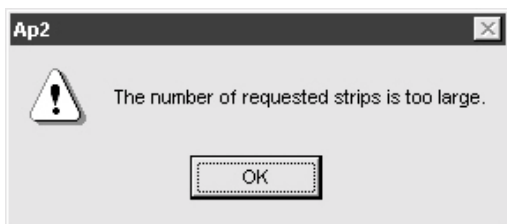

Clicking on *OK* the session is memorised with the actual settings.

Clicking on *Run* the working session begins to run (*Note 2*). [See Par. 5.3]

5.2.4. Single Step Operation

To run an assay in a sequence of distinct phases, or just a specific phase, select *Single steps* under the item *Session* of the main menu.

A window will appear for the assay set-up, similar to that of par. 3.2.3, but with three additional buttons to allow the selection of the desired phases in single steps.

In this mode of operation, after each phase (steps), the machine stops, waiting the command to go on to the following phase (step).

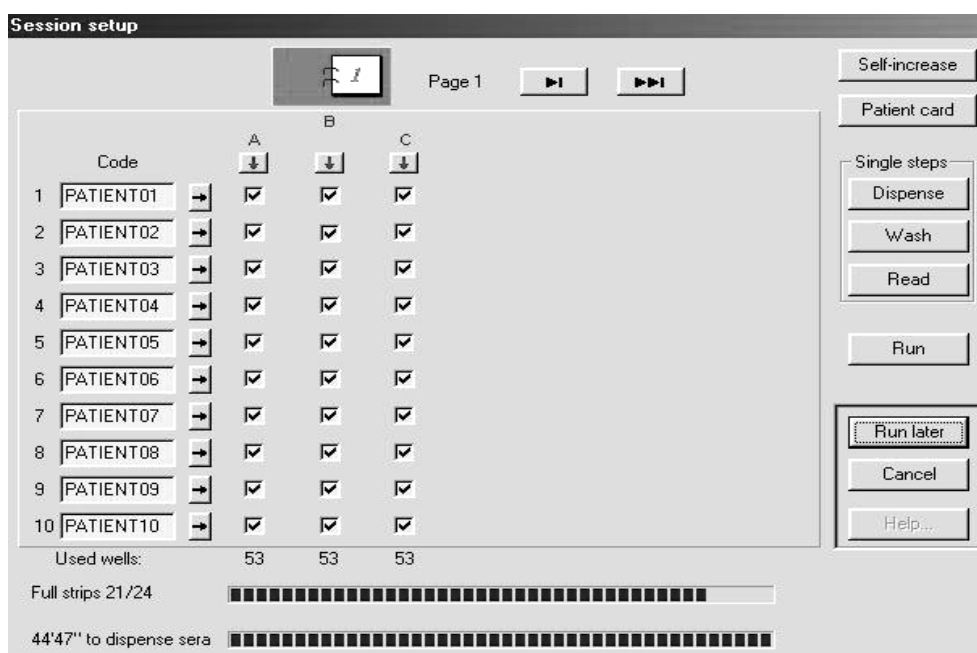

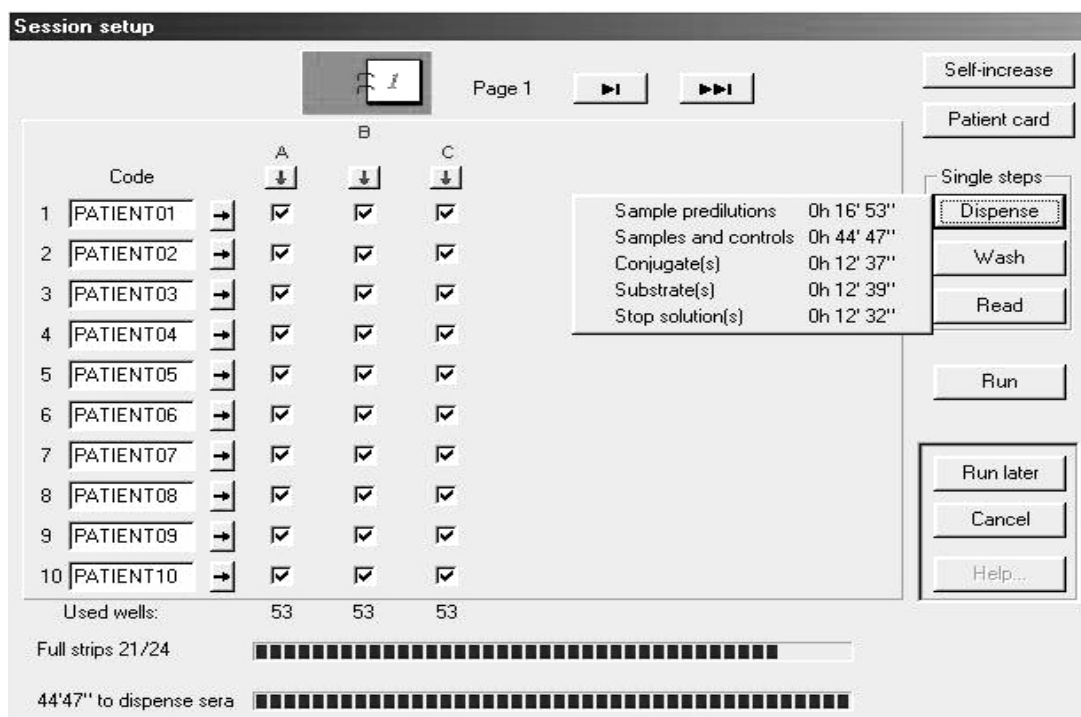

Dispense		Pressing this button the following menu appears:
1	Samples predilutions (0h 16' 53")	Selecting this item, the machine will execute the sample predilution, in accordance the selected assay settings.
2	Samples and controls (0h 44' 47")	Selecting this item, the machine will execute the dispensation of the samples and controls, in accordance to the selected assay settings.
3	Conjugate(s) (0h 12' 37")	Selecting this item, the machine will execute the dispensation of the conjugate in accordance to the selected assay settings.
4	Substrate(s) (0h 12' 39")	Selecting this item, the machine will execute the dispensation of the substrate in accordance to the selected assay settings.
5	Stop solution(s) (0h 12' 32")	Selecting this item, the machine will execute the dispensation of the Stop solution in accordance to the selected assay settings.

Note1: In phases 1, 2, 3 the machine does not consider the incubation times programmed for that assay. For this reason the operator shall apply directly the necessary incubation time for each, using a stop watch or a timer.

Note2: The timer indicated for each phase is the expected duration of that phase.

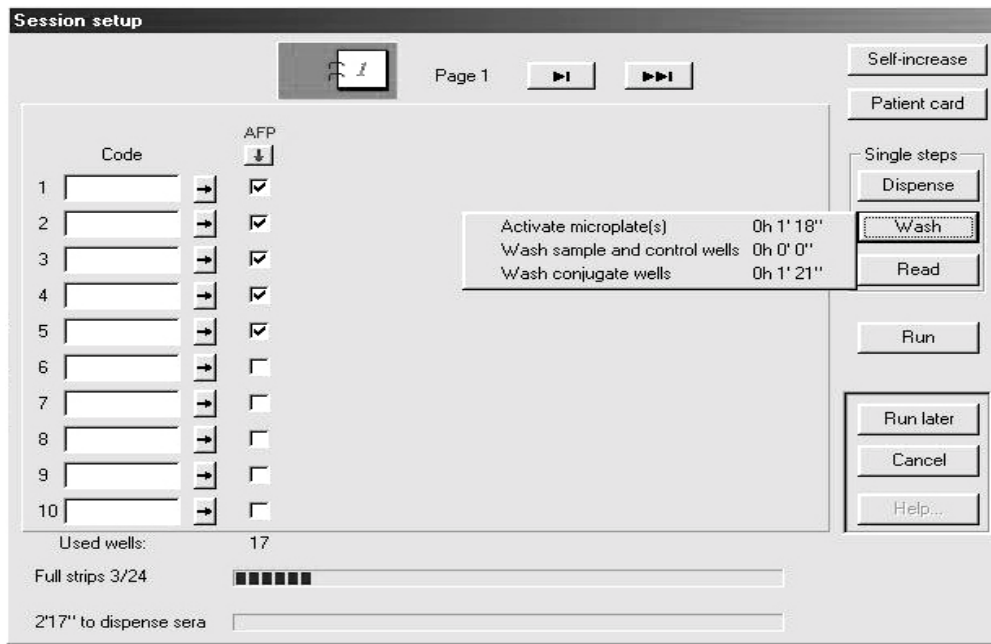

Wash		Pressing this button the following menu appears
1	Activate microplate(s) (0h 0' 0")	Selecting this item, the machine will execute the activation of the microplate(s), respecting the previously set time
2	Wash sample and control wells (0h 15' 24")	Selecting this item, the machine will execute the first washing cycle respecting the previously set time.
3	Wash conjugate wells (0h 12' 39")	Selecting this item, the machine will execute the second washing cycle respecting the previously set time

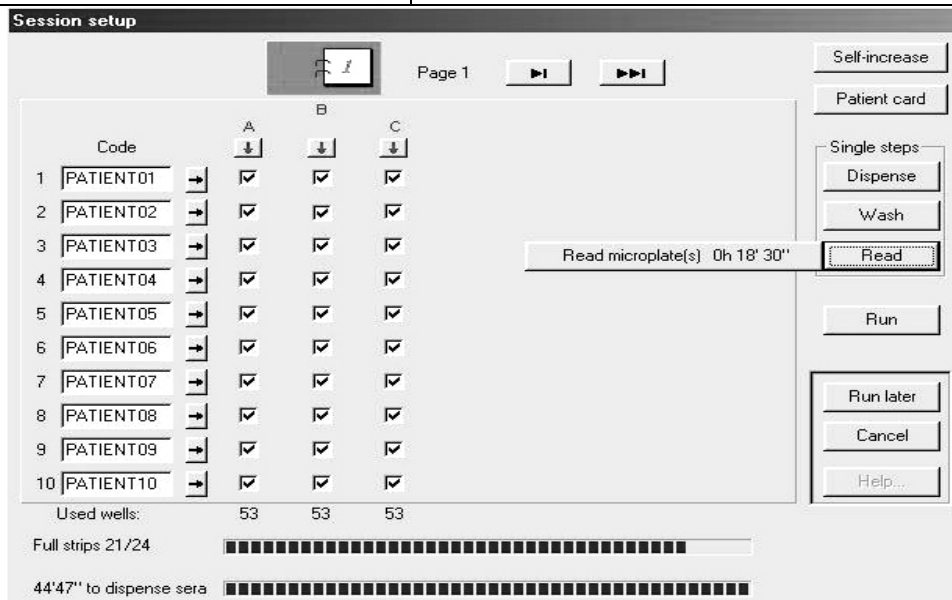

Read		Pressing this button the following menu appears:
1	Read microplate(s) (0h 15' 10")	Selecting this item, the machine will execute all the reading and will show all the result, with the possibility to print the laboratory file and the results.

5.2.5. Entering the Patient Card

It is possible to couple each sample to a patient report, selecting the *Code* field in the window and clicking on the *Patient card* button.

In the window which appears, information regarding the patient and the sample can be inserted.

To accept the information given, the following boxes must at least be filled in: *Patient-ID*, *Group*, *Name*, *Birth day*, *Sample date e Time*.

Patient's information already stored in the database, can be accessed by clicking on the *DataBase* button and by selecting the patient's name amongst the ones present in the file.

The card can also be filled in and the information registered in the database. This allows to memorise the information of patients which have to be checked often.

In this case the program asks which operation to carry out.

More information about the patient chosen can be inserted by using the button *More Notes*.

There can be inserted up to 5 additional comments.

In this case the *DataBase* button can also be used, proceeding equally as explained previously.

5.3. Run Analysis

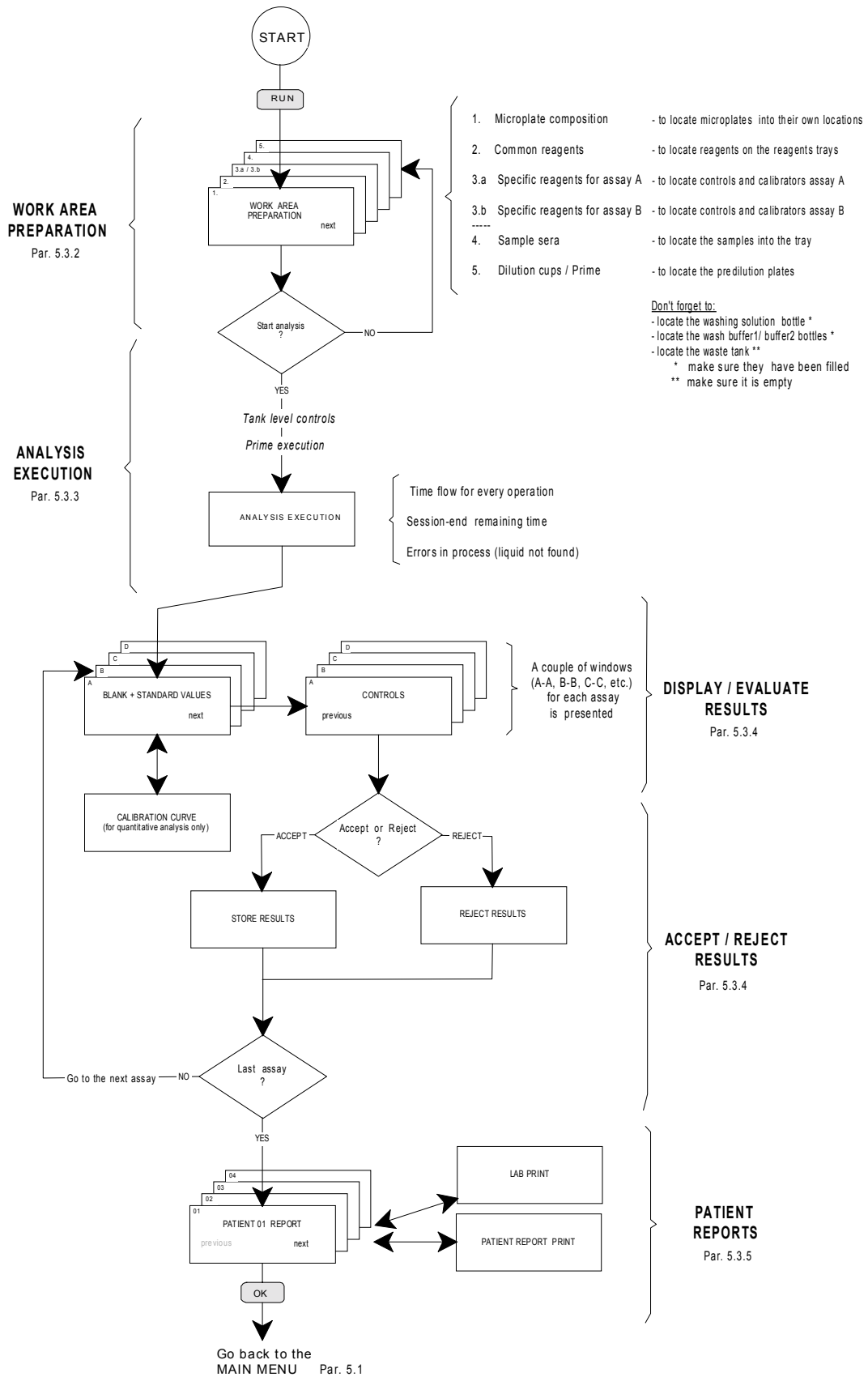

Table 5.4 – Run assays sequence

5.3.1. Run the Process

From the **Run** button of the patient selection window during the setting of the session, or from the RUN voice of the menu Session, it is possible to start the execution of the working session.

5.3.2. Work Area Preparation

5.3.2.1. Microplate composition

The first window shown is a summary of the set methods and an overview of the composition of the microplates.

It shows the strips used for each method and in which execution they are carried out.

Prior the test performance the strips always have to be filled up. It must be guaranteed that all positions for each strip are occupied with wells. Otherwise during the wash process water will spill inside the instrument.

These positions are marked as neutral wells.

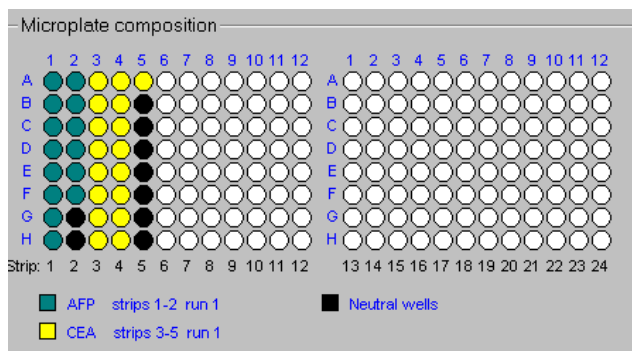

5.3.2.2. Common reagents

The next window shows the display of the common tray where the necessary dilutors, wash solutions, stop-solution and substrate must be arranged for all the methods to be processed in the session.

Note: Different trays can be used for method sets which require a different configuration.

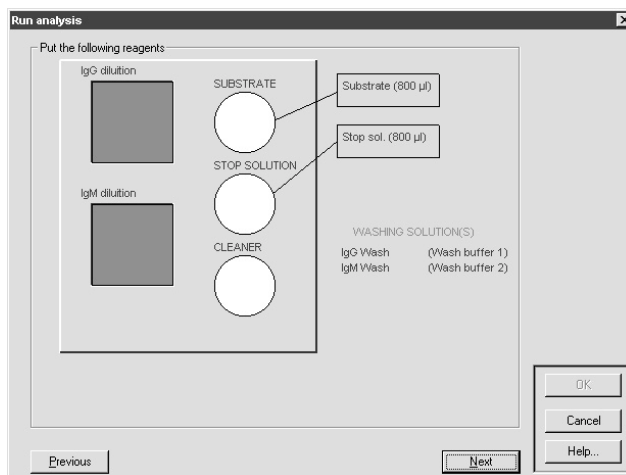

5.3.2.3. Specific reagents for assay A, B..

The following windows show the arrangement of the reagents, wash solution, dilutors, controls, calibrators for each method foreseen in the session.

Assay A

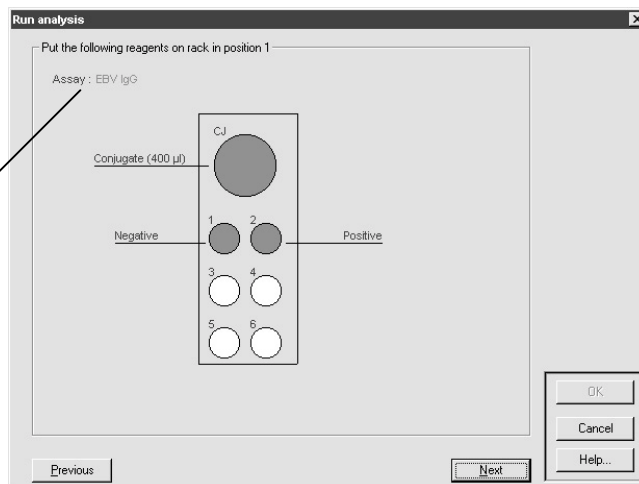

5.3.2.4. Sample sera

The window below shows the disposition of the samples on the sample rack.

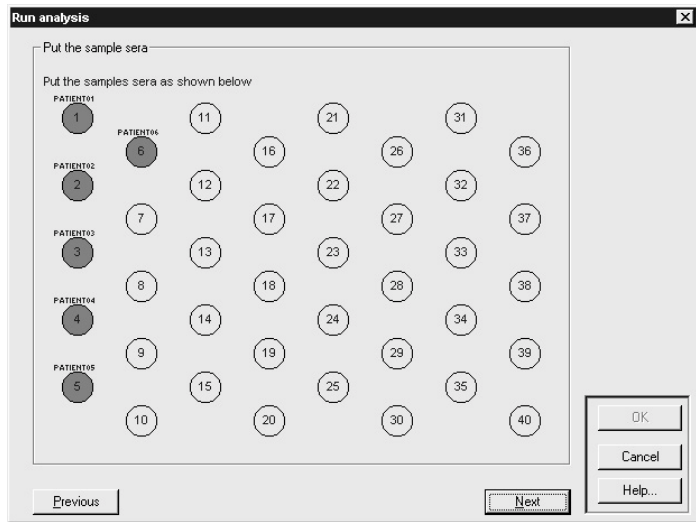

5.3.2.5. Dilution cups

The number of pre-dilution cups necessary for the session is indicated subsequently.

Before starting make sure the machine has been primed!

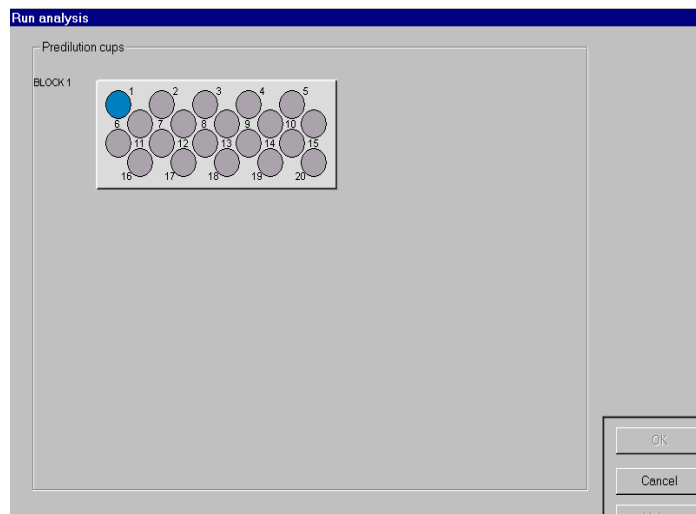

5.3.3. Analysis Execution (Running Phase)

Before the start of the working session:

- the levels of the tank liquids are automatically controlled; there might be warnings for the user with respect to tanks which are or too empty or too full.
- a priming is performed by default, if selected.

While analysis are being carried out, the window will show :

- a *Pause* button to interrupt the process
- a window box to display the errors during the process (the most common: liquid not found),
- two indicators showing the passed minutes and the remaining time to the end of the work Session.

5.3.4. Displaying the Results and their Acceptance Evaluation

The results are shown at the end of the analysis process. For each method there appear two windows.

On the first page the values of the blank are reproduced. They can be excluded from the evaluation removing the selection in the corresponding control box.

Also the standard values can be excluded from the calculation by marking the corresponding checkbox.

On duplicate determination it is possible to exclude only one value by marking the corresponding value directly.

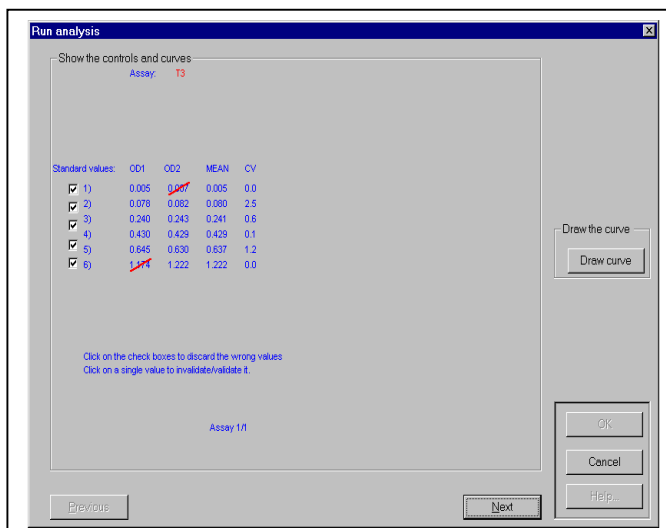

If the method has been executed in quantitative evaluation the calibrator results are shown too.

In this case it is possible to visualise the curve corresponding to the results pressing on the box *Draw curve*'.

If you press the *Next* key, the second window is shown, where the results of the set controls are visualised.

Note: Whenever a double dispensation is chosen, the display shows the two measured absorbances, their average and CV.

It is possible to exclude the obtained values removing the selection in the control fields located on their left.

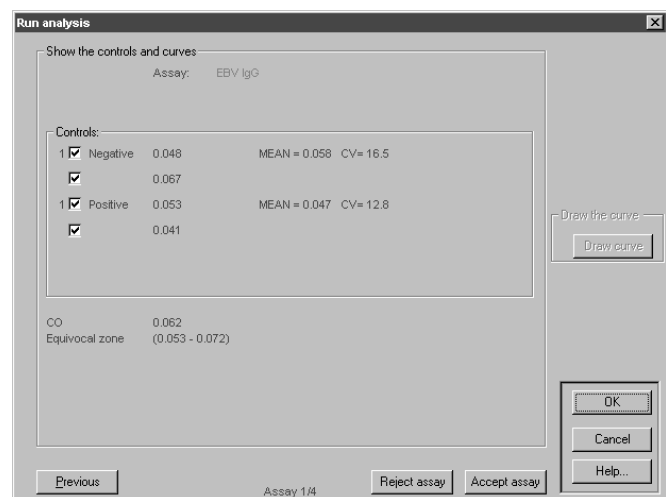

Depending on the values displayed and which might have been modified, it is possible to accept or reject the results of the examined method pressing the buttons

Accept assay' or *Reject assay*'.

NOTE:

- the *Previous* button allows to display again the window related to the blank and the calibrator.
- the *Cancel*' button allows to escape from the visualisation phase of the results without accepting any analysis,
- the *OK* button is not active until all the methods have been accepted.

5.3.5. Patient Reports

In the "Show the results" panel appear the patient data and the results of the executed tests:

- The average and CV are displayed if the test has been executed in double mode.
- Qualitative tests show the cut-off value and the test results (positive, negative or equivocal)
- Quantitative tests show the concentration.



Next' or Previous' by means of these two buttons can be displayed all the Work Session reports

Laboratory' executes the laboratory print

Report' prints the displayed report

All reports prints all the requested reports

Patient data allows to insert or modify the patient's data and the associated notes in the report (See paragraph 5.2.3.1)

Delete analysis' to delete a specific sample result to avoid its memorisation and print out
(Note 1: It is possible to delete a test, but to modify its result)

OK' accepts and stores the data of all the patients of the present working session. The filed data cannot be altered any more.
(Note 2: Attention! Only the data related to the patients with a filled in patient data card are memorised)

Cancel' no report of the present working session is filed.

Note 3: However all the data remain in the memory until a new working session starts. They can be displayed again by selecting the option "View test results" from the Session Menu.

5.4. Databases

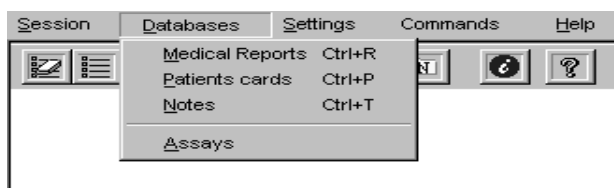

The following databases are available with the program:

- a) Medical reports Contains all the stored medical reports for each patient.
- b) Patient card Contains the stored patient's data.
- c) Notes Contains useful sentences used in the report comments.
- d) Assays Contains the parameters for each method.

NOTE:

It is possible to consult, modify and add elements to all the databases with exception of the Medical Report database.

5.4.1. Medical reports

The window lists the filed patients with at least one report.

Select a patient and press Show to display the list of his reports.

Press delete to eliminate the selected Records.

Note: to use this function the patient card has to be filled in first.

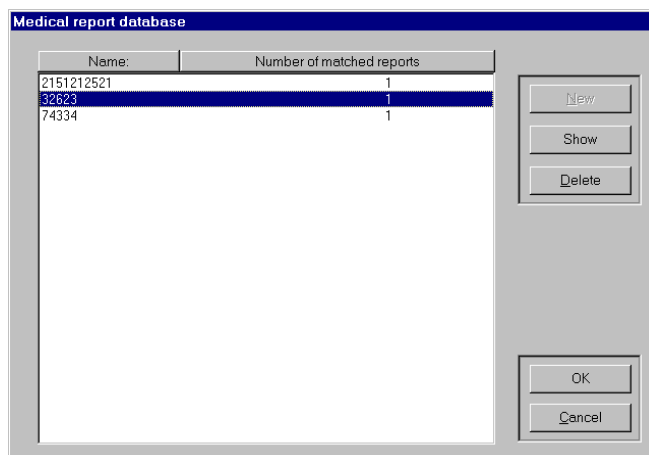

The displayed reports appear with their date and hour of the executed sessions. This helps to select the report to examine.

Select a report and press PRINT to print out the report.

Select a report and press OK to enter the following window which displays the contained data.

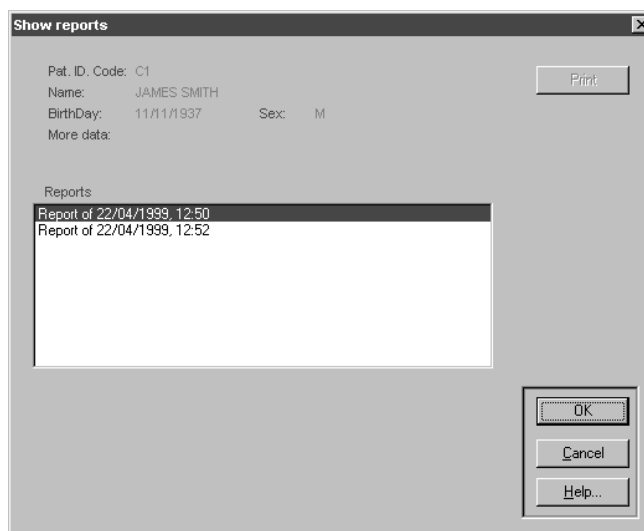

The medical report of the patient for the selected session is displayed.

The report can be printed out by pressing the *Print*' button.

By pressing OK the previous window is displayed.

CANCEL goes back to the main menu.

The 'Show reports' window displays patient information and assay results. The patient's name is JAMES SMITH, born on 11/11/1937, male. The assay results are as follows:

Assay:	OD	INDEX	RESULT / CONC.
EBV IgG	0.048	1.846	Positive
CMV IgG	0.043	0.581	Negative
HSV2 IgG	0.004	0.459	Negative
CMV IgM	0.065	1.240	Positive

Buttons: Print, OK, Cancel, Help...

5.4.2. Patient Cards

This voice allows you to display or modify the patient data stored in the database.

By means of the first window it is possible to display the content of the file and to select the data you are interested in.

Patients can be deleted from the database by selecting them and pressing on the *Delete* button.

New and *Modify* enter the "Patient card" window.

The 'Patient cards database' window shows a table with columns for Group and Name. The current entry is 'Inf' and 'JAMES SMITH'. Buttons: New, Modify, Delete, OK, Help...

New. creates a new patient card in the file.

Modify. allows to modify the stored patient card data.

Both buttons have access to a window where patient data can be entered. This window is similar to the one described in the working session settings (paragraph 5.2.3.1).

The 'Patient card' window contains the following fields: Patient ID: C1, Group: Inf, Name: JAMES SMITH, More data: (empty), Birth day: 11/11/1937, Sex: M F. Buttons: More notes..., OK, Cancel, Help...

5.4.3. Notes

This database contains a number of useful phrases used to comment the medical reports.

It uses the same commands and mechanisms outlined previously.

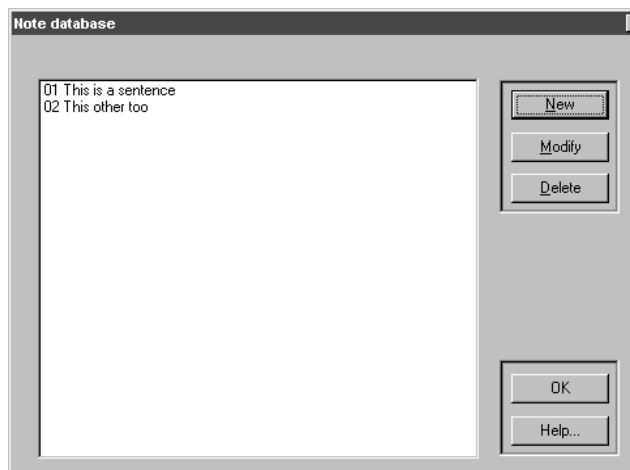

5.4.4. Assays

This database contains all the necessary information to run the assays.

As the information contained in this database is of vital importance for the correct functioning of the instrument, this file is protected by a password.

The access is only recommended to the personnel with a thorough knowledge of the functioning of the program and the instrument.

Once the password has been entered selection window of the assays is displayed.

New allows to add assays.

Copy can be used to copy settings from the selected tests into a new one. The name of the new test has to be different from the source

Save allows too store the selected test On a floppy disk or in a different directory on the harddisk

Load enable to upload tests from a floppy disk or from another directory.

Modify displays and modifies the settings of stored assays.

Delete cancels a stored assay.

Print enables a complete printout of all data related to the selected tests.

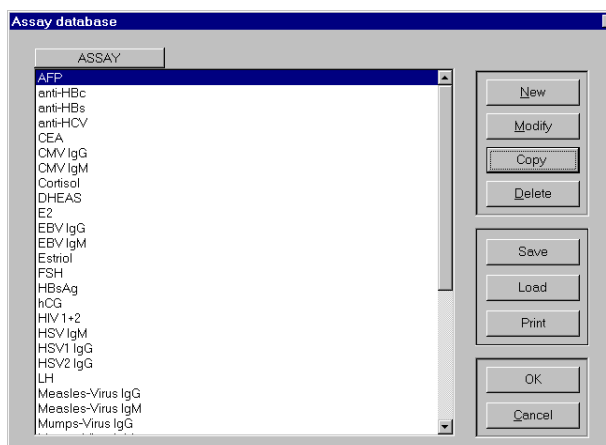

It is recommended NOT to modify any setting if you do not have a sufficient knowledge of the functioning of the program and the instrument.



5.5 Assay Parameter Setup

This window allow to set the parameters of a new method.

The screenshot shows the 'Assay parameter settings' dialog box with the following fields and buttons highlighted by numbered callouts:

- 1**: Block number (dropdown menu)
- 2**: Group par. (text input)
- 3**: Rack type (dropdown menu)
- 4**: Name (text input)
- 5**: Serum (text input)
- 6**: Volumes (µl) section containing Sample, Conjugate, Substrate 1, Substrate 2, and Stop sol. (dropdown menus)
- 7**: Conjugate washing (dropdown menu)
- 8**: Conjugate incubation (dropdown menu)
- 9**: Stopping (dropdown menu)
- 10**: Filters (nm) section containing Filter 1 and Filter 2 (dropdown menus)
- 11**: Thermostat (checkbox and temperature dropdown)
- 12**: Standing time for solution (seconds) (text input)
- 13**: Notes (text area)
- 14**: Quantitative parameters button
- 15**: Qualitative parameters button
- 16**: Working parameters button

1	<p>Block number:</p> <p>Identifies the assays that can be processed in the same run.</p> <p>The following aspects are the limits to process assays in the same run:</p> <ul style="list-style-type: none"> - not more than two washing solutions, - not more than two dilution liquids, - no different incubation temperatures, - no different conjugate or substrate incubation times <p><u>Note 1:</u> If two assays are required to be processed in different runs, it is sufficient to assign them two different block numbers.</p>
----------	--

2	Group parameter:
<p>Identifies the execution modality of the method as far as concerns the modality for:</p> <ul style="list-style-type: none"> - pre-dilution (if any) - sample dispensation - conjugate dispensation - substrate dispensation - stop solution dispensation <p>The new assay method has to be classified within an existing group, in order to utilise the already defined parameters typical for that group</p> <p><u>Note:</u> in Appendix 1 to this document the Groups already defined are listed.</p>	
3	Rack type:
<p>Identifies, by a numeric code, the types of racks (specific and common) to be used for the method.</p> <p> <i>Note: if the Universal racks are used, set to “6” the rack type code.</i></p>	
4	Name:
<p>Field to be filled with the name of the assay to be set.</p>	
5	Dilution:
<p><u>Serum volume:</u> quantity of aspirated sample in μl</p> <p><u>Dilution volume:</u> quantity of aspirated dilution solution in μl</p> <p>The ratio between <u>Dilution volume</u> and <u>Serum volume</u> represents the <i>Predilution Ratio</i>.</p> <p>Es. <u>Serum volume</u> = $10\mu\text{l}$</p> <p style="padding-left: 40px;"><u>Dilution volume</u> = $1000\mu\text{l}$</p> <p style="padding-left: 40px;"><i>Predilution Ratio</i> = 1:100</p> <p> <i>The volumes specified for the serum and the dilution solution present indicative quantities of the dilution ratio volumes foreseen in the method. The program controls automatically that the pre-diluted volume is slightly superior to the minimum necessary to execute the session. If it is not necessary to pre-dilute the sera for the method it is sufficient to set the serum volume on “0”.</i></p> <p><u>On Fly</u> : Dilution with a low dilution rate can be performed directly. No dilution segment is needed in this case.</p>	
6	Volumes
<p><u>Sample:</u> quantity of aspirated diluted sample in μl</p> <p><u>Conjugate:</u> quantity of aspirated conjugate in μl</p> <p><u>Substrate1:</u> quantity of aspirated substrate in μl</p> <p><u>Substrate2:</u> quantity of aspirated substrate in μl</p> <p><u>Stop solution:</u> quantity of aspirated stop solution in μl.</p>	

7	Wash cycles
<p><u>Sample washing</u>: number of wash cycles on the strip after sample dispensation</p> <p><u>Conjugate washing</u>: number of wash cycles on the strip after conjugate dispensation</p> <p><u>Volume</u>: quantity of washing solution in μl</p> <p><u>Empty wells at the end</u>: if the box is checked, empty wells at the end of the washing cycles will result.</p>	
8	Incubation time
<p>Incubation time in minutes for sample, conjugate, substrate.</p> <p>The tree selected values are to be compatible with the block number characteristics.</p>	
9	Reagent name
<p><u>Dilution</u>: editable name of the dilution liquid.</p> <p><u>Stopping</u>: editable name of the stop solution.</p> <p><u>Wash solution</u>: editable name of the wash solution.</p> <p>It is obligatory to fill the three fields.</p> <p>The three “names” are used by the program to check that, in the selected work session profile, no more than 2 different dilution buffer or no more than 2 different wash solution are present. If these condition are not met the program does not accept the selected profile</p>	
10	Filters
<p><u>Filter 1 (nm)</u>: Select the type of primary filter (es. 450 nm)</p> <p><u>Filter 2 (nm)</u>: Select the type of secondary filter (es. 630 nm).</p> <p>If the secondary filter is not selected the program will perform only a monochromatic measure.</p>	
11	Thermostat.
<p><u>Thermostat</u>: if the box is checked, the thermal regulation is active.</p> <p>In the near box the temperature value in $^{\circ}\text{C}$ has to be selected.</p>	
12	Plate prewashing
<p>If the box is checked, the micro plate prewashing is active.</p> <p>In the near box the standing time for solution in seconds has to be selected.</p>	
13	Notes
<p>It is possible to write comments and memoranda related to the assay.</p>	
14	Quantitative parameters
<p>See next pages</p>	
15	Qualitative parameters
<p>See next pages</p>	
16	see 5.5.1 Working parameters
17	

Using the *Quantitative parameters* button it is possible to set the data regarding the following:

- calibrator concentrations for the method,
- curve type to be designed for the sample evaluation,
- normally expected values,
- concentration measuring unit.

Note 1:

In case the method requires only one calibrator with a known concentration (semi-quantitative analysis), it must not be introduced in that window. (See Cut-off calculation par. 5.4.4.1)

Note 2:

Remember: the drawing of the Log-logit curve requires at least four calibration points, but for the other types of curves only two of them are needed.

Quantitative assay parameters: FSH

Standard parameters

Number of standards: 6

Concentrations

1) 0

2) 5

3) 10

4) 25

5) 50

6) 100

7) 0

8) 0

9) 0

10) 0

Kind of curve

Point to Point

Standard values

Male: 0

Female: 0

Unit of: IU/l

OK

Cancel

Help...

**CURVE:
Point to point**

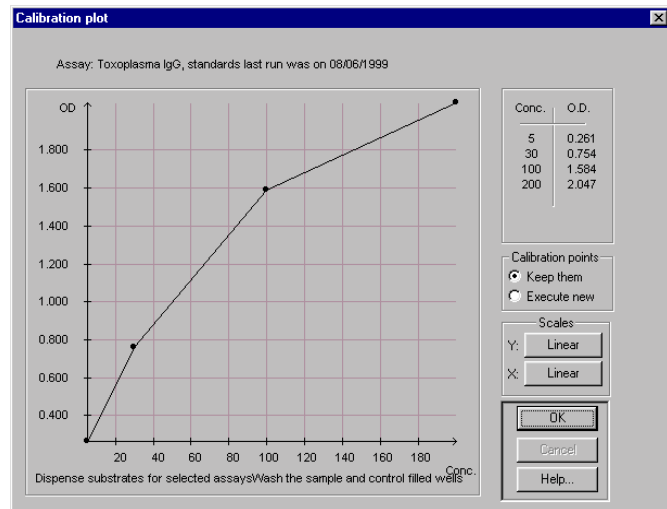

**CURVE:
Linear regression**

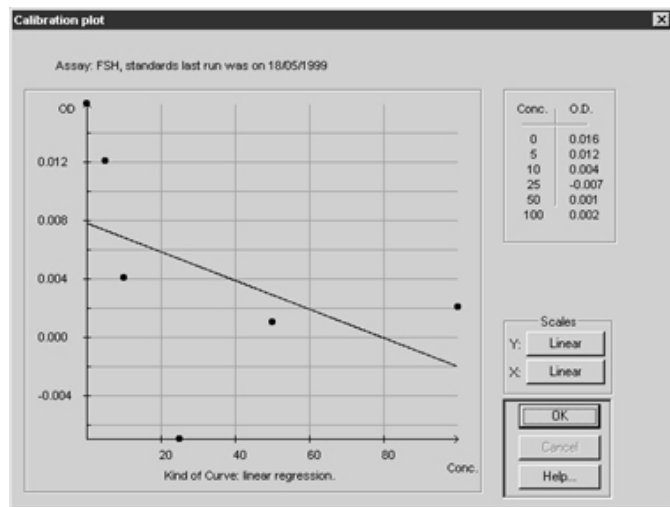

**CURVE:
Log-logit (polynomial regression)**

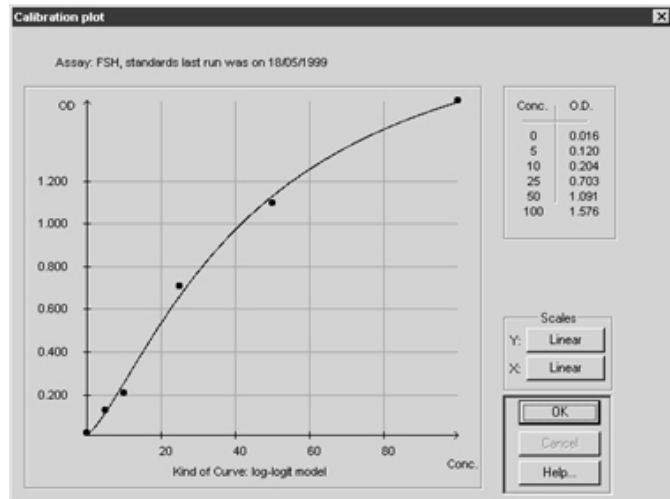

The *Qualitative parameters* button shows the parameter setting window for this type of analysis.

From this window, for each method, it is possible to:

- insert the control names used by the method (Names), selecting them from the present ones in the list or writing them directly into the box.
- set the acceptance control condition (Control check), up to a maximum of four conditions.
- Enable the predilution of controls

- set the positivity condition. That means that it has to be set if the sample absorbance has to be higher or lower than the one of the Cut-off, to consider the sample positive (see note 1);
- set the cut-off equivocal zone;
- set the cut-off absorbance calculation value

*Note 1: The **Cut-off** is a threshold value of absorbance, to be determined for every assay, on the basis of the calculation criteria specified by the manufacturer of the assay reagent kit.*

Cut-off calculation

To calculate the Cut-off the program uses the following general parametric equation :

$$OD_{\text{Cut-off}} = (a \times C_1) + (b \times C_2) + c$$

Where **a**, **b**, **c** are three constants and **C₁**, **C₂** the OD values of the measured controls in positions C1 and C2.

Note 2: If the controls in positions C1 and C2 have been measured more than one time, the instrument automatically uses their mean values.

For every assay this formula has to be adapted attributing specific values to the three constant factors, interpreting the calculation criteria specified by the manufacturer of the assay reagent kit. (See Examples given in Table 5.5)

Interpretation of Results

Once the Cut-off has been determined, the program uses this value, for the positive/negative evaluation of each sample processed with that assay method.

If the "positive condition" corresponds to "Sample OD > Cut-off OD":

$$OD_{\text{sample}} > OD_{\text{Cut-off}} + x \% \quad \text{--> positive}$$

$$OD_{\text{sample}} < OD_{\text{Cut-off}} - x \% \quad \text{--> negative}$$

If the "positive condition" corresponds to "Sample OD < Cut-off OD":

$$OD_{\text{sample}} < OD_{\text{Cut-off}} - x \% \quad \text{--> positive}$$

$$OD_{\text{sample}} > OD_{\text{Cut-off}} + x \% \quad \text{--> negative}$$

Note 3: x % represents the equivocal zone

Cut-off calculation Examples

Example 1

$$\text{cut-off} = (\text{NC} + \text{PC}) / 2 \quad (1)$$

Having 3 controls (NC, PC, HC), supposing to calculate the Cut-off according to the optical density values average of the negative and positive controls:

[NC = negative control]
[PC = positive control]
[HC = high positive control]

Considering that formula (1) can be written as following:

$$\text{cut-off} = \text{NC} / 2 + \text{PC} / 2$$

comparing this formula with the general one provided by the instrument:

$$\text{cut-off} = a \times C1 + b \times C2 + c \quad (2)$$

it is possible to calculate the cut-off value as required by the method, assigning to the coefficients "a", "b" and "c" the following values :

$$a = 0,5 \quad b = 0,5 \quad c = 0;$$

The negative control has to be positioned in C1 position and the positive control in C2 position.

The high positive control may be positioned in any other position.

Example 2

$$\text{cut-off} = \text{NC} + K \times \text{PC} \quad (K = \text{Factor})$$

In this case the instrument calculates the cut-off as indicated by the method, using the formula (2) and by choosing the following values for the coefficients:

$$a = 1 \quad b = K \quad c = 0;$$

The negative control has to be positioned in C1 position and the positive control in C2 position.

Example 3

$$\text{cut-off} = \text{PC} \times K \quad (K = \text{Factor})$$

In this case the instrument calculates the cut-off according to the method requirements using the formula (2) and by choosing the following values for the coefficients:

$$a = K \quad b = 0 \quad c = 0;$$

The positive control has to be positioned in C1 position .

Example 4

$$\text{cut-off} = K \quad (K = \text{constant})$$

In this case the instrument calculates the cut-off according to the method requirements, using the formula (2) and by choosing the following values for the coefficients:

$$a = 0 \quad b = 0 \quad c = K.$$

Example 5

The cut-off is available

[NC = negative control]
[CO = Cut-off]
[PC = positive control]

Having 3 controls (NC, CO, PC), supposing to put the Cut-off in C2 position, choose the following values for the coefficients:

$$a = 0 \quad b = 1 \quad c = 0.$$

5.5.1 Working Parameters

Predilution

The screenshot shows a software window titled 'Predilution' with a menu bar containing 'Sample', 'Conjugate', 'Substrate A-B', 'Stop', and 'Read'. The main area is for 'DHEAS' and contains the following controls:

- Name:** A text input field containing 'DHEAS'.
- Syringe speeds (Hz):**
 - Dispensing:** A numeric input field with '3000' and a blue highlight.
 - Aspiration:** A numeric input field with '1000'.
 - Sample Aspiration:** A numeric input field with '500'.
- Volumes (µl):**
 - Washing:** A numeric input field with '1000'.
 - Cycles:** A numeric input field with '2' and up/down arrow buttons.
 - Air bubble:** A numeric input field with '12'.
 - Dead Vol.:** A numeric input field with '10000'.

Predilution	
<i>Dispensing</i>	Syringe speed for dispensation of the diluent/sample
<i>Aspirating</i>	Syringe speed for diluent aspiration
<i>Sample Aspiration</i>	Syringe speed for sample aspiration
<i>Washing</i>	Volume of liquid for the cycle washing
<i>Cycles</i>	Number of wash cycles between samples
<i>Air bubble</i>	Volume of air bubble
<i>Single</i>	Execution time for a single dispensation of sample (*)
<i>Dead Vol.</i>	Remaining volume inside the dilution bottles

Sample

Predilution	Sample	Conjugate	Substrate A-B	Stop	Read
Name E2					
Syringe speeds (Hz)		Volumes (µl)		Execution time (s)	
Dispensing 3000		Washing 1000		Single 23	
Aspiration 500		Cycles 2		Duplicate 24	
Duplicate sample disp. mode		Air bubble 12		Dispensing mode	
Off 1 well at time		Dead Control Vol 200		<input type="checkbox"/> Dispense diluent in the blank well	
On 2 wells at time		Dead Standard Vol 200		<input type="checkbox"/> Dispense sample together with the conjugate	

Sample	
<i>Dispensing</i>	Syringe speed for serum dispensation
<i>Aspirating</i>	Syringe speed for serum aspiration
<i>Washing</i>	Volume of liquid for the cycle washing
<i>Cycles</i>	Number of wash cycles between samples
<i>Air bubble</i>	Volume of air bubble
<i>Duplicate Sample disp. mode</i>	Dispensation mode for the sample (1 well at time)
	Dispensation mode for the sample (2 well at time)
<i>Single</i>	Execution time for a single dispensation of sample (*)
<i>Duplicate</i>	Execution time for a double dispensation of sample (*)
<i>Dispensing Mode</i>	The diluent will dispense in the blank well
	The sample will be dispense together with conjugate, the first incubation time will be automatically zero
<i>Dead Control Vol.</i>	Remaining volume inside the control vials
<i>Dead Standard Vol.</i>	Remaining volume inside the calibrator vials

(*)*Note: the parameters can alter the activity program bar; the default value are estimated on the base at the machine's overage performance. More accurate value can be set-up checking the real execution time.*

Conjugate

The screenshot shows the 'Conjugate' tab of a software interface. At the top, there are navigation tabs: 'Predilution', 'Sample', 'Conjugate', 'Substrate A-B', 'Stop', and 'Read'. The 'Conjugate' tab is active. Below the tabs, there are several input fields and checkboxes:

- Name:** A text box containing 'Ez'.
- Dispense conjugate in the blank well:** A checkbox that is currently unchecked.
- Syringe speeds (Hz):** A section with two input boxes: 'Dispensing' (value: 3000) and 'Aspiration' (value: 1000).
- Volumes (µl):** A section with three input boxes: 'Washing' (value: 1000), 'Air bubble' (value: 12), and 'Dead Vol.' (value: 2000). The 'Washing' box has a small spinner control to its right.
- Dispensation mode:** A section with four checkboxes: '1 well at time' (unchecked), '2 wells at time' (unchecked), '4 wells at time' (unchecked), and '8 wells at time' (checked).
- Execution time (s):** An input box with the value '34'.

	Conjugate
<i>Dispensing</i>	Syringe speed for conjugate dispensation
<i>Aspirating</i>	Syringe speed for conjugate aspiration
<i>Washing</i>	Volume of liquid for the cycle washing and number of wash cycles between samples
<i>Air bubble</i>	Volume of air bubble
<i>Dispensation Mode</i>	Dispensation mode for the conjugate (1 well at time)
	Dispensation mode for the conjugate (2 well at time)
	Dispensation mode for the conjugate (4 well at time)
	Dispensation mode for the conjugate (8 well at time)
<i>Execution Mode</i>	Execution time to dispensing a complete strip of conjugate (*)
<i>Dispense Conjugate in the blank well</i>	If it is checked the conjugate will be dispense in the blank well
<i>Dead Volume</i>	Remaining volume inside the conjugate bottles

()Note: the parameters can alter the activity program bar; the default value are estimated on the base at the machine's overage performance. More accurate value can be set-up checking the real execution time.*

Substrate

Predilution	Sample	Conjugate	Substrate A-B	Stop	Read
-------------	--------	-----------	---------------	------	------

Name
EZ

<p>Syringe speeds (Hz)</p> <p>Dispensing 3000</p> <p>Aspiration 1000</p>	<p>Volumes (µl)</p> <p>Washing 1000</p> <p>Air bubble 12</p> <p>Dead Vol. 2000</p>	<p>Cycles 1</p> <p>Dispensation mode</p> <p><input type="checkbox"/> 1 well at time</p> <p><input type="checkbox"/> 2 wells at time</p> <p><input type="checkbox"/> 4 wells at time</p> <p><input checked="" type="checkbox"/> 8 wells at time</p> <p>Execution time (s) 34</p>
--	--	---

	Substrate A-B
<i>Dispensing</i>	Syringe speed for substrate dispensation
<i>Aspiration</i>	Syringe speed for substrate aspiration
<i>Washing</i>	Volume of liquid for the cycle washing
<i>Cycles</i>	Number of wash cycles between samples
<i>Air bubble</i>	Volume of air bubble
<i>Dead Volume</i>	Remaining volume inside the substrate bottles
<i>Dispensation Mode</i>	Dispensation mode for the substrate (1 well at time)
	Dispensation mode for the substrate (2 well at time)
	Dispensation mode for the substrate (4 well at time)
	Dispensation mode for the substrate (8 well at time)
<i>Execution Time</i>	Execution time to dispensing a complete strip of substrate (*)

()Note: the parameters can alter the activity program bar; the default value are estimated on the base at the machine's overage performance. More accurate value can be set-up checking the real execution time.*

Stop

Predilution | Sample | Conjugate | Substrate A-B | **Stop** | Read

Name: E2

Syringe speeds (Hz):
 Dispensing: 3000
 Aspiration: 1000

Volumes (µl):
 Washing: 1000
 Cycles: 1
 Air bubble: 12
 Dead Vol.: 2000

Dispensation mode:
 1 well at time
 2 wells at time
 4 wells at time
 8 wells at time

Execution time (s): 32

	Stop
<i>Dispensing</i>	Syringe speed for stop solution dispensation
<i>Aspiration</i>	Syringe speed for stop solution aspiration
<i>Washing</i>	Volume of liquid for the cycle washing
<i>Cycles</i>	Number of wash cycles between samples
<i>Air bubble</i>	Volume of air bubble
<i>Dead Volume</i>	Remaining volume inside the stop solution bottles.
<i>Dispensation Mode</i>	Dispensation mode for the stop solution (1 well at time)
	Dispensation mode for the stop solution (2 well at time)
	Dispensation mode for the stop solution (4 well at time)
	Dispensation mode for the stop solution (8 well at time)
<i>Execution Time</i>	Execution time to dispensing a complete strip of stop solution (*)

Read

Predilution | Sample | Conjugate | Substrate A-B | Stop | Read

Name
E2

Read
Reading delay time
60

	Read
<i>Reading delay time</i>	Waiting time of the reader to perform the absorbance 's reader

5.6 Rack Arrangements

ELISYS 2 has the capability to work with racks of different type from the standard.

These racks called “universal “ are capable to hold bottles of different size. They are of two types:

- Universal Reagent rack (Fig. 1)
- Universal Common rack (Fig. 2)

The universal reagent rack is equipped with removable rings to better fit the smaller bottles size.

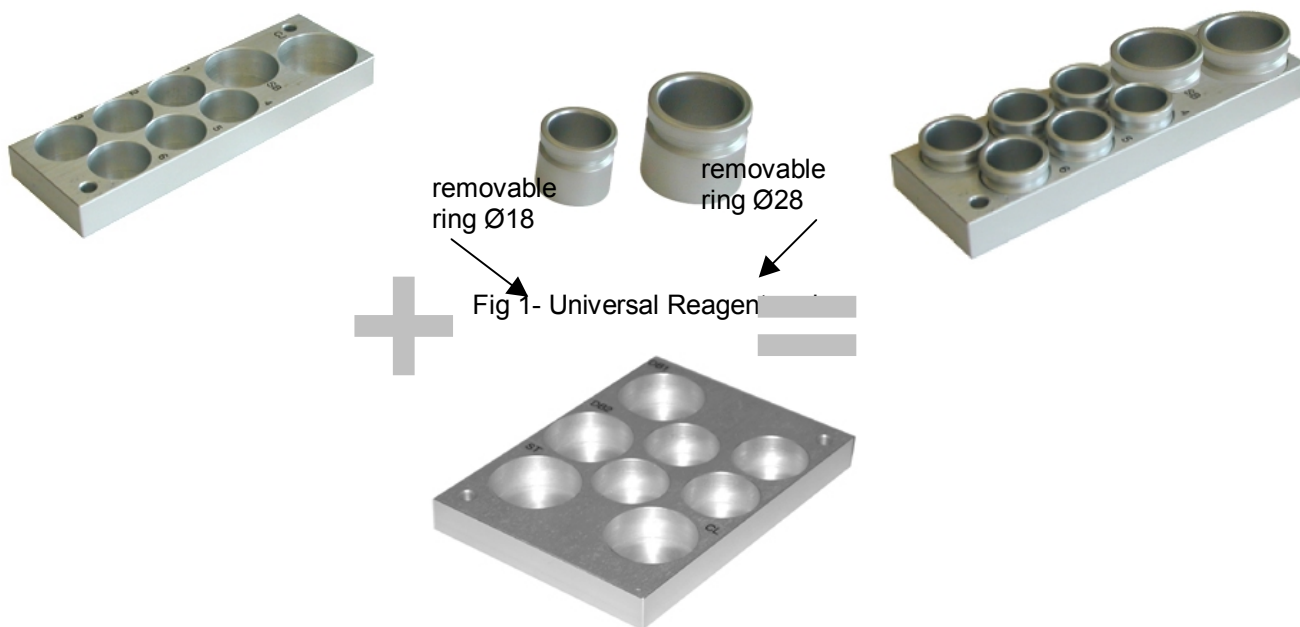

Fig 2 - Universal Common rack

5.6.1 Disposition on the Working Area- Standard Racks

The disposition of standard racks on the working area is shown in Fig.3. the standard common rack is placed on the left side, close to the sample rack. The standard reagent racks (up to 8 max), are placed in the following positions: from position 1 to position 8.

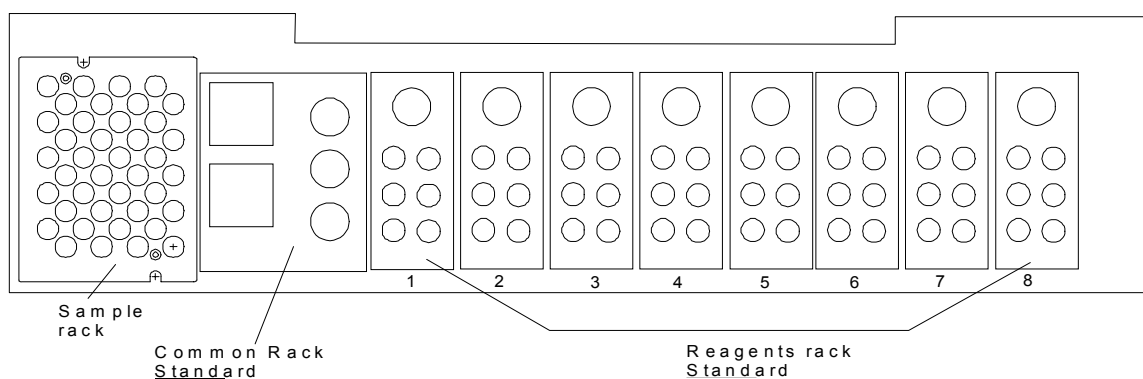

Fig.3

5.6.2 Disposition on the Working Area -Universal Racks

To introduce the universal rack on the working area, the following criteria are to followed (see Fig. 4):

- The universal common reagent has to be placed always on the right side of the working area to cover position 7 and 8.
- The universal reagent racks are to be placed on the following positions from 6 up to 1 (a maximum number of 6 universal reagent racks can be positioned)

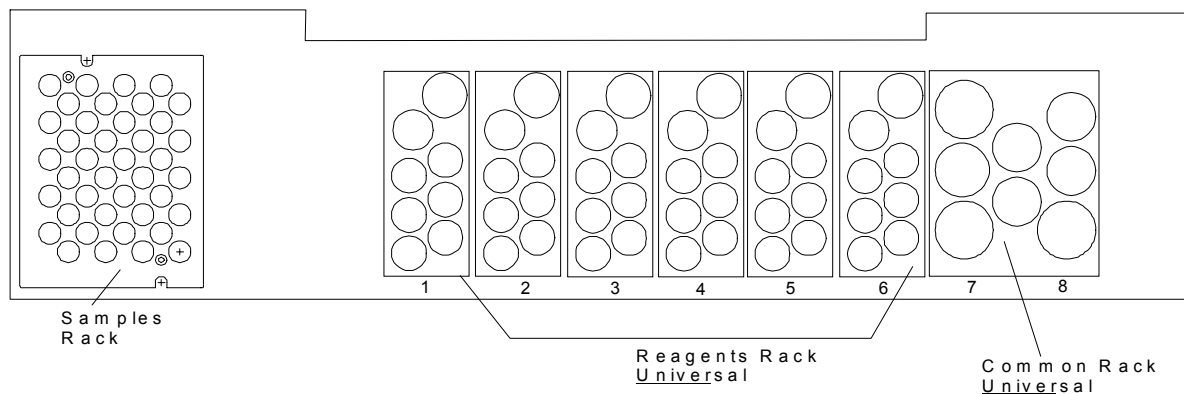

Fig. 4

5.6.3 Disposition on the Working Area - Mixed Arrangement

A mixed arrangement can only be made when using Rack 6 or 7 together with the common rack universal (pos. 7+8)

It is possible to have a mixed configuration made up with standard and universal racks.

In this case as shown in Fig 5, the common universal rack is placed on the right side, the standard common rack is placed on the left side, between them a combination of standard and universal reagent racks can be positioned according to the needs.

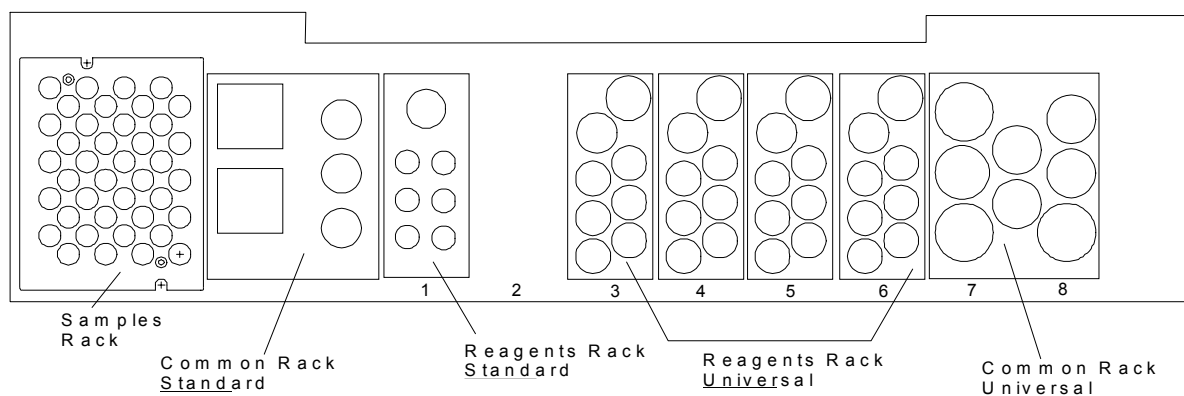

Fig.5

Note 1: The position of the two common racks is fixed and not interchangeable(universal common racks always on the right, standard common rack always on the left).

Note 2: The maximum number of standard reagent racks is 8, if there are no universal racks.

Note 3: The maximum number of universal reagent racks is 6, if there are no standard racks (position 7 and 8 are busy with the universal common racks).

5.6.4 Working with two Substrates

In order to direct the instrument to handle two substrates A + B group parameter 131 must be assigned in the assay parameter settings. This option only works if the ratio between Substrate A and B consists of equal portions I.E 50 µL A + 50 µL B.

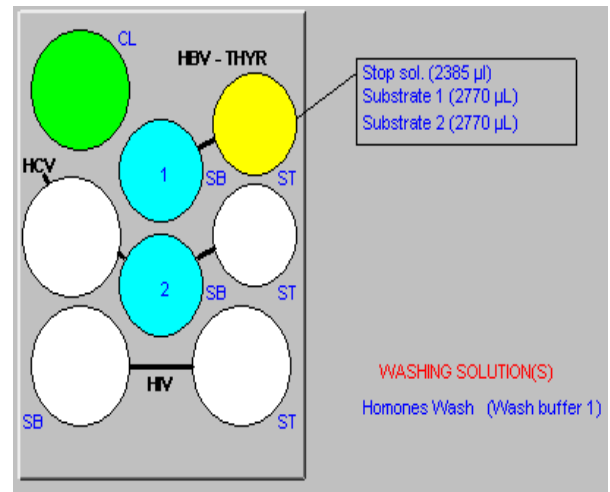
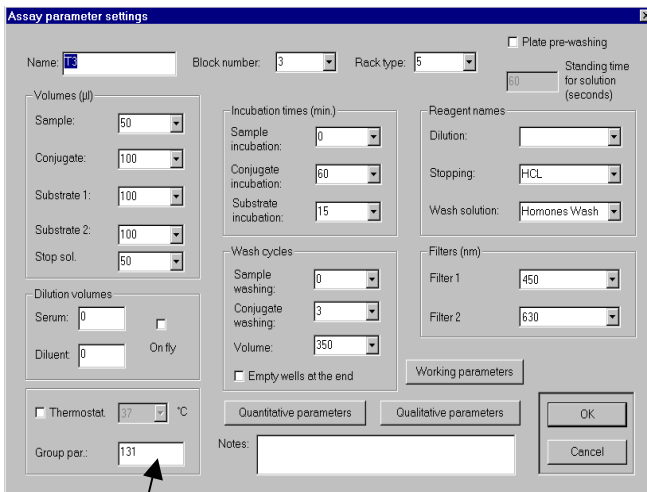

5.6.5. Definitions for BLOCK-, RACK TYPE- AND GROUP PARAMETER

BLOCK PARAMETER

The block parameter identifies the assays that can be processed in the same run.

Assays that cannot be processed in the same run are:

- Assays with different conjugate incubation time or different substrate incubation time.
- Assays with different incubation temperature.
- Assays with other different characteristics, like for example different common reagent trays.

RACK TYPE PARAMETER

The rack type parameter identifies the different types of racks.

GROUP PARAMETER

Refer to appendix E

5.7. Settings

This menu allows to set the analysis laboratory name and the name of the Doctor responsible for the analysis which will appear on the program's printouts (reports and summary prints of the working session).

The settings of the communication between computer and instrument can also be modified, but the use of this option is only recommended to expert users. By means of the **Password** menu you can introduce a new password.

5.7.1 Break on error

In case of a low or missing reagent/sample, the instrument switches to a pause mode. The user can decide to refill the missing component or direct the Elisys 2 to continue.

This option must be activated in AP2.ini file.

1. Open the ini.file with wordpad or notepad.
2. Change the following command line.

BreakOnError=0

In case of a low or missing reagent/sample the ELISYS2 continues pipetting. The missing components are logged and can be identified later in Labfile.

BreakOnError=1

In case of a low or missing reagent/sample the ELISYS2 stops and the user can decide to refill or direct the ELISYS to continue. The missing components are logged and can be identified later in the Labfile.

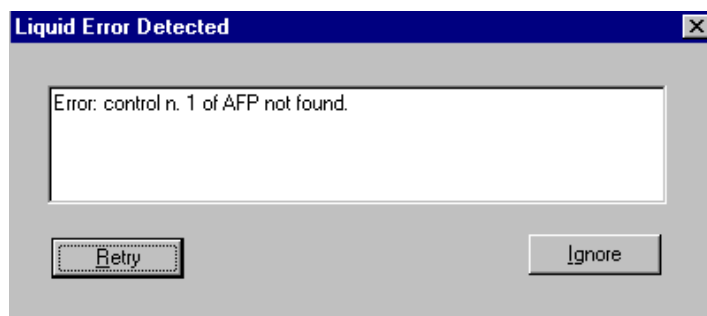

5.7.2 External Incubation

Using the external incubation function allows to place the plates for incubation outside of the system, i.e. on a shaker. During the external incubation period the ELISYS 2 can be used to perform other tests i.e. washing another plate or dispense the samples.

The inserted tests can only be executed in single step operation.

If the performance time for the selected step is longer than the remaining incubation time this step cannot be started.

When the incubation time has finished the system informs the user to take the plates back to the system to continue with the assay processing.

This function gives the ELISYS 2 a greater flexibility and contributes to increase the capacity of the system.

To enable the external incubation two set-ups have to be done:

1. In the settings menu the ext. incubation option has to be marked.
2. In the assay parameter settings of the concerned test the thermostat checkbox has to be marked

When these condition are fulfilled the software comes up with this message. Answering yes gives the user the possibility to insert another test.

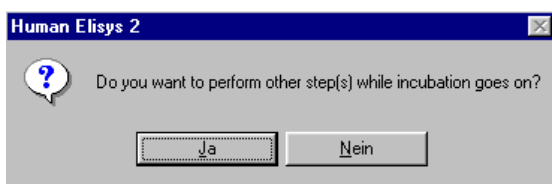

After choosing an assay the software requests to remove the plate from the system and put the new one to the work position.

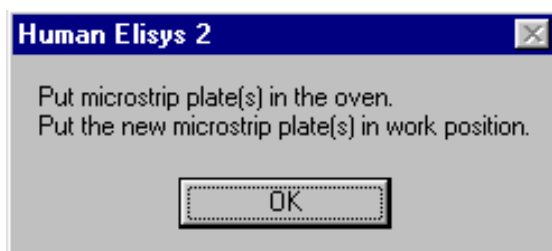

During processing the new assay the remaining time from the external located test is displayed.

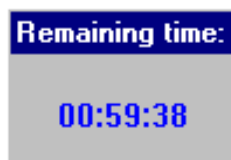

When the incubation time is over the software prompt to bring the plate back to the system in order to continue with the test procedure.

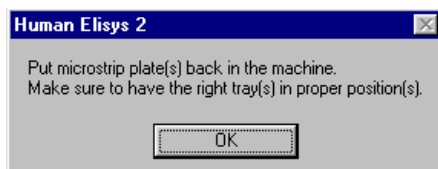

5.7.3 Simulation mode

The demo mode allows a complete run to be performed in a dummy mode without the need to connect an instrument.

Among other things it can be used to demonstrate the software, including the data reduction, even without an instrument.

In order to activate the demo mode open in the menu:

1. Settings
2. Serial port

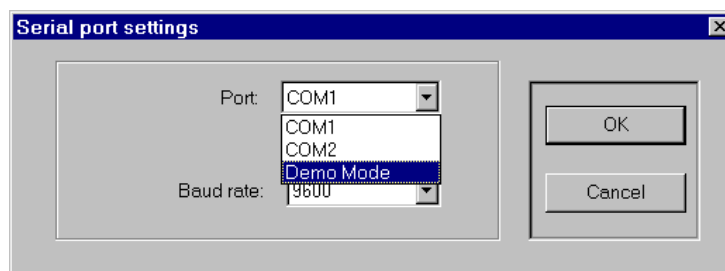

5.7.4 92 Positions for predilution

A new segment for the predilution have been designed. The new segment has enough space for 92 prediluted samples. This rack is not part of the standard equipment. It can be ordered with cat. No. 173017104. Regardless of the serial number each ELISYS 2 can be updated.

The following steps are required to enable this rack in the software

1. Open the ini.file with wordpad or notepad.
2. Change the following command line.

PredilutionRack=0 (Standard 20 position segments)

PredilutionRack=2 (92 Position Rack)

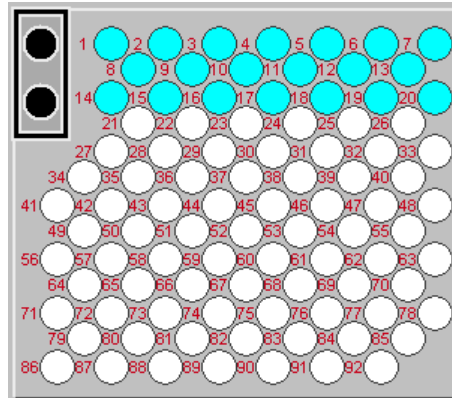

5.7.5 Substrate incubation at 37°

Some ELISA tests also require the substrate incubation time at 37°. The ELISYS 2 software also supports this kind of ELISA test.

The following steps are required to enable this feature :

1. Open the ini.file with wordpad or notepad.
2. Change the following command line.

ThirdThermoIncubation=0 (the substrate incubation takes place at room temperature)

ThirdThermoIncubation=1 (the sample and conjugate incubation temperature is maintained also for the substrate incubation time)

5.7.6 Dilution and wash buffer names

A new database for dilution and wash buffer names was introduced. It is possible to predefine up to 5 different names for each liquid. The predefinitions appears in the reagent name compartment in the assay parameter settings section.

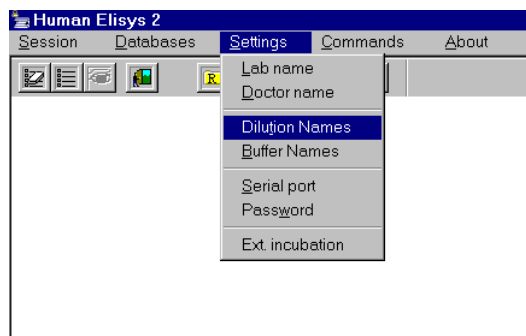

5.8 Commands

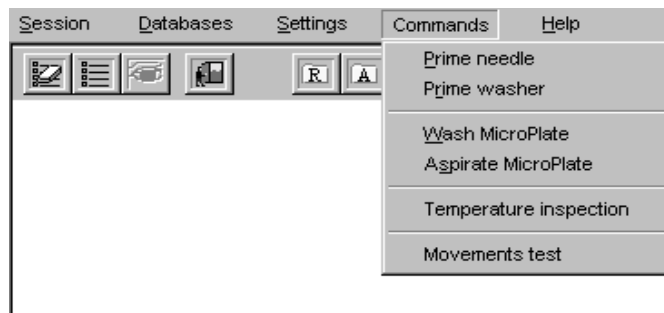

This menu contains a series of commands for simple operations and diagnostic instruments to check the function of the instrument.

The first set of commands contains: Prime needle, Prime washer, Wash Microplate and Aspirate Microplate. **The use of the first two commands is highly recommended before starting each working session to prime the instrument with the working solutions. Its use is also recommended at the end of each working session, to change the working liquids with distilled water, to clean the instrument and to prevent the inside of the machine from the forming of solid residuals.**

The second set of commands can be selected to use the machine as a simple plate washer. It is possible to set the number of strips on which commands can be entered.

The third set of commands contains: Temperature test and Movement test. The first command allows to control the functioning of the instrument's thermo-regulation setting a temperature threshold to be reached. The second one executes the motor test of each machine, telling the user about possible bad function.

SECTION 6 MAINTENANCE



Only qualified personnel is entitled to carry out maintenance (see Section 1 of this manual). Carrying out the maintenance operations, follow the general warnings as described in Section 1 of this manual as well as the below safety rules.



The operating instrument makes use of chemical reagents and other dangerous (corrosive, irritant and harmful) **CHEMICAL SUBSTANCES** which can cause material and personal damages. When this label is found, pay attention to the producer recommendations



The operating instrument handles samples which can be infected (urine and human serum). In this condition **INFECTIONS** or **CONTAMINATION** might occur. Pay attention to the general safety warnings when in presence of such biological substances. Use protective clothes, gloves and glasses.

Prior to any repair intervention and/or to transportation of the instrument, disinfect the instrument following the applicable instructions !
(See APPENDIX A)

6.1. Checks and Preventive Maintenance

See the below table for the recommended preventive maintenance operations:

Operation	Period
Cleaning the instruments parts	Daily and/or at the end of each work session
Cleaning the needle outside (Alcohol soaked cloth)	Begin and at the end of each work session
Needle prime with distilled water	Begin and at the end of each work session
Washer prime with distilled water	Begin and at the end of each work session
Tubing, diluter and manifold decontamination (see: page 47)	If necessary
Replace syringe tip (see: page 47)	Monthly
General inspection and checks	At interval of 6 months
Using cleaning solution (Recommendation Alcohol)	Every run

As the instrument could be used in different conditions and terms, maintenance has to be done according to the use of the instrument, the period indicated on the above table has to be taken as an average. After an inactivity long period, a general maintenance is required before using the instrument again.

Some parts of the instrument (although not visibly damaged) have to be replaced by a qualified “service level” technician before the use according to the below table:

2 nd level maintenance operations (service level)	Period
Replacing internal connecting tubing	12 months
Replacing peristaltic pump tubing	3 months
Replacing Lamps	12 months (that is 500 hours)
Cleaning the optical group lenses	9 months
Internal cleaning of the washer group	6 months

6.2 Cleaning the Instrument's Parts



Warning: cleaning the instrument, do not use alcohol or similar solutions! A use of 0.5 sodium hypochlorite solution is recommended.



When cleaning don't let electric parts (connectors, etc.) get wet, if necessary, before turning on the instrument, dry them out

After each work session, clean/disinfect the instrument carefully:

- Use a water soaked cloth (or light detergent) to clean the instrument external parts
- To clean the wells use a water soaked cotton cloth then dry it; make sure not to leave any particle inside.

6.3 Tubing, Diluter and Manifold Decontamination

- To perform a decontamination fill bottle T1 and T3 with the decontamination solution. For decontamination can be used i.e. NaOH 1Mol. Prime the needle and the washer unit At least 5 times with the decon solution.

When the decontamination process has finished, it is very important to run multiple wash cycles for the needle and for the washer unit with distilled water.

The room and table where the instrument is placed have to be always clean; remove any dirt.

Note: When the instrument, for cleaning or disinfecting purpose, requires a washing cycle :

- for manifold cleaning, bottle T1 has to be substituted with an equivalent bottle containing distilled water or decontaminating solution (see Sect. 4.4).
- for needle internal and external cleaning, bottle T3, normally containing distilled water, has to be substituted with an equivalent bottle containing decontaminating solution (see Sect. 4.4).

6.4 General Inspections and Checks

It is advisable to check periodically all the instrument parts.

6.5 Replace the Syringe Tip

The instrument can perform precision dispensation with up to 10 µl due to the 1 ml syringe located on the diluter. The syringe tip status has always to be good, in that it can be worn out by the continuous work (we suggest replacing the tip every months). To replace the tip, operate as follows.

1. Open the SIM program. Type the letters "TM". Press "ENTER". Press F9
2. Enter the command "A" and "1000". The syringe moves down until the end.
3. Turn the syringe anticlockwise until the glasbody free to move up and down.
4. Remove the guidance block (see picture) with a screwdriver.
5. Pull the plunger out of the glasbody
6. Replace the tip
7. Dissemble the hole unit.
8. Leave the sim program.
9. Prime the needle until the tubing system is free of air bubbles.

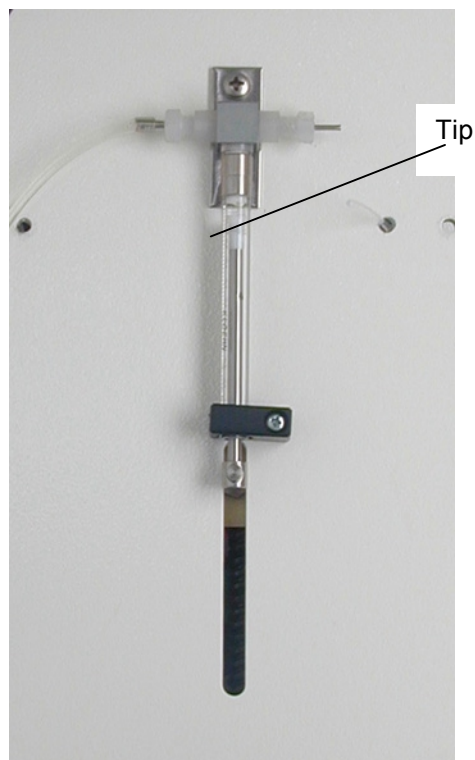

SECTION 7

PUTTING THE INSTRUMENT OUT OF SERVICE

7.1. General Warnings



The instrument has been used with samples potentially infected (urine, human sera etc.) that could have been caused **INFECTED CONTAMINATIONS**. General safety warnings about biological substances potentially infected have to be observed.

Before putting the instrument out of service, **IT HAS TO BE DISINFECTED!** (see APPENDIX A)

Before transportation or storage of the instrument, draw up the **DECONTAMINATION DECLARATION** dated and signed by a qualified person.

7.2. Put the Instrument out of Service

At the end of the instrument operating life, dispose of it taking in account the safety for people and environment.

- Unplug the instrument and the PC.
- Disinfect and clean carefully the instrument according to the given instructions (see Section 6 and Appendix A).
- Disconnect the inlet /outlet tubing as well as the level sensors; remove the plastic tanks and clean/disinfect them following the above mentioned instructions .



if the instrument has to be transported or stored, enclose the **Decontamination Declaration**, dated and signed by a qualified operator.

7.2.1. Momentary Stocking

Deactivate the instrument and label it with warning signals of "OUT OF SERVICE "

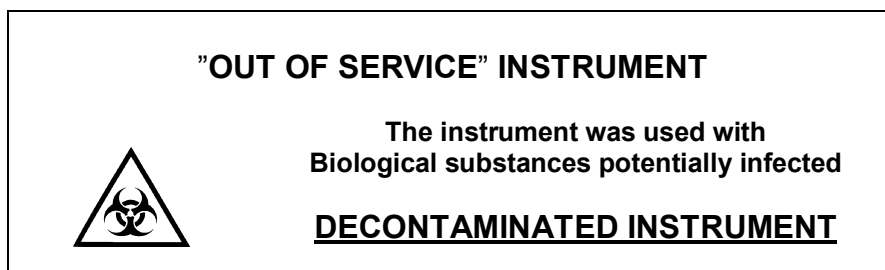

7.3. Instrument Transport and Handling

The instrument is packed with a plywood box, which can be easily moved by a lifting trolley.

Be careful when placing the instrument onto the work area.



The safety warnings and general rules have to be observed when moving or lifting the instrument.

INSTRUMENT WEIGHT \cong 80 Kg

PACKED INSTRUMENT WEIGHT \cong 100 Kg



When shipped or transported the instrument has to be provided with **DECONTAMINATION DECLARATION** (see Appendix A of this manual).

7.4. Instrument Storage

Before storing the instrument for a long time, pack it carefully as described above.

Relative humidity has to be less than 85% and temperature between -10°C and +60°C.



When stored the instrument has to be provided with **DECONTAMINATION DECLARATION** (see Appendix A of this manual).

APPENDIX A

INSTRUMENT DECONTAMINATION



The instrument involves the handling of samples which can be infected (urine and human serum) and positive controls. In this condition **INFECTIONS** or **CONTAMINATION** might occur. Every part and accessory of the instrument must be considered potentially infected.

Prior to any repair or maintenance intervention and before transporting the instrument a decontamination is necessary by using wide band disinfectant solutions !

Warning !

USE LABORATORY PROTECTIVE CLOTHES, DISPOSABLE GLOVES AND GLASSES WHILE DISINFECTING THE INSTRUMENT.

Fill in a decontamination declaration and enclose it with the instrument. If the declaration is missing, the customs officers or your service centre can refuse the instrument.

Decontamination Procedure

Use one of the following wide band disinfectant solutions:

- Aseptisol Manufacturer: Bode Chemie Amburg
- Germocid Plus Manufacturer: Germa S.p.a. Milano
- Lysetol Manufacturer: Schülke & Mayr Ges.m.b.H.



Use the solution only for the instrument surface.

1. Wear disposable gloves, protective glasses and suitable clothes.
2. Prepare an autoclave bag for the disposable items used for the decontamination and label the bag with an autoclave band mark.
3. Unplug the instrument in order to avoid explosions.
4. Remove all the accessories and disinfect the ones which have to be sent with the instrument.
5. Spray the disinfectant solution on the instrument surface. or use a cloth or paper soaked in a disinfectant solution.
6. Leave the solution on the instrument for 10 minutes and repeat the treatment from the preceding point.
7. Leave the solution on the instrument for 5 hours, clean the instrument surface by a light detergent or water to eliminate any dirt or disinfectant solution.
- 8 Carefully dry the instrument.
9. Put the instrument and its accessories into their original box.
10. Wash and disinfect the hands by using a light detergent.
11. Fill in a Decontamination Declaration and enclose it with the instrument.

Decontamination Declaration

The Decontamination declaration as shown below, has to be filled in and enclosed with the instrument before shipping it for a maintenance service.

The declaration Has to be stuck on the instrument package.

<u>DECONTAMINATION DECLARATION</u>	
Instrument:	_____
Model:	_____
S/N :	_____
We declare that :	
? the instrument and its accessories never came in touch with dangerous biological substances,	
? the instrument and its accessories have been decontaminated to eliminate every biological substance which could be dangerous for personnel.	
User/Client name:	_____
Address:	_____
Country:	_____
Responsible name:	_____
Date _____	<i>Signature and Stamp</i>

APPENDIX B

Spare Parts – Consumables – Accessory Parts

A separate Spare Parts List is available in the Service Manual.

HUMAN Cat.-NO.	Description
17301/45	Predilution segment (re-usable)
17301/46	Interferential filter 405nm
17301/47	Interferential filter 492nm
17301/52	Sample rack 60 positions
17301/150	Sample rack 80 positions
17301/53	Sample rack 40 positions
17301/54	Reagent rack for HBV
17301/55	Reagent rack for HCV
17301/56	Reagent rack for HIV1+2
17301/57	Reagent rack for Thyroids
17301/58	Reagent rack Infectious Diseases
17301/93	Reagent rack for Steroids
17301/89	Reagent rack free format
17301/59	Common rack Infectious Diseases
17301/60	Common rack Hormones,HIV,HCV,HBV
17301/90	Common rack Universal
17301/91	Adapter Ring 18,5 mm
17301/92	Adapter Ring 28 mm
17301/35	Syringe tip
17301/70	Software Set CD
17301/104	Fast Washing System
17301/103	92 Position Predilution Plate
17301/110	Reader Protection Plate
17300/1	User Manual
17300/2	Service Manual
17300/6	Short Description
17300/7	Rack Description

APPENDIX C

ELISYS 2 Rack Description

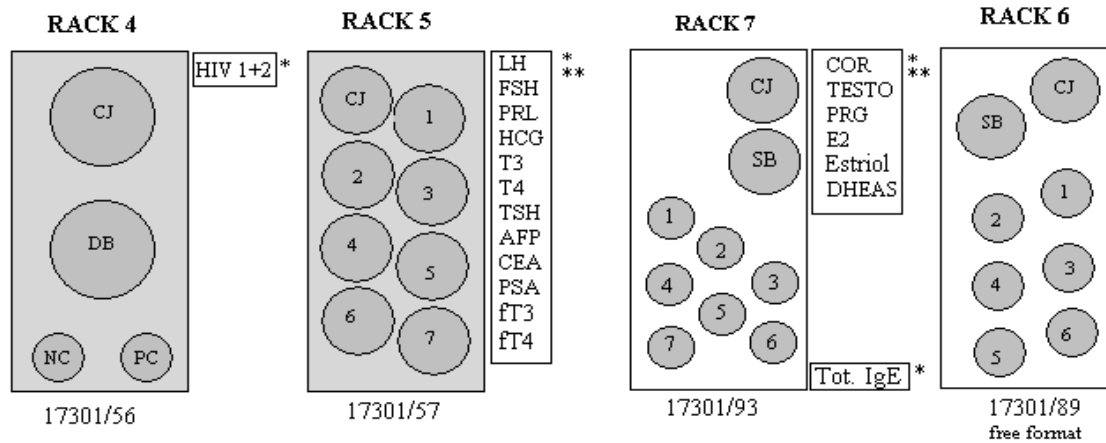
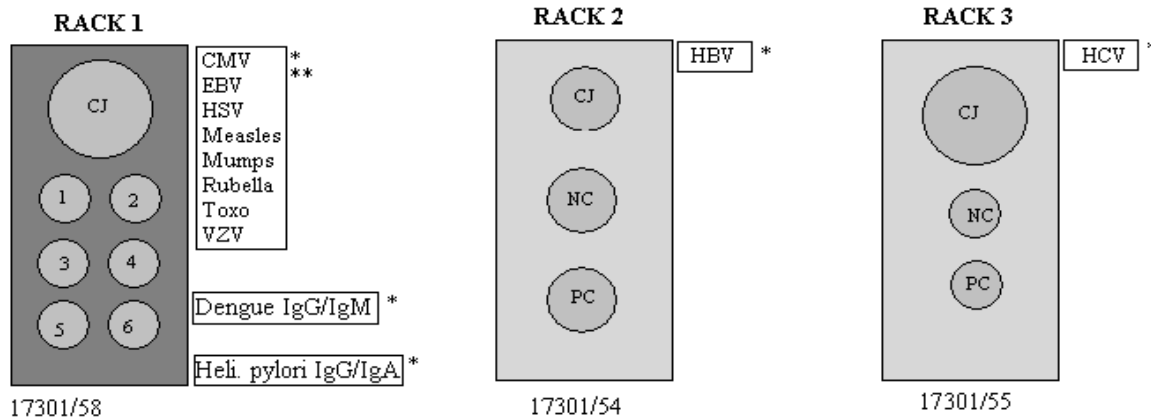

**UNIVERSAL COMMON RACK
INFECTIOUS DISEASES**
17301/59

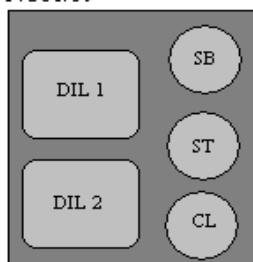

used with: **RACK 1**

**HORMONES, HIV
HCV AND HBV**
17301/60

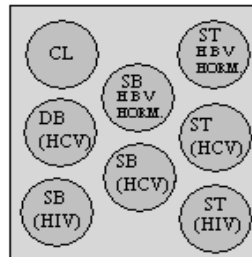

used with: **RACK 2
RACK 3
RACK 4
RACK 5**

**COMMON RACK
UNIVERSAL**
17301/90

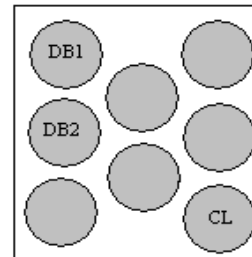

used with: **RACK 6
RACK 7
free format**

The Racks are optimized for Human Tests. Rack 6 is a free format Rack and has removable rings to fit different bottle sizes.

* HUMAN Methods

** Methods can be executed together (combined)within one session

APPENDIX D

Group – Rack-Block -Division

TEST	GROUP PAR.	RACK TYPE	BLOCK N.
CMV IgG / IgM	1	1	1
EBV IgG / IgM	1	1	1
HSV1 IgG	1	1	1
HSV2 IgG	1	1	1
HSV IgM	1	1	1
Measles-Virus IgG / IgM	1	1	1
Mumps-Virus IgG / IgM	1	1	1
Rubella IgG / IgM	1	1	1
Toxoplasma IgG / IgM	1	1	1
Varicella IgG / IgM	1	1	1
LH	3	5	3
FSH	3	5	3
Prolactin	3	5	3
hCG	3	5	3
T3	3	5	3
T4	3	5	3
TSH	3	5	3
AFP	3	5	3
CEA	3	5	3
PSA	3	5	3
Testosteron	20	7	3
Cortisol	20	7	3
Progesteron	20	7	3
E2	20	7	3
ESTRIOL	20	7	3
DHEAS	20	7	3
FT3	3	5	3
FT4	3	5	3
HbsAg	5	2	2
anti-HBs	5	2	2
anti-HbcAg	5	2	2
anti-HCV	4	3	3
HIV 1+2	2	4	5
Total – IgE	131	7	3
Helicobacter IgG / IgA	1	1	1
Dengue IgG / IgM	1	1	1

Note: Bordered methods can be combined within on session

APPENDIX E

Definitions for Groups

Group No.1

Used for :

CMV IgG, CMV IgM, EBV IgM, EBV IgG, HSV1 IgG, HSV2 IgG, HSV IgM, Measles IgG
Measles IgM, Mumps IgG, Mumps IgM, Rubella IgG, Rubella IgM, Toxo IgG, Toxo IgM, Varicella IgG
Varicella IgM, Helicobacter IgG / IgA, Dengue IgG / IgM

Predilu1.ap2: (dilution ratio 1:100)

- SV1000 syringe suck up speed; the sample dilution is carried out in two times, the dispensation speed is SV3000.

Sample1.ap2: (dispensation volume 100µl)

- SV500 syringe suck up speed; the controls, standards and samples dispensation is carried out in double mode with just one move, the dispensation speed is SV2500. The blank wells are left empty.

Conjuga1.ap2: (dispensation volume 100µl)

- The conjugate dispensation is not carried out onto the Blank wells;
- The syringe suck up speed is SV1000; the Conjugate dispensation is carried out with just one move, the suck up speed is SV3000.

Chromoge1.ap2: (dispensation volume 100µl)

- The syringe suck up speed is SV1000; the Chromogen dispensation is carried out with just one move, the dispensation speed is SV3000.

Stop1.ap2: (dispensation volume 100µl)

- The syringe suck up speed is SV1000; the Stop Solution dispensation is carried out with just one move, the dispensation speed is SV2500.

Group No.2

Used for :

HIV 1+2

Predilu2.ap2:

- The group does not involve the sample predilution.

Sample2.ap2: (dispenses 20µl of sample + 100µl of dilution)

- The samples and controls or standards dilution solution is dispensed into the blank well with just one move. The syringe suck up speed is SV500; the dispensation speed is SV3000.
- The controls and the standards are dispensed together with the dilution solution, the dispensed volumes are described in the assay set up window. If the dispensation is in double mode, it is carried out with two single moves. The sucking syringe speed is SV500; the dispensation speed is SV2500.

Conjuga2.ap2: (dispensation volume 100µl)

- Also the Conjugate dispensation into the blank wells is carried out.
- The syringe suck up speed is SV1000; the Conjugate dispensation is carried out with just one move, the dispensation speed is SV3000.

Chromoge2.ap2: (dispensation volume 100µl)

- The syringe suck up speed is SV1000; the Chromogen dispensation is carried out with just one move, the dispensation speed is SV3000.

Stop2.ap2: (dispensation volume 100µl)

- The syringe suck up speed is SV1000; the Stop Solution dispensation is carried out with just one move, the suck up speed is SV2500.

Group No.3

Used for :

LH, FSH, Prolaktin, hCG, T4, T3, TSH, AFP, CEA, PSA, fT3, fT4

Predilu3.ap2:

- This group does not involve the sample predilution.

Sample3.ap2: (dispensation volume from 25µl to 50µl)

- If the controls or standards and samples dispensation is in double mode, it is carried out with two single moves. The suck up syringe speed is SV250; the dispensation speed SV2500. The blank wells are left empty.

Conjuga3.ap2: (dispensation volume 100µl)

- The Conjugate dispensation on the blank wells is not carried out;
- The suck up syringe speed is SV1000; the Conjugate dispensation is carried out with just one move, the dispensation speed is SV3000.

Chromoge3.ap2: (dispensation volume 100µl)

- The syringe suck up speed is SV1000; the Chromogen dispensation is carried out with just one move, the dispensation speed is SV3000.

Stop2.ap2: (dispensation volume 50µl)

- The syringe suck up speed is SV1000; the Stop Solution dispensation is carried out with just one move, the dispensation speed is SV2500.

GROUP No.4

Used for :

Anti HCV

Predilu4.ap2: (dilution ratio 1:20)

- Suck up speed of the SV1000 syringe; the sample dilution is carried out in two times, the dispensation speed is SV3000.

Sample4.ap2: (dispensation volume 100µl)

- The controls or standards and samples are dispensed with just one move. The syringe suck up speed is SV500; the dispensation speed is SV3000. The blank wells are left empty.

Conjuga4.ap2: (dispensation volume 100µl)

- The Conjugate dispensation is not carried out onto the blank wells;
- The syringe suck up speed is SV1000; the Conjugate dispensation is carried out with just one move, the dispensation speed is SV3000.

Chromoge4.ap2: (dispensation volume 100µl)

- The syringe suck up speed is SV1000; the Chromogen dispensation is carried out with just one move. The dispensation speed is SV3000.

Stop4.ap2: (dispensation volume 100µl)

- The syringe suck up speed is SV1000; the Stop Solution dispensation is carried out with just one move, the dispensation speed is SV2500.

Group No.5

Used for:

HbsAg, Anti-HBs, anti HbcAG

Predilu5.ap2:

- This group does not involve the sample predilution.

Sample5.ap2: (dispensation volume 50µl + 50µl of Conjugate)

- If the controls or standards and samples dispensation is in double mode, it is carried out with two single movements. The sucking up syringe speed is SV250; the dispensation speed is SV2500. The blank wells are left empty.
- The Conjugate is immediately carried out: the Conjugate dispensation onto the blank wells is not carried out. The syringe suck up aspiration is SV1000; the Conjugate dispensation is carried out with just one move, the dispensation speed is SV3000.

Conjuga5.ap2:

- The file is empty (dispensation already carried out, immediately after the controls).

Chromoge5.ap2: (dispensation volume 100µl)

- The syringe suck up speed is SV1000; The Chromogen suck up is carried out with just one move. The dispensation speed is SV3000.

Stop5.ap2: (dispensation volume 100µl)

- The syringe suck up speed is SV1000; the Stop Solution dispensation is carried out with just one move, the dispensation speed is SV2500.

Group No.20

Used for :

Testosteron, Cortisol, Progesteron, E2, FE3, DHEAS

Predilu3.ap2:

- This group does not involve the sample predilution.

Sample3.ap2: (dispensation volume from 25µl to 50µl)

- If the controls or standards and samples dispensation is in double mode, it is carried out with two single moves. The suck up syringe speed is SV250; the dispensation speed SV2500. The blank wells are left empty.

Conjuga3.ap2: (dispensation volume 200µl)

- The Conjugate dispensation on the blank wells is not carried out;
- The suck up syringe speed is SV1000; the Conjugate dispensation is carried out with two moves, the dispensation speed is SV3000.

Chromoge3.ap2: (dispensation volume 100µl)

- The syringe suck up speed is SV1000; the Chromogen dispensation is carried out with two moves, the dispensation speed is SV3000.

Stop2.ap2: (dispensation volume 50µl)

- The syringe suck up speed is SV1000; the Stop Solution dispensation is carried out with just one move, the dispensation speed is SV2500.

Group No.131

Universal Group

APPENDIX F

On Line Module

The function of this interface is to allow the user to import a working list from a remote computer and to transform the related data into an exportable format.

The communication link between the host and the client's PC is established through the following files:

- INPUT: Text file that includes the work list with WLT extension
- OUTPUT: Text file that includes all session results with LAB extension

After importing the work list from the WLT file and carrying out the analysis session, the software automatically generates an output file with a LAB extension that contains all information about the session results.

DETAILED SPECIFICATION OF THE INPUT FILE (WLT)

Set up the input file as in the following format to make it understandable by the client p.c. :

<Assays>

[Progressive number];[Assay Name]

.

.. (max 8 elements)

..

<Samples>

[Patient progressive]; [Patient Code]; [Progressive number of the first Assay]; ... ;[Progressive number of the last Assay]

..

. (max 40-60 patients according to the selected sample tray)

Procedure

To import a work list, use the following procedure:

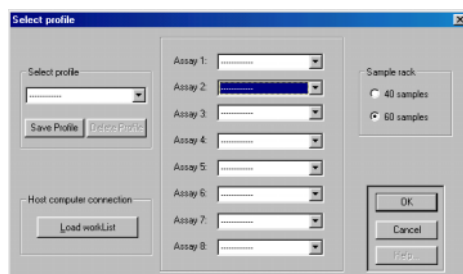

From "Select Profile" by pushing "Load work list" button, the following window will be shown:

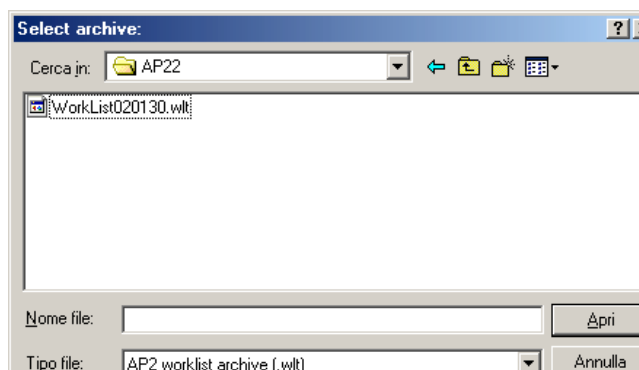

"Select Archive" allows the user to select the WLT file. Click button "Open" to accept.

If the file is correct, the assays specified in the file will be shown in the window "Select Profile". If the assay names do not match the ones defined in the local archive of the client's PC, an error message will be displayed.

Press "OK" in the "Select Profile" window to go to the sample selection window. During this phase the software checks the compatibility of the selected assays; an error message will be shown if in the same session something is not compatible.

The data coming from the WTL file are only accepted if they are compatibility to the selected sample tray. It is not allowed to load more samples than the ones accepted by the used tray.

Below is an example to clarify a WLT file structure along with the resulting LAB file.

Assuming to load a work list for 3 assays: Toxo_IgG, Rubella_IgM, CMV_IgM, the first assay will be carried out on all samples, the second assay will be carried out on the following samples: 1,3,4,6,7,9,10,12,13,15,16,18 and 19. The third assay will be carried out on the samples 1,4,7,10,13,16 and 19. The WLT will generate the following content:

```
<Assays>
1;Toxo_IgG
2;Rubella_IgM
3;CMV_IgM
<Patients>
1;PATIENT01;1;2;3
2;PATIENT02;1
3;PATIENT03;1;2
4;PATIENT04;1;2;3
5;PATIENT05;1
6;PATIENT06;1;2
7;PATIENT07;1;2;3
8;PATIENT08;1
9;PATIENT09;1;2
```

Once the session has been completed, a file with a LAB extension will be automatically generated. The file name will be composed of the execution date and the changing of the last 2 digits for the progressive number , e.g.: the first work session of February 14th 2002 will generate the file name 2002021400 LAB.

APPENDIX G

Operating Flow Diagramm

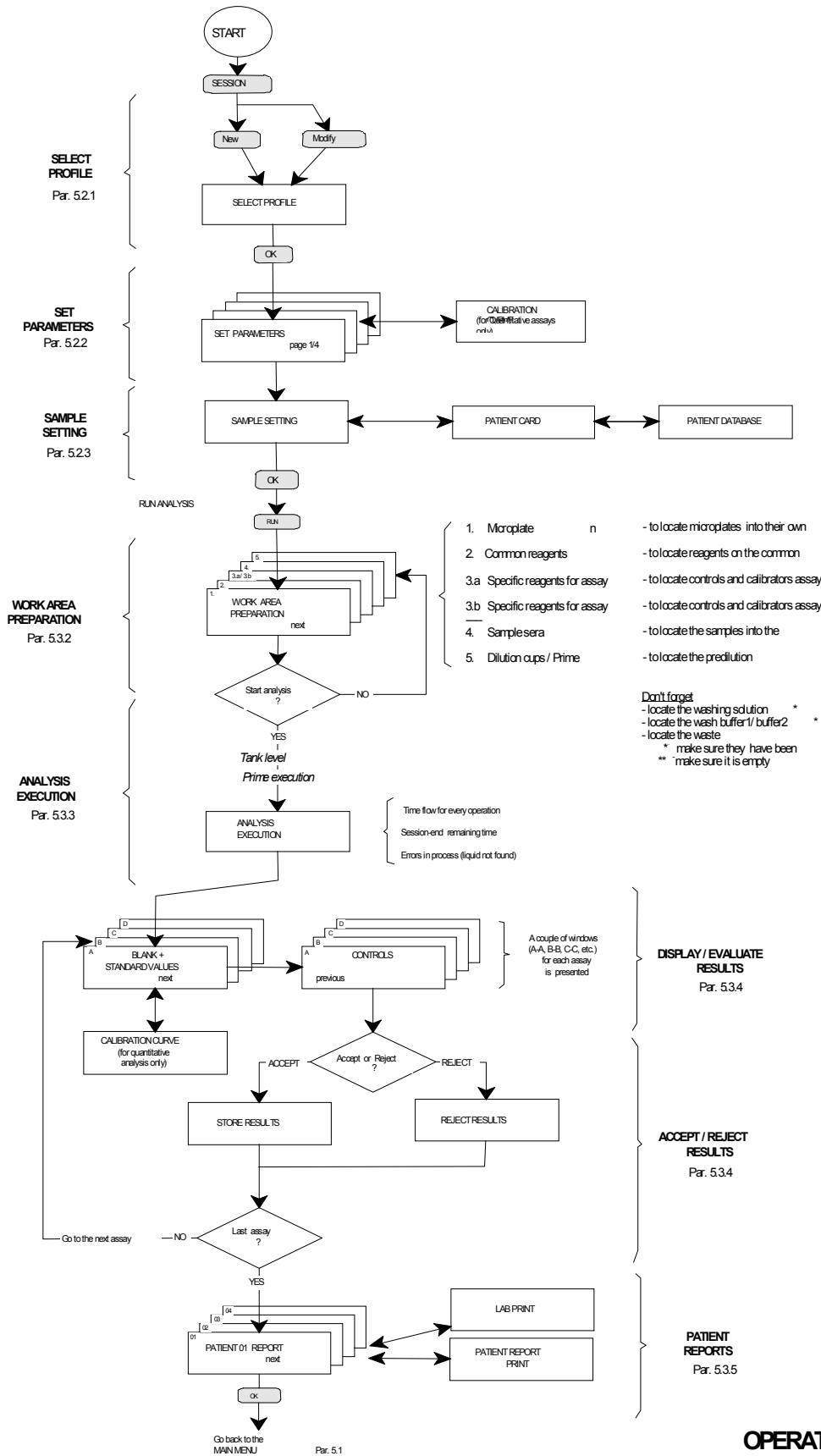

OPERATING FLOW DIAGRAM

Human
Gesellschaft für Biochemica
und Diagnostica mbH
Max-Planck-Ring 21 • D-65205 Wiesbaden
Germany
Telefon: +49 6122 9988 0
Telefax: +49 6122 9988 100

eMail: human@human.de
Internet: <http://www.human.de>