



# NEVO+600 SERIES

- Modular
- Configurable
- Reduced fan noise
- Enhanced Line Derating



*600 watt in the palm of your hand*

The enhanced NEVO+ series features improved low input line derating delivers 600 watts without the need to derate for line voltages above 120Vac making the NEVO+ the ultimate power solution for products destined for the global market. Through the implementation of a fan control circuit the NEVO+ also features reduced fan noise. The NEVO+ delivers up to 600 watts from a 600 gram 5" x 3" x 1U package and consists of an input module together with up to eight isolated output modules. The series carry full UL60601 3<sup>rd</sup> ED safety approvals and comply with EN61000-3, EN61000-4 and EN55022-B EMC standards.



## MAIN FEATURES:

- ✓ No Line derating above 120VAC
- ✓ Reduced fan noise
- ✓ 600 watt output
- ✓ 5" x 3" x 1U footprint
- ✓ High power density (25W/in<sup>3</sup>)
- ✓ UL 60601 3<sup>rd</sup> ED
- ✓ High reliability
- ✓ High efficiency – up to 89%
- ✓ Only 0.6kg – 100W/kg
- ✓ I<sup>2</sup>C control option
- ✓ Remote current/voltage programming
- ✓ Current output signal
- ✓ Accurate current sharing
- ✓ 5V 200mA bias supply
- ✓ RoHS compliant
- ✓ Field configurable
- ✓ Two year warranty

## SYSTEM SPECIFICATIONS

INPUT ELECTRICAL						
Parameter	Details	Min	Typ	Max	Units	
AC Input Voltage	Nominal range is 100Vrms to 240Vrms	85		264	Vrms	
AC Input Frequency	Contact factory for 400Hz operation.	47	50/60	63	Hz	
DC Input Voltage	Medical	120		300	Vdc	
Power Rating	See graphs for deratings			600	Watts	
Input Current	600Watts output at 120Vrms input			6	Amps	
Inrush Current	265Vrms (cold start)			20	Amps	
Fusing	5x20 Fast acting			8	Amps	
Input Current Limit	Maintains power factor		8		Amps	
Efficiency	See graphs		86	89	%	
Idle Power	All outputs fitted and enabled		28		Watts	
Idle Power	All outputs fitted and Disabled		21		Watts	
Power Factor	Typical value for 300Watts output at 240Vrms input		0.96	0.99		
Holdup	600Watts output at 120Vrms input	17	20	21	mS	
UVLO	Turn on only	78		84	Vrms	
Over temperature	Internally monitored. Latching	115		125	°C	
Reliability	40°C 80% load			2	FPMH	
Signals	Bias Voltage	4.8	5	5.2	V	
	Bias current	0		200	mA	
	Power Good voltage	PNP open collector with internal 10k pull down resistor	8	10	15	V
	Power Good current		0		20	mA
	Inhibit voltage		2		15	V
	Inhibit current	10k ohm input impedance	0.2		1.5	mA
	Global inhibit voltage		3		15	V
	Global inhibit current	5k ohm input impedance	0.6		3	mA
	AC_OK voltage		1		4	V
	AC_OK current		-10		20	mA
AC_OK warning	See user manual for exceptions	5			mS	

INSTALLATION			
Parameter	Details	Parameter	Details
Equipment class	I	Flammability rating	94V-2
Installation category	II	IP Rating	IP10
Pollution degree	2	ROHS Compliance	2002/95/EC
Material group	IIIb (indoor use only)		

RELIABILITY				
Component	Details	Min	Max	Units
FAN	Mag Lev Std		2.7	FPMH
INPUT	Excluding FAN		2	FPMH
OUTPUT	See individual output datasheets		1	FPMH
Warranty			2	Years

SAFETY				
Parameter	Details	Min	Max	Units
Isolation Voltage	Input to Output		4000	Vac
	Input to Chassis		1500	Vac
	Output to Chassis		250	Vdc
Isolation Clearance	Output to Output		250	Vdc
	Primary to Secondary (Reinforced)	7		mm
Isolation Creepage	Primary to Chassis (Basic)	2.5		mm
	Primary to Secondary (Reinforced)	12		mm
Leakage Current	Primary to Chassis (Basic)	4		mm
	Medical: 265Vac, 63Hz, 25°C		300	uA

MECHANICAL	
Parameter	Details
Size	77.7mm x 133.7mm x 41.0mm (all external dimensions ± 1.0mm)
Weight	360 gram +60 gram per output module
Mounting	Bottom or Side mounting (See diagram for details)



**MEDICAL  
DATASHEET**

# NEVO+600 SERIES



ENVIRONMENTAL						
	Parameter	Details	Min	Max	Units	
Storage	Temperature		-40	+85	°C	
	Humidity	Relative, non-condensing	5	95	%	
	Altitude		-200	5000	m	
	Air Pressure		54	106	kPa	
Operation	Temperature	Full power Derate input and outputs at 2.5%/°C	-20	50	°C	
	Humidity	Relative, non-condensing	5	95	%	
	Altitude	(-200 to 2000m for UL60601-1)	-200	3000	m	
	Air Pressure		78	106	kPa	
	Noise Level	Variable. Measured 1m from fan intake	35	60	dBA	
	Shock	3000 bumps at 10G (16ms) half sine wave				
	Vibration	1.5G 10 to 200Hz sine wave, 20G for 15min in 3 axes random vibration				

AGENCY APPROVALS	
Standard	File
IEC 60601-1: 1998 + A1: 1991 + A2: 1995	UL: E316486
UL60601-1: 2006	
CAN/CSA-C22.2 No. 60601-1 (2008)	
ANSI/AAMI ES60601-1 (2005 + C1:09 + A2:10)	
CE MARK - LVD 2011/65/EU	
CB certificate and report available on request	

EMC			
	Parameter	Standard	Level
Emissions	Radiated electric field	EN55011, EN55022, FCC	B
	Conducted emissions	EN55011, EN55022, FCC	B
	Harmonic Distortion	EN61000-3-2	Compliant
	Flicker & Fluctuation	EN61000-3-3	Compliant
Immunity	Electrostatic discharge	EN61000-4-2 (15kV air, 8kV contact)	4
	Radiated RFI	EN61000-4-3 (10V/m)	3
	Fast Transient burst	EN61000-4-4 (4kV)	4
	Input line surges	EN61000-4-5 (1kV L-N, 2kV L-E)	3
	Conducted RFI	EN61000-4-6 (10V)	4
	Power Freq. Magnetic Field	EN61000-4-8 (10A/m)	3
	Voltage Dips	EN61000-4-11 (EN55024)	Compliant

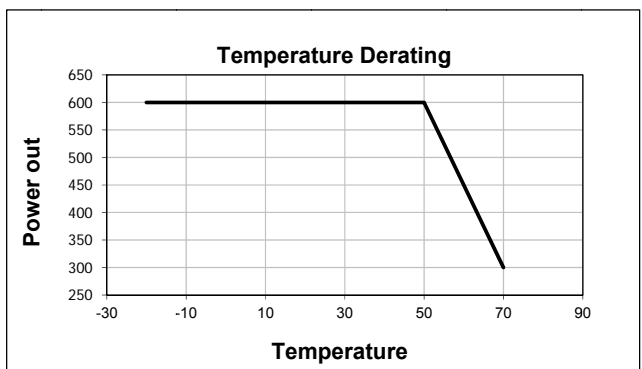
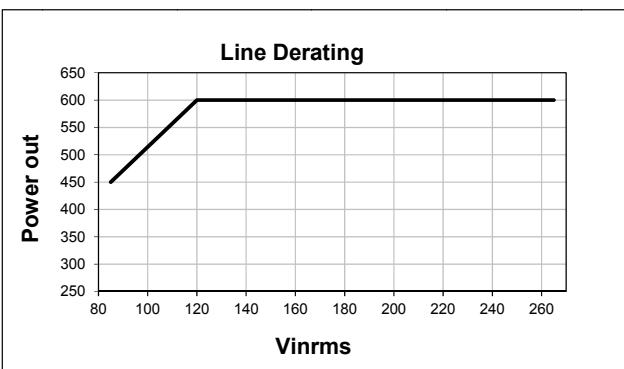
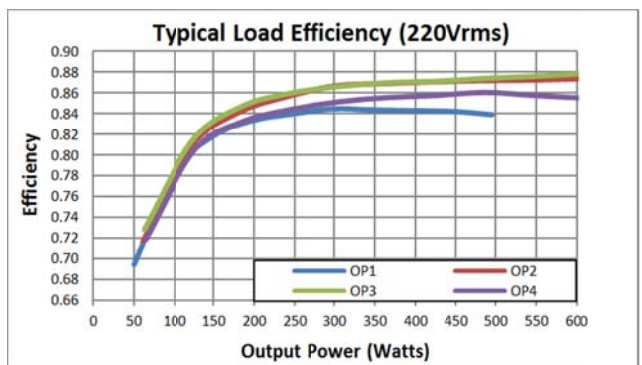
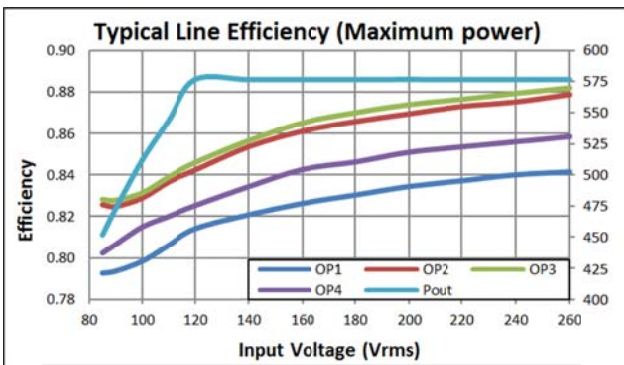
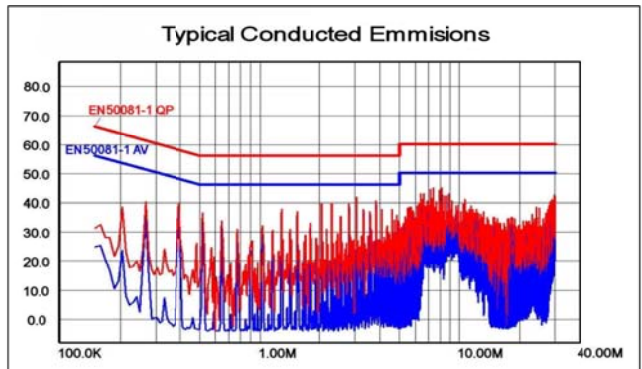

MECHANICAL DIMENSIONS AND MOUNTING SCREWS

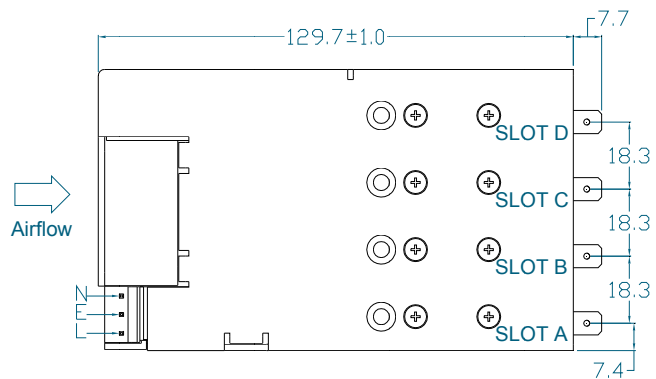
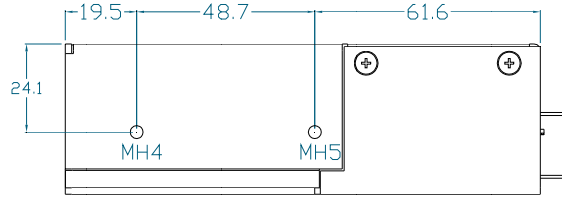
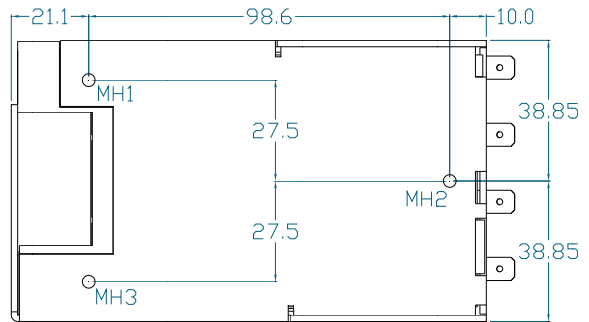
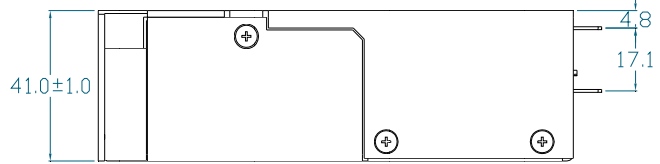
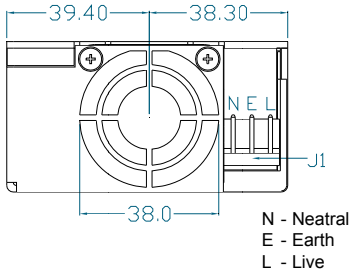

SCREWS	
MH1, MH2, MH3, MH4, MH5	
Screw type	M4
Tightening	Tighten to 1.5 Nm
Penetration depth	4.00mm max including chassis
OUTPUT MODULES x 8	
Screw type	M3x5, C/Sink, Posi, Stainless Steel
Tightening	Tighten to 0.75 Nm
Penetration depth	Defined by screw
CHASSIS x 5	
Screw type	M3x5, C/Sink, Posi, Stainless Steel
Tightening	Tighten to 0.75 Nm
Penetration depth	Defined by screw
FAN x 2	
Screw type	M3x30, C/Sink, Posi, Stainless Steel
Tightening	Tighten to 0.75 Nm
Penetration depth	Defined by screw

## CONNECTORS

PINOUTS		
<b>J1</b>		
Circuit	Details	
1	Live	
2	Earth	
3	Neutral	
<b>J2</b>		
Circuit	Details	
1	Power Good	Slot A
2	Inhibit	
3	Power Good	Slot B
4	Inhibit	
5	Power Good	Slot C
6	Inhibit	
7	Power Good	Slot D
8	Inhibit	
9	Global Inhibit	
10	AC OK	
11	+5V 200mA Bias Supply	
12	COM	
<b>J5</b>		
Circuit	Details	
1	-Sense	
2	+Sense	
3	Voltage Control	
4	Current Control / Share / Out	
5	COM	
6	+5V local bias supply	

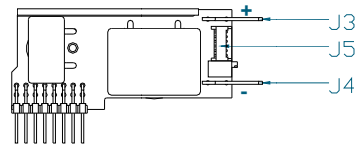
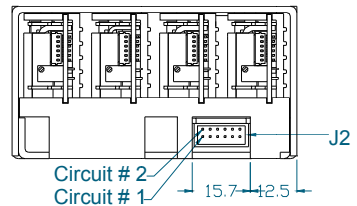
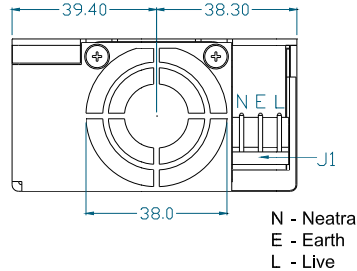

J3
Positive Output
J4
Negative Output

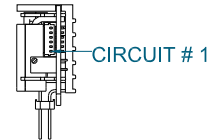

REF.	DETAILS	MANUFACTURER	TERMINAL
J1	MAINS INPUT: 3 Pin, 5.08mm, with Friction Lock, 18-24 AWG	MOLEX	10013036
J2	GLOBAL SIGNALS: 12 Pin, 2mm, with Friction Lock, 24-30 AWG	MOLEX	511101260
J3/4(1)	OUTPUT POWER TERMINAL: TAB SIZE 6.35mmx0.8mm	VARIOUS	VARIOUS
J5	OUTPUT SIGNALS: 6 Pin, 1.25mm, with Friction lock, 28-32 AWG	MOLEX	0510210600

**Notes**

1. Terminal and Wire current rating must exceed maximum short circuit output current. Eg. Output 1 = 25A\*1.25 = 31.25Amps
2. Direct equivalents may be used for any connector parts
3. All cables must be rated 105°C min, equivalent to UL1015

## PART NUMBERING SYSTEM

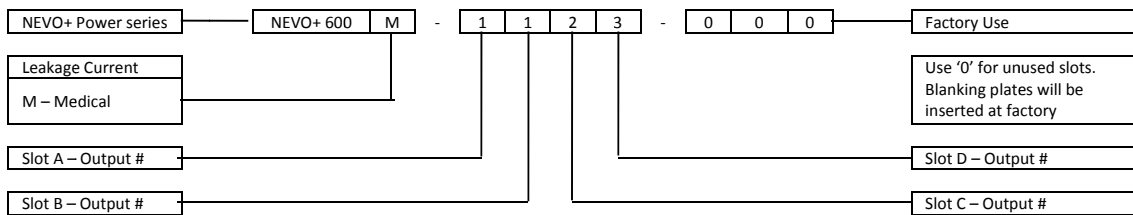

When initially ordering non-nominal voltage settings add "/Voltage" after each output # where a special voltage setting is required  
E.g. If 3.30Vdc is required in slot B and all other slots require nominal voltages then use:

**NEVO+ 600M - 1 - 1/3.30 - 2 - 3**

The factory will then issue a 3 digit code for your specific configuration that can be used for all future orders of the same configuration  
When ordering an input unit with no outputs inserted, simply order NEVO+ 600M

Vox Power Ltd. reserves the right to change or improve any part of the specification, electrical or mechanical design or manufacturing process without notice. Please consult your local distributor or contact Vox Power to ensure that you have the latest specification before using your product. For other information relating to the use of the product please refer to the latest NEVO user manual. Vox Power reserves the right to make changes without notice to any of its products. Vox Power does not assume any liability arising out of the use or application of any of its products and of any information to the maximum extent permitted by law. No license, express or implied, by estoppel or otherwise, to any intellectual property rights is granted by this document or by any conduct of Vox Power. VOX POWER DISCLAIMS ALL WARRANTIES AND REPRESENTATIONS. IN PARTICULAR ALL OTHER WARRANTIES, CONDITION OR TERMS RELATING TO SUITABILITY, FITNESS FOR PURPOSE, MECHANABILITY OR CONDITION OF THE PRODUCTS AND WHETHER EXPRESS OR IMPLIED BY STATUTE OR COMMON LAW OR OTHERWISE ARE EXCLUDED.

Document DOC6008 rev 04