Menu

A.	Packaging	1
B.	Characteristics:	2
C.	Specification sheet.....	3
D.	Product appearance	7
E.	Installation of SD card.....	8
F.	Cable Installation	9
G.	Installation diagram.....	11
H.	IR remote control	13
I.	Recording	14
J.	Live View:.....	15
K.	PC Player.....	16
L.	Data backup	18
M.	Configuring the Memory Disk.....	20
N.	Google Map track playback	22
O.	Data Playback.....	23
P.	Screenshot tool.....	26
Q.	WiFi Connection.....	28

Safety Precautions

To Whom It May Concern

Thanks for your patronage. Please contact your local dealer for any assistance. We will backup services via local dealers. Rights are reserved to upgrade software and hardware without notice beforehand. Please read this manual prior to use of this product.

Installation Precautions

- Make sure power connections clear enough to you before installation.
- System installation is required professional installers and ventilation space.
- Please use recommended and genuine storage device.
- Please contact local dealers in case of service requirement.

In Use Precautions

- Please keep the inner components off any solid or liquid.
- Please do not disassemble the equipment for warranty issue.
Please contact local dealers or the manufacturer for prompt service.
- Please remove the battery if remote control keeps idle for quite a long while.
- The equipment best connects with ground wire in case of outdoor cameras connection or alarm I/O connection. This is to keep the DVR away from static electricity damage.

Surrounding

- Please have the DVR under recommended temperature away from the sun and heating source.
- Please keep this equipment away from humid surrounding.
- Please keep this equipment away from smoke and dust.
- Please do not drop the equipment.
- Please keep this equipment in ventilation space.
- Please supply rated voltage and Amp. To the equipment.
- Please keep flammable objects away from the equipment.

A. Packaging

1. Accessories

- Power cable
- Multi-functional OBD display (built with GPS and microphone)
- WiFi antenna
- Velcro tape
- IR remote controller
- Car camera x 2pcs
- 3.5M camera cable x 2pcs
- Driver CD
- Quick guide

2. Optional Accessory

- SD card reader
- SD card, 8GB or above, class 10 or above

3. Review

Please review the package first. The packaging material can resist impact during delivery. Please remove the PE bag to make sure no damage on the housing. Finally make sure the screws are not loose.

■ Front Panel and Rear Panel

Keypad on the front panel and port on the rear panel are described in manual. Please make sure the model number on the label comes to the same as the model you purchase. Product labeling has significant meaning to after sale service. You will be asked to provide model number and serial number the time you contact our service team.

B. Characteristics:

1. Aluminum casing make it durable and waterproof.
2. Small independent system, 2 channels video and 1 channel audio recording.
3. H.264 compression format, 720P video resolution.
4. Low power consumption and efficient heat dissipation, no build-in Lithium battery to prevent possible danger and heat explosion.
5. Devices starts recording automatically when engine is on, file is well formatted and saved securely with extension recording by super capacitor.
6. GPS tracking and G-sensor data is to displayed on PC player Carbox player on Google Map for up-to-date geographic information.
7. Build-in WiFi connection for mobile phone application to display, playback and backup file directly.
8. Made in Taiwan.

C. Specification sheet

● CAR DVR

Item	Specification
Video Input	2CH 720P
Resolution	720P
Power Consumption	(a) DC12V input, power consumption is approx. 1A. (b) DC12V input, ACC OFF standby power consumption is approx. 30mA. (c) Operation voltage: DC10.0v ~ DC14.5v. (d) Initial voltage: DC11V above.
Prolonged Recording	(a) Extensional power supply for 3 seconds after ACC OFF. (b) Build-in super capacitor.
Temperature Tolerance	Operation -20°C ~ 60°C (In disclosed space) . Storing temperature: -40°C ~ 85°C.
Storage Device	Suggest to use SanDisk Class 10, 8GB storage and above SDHC Card, max. to 128GB.
Recording mode	Continuous recording after power ON.
Data Content	Video, date, time, audio, GPS, external alarm trigger log, G-Sensor.
Storage Format	Secured data format, please use suggested player. Playback available on DVR device.
Audio Input	Secured data format, please use suggested player.
Time Setting	GPS time zone auto calibration, and initialize with build-in calendar if no GPS signal. Please do GPS time calibration after installation, time memory is kept with car battery, no battery power supply will result setting return to default, please do time calibration after connecting to power.
Display Mode	TV-Out

<p>OBD Indicator</p>	<p>(a) Green light flashing: recording. (higher flashing frequency for event recording). (b) Blue flashing: F/W updating. Red light on means device error. (c) Blue light: WiFi connection.</p>
<p>Input</p>	<p>(a) Power and signal input: i. Power input DC12V ii. ACC signal: power input range DC10.0v ~ DC14.5v ◦ iii. LAMP signal: power input range DC10.0v ~ DC14.5v for external alarm triggered event recording. (b) Video input: please protect with waterproof tape on connectors after cabling. (c) Other: GPS, speed, microphone audio input. (d) WiFi (e) Infrared remote control reception. (f) SD card socket.</p>
<p>Explanation</p>	<p>(a) Please install device by professional installation engineer; temporary installation is suggest to fixed with tape included; please take high attention from damaging motor oil and power supply. (b) Please keep device cabling from gasoline tube and oil tank; please install DVR when engine is off. (c) Please don' t use micro-SD adaptor as recording device, it may cause intermittent recording and unstable connect from driving vibration. (d) Please use tape to seal connector well after cabling in order to prevent cabling loosens and dirt, oil, water from entering. (e) All cabling should be installed with fuse protection. (f) DVR should be fixed well to prevent moving and causes device from damages.</p>

	(g) GPS positioning precision is interfered by installation position and weather condition.
Attention	<p>(a) Camera video and signal may be electromagnetic interfered of installing on non-EMC certified vehicles.</p> <p>(b) Please use alcohol to clean cable connectors to eliminate dust, mud, oil, ...etc. to ensure signal transmission and video quality.</p> <p>(c) NTSC or PAL frequency should be set according to local TV system.</p> <p>(d) The machine consumes micro electric current when standby. If the vehicle wouldn't be used for long time, please remove DVR power to prevent power consumption to car battery. User needs to do time calibration after reconnect the DVR to car battery.</p> <p>(e) Boot screen and OSD interface is subject to change according to software update or revision change without notice.</p> <p>(f) Please remove the card and set to lock-state to avoid being overwritten for important event or accident records.</p> <p>(g) Please shut off power before installing or removing cameras to protect from electric surge or short.</p> <p>(h) DVR shuts off when ACC power is off, and DVR time setting is rely on car battery.</p>

● CAR CAMERA

Power	DC5V~DC12V \pm 10% input / Power Consumption 500mA
Resolution	Support NTSC / PAL , 30FPS @ 1280x720
Image Sensor	1/4" CMOS sensor
View Angle	H: 110° / V: 55° / D: 130°
Lens	3.6mm (optional)
Temperature	Operation -20°C ~ 60°C (In disclosed space) .
Tolerance	Storing temperature: -40°C ~ 85°C.
Output terminal	SMA harness plug
Size	30x43x50mm

Notes : The product specification is subject to change without prior notice.

D. Product appearance

- Mobile DVR unit:

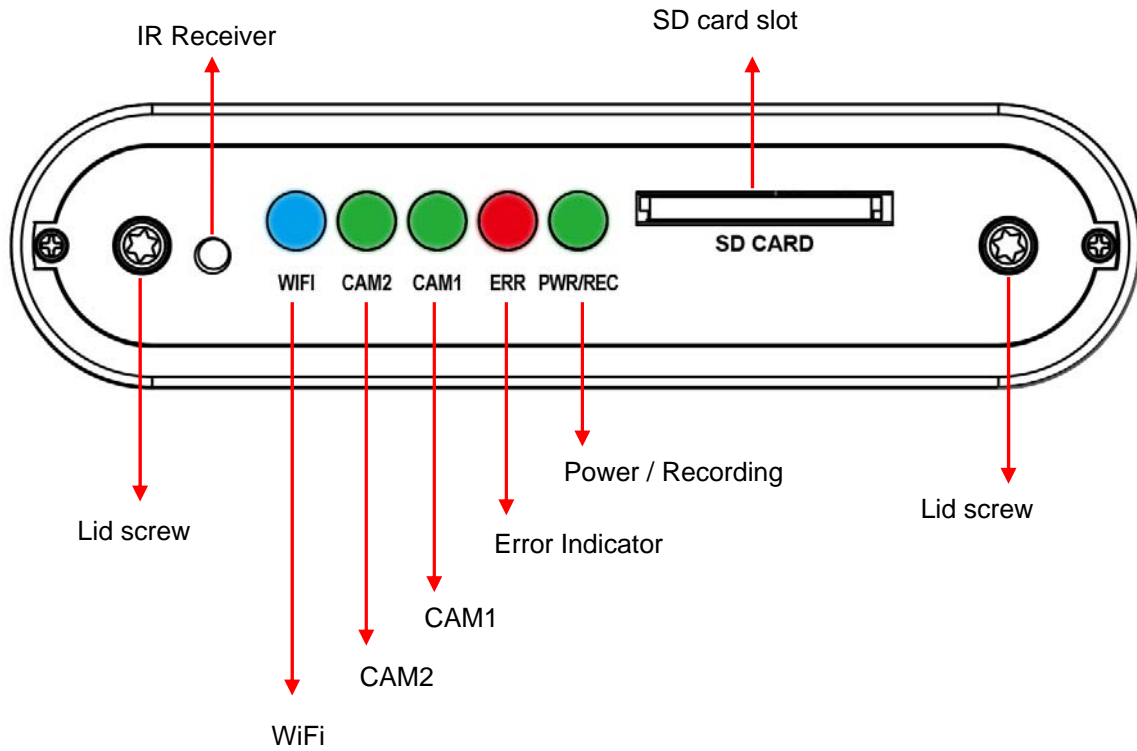

- OBD (On Board Display)

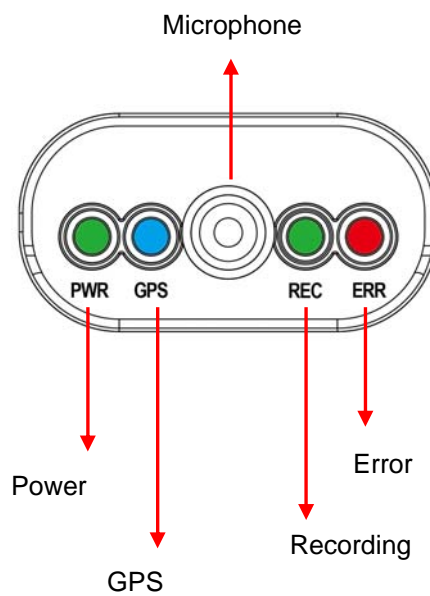

E. Installation of SD card

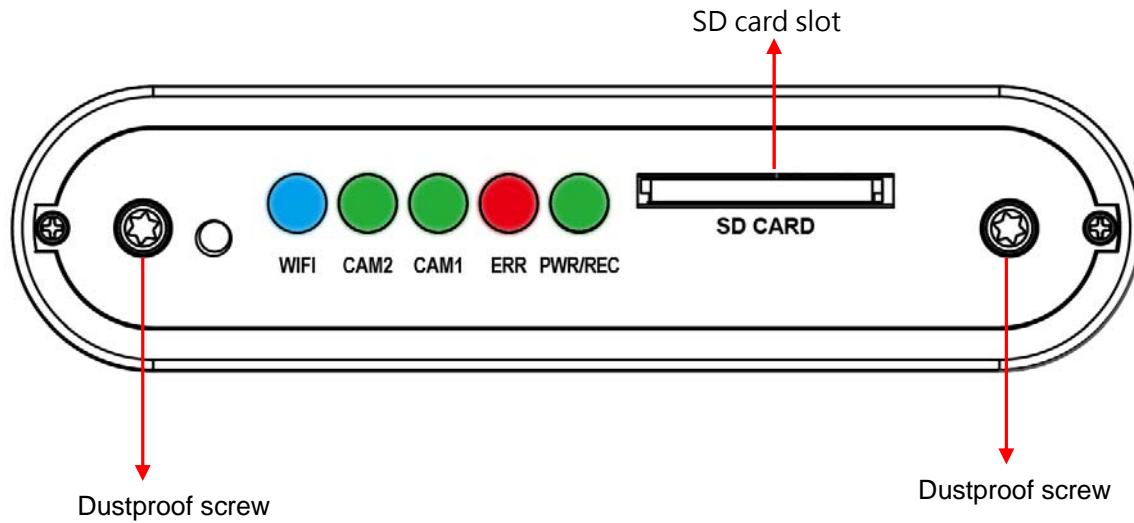

- (1). Counterclockwise to unscrew the screw of dustproof lid to install/takeoff the SD card.
- (2). Please do SD card format/ restoration with attached player.



Attention

- (1). Suggest to use SanDisk or Transcend SD card class 10, 4GB above.
- (2). Before using the memory disk, please format the disk first by using the software player in the CD-ROM. If not, device will automatically erase all data in the memory disk before recording.
- (3). To ensure recording quality, please do not use adapter card with Micro SD card. Doing so may lead to bad connection due to shock and vibration.
- (4). All memory disks have limited lifespan. Please regularly watch videos on PC and check the memory disk to ensure proper functioning.
- (5). Collision and vibration may cause SD card defective and result intermittent recording, please check data and backup file periodically.

F. Cable Installation

● Cables



- (1) Multi-functional OBD display connector
- (2) Power connector
- (3) Camera 1 connector
- (4) Camera 2 connector
- (5) Video out
- (6) WiFi antenna

Note: Please use LVDS camera

● Power cable

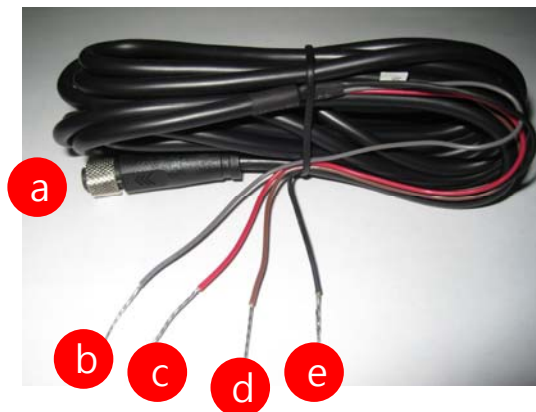

- (a) Power connection: reception
- (b) Alarm recording (Grey cable): connect to +12V power to do event recording by alarm triggered. Can be used together with switch.
- (c) Power cable (Red): connect to power positive connector.
- (d) ACC activation cable (Brown): connect to motorcycle power switch (+).
- (e) Ground (Black): connect to power supply (-).

- OBD

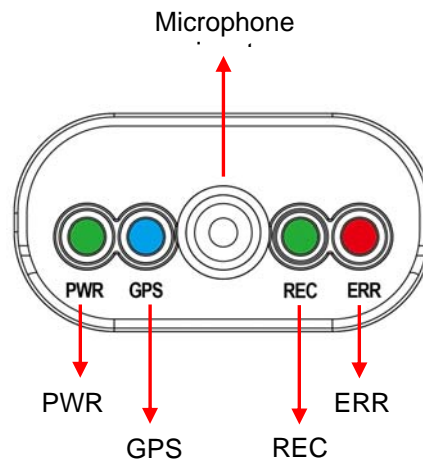

- (A) PWR (Green) : power indication.
- (B) GPS (Blue) : Flashing mean GPS 3D positioning searching. Consistent blue light on means 3D positioned successfully.
- (C) Microphone : Audio input.
- (D) REC (Green) : Flashing means continuous recording.
- (E) ERR (Red) : Error diagnosis, please check camera signal, OBD display, SD storage...status.

- WiFi Antenna



G. Installation diagram

- Installation on motorcycle



Attention

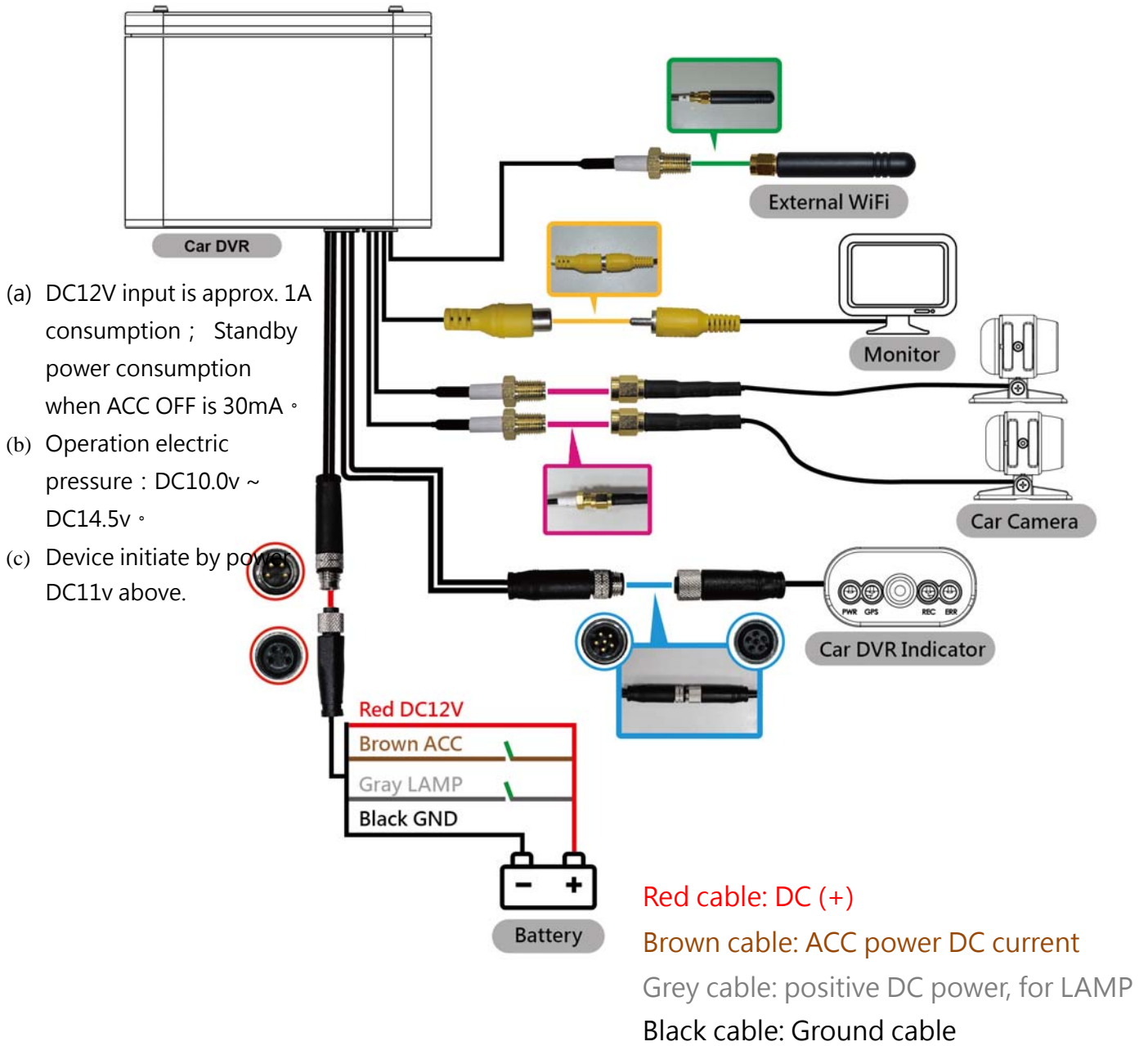

- (1). Please install this device with the help of professional technician to avoid damaging your vehicle.
- (2). For installation by none-technician, please use tapes instead of boring tools to avoid damaging the electrical and gasoline system.
- (3). For safety, switch off ignition before installation, and please keep away from gasoline pipeline and tank.
- (4). Before inserting wires through holes, temporarily wrap the terminal with tape to prevent bad connection from accumulated dirt or debris.
- (5). Tightly seal all electrical connection with tape to prevent loose connection or leak leaking to the connection.
- (6). Connect the power behind the key ignition and fuse (not directly to the vehicle battery) to avoid depleting the battery.
- (7). The device should be fixed to the vehicle. Tumbling inside the storage trunk will damage the device.
- (8). GPS positioning accuracy may be affected by the installation position, sun-screen or weather condition.

● DVR installation diagram

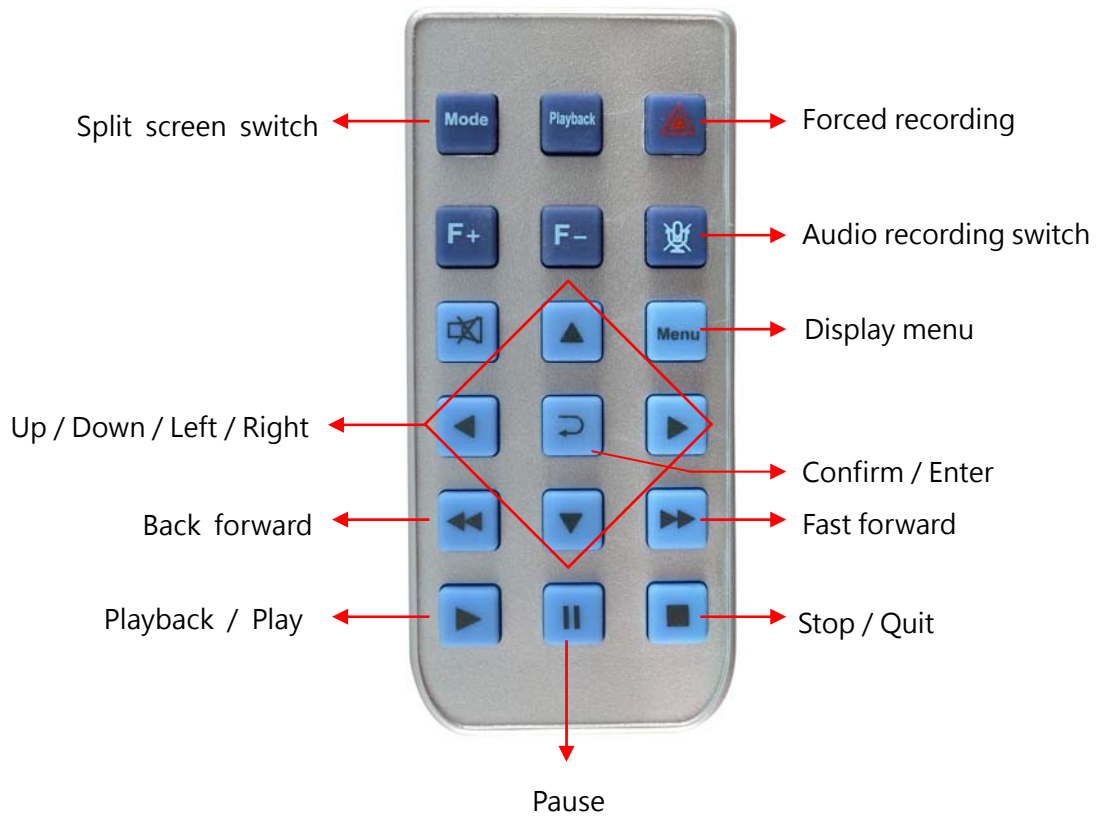

H. IR remote control



Icon	Function	Description
	Split screen switch	Single, Duo screen switch
	Forced Recording	DVR saves record to protective area for record before and after event by pressing the emergency button. The protective area is reserved as 20% of total storage and prevent data from being overwritten.
	Audio recording	Audio recording ON/OFF

I. Recording

1. System initialization / Recording:

System initializes within 30 seconds when power is on. PWR green light ON when system is rebooting. System starts to recording when REC green light is flashing.

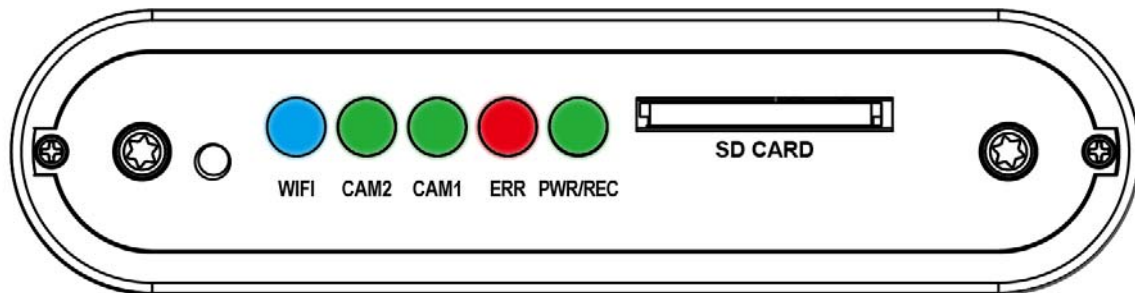

Light Indication:

- PWR/REC : **GREEN** on means device POWER is on, Flashing resembles recording.
- ERR : **RED** on means abnormal, please check possible reason such as camera signal, HUD display, SD card ...etc.
- CAM 1 : **GREEN** means in connection, **RED** means connection failed.
- CAM 2 : **GREEN** means in connection, **RED** means connection failed.
- WiFi : **BLUE** means WiFi module standby, available for connection.

2. Shut off/ Stop recording

Device offer prolonged 3 seconds recording after power off to ensure data is well stored; user can take out the SD card when indication is off.

J. Live view:



1. If the screen shows on top right, it means that both channel 1 (left) and channel 2 (right) have video signal. A icon indicates that one channel has no video input. shows the audio recording is shut off.

2. Event recording: when shows in LIVE mode mean normally recording, when press on remote controller, it shows on right side up to represent it is under manual recording. And when it shows means G-Sensor triggered recording.

3. User can press to switch to channel 1, 2 on LIVE mode, as below image:



CH1 image



CH2 image



CH1 and CH2

4. Press on the remote controller in LIVE mode to show firmware version :

Firmware Version : 1002

5. Press on the remote controller to turn off audio recording (will show on the screen). A icon indicates that audio recording is on.

6. A icon means either that the device is calculating coordinate or that there is no satellite signal. A icon means that GPS is ready.

K. PC player

Run the player software  (included in the CD).

©NOTE: The software requires Direct X version 9.0 or above.

1. Viewer Interface



1	CAM1
2	CAM2
3	Speed display
4	G sensor
5	Google Map / File list
6.7	Operation control interface
8	Volume control
9	Play speed
10	Time bar/ File mark

2. G SENSOR

G sensor analyzer is to recording the vehicle moving information.

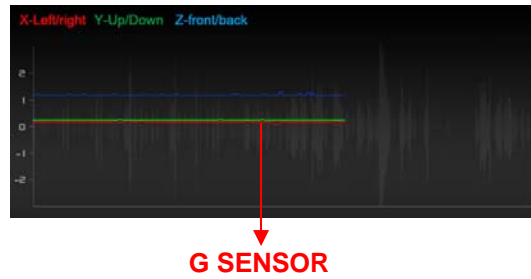

- (1) **X** : Left and right movement
- (2) **Y** : Front and rear movement
- (3) **Z** : Vertical movement

Note : 3 axis direction varies according to device posture of installation.

3. Control bar



	Start point of backup
	End point of backup
	Screenshot
	Open file
	File backup
	Device settings
	Tool box, memory card formatter, language setting.



	Previous file
	Previous frame
	Back play
	Pause

	Stop
	Play
	Next frame
	Next file

L. Data backup

Save data from SD card to PC or other device.

Use PC player and click  to enter backup interface:

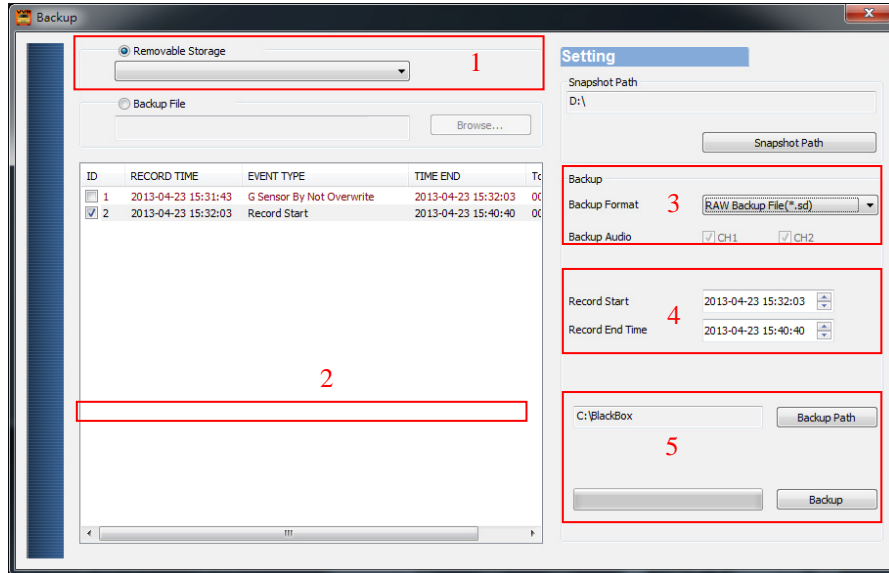

Step1. Choose SD card source:

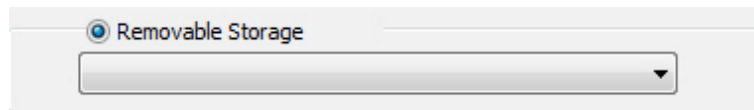

Step2. Choose backup files

ID	RECORD TIME	EVENT TYPE	TIME END	Tc
<input type="checkbox"/> 1	2013-04-23 15:31:43	G Sensor By Not Overwrite	2013-04-23 15:32:03	00
<input checked="" type="checkbox"/> 2	2013-04-23 15:32:03	Record Start	2013-04-23 15:40:40	00

Step3. Choose backup data format

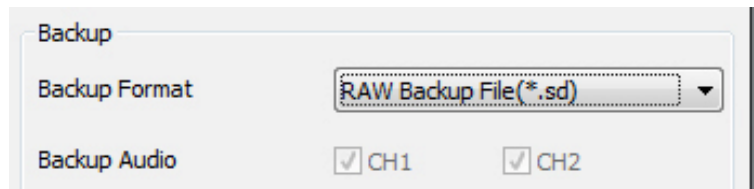

Data format :

(1) SD card original format (RAW)

<input type="checkbox"/> 2014-05-27-18-10-03.sd	RAW file *.sd
---	---------------

(2) AVI Format (*.avi)

2014-05-27-18-11-07-Cam1.avi	Cam1, *.avi file
2014-05-27-18-11-07-Cam2.avi	Cam2 *.avi file

Note: backup to memory card in original format, the format will be containing GPS latitude and longitude, speed, recorded data such as G-SENSOR, if the backup date in *.AVI format, it contains only video and audio, so back up in original format is recommended.

Step4. Select the backup beginning time point

Record Start	2013-04-23 15:32:03	▲ ▼
Record End Time	2013-04-23 15:40:40	▲ ▼

Step5. Select the path and start backing up

C:\BlackBox	Backup Path
	Backup

M. Configuring the Memory Disk

Please insert SD card into card reader and launch player on your computer to do card formatting.

Click  on player to do setting:

Choose disk

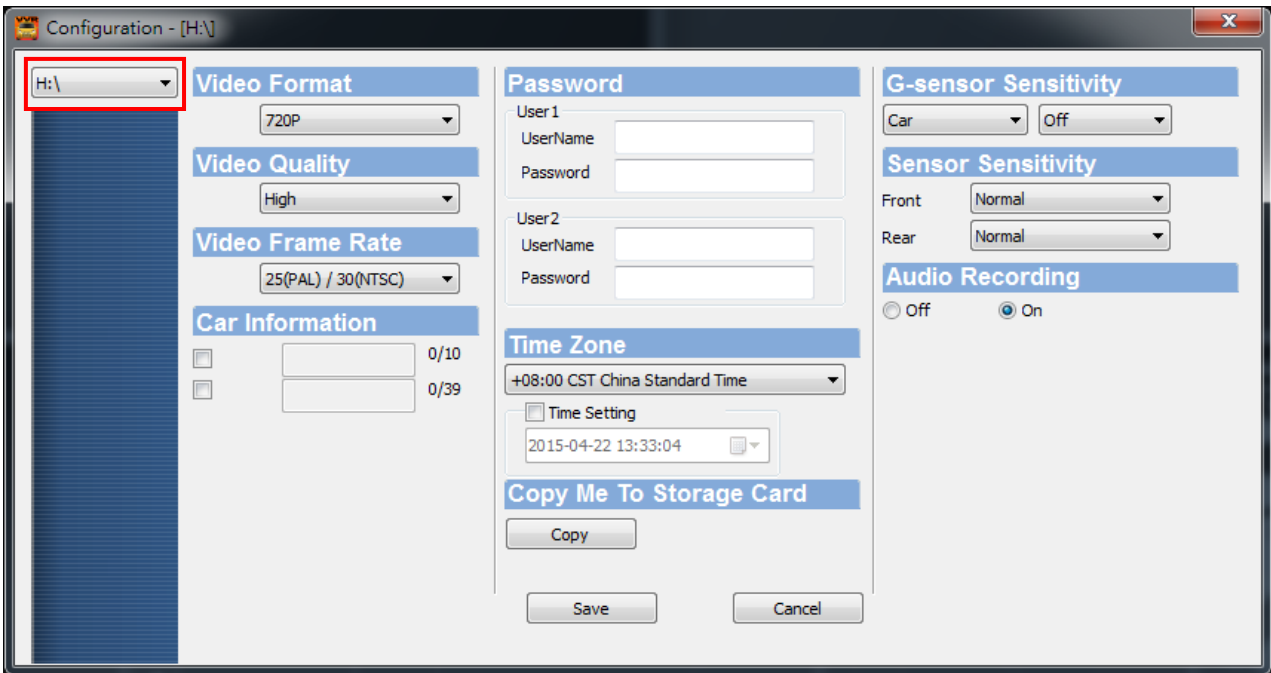

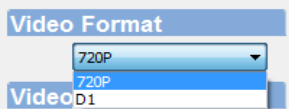
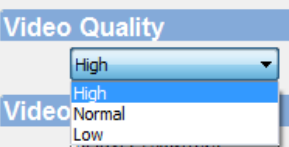
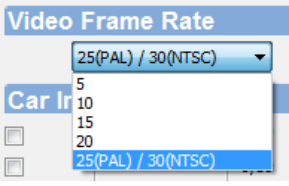
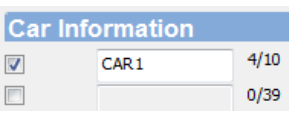
1	Video Format		Select video recording resolution: 720P, D1
2	Image Quality		Select video picture quality: High / Normal / Low
3	Number of Images		Setting the number of frames per second video camera recording: PAL (25,20,15,10,5) NTSC (30,20,15,10,5)
4	Car machine message		Identification message, can input car plate number or driver' s name...etc.

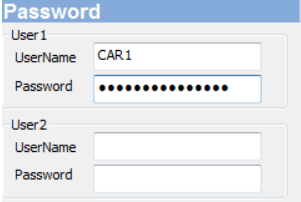
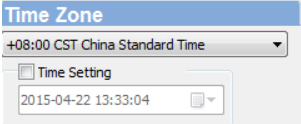
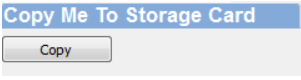
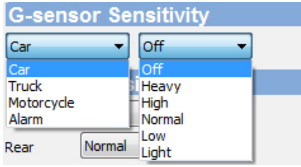
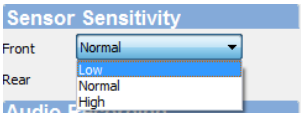
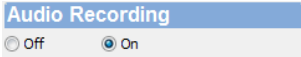
<p>5</p>	<p>Password Management</p>		<p>This feature can encrypt the memory card and to prevent unauthorized access. Password length allows to 15 characters.</p> <p>User have to key in password for video playback, settings, memory card format after password is set.</p> <p>★ Note: please keep password in safe and remembered place, SD card is accessible only when keyin correct password and no other way to unlock the file.</p>
<p>6</p>	<p>Time Setting</p>		<p>Please manual adjust time when in no GPS cover environment. Time zone would automatically calibrated to GMT time when GPS connect.</p>
<p>7</p>	<p>Copy to SD card player</p>		<p>Copy Player to SD card storage</p>
<p>8</p>	<p>G sensor</p>		<p>Use X-Y-Z axis vibration detection to determine the collision and forced recording.</p>
<p>9</p>	<p>Light sensitivity</p>		<p>Sensitivity: five levels: off / low / low / normal / high / very high.</p> <p>Nighttime illumination can be set based on sensitivity, set to low, medium, and high.</p>
<p>10</p>	<p>Sound Recording</p>		<p>Set audio record: OFF / ON</p>

N. Google Map track playback

If there' s GPS recording, user will be able to read driving path, direction, speed information when doing video playback.

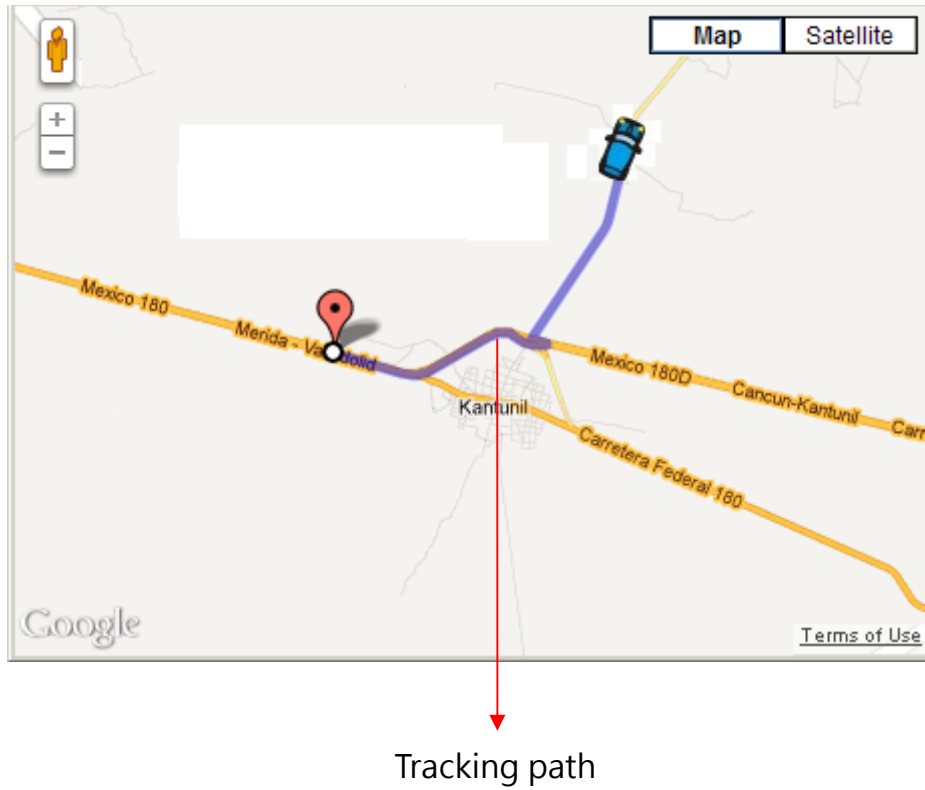









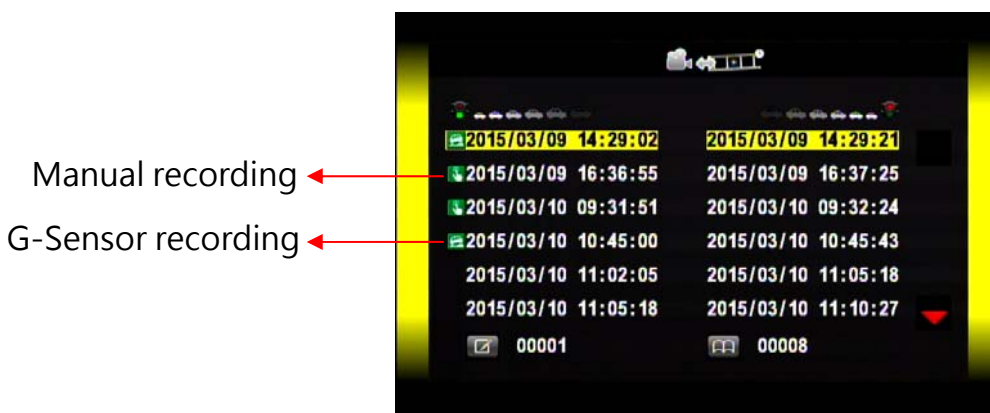

O. Data Playback

There' re two way to do video playback: 1) Playback via video out and 2) PC player playback.

1. On screen playback

Click  key on remote control in Live mode screen, it switches to playback mode event list like below; DVR stop recording when entering the playback page.



- (1). Press the  or  button to select the footage in the list
- (2). Press the  or  button to select the previous or next page of footage.
- (3). After the desired footage is selected, press  or  to play the video.
- (4). To pause video, press . To resume playing, press .
- (5). To stop playing and return to the playback list, press .
- (6). To stop playback and return to live recording mode, press  again.

2. Playback on PC player

Click  to enter playback mode:

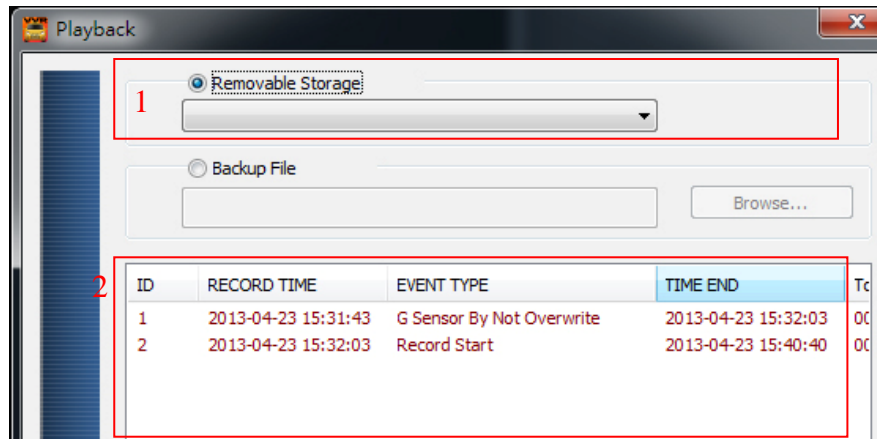

- (1). Select the path of the memory disk or a backup file on the hard disk.
- (2). Double click the desired footage to play the file.

(3). Image Snapshot

User can take a snapshot of the current frame by pressing  to save screenshot. The player will save the file to *.bmp format and open the destination folder:

Snapped image is default saved to /Snapshot, user can enter  to set image path. Data format is *.bmp

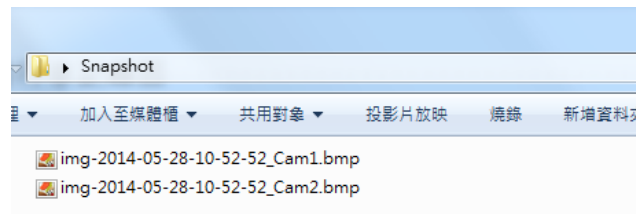
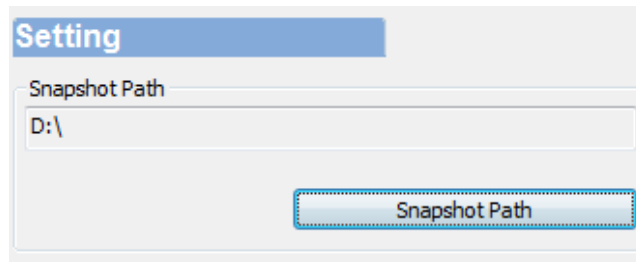

P. Screenshot tool

Q1. When do user need to format SD card?

When user uses brand new SD card, please format it before use.

Q2. When do user have to restore SD card?

If you want to repurpose the memory disk for other uses (e.g. for computer or digital camera), you need to restore the disk. All recorded data will be erased from the disk.

Attention



(1). Unlock SD card before formatting

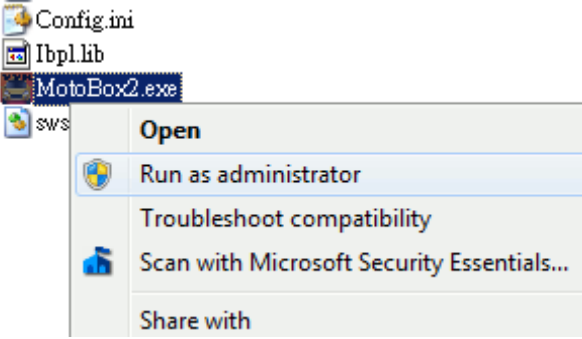

(2). Please use "RUN AS ADMINISTRATOR" to format SD card.



Q3. How to format/restore SD cards?

- (1). Put the SD card into a card reader and plug the card reader into your computer USB slot.
- (2). Play software , click  to enter formatting tool.

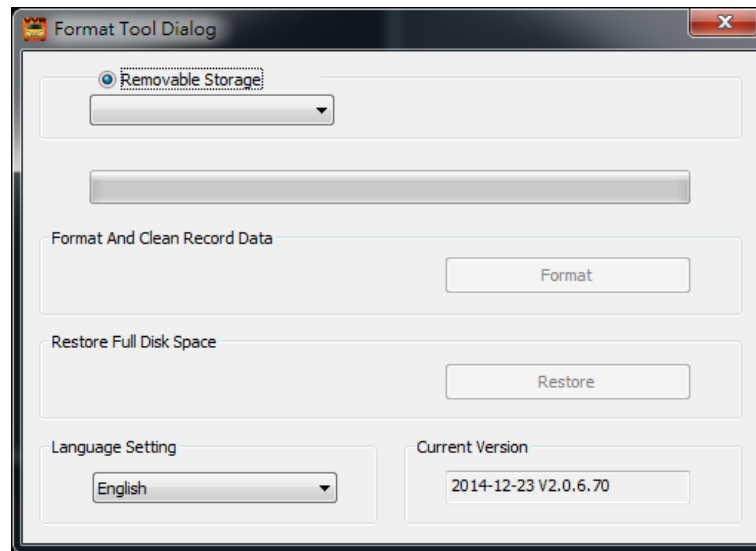

- (3). Select memory card location, and choose "format" or "restore" memory card

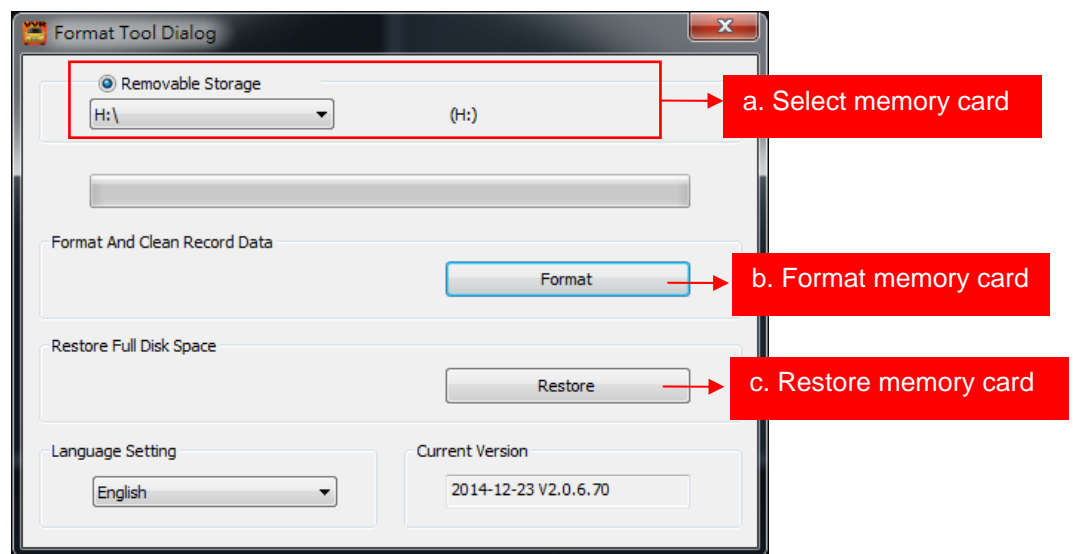

Q. WiFi Connection



1. Visit Google Play store and search for " VacronPlayer " and download.
2. Turn on WLAN name 「SSID」, password 「12345678」.
3. Run APP " VacronPlayer" , click "Device list" then "Add" , key in a preferred device name.
4. Click on device name and choose "All Channel" to see LIVE VIEW
5. Function: Live view image shot, Live recording, Video playback, Video backup.

Attention

- (1). There might be video transmission delay due to wireless transmission.
- (2). Please remember to restore WiFi setting to external network after using Vacron Player.



For more information
Please visit VACRON website
<http://vvr.vacron.com>

Made in Taiwan
