

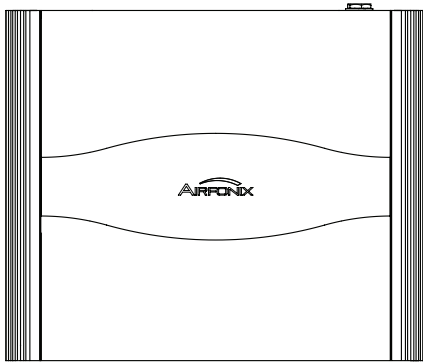

# User Manual

Airfonix R Series Wireless Receiver Models:

AFX-19AR050



AFX-19PR001

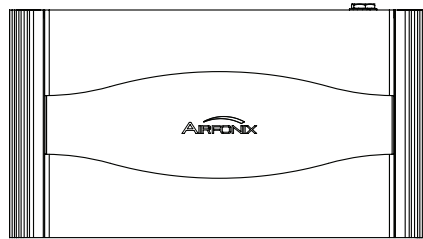

Airfonix T Series Wireless Transmitter Models:

AFX-19PT002

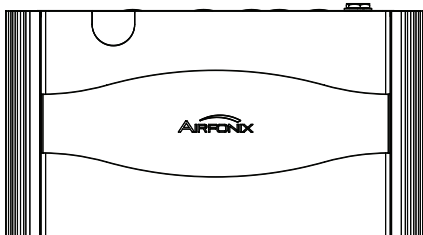

AFX-19PT102

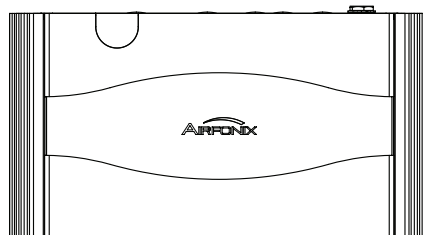

# Important Safety Instructions

**TO REDUCE THE RISK OF FIRE, ELECTRICAL SHOCK OR PRODUCT DAMAGE, DO NOT EXPOSE THE BOTTOM OF THE TRANSMITTER OR RECEIVER TO RAIN, MOISTURE, DRIPPING OR SPLASHING. PLEASE ENSURE THAT NO OBJECTS FILLED WITH LIQUIDS, SUCH AS VASES, ARE PLACED ON THE TRANSMITTER OR RECEIVER.**

**FOR YOUR SAFETY, READ AND RETAIN ALL SAFETY AND OPERATING INSTRUCTIONS. FOLLOW ALL WARNINGS IN THIS MANUAL AND ON THE UNIT.**

## POWER SOURCE

To avoid any malfunctions of the unit, and to protect against electrical shock, fire or physical injury, please observe the following:

- This system has been designed to work with 100-240 volt AC current. Connection to a line voltage other than that may create a safety and fire hazard and may damage the system. If you are unsure of the type of power supply to your home, consult your local dealer or power company.
- Do not defeat the purpose of the polarized plug. A polarized plug has two blades, with one wider than the other. The wide blade is provided for your safety. If the provided plug does not fit into your outlet, consult an electrician for replacement of the obsolete outlet.
- Do not run power cords under rugs or carpets or place heavy objects on them.
- Damaged or deformed power cords are hazardous and should be replaced immediately by a qualified service technician.

## LOCATION

- Air vents are provided in the cabinet to prevent the build up of excessive temperatures inside the unit. Do not place the unit in closed spaces, cover it with anything, or otherwise block the vents.
- Keep the units away from heat sources such as fire pits, heating vents, central heating radiators and electric heaters. Never expose to continuous direct sunlight.
- Keep the unit away from strong magnetic fields.

## CARE

- The unit is splash proof only. Do not submerge in water.
- Do not insert or drop anything into the unit through the air vents as this could cause serious damage, possibly resulting in fire.
- Do not place any object containing water or other liquids on the unit. In the event that liquid should enter the cabinet, unplug the unit at once and contact the retailer or service center immediately.
- Do not remove the cabinet. Touching parts inside the cabinet could result in electrical shock and damage to the unit.
- Unplug the unit and the AC power adapter from the electrical outlet during lightning storms or when unused for long periods of time to prevent damage.
- To avoid electrical shock and/or damage to the unit, do not handle the transmitter, receiver, external antenna, connecting cables or AC power adapter with wet hands.
- The AC power adapter receives power as long as it is connected to the electrical outlet, even if the power switch on the unit is turned off. Always remove the AC power adapter from the electrical outlet before inspecting the adapter.
- Use only the AC power adapter supplied with the unit. This adapter is designed specifically for the unit.

## NON-USE PERIODS

- ALWAYS turn the power OFF when not in use. When left unused for long periods of time, the unit should be unplugged from the AC outlet.

## VOLUME CONTROL

- Do not turn up the volume while listening to a portion with very low level input or no audio signal. The speaker may be damaged when a peak level portion is played.

## CLEANING

- Clean only with a dry or slightly damp cloth. Do not use any cleansing agents or solvents. Unplug the product from the wall outlet before cleaning.

## SERVICE

- Do not open the cabinet of any components. There are no user-serviceable components in the product. Opening the cabinets may present a shock hazard, and any modification to the product will void your warranty.
- Do not attempt to service the unit yourself. If water or any metal objects such as paper clips, wire or staples accidentally fall inside, disconnect the unit from the power source immediately and consult an authorized service center.

## SAVE THESE INSTRUCTIONS

Thank you for purchasing your Airfonix™ dual band Smart Channel™ wireless system. Airfonix professional wireless audio products offer the flexibility to arrange your wireless audio system to suit your current needs. You can easily expand your system by adding models to accommodate specific venues or location requirements. Use a combination of at least two of these products (one **T Series** wireless transmitter with one **R Series** wireless receiver) to create the perfect wireless solution.

This manual covers the features, setup, and use for the following models:

#### Airfonix R Series

**AFX-19AR050:** Dual Band, two-channel wireless 50W mono/25+25W stereo receiver for **passive speakers**.

**AFX-19PR001:** Dual Band, two-channel wireless receiver for **active speakers**.

**NOTE:** **Active speakers** have built in amplifiers, while **passive speakers** do not have built in amplifiers.

#### Airfonix T Series

**AFX-19PT002:** Dual Band, two-channel wireless transmitter with dual balanced and SPDIF input jacks.

**AFX-19PT102:** Dual Band, two-channel wireless transmitter with high-level and SPDIF input jacks.

In addition to this manual, you will find a Quick Start Guide for each component you have purchased. Although these products are designed for easy operation, before you start we suggest you take the time to review these manuals to fully understand and take advantage of all the features in this system.

### About Airfonix Wireless

Airfonix redefines wireless audio with the industry's most advanced products for the professional and semi-pro audio markets. The products deliver uncompressed, 24-bit HDTV-compliant audio at 48 KHz sampling rate and are designed to retrofit any active or passive speaker, thereby bringing the freedom of wireless capability to any wired audio system.

Airfonix products boast Smart Channel capability, a patent-pending technology developed by SST that automatically searches for and selects an uncongested channel from both the 2.4 GHz and 4.9-5.8 GHz ISM bands. Because of this unique dual-band operation and Smart Channel capability, Airfonix products are virtually impervious to interference from co-located wireless equipment. The result is clean, true HDTV audio delivered wirelessly with the industry's most sophisticated transmission system developed especially for the stringent demands of professional users.

### Creating Your Airfonix Wireless System

Every wireless system consists of at least two components—a transmitter and a receiver, both of which must be paired and tuned to the same channel. Select the **T Series** transmitter that suits your audio source input preferences, either model **AFX-19PT002** or **AFX-19PT102**. You may connect two different audio sources to each of these models and switch between them by remote control or by using the button on the top of the unit.

The Airfonix **R Series** receivers are designed to retrofit any active or passive speaker, bringing the freedom of wireless capability to any wired audio system. If your venue is large, with the speakers placed far apart, dock a receiver to each speaker.

The **R Series** receivers can be mounted to your speakers with the included hardware or sit vertically using the stands. If your speakers are close together, select either **R Series** model **AFX-19PR001** for active (powered) speakers or **R Series** model **AFX-19AR050** for passive speakers. If your speakers are placed farther apart, use one **R Series** receiver for each speaker.

All units will be secure when you properly pair your transmitter with your receivers. You may use two receivers with each transmitter and setup different channels for up to four wireless systems within a 150 foot range.

The system will accommodate 4 to 8 ohms output. Any system with 70V will not work with these products.

# Table of Contents

Important Safety Instructions . . . . .	2
About Airfonix Wireless . . . . .	3
Creating Your Airfonix Wireless System . . . . .	3
Introduction . . . . .	3
Table of Contents . . . . .	4
Unpacking . . . . .	5
Tools Necessary . . . . .	5
Overview <b>AFX-19AR050</b> Receiver . . . . .	6
Overview <b>AFX-19PR001</b> Receiver . . . . .	7
Overview <b>AFX-19PT002</b> Transmitter . . . . .	8
Overview <b>AFX-19PT102</b> Transmitter . . . . .	9
Planning Your Installation . . . . .	10-12
Scenario 1: One Transmitter with One <b>AFX-19AR050</b> Passive Receiver, One Zone Stereo . . . . .	10
Scenario 2: One Transmitter with Two <b>AFX-19AR050</b> Passive Receivers, Two Zones Mono . . . . .	10
Scenario 3: One Transmitter with Two <b>AFX-19AR050</b> Passive Receivers, Two Zones Stereo . . . . .	11
Scenario 4: One Transmitter with One <b>AFX-19PR001</b> Active Receiver, One Zone Stereo . . . . .	11
Scenario 5: One Transmitter with Two <b>AFX-19PR001</b> Active Receivers, Two Zones Mono . . . . .	12
Scenario 6: One Transmitter with Two <b>AFX-19PR001</b> Active Receivers, Two Zones Stereo . . . . .	12
Before You Begin . . . . .	13-14
Pairing Transmitters and Receivers: Setup Sequence . . . . .	13
Setting Zone Codes for Your Installation . . . . .	14
Placement and Mounting Options . . . . .	15
Mounting to Speakers or Walls . . . . .	15
Using the Stands . . . . .	15
Preparing Components for Use . . . . .	16
Install External Antenna . . . . .	16
Preparing for Outdoor Use . . . . .	16
Connecting the Receivers . . . . .	17-20
Scenario 1: Connect One <b>AFX-19AR050</b> Active Receiver to 4 ohm, 25W One Zone, Stereo . . . . .	17
Scenario 1: Connect One <b>AFX-19AR050</b> Active Receiver to 8 ohm, 25W One Zone, Stereo . . . . .	17
Scenario 2: Connect Two <b>AFX-19AR050</b> Active Receivers to 4 ohm, 50W One Zone, Mono . . . . .	17
Scenario 2: Connect Two <b>AFX-19AR050</b> Active Receivers to 8 ohm, 36W One Zone, Mono . . . . .	18
Scenario 3: Connect Two <b>AFX-19AR050</b> Active Receivers to 4 ohm, 25W Two Zones, Stereo . . . . .	18
Scenario 3: Connect Two <b>AFX-19AR050</b> Active Receivers to 8 ohm, 36W Two Zones, Stereo . . . . .	18
Scenario 4: Connect One <b>AFX-19PR001</b> Passive Receiver to Active Speakers, One Zone, Stereo . . . . .	19
Using RCA Cables . . . . .	19
Using XLR Cables . . . . .	19
Scenario 5: Connect Two <b>AFX-19PR001</b> Passive Receivers to Active Speakers, Two Zones, Mono . . . . .	19
Using RCA Cables . . . . .	19
Using XLR Cables . . . . .	20
Scenario 6: Connect Two <b>AFX-19PR001</b> Passive Receivers to Active Speakers, Two Zones, Stereo . . . . .	20
Connecting the Transmitter . . . . .	20-21
Connecting Transmitter to One Source . . . . .	21
Connecting Transmitter to Two Sources . . . . .	21
Operation . . . . .	22
Using the Remote . . . . .	22
Using the IR Extender . . . . .	22
Troubleshooting Guide . . . . .	23
Regulation Information . . . . .	25
R Series Specifications . . . . .	26
T Series Specifications . . . . .	27

# Unpacking

Please check to make sure the following accessories are included in each package for:

## T Series models AFX-19PT002 or AFX-19PT102 Wireless Transmitters

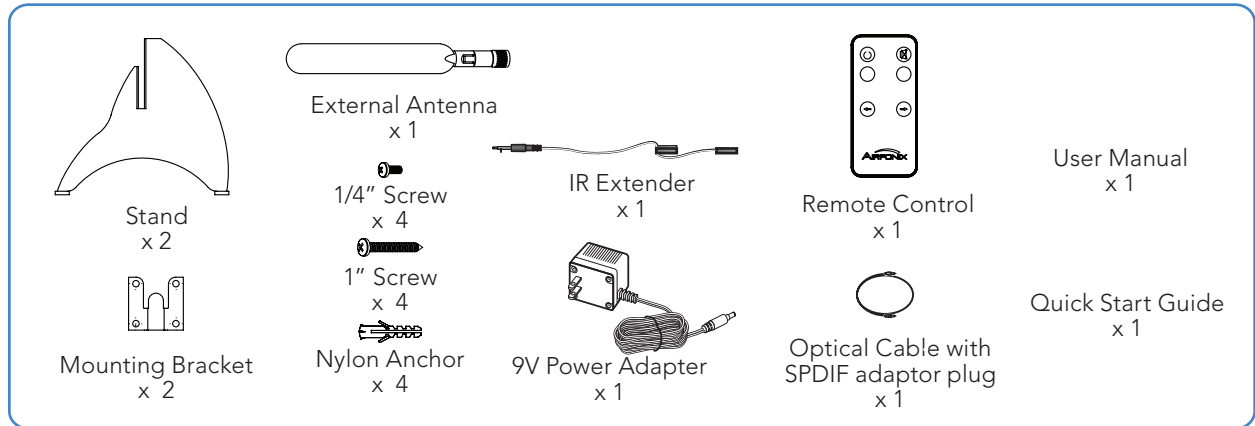

## R Series models AFX-19AR050 or AFX-19PR001 Wireless Receivers

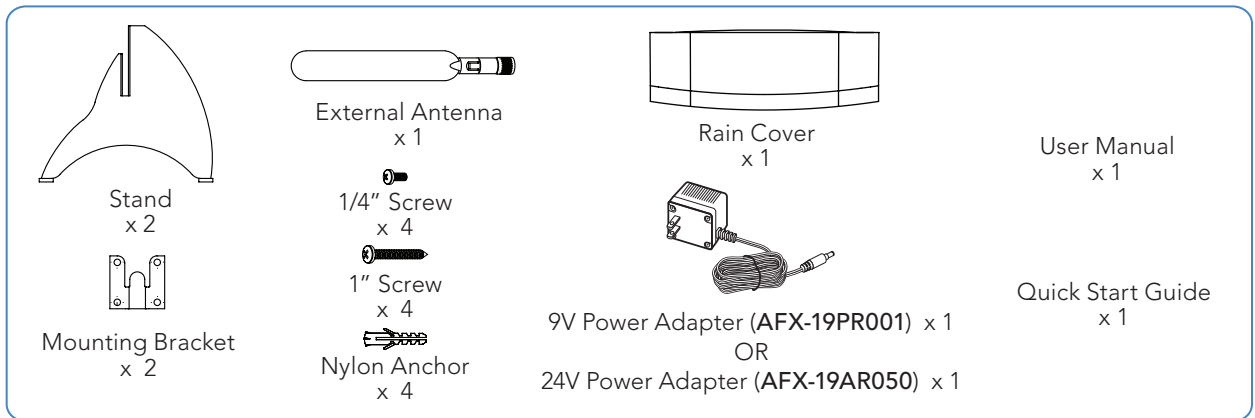

**IMPORTANT:** If you suspect transit damage or if anything is missing please contact Customer Service at (888) 778-2446 or [www.airfonix.com](http://www.airfonix.com) immediately. Keep the shipping cartons and materials.

## Tools Necessary



Very Small Flat Screwdriver  
(similar to an eyeglass screwdriver)



Phillips Screwdriver



Pencil



Tape Measure

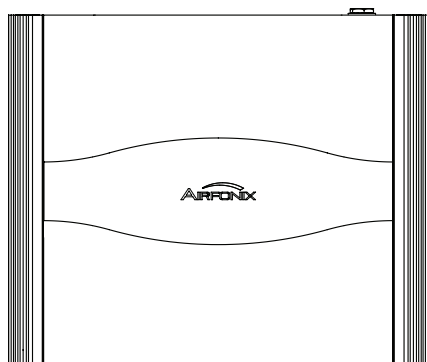

R Series model AFX-19AR050

Top

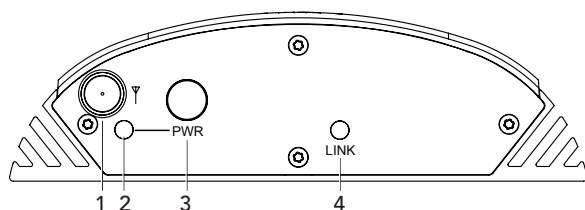

Bottom

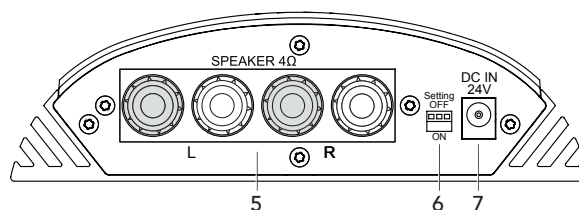

- 1 **ANTENNA:** Included external antenna attaches into this SMA jack.
- 2 **PWR LED:** Lights green when linked and red in standby mode. Lights orange in pairing mode (see page 13).
- 3 **PWR BUTTON:** Press to switch from standby to OFF. When in standby mode, the unit will power ON when linked to a transmitter.
- 4 **LINK LED:** Lights green when units are linked.
- 5 **SPEAKER 4Ω L and R:** Output connections 5-way binding posts use speaker cables to connect to passive speakers. NOTE: For use with 8 ohm speakers see Setting Zone Codes on page 14.
- 6 **Setting OFF/ON:** Used to pair units and set zone codes. See pages 12 and 13 for more information.
- 7 **DC IN 24V:** Used to connect supplied 24V AC adapter to an AC power source.

**NOTE:** When connecting one receiver to one speaker the output will be 50W per channel. When connecting both speakers it will be 25W per channel. See Setting Zone Codes on page 14.

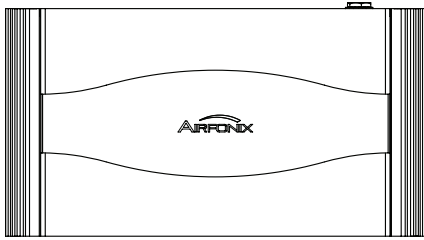

## R Series model AFX-19PR001

Top

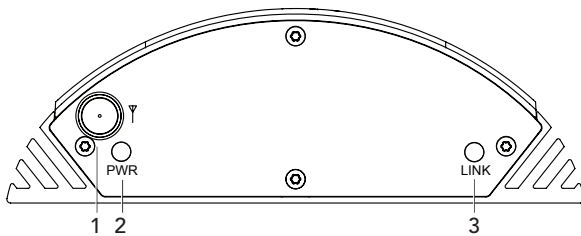

Bottom

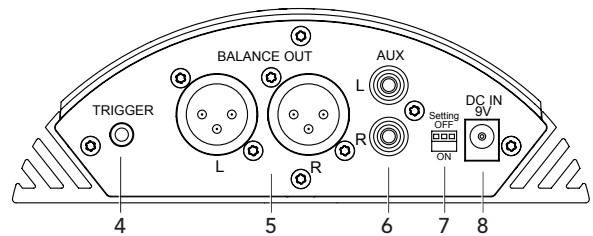

- 1 **ANTENNA:** Included external antenna attaches into this SMA jack.
- 2 **PWR LED:** Lights green when linked on and red in standby mode. Lights orange in pairing mode (see page 13).
- 3 **LINK LED:** Lights green when units are linked.
- 4 **TRIGGER JACK:** Passes a low voltage (9V with 1K ohm series resistance) control signal to the trigger input jack of connected power amplifier. Connects using cable with a mini-phone plug.
- 5 **BALANCE OUT L and R:** VAR level audio outputs for balanced left and right XLR-3M socket.
- 6 **AUX L and R:** Analog output for left and right RCA jacks.
- 7 **Setting OFF/ON:** Used to pair units and set zone codes. See pages 12 and 13 for more information.
- 8 **DC IN 9V:** Used to connect supplied 9V AC adapter to an AC power source.



**IMPORTANT:** To prevent signals mixing together, do not connect source to both the AUX L and R RCA jacks and the BALANCE IN sockets simultaneously.

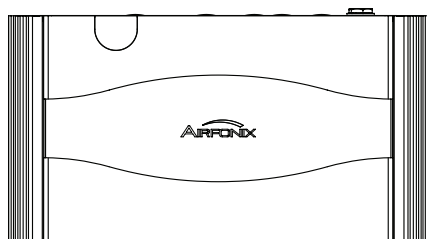

### T Series model AFX-19PT002

Top

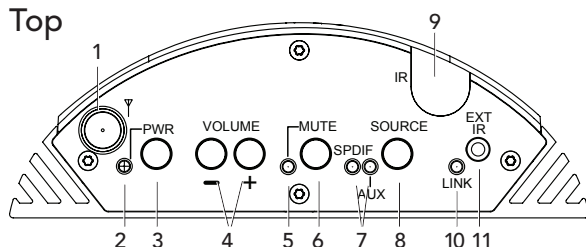

Bottom

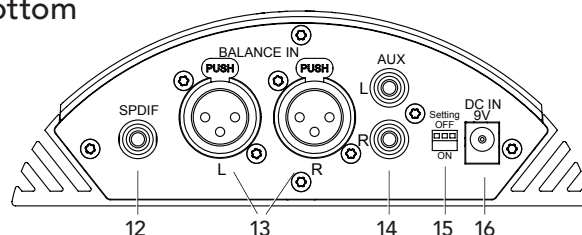

- 1 **ANTENNA:** Included external antenna attaches into this SMA jack.
- 2 **PWR LED:** Lights green when powered on and red in standby mode.
- 3 **PWR BUTTON:** Press to switch between standby mode and to power ON.
- 4 **VOLUME + and VOLUME – BUTTONS:** Press to increase or decrease volume.
- 5 **MUTE LED:** Lights red when mute mode is on.
- 6 **MUTE BUTTON:** Press to mute or unmute audio.
- 7 **SPDIF and AUX LED:** SPDIF LED lights green when audio source connected to SPDIF input source is powered on and selected. AUX LED lights green when audio source connected to the left and right RCA inputs marked AUX input OR the Balance In inputs and is powered on and selected.
- 8 **SOURCE BUTTON:** Press to switch between SPDIF and AUX sources.
- 9 **IR SENSOR:** Receives infrared signal from remote control.
- 10 **LINK LED:** Lights green when units are linked. Blinks green while sending pairing signals (see page 13).
- 11 **EXT IR:** Connects included IR extender.
- 12 **SPDIF:** Use supplied optical cable or (coaxial cable not included) to connect this digital input jack with optical or digital output in your HDTV.
- 13 **BALANCE IN L and R:** Connects to an audio source using XLR audio cables.
- 14 **AUX L and R:** Connects to an analog audio source using RCA cables.
- 15 **Setting OFF/ON:** Used to pair units and set zone codes. See pages 12 and 13 for more information.
- 16 **DC IN 9V:** Used to connect supplied 9V AC adapter to an AC power source.



#### IMPORTANT:

- To prevent signals mixing together, do not connect source to both the AUX L and R RCA jacks and the BALANCE IN sockets simultaneously.
- When connecting an audio source using the SPDIF input, it must use either 44.1KHz or 48KHz sampling rates. Check the owner's manual for your audio source if you are unsure.



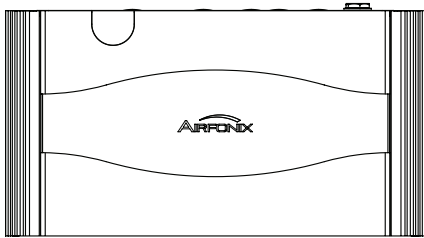

## T Series model AFX-19PT102

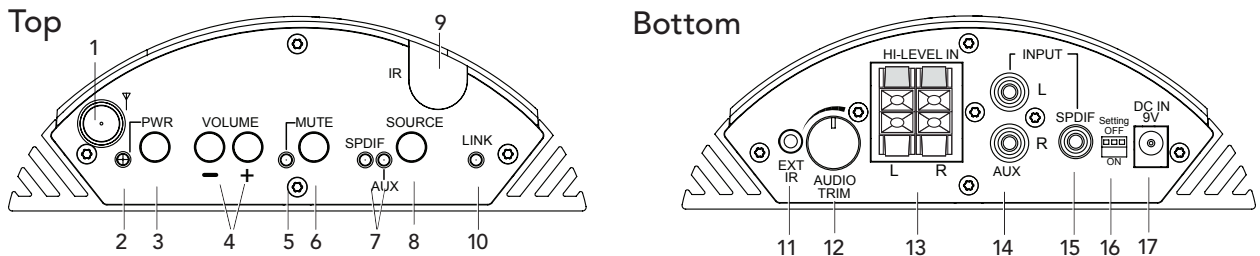

- 1 **ANTENNA:** Included external antenna attaches into this SMA jack.
- 2 **PWR LED:** Lights green when powered on and red in standby mode.
- 3 **PWR BUTTON:** Press to switch between standby mode and to power ON.
- 4 **VOLUME + and VOLUME – BUTTONS:** Press to increase or decrease volume.
- 5 **MUTE LED:** Lights red when mute mode is on.
- 6 **MUTE Button:** Press to mute or unmute audio.
- 7 **SPDIF and AUX LED:** SPDIF LED lights green when audio source connected to SPDIF input source is powered on and selected. AUX LED lights green when audio source connected to the Hi-Level In inputs OR the left and right RCA inputs marked AUX input is powered on and selected.
- 8 **SOURCE BUTTON:** Press to switch between SPDIF and AUX sources.
- 9 **IR SENSOR:** Receives infrared signal from remote control.
- 10 **LINK LED:** Lights green when units are linked. Blinks green while sending pairing signals (see page 13).
- 11 **EXT IR:** Connects included IR extender.
- 12 **AUDIO TRIM:** Dial turns to adjust input signal levels of audio sources connected to AUX and HI-LEVEL IN. NOTE: Make sure the audio trim is set to its lowest position before powering up.
- 13 **HI-LEVEL IN:** Connects to an audio source using speaker cables.
- 14 **AUX L and R:** Connects to an analog audio source using RCA cables.
- 15 **SPDIF:** Use supplied optical cable or (coaxial cable not included) to connect this digital input jack with optical or digital output in your HDTV.
- 16 **Setting OFF/ON:** Used to pair units and set zone codes. See pages 12 and 13 for more information.
- 17 **DC IN 9V:** Used to connect supplied 9V AC adapter to an AC power source.



### IMPORTANT:

- To prevent signals mixing together, do not connect source to both the AUX L and R RCA jacks and the HI-LEVEL IN sockets simultaneously.
- When connecting an audio source using the SPDIF input, it must use either 44.1KHz or 48KHz sampling rates. Check the owner's manual for your audio source if you are unsure.

# Planning Your Installation

The following examples will illustrate the versatility of the Airfonix wireless system. These illustrations are designed to demonstrate some of the many installations possible.

Since all receivers are lightweight, compact and designed with a rugged, weatherized industrial chassis for outdoor use, you can easily move the components from indoor to outdoor sites and reconfigure them for different venues or situations.

The **R Series** receivers include weather shields to further protect your components. All models can be easily mounted to speakers or walls with the included mounting hardware, rest on a flat surface such as a rack mount or stand vertically using the included stands.

Each **T Series** transmitter has two channels, allowing you to connect two audio sources and switch back and forth with the included remote control. Most of the illustrations show this option, however in many situations you will only use one source.

Possible Audio Sources include stereo receivers, DVD players, CD players, digital TVs, professional mixing consoles, gaming products, computers, iPods, MP3s or any product with a speaker output connection.

## Scenario 1: One Transmitter with One AFX-19AR050 Passive Receiver, One Zone Stereo

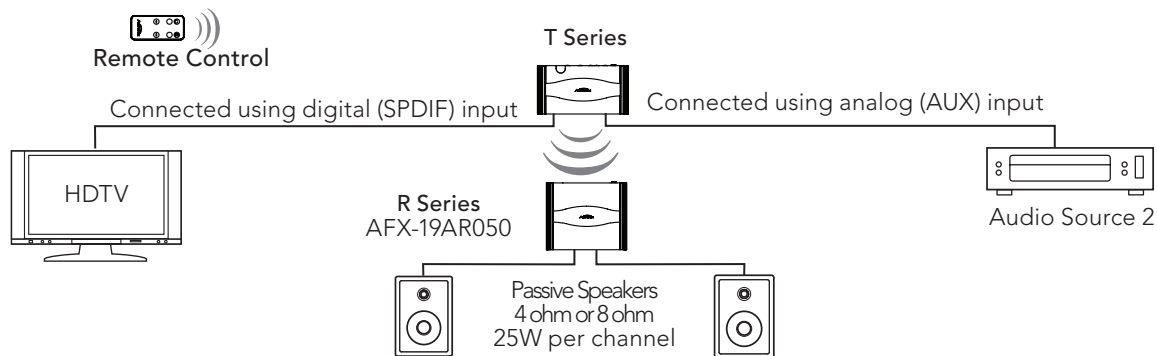

## Scenario 2: One Transmitter with Two AFX-19AR050 Passive Receivers, Two Zones Mono

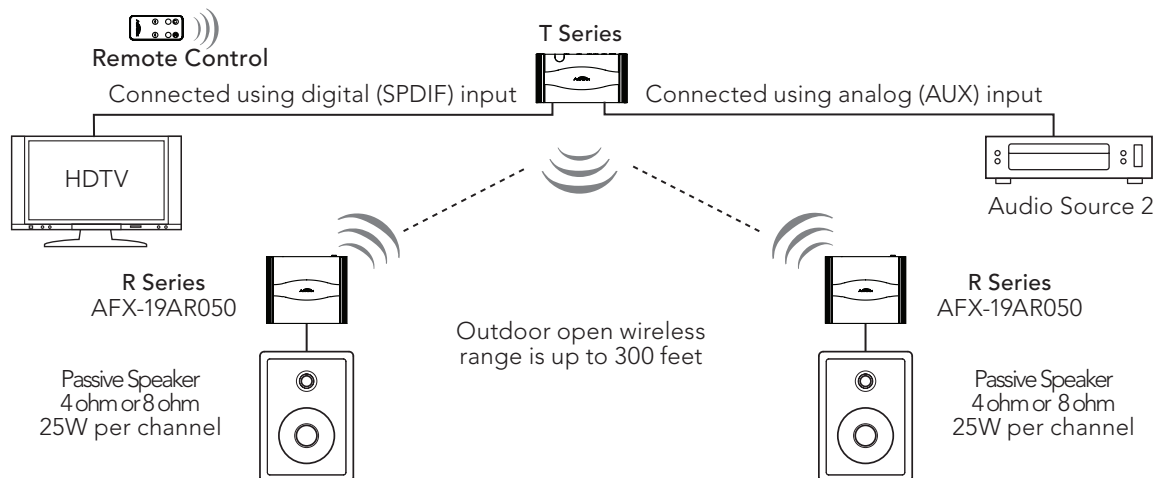

**IMPORTANT:** The analog (AUX) inputs include Hi-Level In, Balance In and L and R RCA jack inputs. **Connect your audio source to ONLY one of these inputs.**

# Planning Your Installation

## Scenario 3: One Transmitter with Two AFX-19AR050 Passive Receivers, Two Zones Stereo

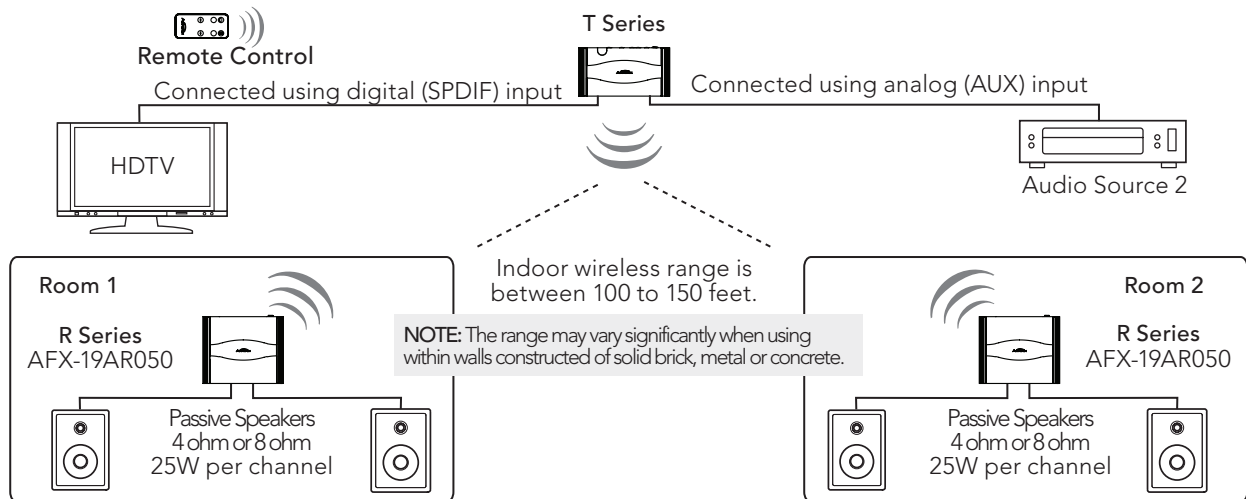

### NOTES:

- The R Series receivers and T Series transmitters conveniently dock and undock to speakers or walls using the included mounting brackets.
- You may pair a maximum of two receivers to each transmitter and use three sets of transmitters within a 150 foot range without conflict.
- Rain shield covers are included with each receiver for protection in outdoor installations.

## Scenario 4: One Transmitter with One AFX-19PR001 Active Receiver, One Zone Stereo

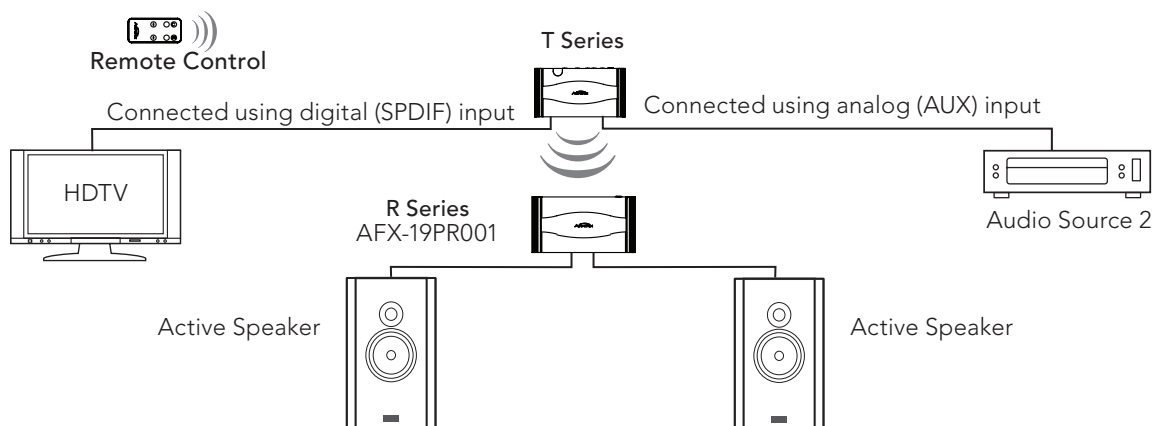

**IMPORTANT:** The analog (AUX) inputs include Hi-Level In, Balance In and L and R RCA jack inputs. **Connect your audio source to ONLY one of these inputs.**

# Planning Your Installation

## Scenario 5: One Transmitter with Two AFX-19PR001 Active Receivers, Two Zones Mono

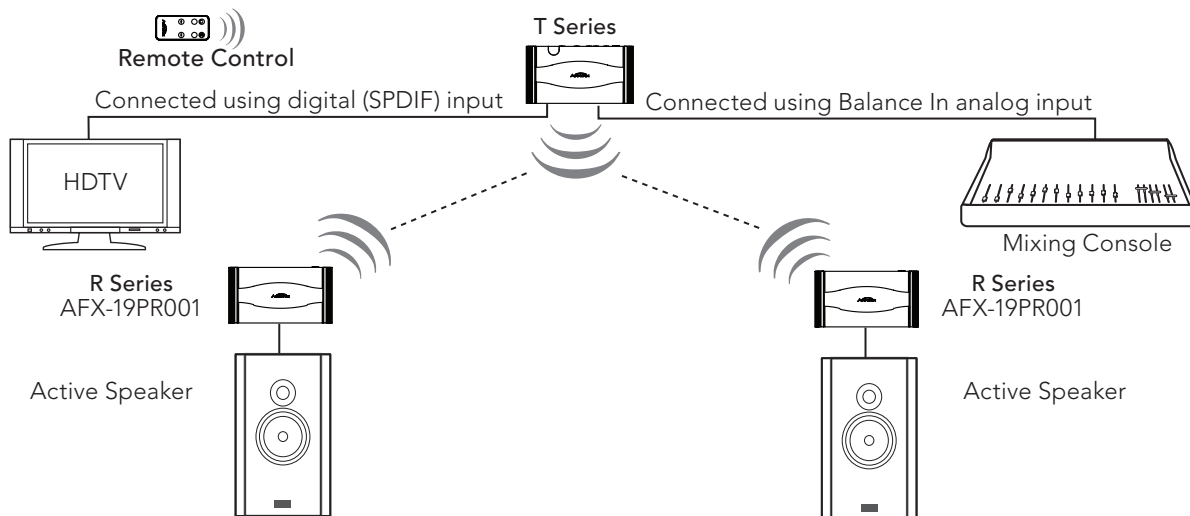

## Scenario 6: One Transmitter with Two AFX-19PR001 Active Receivers, Two Zones Stereo

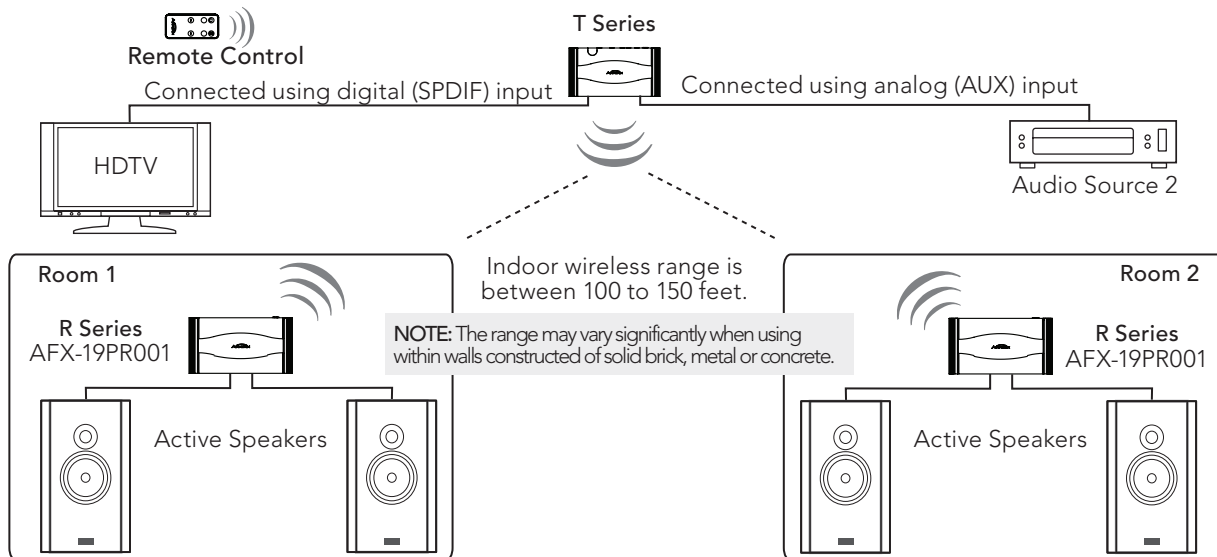

**IMPORTANT:** The analog (AUX) inputs include Hi-Level In, Balance In and L and R RCA jack inputs. **Connect your audio source to ONLY one of these inputs.**

### NOTES:

- The R Series receivers and T Series transmitters conveniently dock and undock to speakers or walls using the included mounting brackets.
- You may pair a maximum of two receivers to each transmitter and use three sets of transmitters within a 150 foot range without conflict.
- Rain shield covers are included with each receiver for protection in outdoor installations.

## Pairing Transmitters and Receivers: Setup Sequence

**IMPORTANT:** Before you begin, follow the sequence of six steps to PAIR each of the receivers with the transmitter in your installation. You may pair one transmitter with up to two receivers. You will need the remote control and a small screwdriver for these steps.

### Step 1

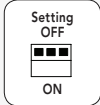
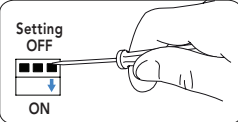
<p><b>Transmitter</b></p>  <p>Setting OFF ON</p> <p>For transmitter: All dip switches must be in OFF position.</p>	<p><b>Receiver(s)</b></p>  <p>Setting OFF ON</p> <p>For all receivers: Push the third dip switch to ON position to enter pairing mode.</p>
---	---

### Step 2

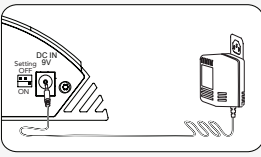
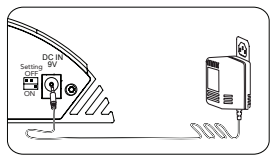
<p><b>Transmitter</b></p> 	<p><b>Receiver(s)</b></p> 
<p>Connect the power for all units.</p>	

### Step 3

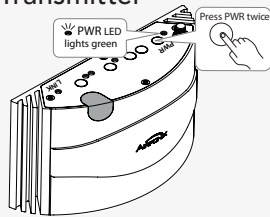
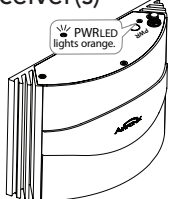
<p><b>Transmitter</b></p>  <p>Press PWR twice</p> <p>PWR LED lights green</p> <p>Press the PWR button on transmitter to power ON.</p>	<p><b>Receiver(s)</b></p>  <p>PWRLED lights orange.</p> <p>Receivers are in pairing mode. PWR LED lights orange.</p>
--	---

**IMPORTANT:** Complete steps 3 and 4 within 10 seconds. Watch the LINK LEDs to make sure the pairing is successful.

### Step 4

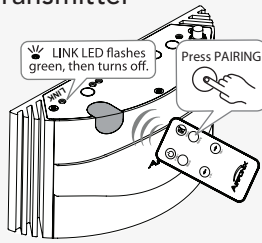
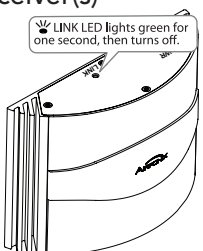
<p><b>Transmitter</b></p>  <p>LINK LED flashes green, then turns off.</p> <p>Press PAIRING</p>	<p><b>Receiver(s)</b></p>  <p>LINK LED lights green for one second, then turns off.</p>
<p>With the remote pointing at the <b>transmitter</b>, press the <b>PAIRING</b> button. Watch the <b>LINK</b> LEDs.</p> <ul style="list-style-type: none"> <li>• The <b>transmitter</b> LINK LED flashes for three seconds and then turns OFF.</li> <li>• The <b>receiver(s)</b> LINK LED light for one second and then turn OFF.</li> </ul>	

### Step 5

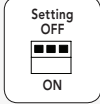
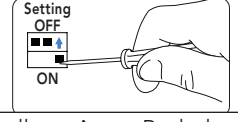
<p><b>Transmitter</b></p>  <p>Setting OFF ON</p> <p>For transmitter: All dip switches must be in OFF position.</p>	<p><b>Receiver(s)</b></p>  <p>Setting OFF ON</p> <p>For all receivers: Push the third dip switch to OFF position to exit pairing mode.</p>
---	---

### Step 6

The ID code has now been copied to each of the units and they are paired together. Follow the instructions for Setting Zone Codes for your installation on page 14 to complete setup.

**NOTE:** The LINK LEDs on all paired units will light green AFTER you have set the zone codes and all units are powered ON again.

# Before You Begin

## Setting Zone Codes for Your Installation

The Airfonix **R** and **T Series** are highly versatile. The six scenarios illustrated on pages 10 through 12 require corresponding zone codes that you will now set. If you have any questions please contact Customer Service at (888) 778-2446 or [www.airfonix.com](http://www.airfonix.com).

First go through the bulleted list to determine if you are using:

- One or Two Receivers.
- Active or Passive Speakers. **NOTE:** Follow the black heading for passive and the blue heading for active speakers on the chart below.
- One or Two Zones.
- Power of Each Connected Speaker. **NOTE:** Scenarios 1 through 3 use different codes for setup with 4 ohm or 8 ohm speakers.
- LEFT Mono, RIGHT Mono, or Stereo Channels.

Use the charts below to determine the correct settings for each unit:

<b>1 Transmitter/1 Receiver 1 ZONE</b> Scenario 1 (4 ohm)		<b>1 Transmitter/2 Receivers 1 ZONE</b> Scenario 2 (4 ohm)			<b>1 Transmitter/2 Receivers 2 ZONES</b> Scenario 3 (4 ohm)		
<b>Transmitter</b>  Setting OFF  ON	<b>Receiver Stereo</b> 4 ohm, 25W/ch  Setting OFF  ON	<b>Transmitter</b>  Setting OFF  ON	<b>Receiver Mono LEFT</b> 4 ohm, 50W  Setting OFF  ON	<b>Receiver Mono RIGHT</b> 4 ohm, 50W  Setting OFF  ON	<b>Transmitter</b>  Setting OFF  ON	<b>Receiver Stereo</b> 4 ohm, 25W/ch  Setting OFF  ON	<b>Receiver Stereo</b> 4 ohm, 25W/ch  Setting OFF  ON
<b>1 Transmitter/1 Receiver 1 ZONE</b> Scenario 1 (8 ohm)		<b>1 Transmitter/2 Receivers 1 ZONE</b> Scenario 2 (8 ohm)			<b>1 Transmitter/2 Receivers 2 ZONES</b> Scenario 3 (8 ohm)		
<b>Transmitter</b>  Setting OFF  ON	<b>Receiver Stereo</b> 8 ohm, 25W/ch  Setting OFF  ON	<b>Transmitter</b>  Setting OFF  ON	<b>Receiver mono LEFT</b> 8 ohm, 36W  Setting OFF  ON	<b>Receiver mono RIGHT</b> 8 ohm, 36W  Setting OFF  ON	<b>Transmitter</b>  Setting OFF  ON	<b>Receiver Stereo</b> 8 ohm, 25W/ch  Setting OFF  ON	<b>Receiver Stereo</b> 8 ohm, 25W/ch  Setting OFF  ON
<b>1 Transmitter/1 Receiver 1 ZONE</b> Scenario 4		<b>1 Transmitter/2 Receivers 1 ZONE</b> Scenario 5			<b>1 Transmitter/2 Receivers 2 ZONES</b> Scenario 6		
<b>Transmitter</b>  Setting OFF  ON	<b>Receiver Stereo</b> Active Speakers  Setting OFF  ON	<b>Transmitter</b>  Setting OFF  ON	<b>Receiver Mono LEFT</b> Active Speakers  Setting OFF  ON	<b>Receiver Mono RIGHT</b> Active Speakers  Setting OFF  ON	<b>Transmitter</b>  Setting OFF  ON	<b>Receiver Stereo</b> Active Speakers  Setting OFF  ON	<b>Receiver Stereo</b> Active Speakers  Setting OFF  ON

Use a small screwdriver to set the correct codes for each unit:

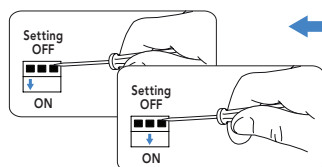

Disconnect the power from all units. Locate the three dip switches on the bottom of each unit. Use a small flat screwdriver to push the first and second dip switches to ON or leave in OFF position to match the code for your installation.

**IMPORTANT:** Do not adjust the third dip switch. Leave it in the OFF position after pairing. The factory default position is OFF for all switches.

**IMPORTANT:** Pay close attention when making these connections. The receiver set with the left channel codes connects to your speaker using the left output connectors and the receiver set with the right channel codes connects to your speaker using the right output connectors. The system will not work unless these connections are correct.

# Placement and Mounting Options

These units are designed to easily adapt to any location. Either lay them on a flat surface or use the included accessories to stand or mount vertically.

## Mounting to Speakers or Walls

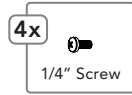
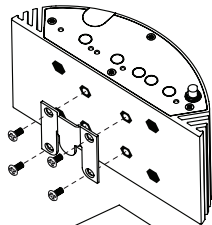

← Rest the unit face down and place one of the mounting brackets facing the bottom on the back of the unit. Line up holes in the bracket with holes in the unit. Use a Phillips screwdriver to secure bracket with four 1/4" included screws.

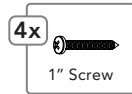
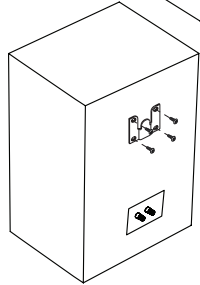

← Place the other bracket face up a 1/2" from desired placement position on wall or speaker. Using the bracket as a template, mark the holes with a pencil. If necessary, use a drill to drill holes and use a Phillips screwdriver to secure bracket with four 1" included screws.

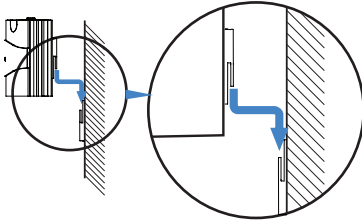

← Slide unit onto bracket attached to wall or speaker, making sure the top of the bracket fits into the bottom bracket.

**NOTE:** The mounting brackets are identical. One is installed facing down to interlock with the other.

## Using the Stands

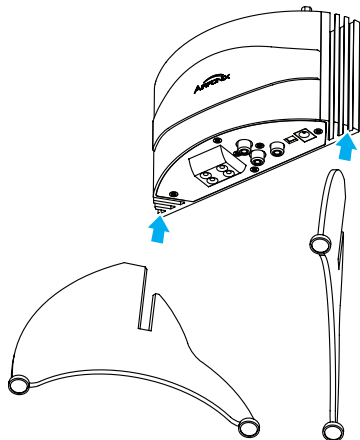

← Fit each of the two included stands into the outside slot on each side of the bottom of the unit.

The unit sits vertically on a flat surface.

**NOTE:** The stands are identical. One fits into the slots on the bottom left side of the unit and the other fits into the bottom right side.

## Preparing Components for Use

### Install External Antenna

- ← Connect the supplied external antenna to the SMA jack on the top of each unit and turn clockwise to screw into place.

The antenna folds down to a 90 degree angle and rotates 180 degrees at the base to adjust for better reception.

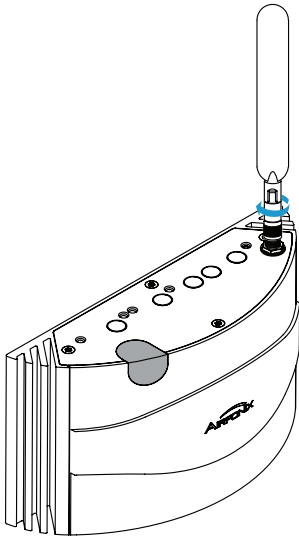

### Preparing for Outdoor Use

- ← The receivers are designed with a rugged, weatherized industrial chassis for outdoor use. In addition, we have included rain covers with each **R Series** receiver. These are designed to extend over the wires to protect them from direct contact with water.

Before connecting your speakers, turn the receiver upside down and fit the rain cover into the inside slots on each side. Slide it into place.

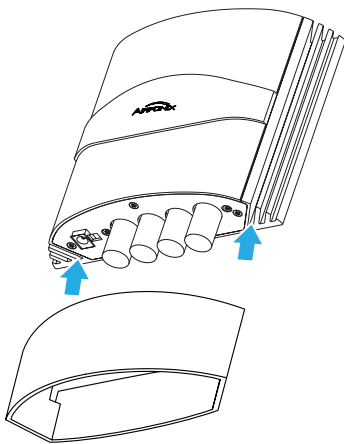

**NOTE:** The rain covers may also be used in indoor installations to conceal connections and create a cleaner look.



# Connecting the Receivers

You may use up to two Airfonix **R Series** wireless receivers with each **T Series** transmitter. This is useful when the speakers are spaced far apart. Follow the installation diagrams for the six scenarios. Make sure to set the correct zone codes for your installation.

**AFX-19AR050:** Designed for use with semi-pro or home audio equipment. Use speaker cables to connect either two passive speakers at 25W per channel or one passive speaker at 50W per channel with banana plug connectors.

**AFX-19PR001:** Designed for use with professional active speakers. Connect using XLR audio cables or RCA stereo audio jacks.

**! IMPORTANT:** Make sure all your equipment is unplugged from the power source and all volume, level and gain controls are lowered before making connections.

## Scenario 1:

Connect One AFX-19AR050 Passive Receiver to 4 ohm, 25W One Zone, Stereo

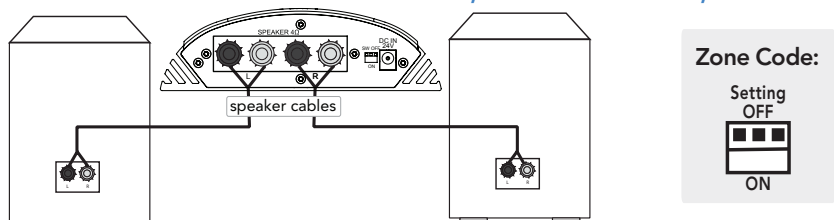

## Scenario 1:

Connect One AFX-19AR050 Passive Receiver to 8 ohm, 25W One Zone, Stereo

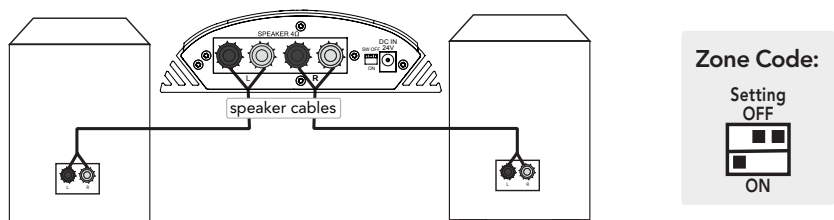

## Scenario 2:

Connect Two AFX-19AR050 Passive Receivers to 4 ohm, 50W One Zone, Mono

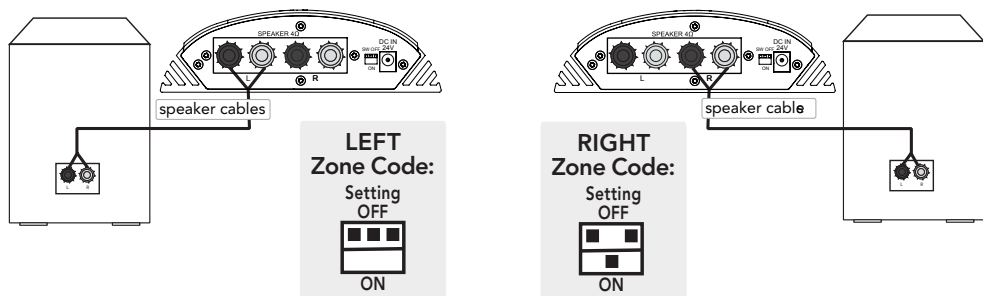

**! IMPORTANT:** Your system will not work properly unless the dip switches on each unit are set to the correct positions for your installation. See Setting Zone Codes on page 14 for more information.

# Connecting the Receivers

## Scenario 2: Connect Two AFX-19AR050 Active Receivers to 8 ohm, 36W One Zone, Mono

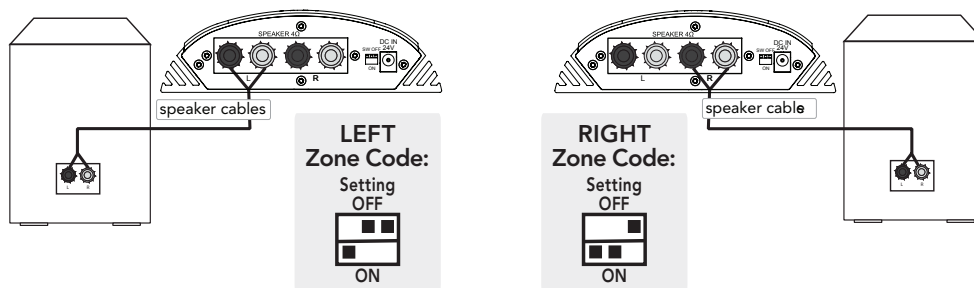

## Scenario 3: Connect Two AFX-19AR050 Active Receivers to 4 ohm, 25W Two Zones, Stereo

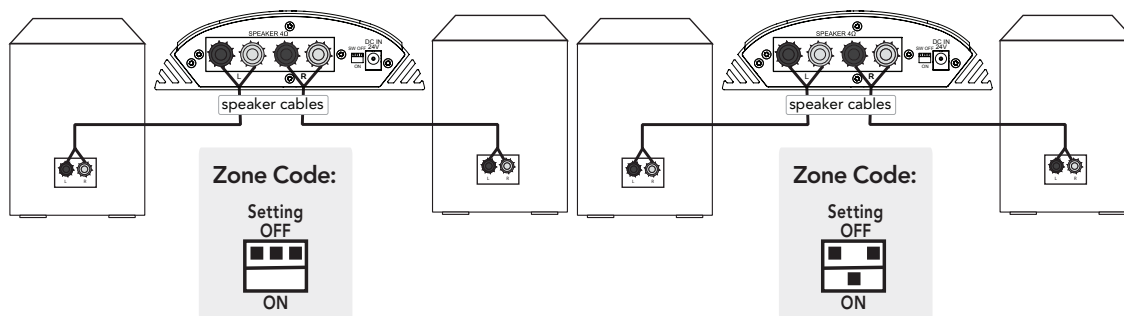

NOTE: The range may vary significantly with walls constructed of solid brick, metal or concrete.

## Scenario 3: Connect Two AFX-19AR050 Active Receivers to 8 ohm, 36W Two Zones, Stereo

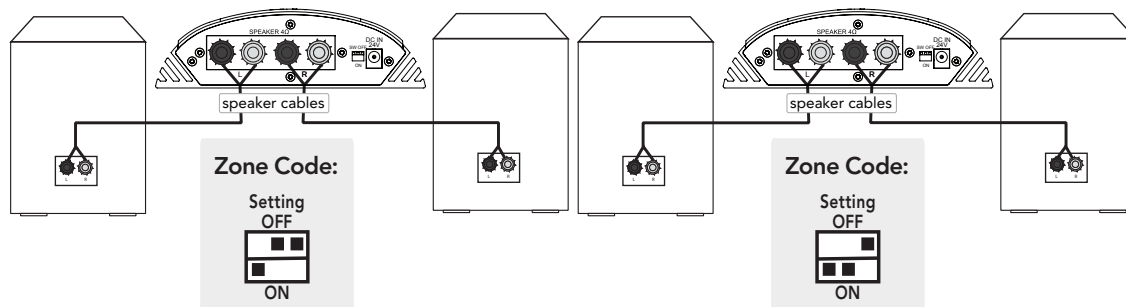

NOTE: The range may vary significantly with walls constructed of solid brick, metal or concrete.

**!** **IMPORTANT:** Your system will not work properly unless the dip switches on each unit are set to the correct positions for your installation. See Setting Zone Codes on page 14 for more information.

# Connecting the Receivers

## Scenario 4: Connect One AFX-19PR001 Passive Receiver to Active Speakers, One Zone, Stereo

### Using RCA Cables

OR

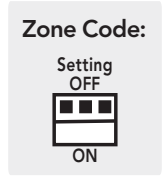
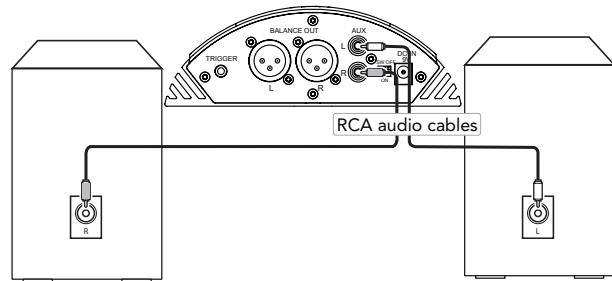

### Using XLR Cables

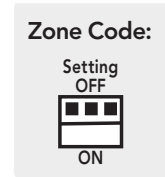
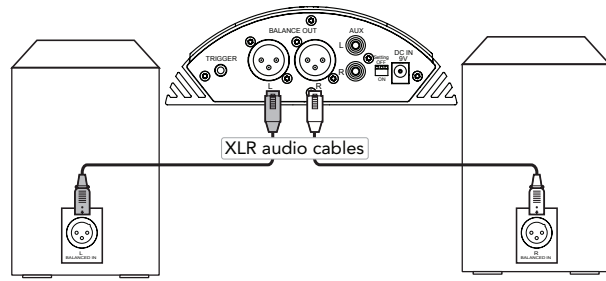

**NOTE:** Use either XLR or RCA audio cables when connecting speakers to one AFX-19PR001 receiver. Do not use both for the same installation.

## Scenario 5: Connect Two AFX-19PR001 Passive Receivers to Active Speakers, Two Zones, Mono

### Using RCA Cables

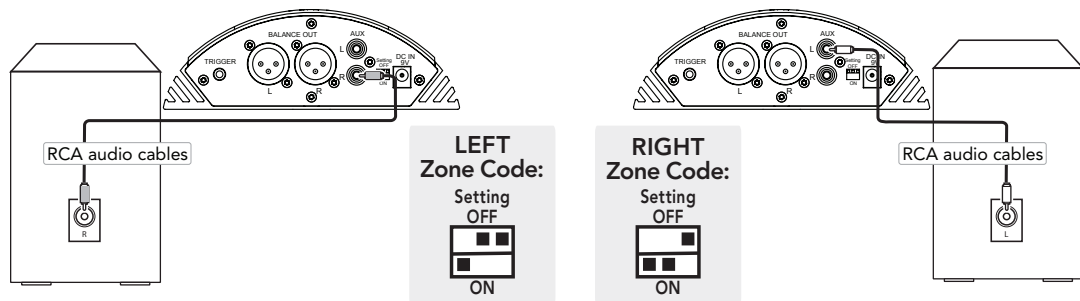

**! IMPORTANT:** Your system will not work properly unless the dip switches on each unit are set to the correct positions for your installation. See Setting Zone Codes on page 14 for more information.

## Connecting the Receivers

### Scenario 5: Connect Two AFX-19PR001 Passive Receivers to Active Speakers, Two Zones, Mono Using XLR Cables

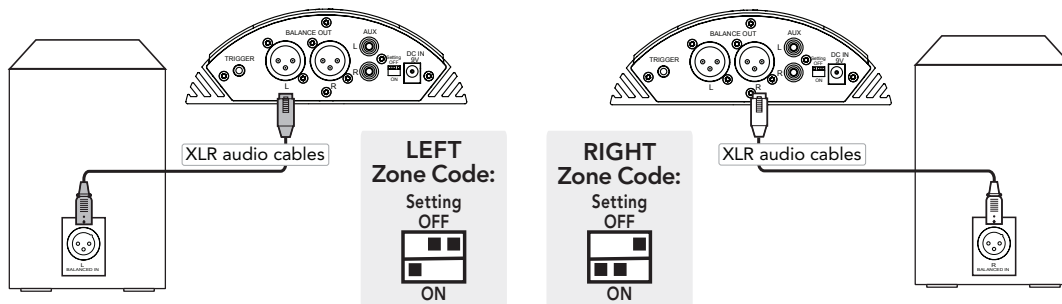

**NOTE:** Use either XLR or RCA audio cables. Do not use both for the same installation.

### Scenario 6: Connect Two AFX-19PR001 Passive Receivers to Active Speakers, Two Zones, Stereo

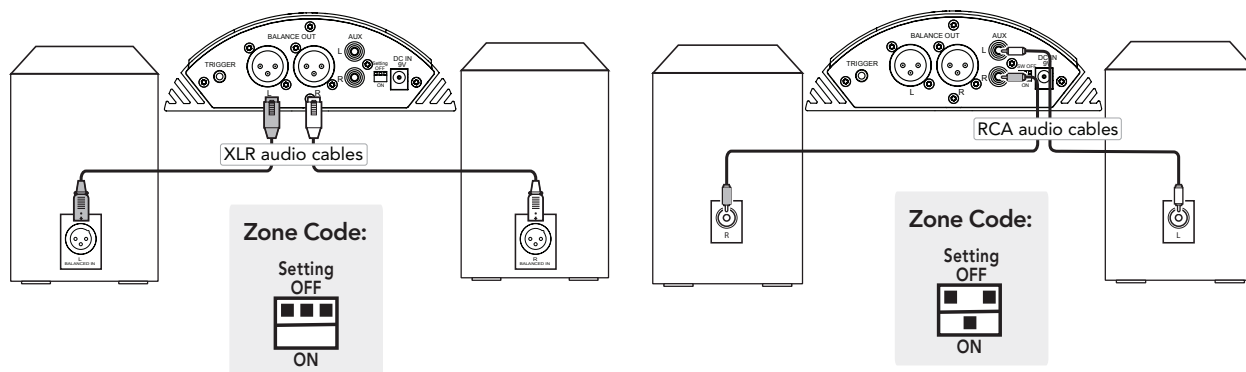

**IMPORTANT:** Your system will not work properly unless the dip switches on each unit are set to the correct positions for your installation. See Setting Zone Codes on page 14 for more information.

## Connecting the Transmitter

Airfonix **T Series** wireless transmitters may be connected to any audio product with a speaker output connection such as stereo receivers, digital TVs, DVD players, CD players, professional mixing consoles, gaming products, computers, iPods or MP3 players.

**AFX-19PT002:** Designed for use with professional audio equipment. Connect using XLR audio cables into Balance In, optical cable into digital SPDIF input jack or RCA stereo cable into RCA jacks.

**AFX-19PT102:** Designed for use with semi-pro or home audio equipment. Connect using speaker cables into Hi-Level IN push terminals, RCA stereo cable into RCA jacks or optical cable into digital SPDIF input jack.

## Connecting Transmitter to One Source

Unplug the power to the audio components before making any of these connections. Depending on the audio inputs on your audio source, select one of the following methods for connection:

AFX-19PT002

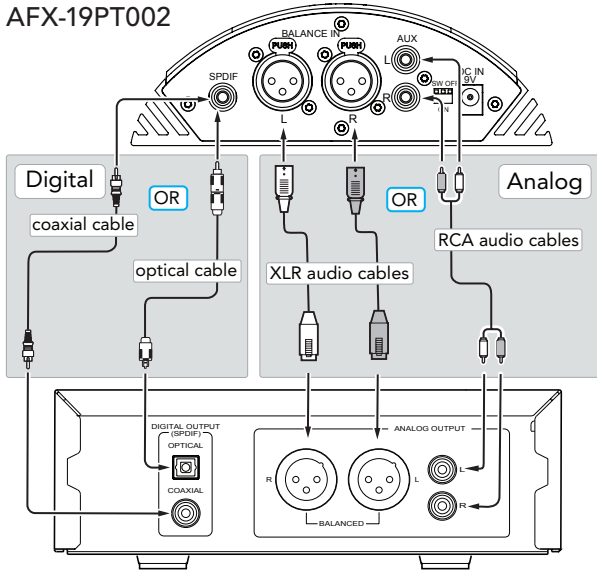

AFX-19PT102

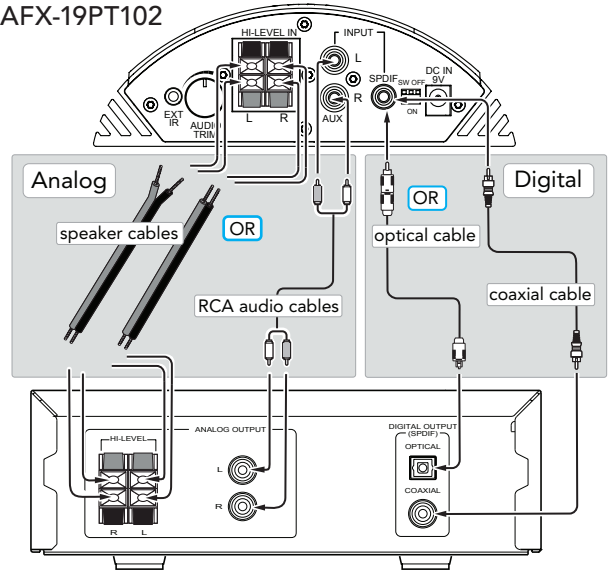

## Connecting Transmitter to Two Sources

Follow the directions above for connecting to one source to connect a second audio source to your transmitter.

**NOTE:** You may only switch between an audio source connected to one of the analog input sources (Hi-Level In, Balance In or RCA L and R inputs labeled AUX) and another audio source connected to the digital input source (SPDIF).

## Set the Zone Codes For Your Installation:

<p><b>One Transmitter with One Receiver One Zone Zone Code:</b></p> <p>Setting OFF</p> <p>ON</p>	OR	<p><b>One Transmitter with Two Receivers One Zone Zone Code:</b></p> <p>Setting OFF</p> <p>ON</p>	OR	<p><b>One Transmitter with Two Receivers Two Zones Zone Code:</b></p> <p>Setting OFF</p> <p>ON</p>
--	----	---	----	--

When you have finished, plug your transmitter and the audio sources into the AC outlet and turn them on. You may use one audio source at a time. Power on the desired audio source and press the POWER button on top of your T Series to power it on. Push the SOURCE button to switch between SPDIF (digital) and AUX (analog) sources. The corresponding green LED indicators light when each source is selected.

You may also use the remote control to power on and switch sources. See page 22.

**IMPORTANT:** Your system will not work properly unless the dip switches on each unit are set to the correct positions for your installation. See Setting Zone Codes on page 14 for more information.

# Operation

## Using the Remote

The remote is shipped with a thin plastic insert which prevents the battery from charging until ready for use. Firmly pull the plastic tab to remove insert and activate battery.

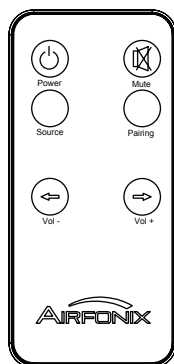

- ⏻ **Power Button:** Press to power your **T Series** ON or OFF.
- 🔇 **Mute Button:** Press to mute or unmute the audio.
- 🔊 **Source Button:** Press to switch between audio sources connected to the SPDIF (digital) or AUX (analog) input sources. NOTE: audio sources must be powered on.
- 🔗 **Pairing Button:** Use to pair **R Series** with **T Series**. See page 13.
- ➡ **Volume + Button:** Press to increase the volume by 1 decibel. Hold to continuously increase volume.
- ⬅ **Volume – Button:** Press to decrease the volume by 1 decibel. Hold to continuously decrease volume.

T Series

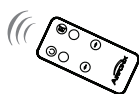
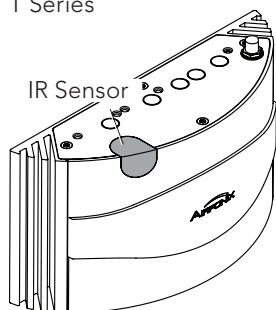

➡ To use, point the remote at the IR Sensor on the top of your **T Series** and press desired button. The remote will function properly up to 15 feet away and facing the IR sensor within a range of +/- 30 degrees.

## Using the IR Extender

The included IR extender allows you to hide your unit or put it inside a cabinet.

Plug the IR extender into mini-jack on the top of your **T Series** and position the IR sensor so it is in direct line of sight. The **T Series** remote will control volume levels and mute of your **T and R Series** and the components connected to them, even when all the units are not in line of sight.

# Troubleshooting Guide

If you're having trouble using the **R and T Series**, look for a solution here. Some issues may be caused by a connected component. Refer also to the manuals for your other components. If you can't resolve the issue yourself, contact Airfonix Customer Service at (888) 778-2446 or [www.airfonix.com](http://www.airfonix.com).



**IMPORTANT:** During normal operation the **LINK LED** lights green, the **POWER LED** lights green and either the **AUX LED** or the **SPDIF LED** lights green. Check the status of all the LEDs when using this Troubleshooting Guide to help you quickly solve your problem.

ISSUE	Check LED Status:	Go Through the Solutions:
The units do not power ON.	POWER LED is not lit:	<ul style="list-style-type: none"> <li>• Make sure the supplied AC adaptor is plugged securely into the DC IN jack on the bottom of the unit and into a working AC outlet.</li> <li>• Press the <b>POWER</b> button to turn the units on.</li> </ul>
	POWER LED is lit red:	<ul style="list-style-type: none"> <li>• Either the transmitter and/or the receiver is in standby mode. Press the <b>POWER</b> button on the transmitter to power ON. The <b>POWER LED</b> on the receivers light green when linked with the transmitter.</li> </ul>
No sound or faint sound.	<p>POWER LED is lit green:</p> <p>LINK LED is lit green:</p> <p>AUX LED is lit green:</p>	<ul style="list-style-type: none"> <li>• Make sure connected audio source is plugged into a working AC outlet, turned on, and working.</li> <li>• Make sure the correct source is selected on the transmitter. When the unit is powered on, it will default to AUX and the <b>AUX LED</b> lights green. Press the <b>SOURCE</b> button to switch to sources. The <b>SPDIF LED</b> lights green indicating the source connected using the digital SPDIF input is selected. The <b>AUX LED</b> lights green indicating the source connected using one of the analog sources is selected, either using the L and R RCA inputs (marked AUX) OR the Hi-Level In inputs OR the L and R Balance In inputs is selected.</li> </ul> <p><b>NOTE:</b> you may only switch between an audio source connected to one of the analog input sources (Hi-Level In, Balance In or AUX) and another audio source connected to the digital input source (SPDIF). See pages 18-19 for Connecting the Transmitter.</p> <ul style="list-style-type: none"> <li>• Check the volume level on your transmitter.</li> <li>• Check the speaker connections to the receivers. See pages 16-18 for Connecting the Receivers.</li> <li>• If the connected speakers are active, make sure they are plugged into a working AC outlet and powered on.</li> <li>• Make sure the codes are set correctly for your installation. See page 14 for Setting Zone Codes.</li> </ul>



**IMPORTANT:** During normal operation the **LINK** LED lights green, the **POWER** LED lights green and either the **AUX** LED or the **SPDIF** LED lights green. Check the status of all the LEDs when using this Troubleshooting Guide to help you quickly solve your problem.

ISSUE	Check LED Status:	Go Through the Solutions:
No sound or faint sound.	LINK LED is not lit:	<ul style="list-style-type: none"> <li>• Make sure all units are powered ON.</li> <li>• Move the transmitter closer to the receiver to check the link status. If the <b>LINK</b> LED lights solid green, then reorient the units or adjust the external antennas see page 16.</li> <li>• If the <b>LINK</b> LEDs are still not lit, go through the sequence of steps on page 13 for Pairing Transmitters and Receivers.</li> <li>• Make sure the zone codes are correctly set for your installation. See page 14.</li> <li>• Make sure your SPDIF input source is well connected with proper signal.</li> </ul>
	MUTE LED is lit red:	<ul style="list-style-type: none"> <li>• Press the <b>MUTE</b> button on your transmitter to unmute the volume.</li> </ul>
	SPDIF LED is lit green:	<ul style="list-style-type: none"> <li>• Make sure the connected audio source uses either a 44.1KHz or 48KHz.</li> </ul>
No sound from one speaker.	MUTE LED is not lit:	<ul style="list-style-type: none"> <li>• Make sure the speaker is correctly connected to the receiver.</li> </ul>
	LINK LED is lit green:	<ul style="list-style-type: none"> <li>• If it is an active speaker, make sure it is plugged into a working AC outlet and powered on.</li> </ul>
	AUX or SPDIF LED is lit green:	<ul style="list-style-type: none"> <li>• Check the speaker balance on your audio source.</li> <li>• Make sure the codes are set correctly for your installation. See page 14 for Setting Zone Codes.</li> </ul>
Distorted audio or unwanted noise.	POWER LED is lit green:	<ul style="list-style-type: none"> <li>• Make sure the audio from the source is not distorted.</li> </ul>
	LINK LED is lit green:	<ul style="list-style-type: none"> <li>• Make sure you have connected only one audio source to the analog inputs on your transmitter. See pages 20-21.</li> </ul>
	AUX or SPDIF LED is lit green:	<ul style="list-style-type: none"> <li>• If you are using AFX-19PT102, try adjusting the audio trim. See page 9.</li> <li>• Try reorienting the units. It is best to maintain a clear line of site between units.</li> </ul>
The remote control isn't working.	POWER LED is lit green:	<ul style="list-style-type: none"> <li>• Use the buttons on each unit to make sure the equipment is working properly.</li> </ul>
	LINK LED is lit green:	<ul style="list-style-type: none"> <li>• Make sure the third dip switch on the <b>transmitter</b> is in the OFF position. The remote will not function if it is in the ON position. See pages 13-14.</li> </ul>
	AUX or SPDIF LED is lit green:	<ul style="list-style-type: none"> <li>• Make sure the remote is in line of sight of the IR sensor on the transmitter. If not, attach the IR extender and adjust it so it is in direct line of sight. See page 22.</li> <li>• Change the battery.</li> </ul>



## Federal Communication Commission Interference Statement

This equipment has been tested and found to comply with the limits for a Class B digital device, pursuant to Part 15 of the FCC Rules. These limits are designed to provide reasonable protection against harmful interference in a residential installation. This equipment generates, uses and can radiate radio frequency energy and, if not installed and used in accordance with the instructions, may cause harmful interference to radio communications. However, there is no guarantee that interference will not occur in a particular installation. If this equipment does cause harmful interference to radio or television reception, which can be determined by turning the equipment off and on, the user is encouraged to try to correct the interference by one of the following measures:

- Reorient or relocate the receiving antenna.
- Increase the separation between the equipment and receiver.
- Connect the equipment into an outlet on a circuit different from that to which the receiver is connected.
- Consult the dealer or an experienced radio/TV technician for help.

## FCC Caution

Any changes or modifications not expressly approved by the party responsible for compliance could void the user's authority to operate this equipment.

- This device complies with Part 15 of the FCC Rules. Operation is subject to the following two conditions:
  - 1) This device may not cause harmful interference.
  - 2) This device must accept any interference received, including interference that may cause undesired operation.
- This device and its antenna must not be co-located or operating in conjunction with any other antenna or transmitter.
- If this device is going to be operated in 5.15 ~ 5.25GHz frequency range, then it is restricted in indoor environment only.

## FCC Radiation Exposure Statement

This equipment complies with FCC radiation exposure limits set forth for an uncontrolled environment. This equipment should be installed and operated with minimum distance 20cm between the equipment and your body.

## Recycling Information



This symbol on the product or on its packaging indicates that this product shall not be treated as household waste. Instead please deliver it to the applicable collection point for the recycling of electrical and electronic equipment. By recycling this product correctly, you will help conserve natural resources and prevent potential negative environmental consequences. For more detailed information about recycling of this product, please contact your local city office, your household waste disposal service or the shop where you purchased the product.

## Technical Support and additional information

Please visit [www.airfonix.com](http://www.airfonix.com) for:

- Information and help with troubleshooting and support issues.
- To contact customer service.
- United States customers may contact customer service at (888) 778-2446. For other countries, visit [www.airfonix.com](http://www.airfonix.com) to find the correct telephone number for your country.
- For the latest product documentation, as well as the Airfonix License Agreement and Limited Warranty.

**NOTE:** this document contains information that is subject to change without notice. For the latest product documentation, as well as the Airfonix License Agreement and Limited Warranty go to [www.airfonix.com](http://www.airfonix.com).

## R Series model AFX-19AR050

## Features

Dimensions
Weight
Outputs
MONO Mode
Stereo Mode
RF Performance
Frequency of Operation
Channel Spacing
Transmitter Output Power
Range
Audio Quality
Pulse-code Modulation
Sampling rates
THD+N/SNR @
Analog I/O
Frequency response
S/N
RF Latency
Security
Operating Temperature

## Performance

158mm, Height: 51mm, Depth: 131mm
0.55 Kg, 1.21 lbs
5-way binding posts
50 watts RMS/mono at less than 1%THD rated at 35 to 20 KHz
25 watts RMS/ch at less than 1%THD rated at 35 to 20KHz
License-free bands (see table)
20 MHz
15 dBm, typical
50m minimum for one-room applications, up to 100m for line-of-sight applications
Up to 24-bits resolution, (PCM) bits compatible with 16-bits stereo
48 kHz
Tx to Rx, THD+N = 0.4% (1W)
20Hz~20KHz +/-0.5dB
A-weighted better than 70dB@1W
10 ms
6 Bytes (48 bits) of IEEE 802.3-like MAC address
0 to +60° C

## R Series model AFX-19PR001

## Features

Dimensions
Weight
Outputs
RF Performance
Frequency of Operation
Channel Spacing
Transmitter Output Power
Range
Audio Quality
Pulse-code Modulation
Sampling rates
Frequency response
S/N
RF Latency
Security
Operating Temperature

## Performance

158mm, Height: 51mm, Depth: 85mm
0.35 Kg, 0.77 lbs.
RCA line out, XLR balanced OUT
License-free bands (see table)
20 MHz
15 dBm, typical
50m minimum for one-room applications, up to 100m for line-of-sight applications
Up to 24-bits resolution, (PCM) bits compatible with 16-bits stereo
48 kHz
20Hz~20KHz +/-0.5dB
A-weighted better than 90dB@full scale
10 ms
6 Bytes (48 bits) of IEEE 802.3-like MAC address
0 to +70° C

## T Series model AFX-19PT002

### Features

Dimensions

Weight

Inputs

SPDIF source

RF Performance

Frequency of Operation

Channel Spacing

Transmitter Output Power

Range

Audio Quality

Pulse-code Modulation

Sampling rates

RF Latency

Security

Operating Temperature

### Performance

Width: 158mm, Height: 51mm, Depth: 85mm

0.35 Kg, 0.77 lbs

RCA line in, XLR balanced IN, and coaxial/optical SPDIF

Non-compressed 44.1KHz or 48KHz sampling rate

License-free bands (see table)

20 MHz

15 dBm, typical

50m minimum for one-room applications, up to 100m for line-of-sight applications

Up to 24-bits resolution, PCM) bits compatible with 16-bits stereo

48 kHz

10 ms

6 Bytes (48 bits) of IEEE 802.3-like MAC address

0 to +60° C

## T Series model AFX-19PT102

### Features

Dimensions

Weight

Inputs

SPDIF source

RF Performance

Frequency of Operation

Channel Spacing

Transmitter Output Power

Range

Audio Quality

Pulse-code Modulation

Sampling rates

RF Latency

Security

Operating Temperature

### Performance

Width: 158mm, Height: 51mm, Depth: 85mm

0.35 Kg, 0.77 lbs

RCA line in, Dual High-level input (spring terminal), and coaxial/optical SPDIF

Non-compressed 44.1KHz or 48KHz sampling rate

License-free bands (see table)

20 MHz

15 dBm, typical

50m minimum for one-room applications, up to 100m for line-of-sight applications

Up to 24-bits resolution, PCM) bits compatible with 16-bits stereo

48 kHz

10 ms

6 Bytes (48 bits) of IEEE 802.3-like MAC address

0 to +70° C