

# USER MANUAL

## LCI-80x Pressure Display

Revision 1.20  
July 3rd, 2014

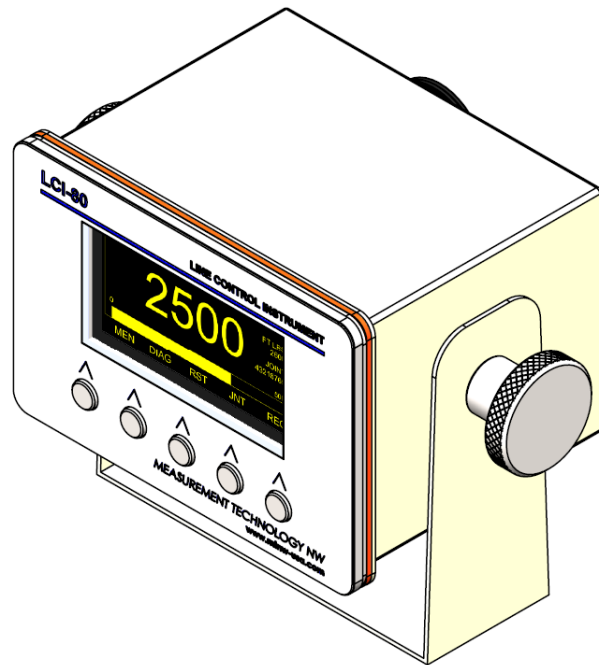

4211 24<sup>th</sup> Ave West  
Seattle WA 98199  
USA

Phone: 206.634.1308  
Fax: 206.634.1309  
Email: [LCI@mtnw-usa.com](mailto:LCI@mtnw-usa.com)  
Copyright 2014

## Table of Contents

<b>1.0</b>	<b>Overview .....</b>	<b>5</b>
<b>1.1</b>	<b>New Features of the LCI-80x.....</b>	<b>5</b>
<b>2.0</b>	<b>Mechanical Installation.....</b>	<b>6</b>
<b>2.1</b>	<b>Environmental Considerations.....</b>	<b>6</b>
<b>2.2</b>	<b>Dimensions and Cutout.....</b>	<b>6</b>
<b>2.3</b>	<b>Display Mounting .....</b>	<b>6</b>
<b>2.4</b>	<b>Ventilation Requirements.....</b>	<b>6</b>
<b>2.5</b>	<b>Cleaning Instructions .....</b>	<b>6</b>
<b>3.0</b>	<b>Wiring Diagrams.....</b>	<b>7</b>
<b>3.1</b>	<b>Wiring Hookup – Local Display.....</b>	<b>7</b>
3.1.1	Display power and fuse.....	7
3.1.2	Power for Field Sensors .....	8
3.1.3	Pressure Sensor Inputs .....	8
3.1.4	Alarm Outputs .....	11
3.1.5	Analog Outputs .....	11
3.1.6	Serial Communications.....	12
3.1.7	Ethernet Communications.....	12
<b>4.0</b>	<b>Local Display Operation .....</b>	<b>14</b>
<b>4.1</b>	<b>Front Panel Identification.....</b>	<b>14</b>
<b>4.2</b>	<b>Programming Menu .....</b>	<b>14</b>
<b>4.3</b>	<b>Alarms .....</b>	<b>15</b>
4.3.1	Acknowledging alarms .....	16
4.3.2	Setting alarm limits .....	16
4.3.3	Configuring Alarms .....	16
<b>4.4</b>	<b>Calibration .....</b>	<b>18</b>
4.4.1	Scale and offset.....	18
4.4.2	Two-point live calibration .....	18
4.4.3	Look-up tables .....	20
<b>4.5</b>	<b>Display Configuration.....</b>	<b>20</b>
4.5.1	Locating variables on screen.....	20
4.5.2	Setting display units.....	21
4.5.3	Setting decimal places .....	22
4.5.4	Setting Bar Graph Range .....	22
4.5.5	Screen Saver .....	22
4.5.6	Display Refresh Rate .....	22
<b>5.0</b>	<b>Hardware Configuration .....</b>	<b>24</b>
<b>5.1</b>	<b>ADMIN.....</b>	<b>24</b>
5.1.1	NAME .....	24
5.1.2	LANGAUGE .....	24
5.1.3	SECURITY.....	24
5.1.4	FACTORY SETUP .....	24
5.1.1	Save Setup .....	25

5.1.2	Load Setup .....	25
5.1.3	Current Setup .....	25
5.1.4	DATE and TIME .....	26
<b>5.2</b>	<b>SENSOR CONFIG .....</b>	<b>26</b>
5.2.1	SAMPLING .....	26
5.2.2	PRESSURE SETUP .....	26
5.2.3	AIN CONFIG .....	26
5.2.4	AOUT CONFIG .....	28
5.2.5	Calibrating the analog output signal .....	28
5.2.6	DIG I/O CONFIG .....	29
<b>5.3</b>	<b>Communication .....</b>	<b>29</b>
<b>5.4</b>	<b>USB STORAGE.....</b>	<b>29</b>
<b>6.0</b>	<b><i>Troubleshooting .....</i></b>	<b>31</b>
<b>6.1</b>	<b>Troubleshooting procedures.....</b>	<b>31</b>
<b>6.2</b>	<b>Technical support.....</b>	<b>34</b>
<b>7.0</b>	<b><i>Appendix A – Dimensional Drawing .....</i></b>	<b>35</b>
<b>8.0</b>	<b><i>Appendix B – DIP Switch Settings.....</i></b>	<b>36</b>
<b>9.0</b>	<b><i>Appendix C – LCI-80x Specifications .....</i></b>	<b>37</b>
<b>10.0</b>	<b><i>Appendix D – LCI-80x Wire List .....</i></b>	<b>39</b>
<b>11.0</b>	<b><i>Appendix E – LCI-80x Terminal Board Interface .....</i></b>	<b>40</b>
<b>12.0</b>	<b><i>Appendix F – LCI-80x Gimbal Bracket Mounting Footprint .....</i></b>	<b>41</b>

## **Figures**

Figure 1.1 Illustration of the LCI-80x.....	5
Figure 11.1 LCI-80x Terminal Board Interface.....	40
Figure 12.1 LCI-80x Gimbal Bracket Dimensions.....	41

## **Tables**

Table 3.1 Identification of hardware interconnect and DIP Switch.....	7
Table 3.2 Fuse Rating and Replacement Part Numbers .....	8
Table 3.3 Regulated DC Power Supplies for Field Sensors .....	8
Table 4.1 Contact Relay Module Locations .....	17
Table 4.2 Available Pressure Units.....	22
Table 5.1 Analog Input Channel Definitions .....	27
Table 5.2 Analog Output Locations and Menu Names.....	28
Table 8.1 RS-485 Termination Settings.....	36
Table 8.2 Analog Input Termination Settings.....	36
Table 10.1 LCI-80x Wire List .....	39

## 1.0 Overview

The LCI-80x Pressure Display is a versatile instrument that displays pressure, and peak pressure for pressure monitoring applications. The LCI-80x is the next generation of the LCI display series. It is a direct replacement for existing LCI-80 units. The front panel and display technology have been retained as they have been proven to be robust and reliable. The internal electronics have been upgraded for improved performance and to provide new features.

The high visibility electro-luminescent display shows signals from a pressure sensor in engineering units. The display and the five front panel keys allow the operator to clear the peak pressure, zero the current reading, and manipulate the calibration and configuration menus. The label that appears above each key indicates the function on the display. As the operator navigates through various screens the functions of these keys and their associated labels will change. The operator can configure the LCI-80x to accept inputs from a range of pressure sensors (millivolt or milliamp output) and calibrate their outputs.

This manual covers the installation, set-up, and operation of the LCI-80x.

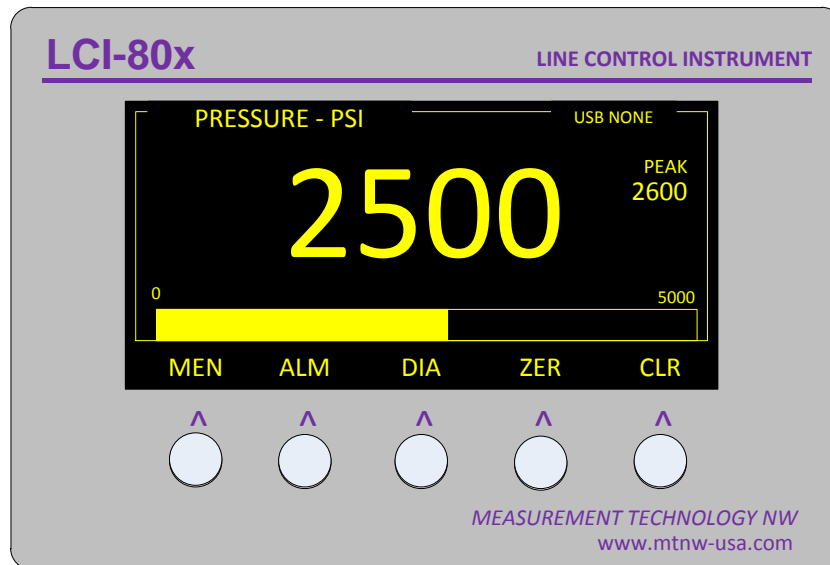

Figure 1.1 Illustration of the LCI-80x

### 1.1 New Features of the LCI-80x

- Pressure and peak pressure on one screen.
- USB Data Logging in CSV format
- Strain gauge input channels, no external module required
- Two onboard SPDT dry contact relays, no external modules required
- Baud rate selectable for RS-232 and RS-485
- Ethernet port, 10 base T, UDP and TCP/IP
- Display update rate user selectable
- User selectable pressure units
- Save and load up to 4 different setups
- Real-time clock for date and time, all data is time stamped

## 2.0 Mechanical Installation

The LCI-80x is designed for mounting on the front-panel of an electrical enclosure with a suitable environmental rating. The sealed front face of the LCI-80x is made of a laminated stainless steel assembly and the slotted rear cage is designed to promote heat transfer, facilitate field wire terminations, and provide a purchase point for the panel clamps. The front face is 3.9" high x 5.6" wide and the total depth is 2.38" (measured from the rear of the stainless steel front panel to the rear extremity of the LCI-80x's enclosure).

### 2.1 Environmental Considerations

The front face of the LCI-80x is designed for NEMA 4X applications. It consists of a 316 stainless steel top layer, a sealed polycarbonate window, and five membrane-sealed stainless steel push buttons. A polyurethane gasket, held in-place by a high temperature adhesive is applied to the backside of the front face. When mounting the LCI-80x in exposed locations, a front-panel cover is recommended to protect the unit when it is not in use.

The standard temperature range of the LCI-80x is  $-40^{\circ}\text{C}$  to  $+70^{\circ}\text{C}$ .

### 2.2 Dimensions and Cutout

The LCI-80x will fit in a 5.27" x 3.55" cutout (tolerance  $-0.01$ ,  $+0.100$ ); with a minimum of 2.38" depth clearance (see Appendix A for dimensional drawing). The enclosure's front panel can be up to 5/8" thick.

### 2.3 Display Mounting

The instrument is held in place with removable panel clamps that index into the slotted holes on all sides of the display. Two clamps are included with each display.

After sliding the display into the cutout, clip the two panel clamps on to the sides of the display, using the slotted grooves on the display's enclosure, with the flanged end of the clamp facing away from the panel. Once the panel clamps are installed, tighten the jackscrews against the panel to compress the LCI-80x gasket to seal against the panel. Lock the jackscrews with the provided hex nuts to prevent them from vibrating loose over time. Care should be taken to not over tighten the jackscrews.

### 2.4 Ventilation Requirements

The instrument should be mounted with a minimum of 0.75" spacing between the rear enclosure (all edges) of the display and adjacent equipment to allow for adequate ventilation and heat transfer.

### 2.5 Cleaning Instructions

To clean the front panel of the display, use a clean lint free cloth and a high quality and pure isopropanol. Do not apply the mild solvent directly to the polycarbonate window, instead wet the cloth or wipe first and then gently wipe the window and the stainless steel bezel.

### 3.0 Wiring Diagrams

The LCI-80x can be configured for a wide range of signal input and output functions. Configuration consists of wiring and menu settings, and in the case of analog inputs and RS-485 serial communications, DIP switch settings as well. The wiring diagrams are given in this section. The table below gives of a summary of the LCI-80x functions referenced to their associated menu and DIP switch numbers, required hardware options, and section of this manual covering the wiring termination.

**Table 3.1 Identification of hardware interconnect and DIP Switch**

Function	Menu Number	DIP Switch #
DC Power	N/A	N/A
Power for Field Sensors	N/A	N/A
Analog Input 4-20 mA	4.2.2	SW2
Analog Input DC Voltage	4.2.2	N/A
Analog Input 4 Wire Strain Gauge	4.2.2	N/A
Alarm Output	1.1	N/A
Serial Comm. RS232	4.3.2	N/A
Serial Comm. RS485	4.3.2	SW3
Ethernet Comm.	4.3.1	N/A
USB Mass Storage	4.4	N/A

#### 3.1 Wiring Hookup – Local Display

This section provides wiring diagrams and related specifications for power and signal input and output connections for the LCI-80x.

##### 3.1.1 Display power and fuse

The fuse F3 is located on the rear panel of the display. Use a flat blade screwdriver to open the cover for access. The replacement part is a 5 x 20 mm fuse rated according to the system options. See the table below for fuse sizing.

**WARNING:** Support the bottom of the PCB to prevent bending and possibly damaging the PCB components when removing the fuse.

**Table 3.2 Fuse Rating and Replacement Part Numbers**

<b>Input Power Source</b>	<b>Fuse Rating</b>	<b>Littelfuse Part No</b>
9V <sub>DC</sub>	1.75 A	218002
12V <sub>DC</sub>	1.25 A	2181.25
24V <sub>DC</sub>	0.625 A	218.630
36V <sub>DC</sub>	0.5 A	218.500

An appropriate disconnect device must be installed to provide a means of disconnecting the display from the external power source for servicing. This disconnect device is not provided with this equipment.

The LCI-80x requires a 9-36 V<sub>DC</sub> (nominal 12V<sub>DC</sub>) power source rated at 15 Watts.

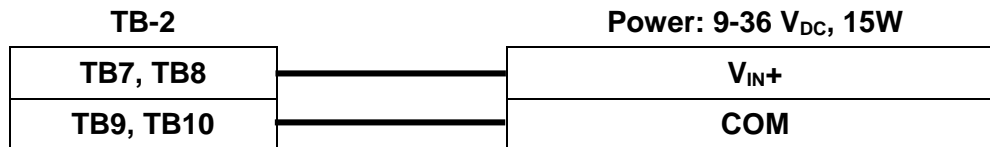
**Figure 4.3 – Local Display Power Hookup – DC Power**

### 3.1.2 Power for Field Sensors

The LCI-80x provides regulated excitation voltage to a variety of field sensors. The table below identifies the power, capacities and terminal block locations.

**Table 3.3 Regulated DC Power Supplies for Field Sensors**

<b>Power</b>	<b>Capacity</b>	<b>Location</b>
+24 V <sub>DC</sub>	0.5 A	TB34, TB35
+5 V <sub>DC</sub>	0.5 A	TB1
+12 V <sub>DC</sub>	0.5 A	TB2
+5 V <sub>DC</sub> Strain Gage	277 mA	TB16, TB19
+10 V <sub>DC</sub> Strain Gage	277 mA	TB16, TB19

### 3.1.3 Pressure Sensor Inputs

The pressure sensor analog inputs are terminated on TB-6 for high-level input and TB-3 for low-level strain gauge signals.

TB-3 can accept +/-20mV or +/-100mV strain gauge inputs. The strain gauge input is referenced in the Menu System as **AIN-3**.



TB6 can accept 4-20 mA, 0-5 V<sub>DC</sub>, 0-10 V<sub>DC</sub> and ±5 V<sub>DC</sub> sensors. The analog inputs are referenced in the Menu System as **AIN-1** and **AIN-2**.

Pressure sensors can be powered externally, from the same 24 V<sub>DC</sub> used by the display (as long as it is regulated), or from the regulated 24 V<sub>DC</sub> or 12 V<sub>DC</sub> provided by the LCI-80x display.

**Note: The terminal labeled V<sub>IN+</sub> on TB-2 is the power input for the display. It is not the regulated supply output for sensor excitation. If the same power is used for both the display and the sensor, it is the responsibility of the user to ensure that the power supply is regulated to meet the requirements of the sensor and the display.**

Each input type must match the setting in menu 4.2.2. In addition, TB-6 analog inputs must match the SW2 DIP switch settings on the rear of the display, which selects between 4-20mA and voltage type inputs. Each TB-3 input channel may be set independently. Appendix B indicates how to set the DIP switch for the desired function.

Below are the wiring diagrams for the different sensor types and excitation scenarios.

**4-20 mA, Three Wire, AIN-1 or AIN-2**

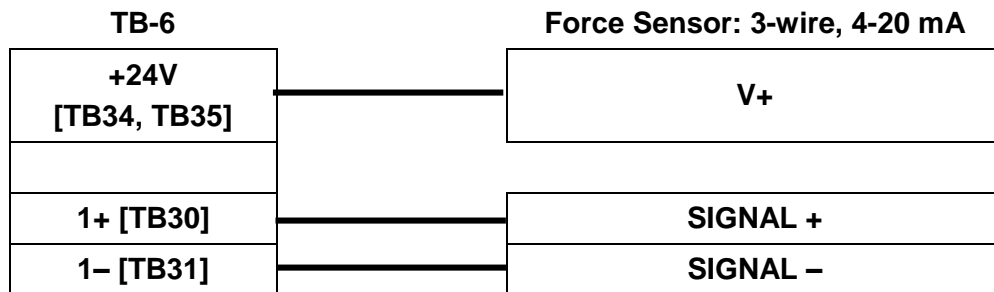

**Figure 4.5 – Sensor Hookup – 3-wire 4-20 mA Signal**

**4-20 mA, Four Wire, AIN-1 or AIN-2**

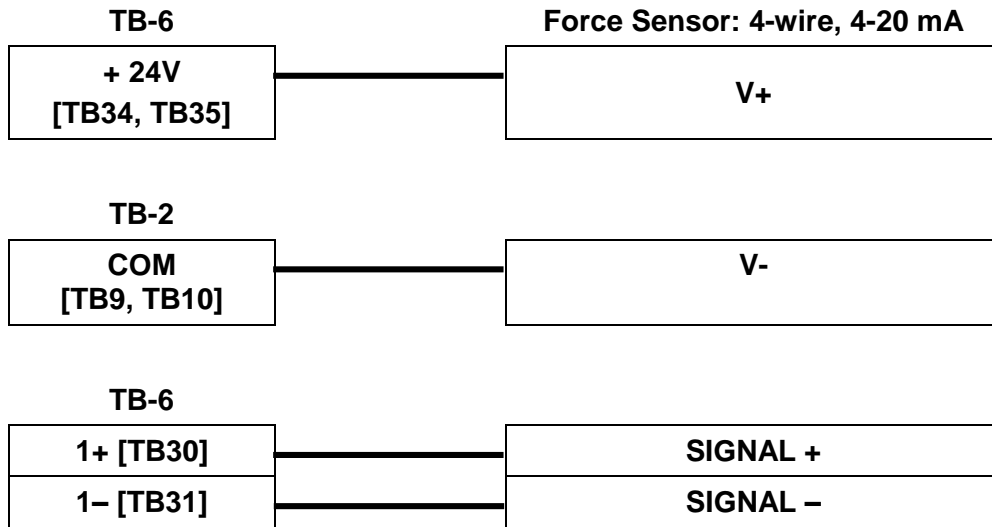

Figure 4.6 – Sensor Hookup – 4 Wire 4-20 mA Signal

**4-20 mA, Two Wire, AIN-1 or AIN-2**

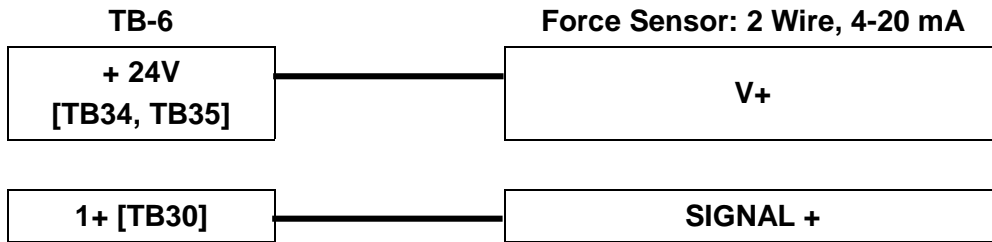

Figure 4.7 – Sensor Hookup – 2 Wire 4-20 mA Signal

**DC Voltage, +24 Volt Excitation, AIN-1 or AIN-2**

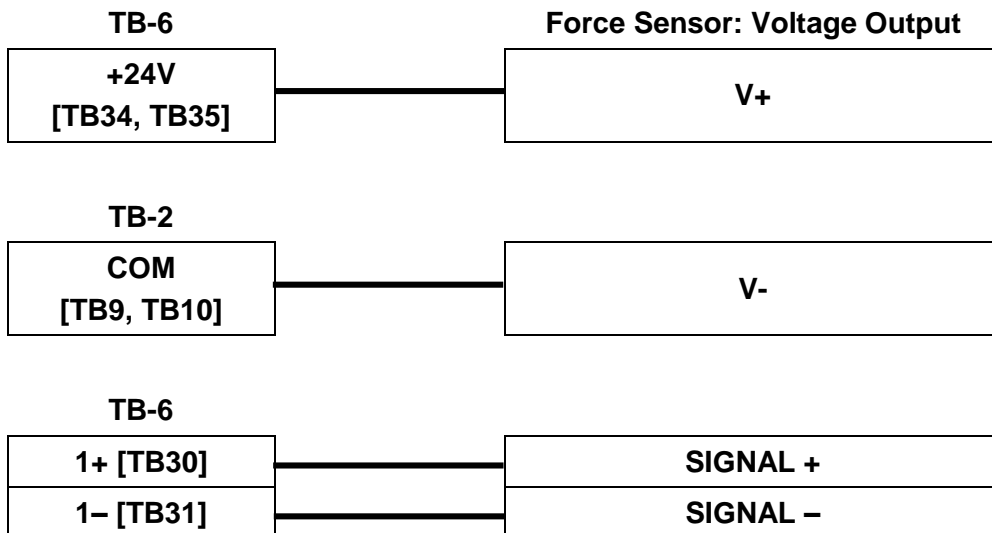

Figure 4.8 – Sensor Hookup – 4 Wire DC Voltage Input

**4 Wire Strain Gauge, AIN-3**

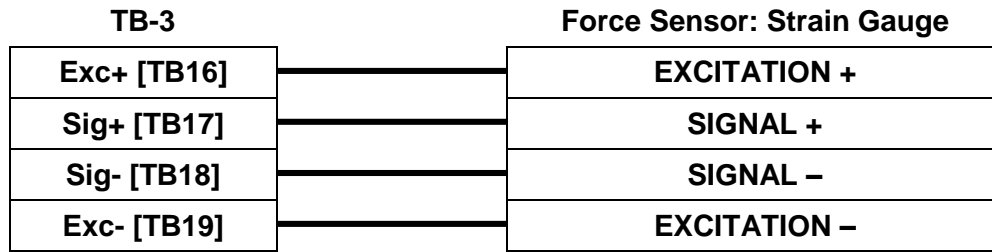

Figure 4.9 - Strain Gauge Input - 4-wire Strain Gauge

**3.1.4 Alarm Outputs**

The two alarm outputs are terminated on TB-6. The LCI-80x uses internal SPST dry contact relays to implement the alarm outputs.

**Alarm Outputs (2 channels total)**

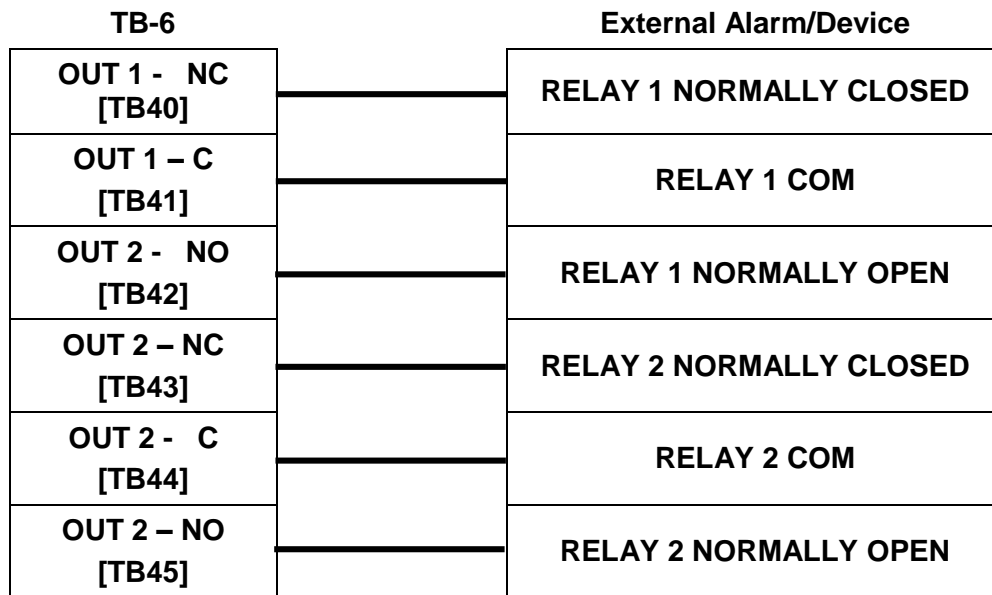

Figure 4.16 – Alarm Output Hookup – 2 Channels

**3.1.5 Analog Outputs**

The LCI-80x provides four analog outputs on TB2. These outputs can be 4-20 mA, 0-5 V<sub>DC</sub>, 0-10 V<sub>DC</sub> or ±5V<sub>DC</sub>. Below are wiring diagrams for the different output types.

**Analog Outputs (2 channels total)**

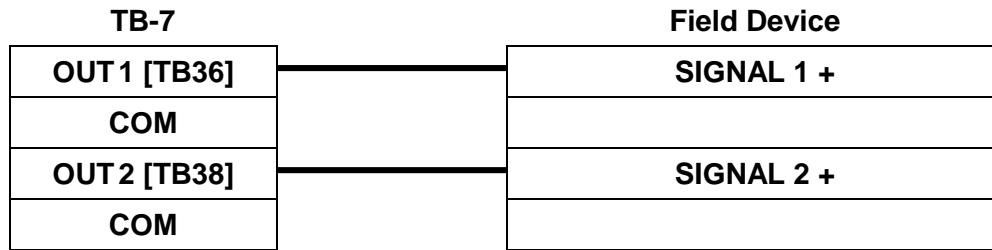

Figure 4.19 – Analog Output Connections – 2 Channels

**3.1.6 Serial Communications**

The LCI-80x provides RS-232 and RS-485 serial communication options. For long cable runs or multi-drop applications, use the electrically-isolated RS-485 port.

The RS-485 serial termination is set using the DIP switch settings (SW3) shown in Appendix B.

Below are the wiring diagrams for all serial communications options.

**RS-232 Connection**

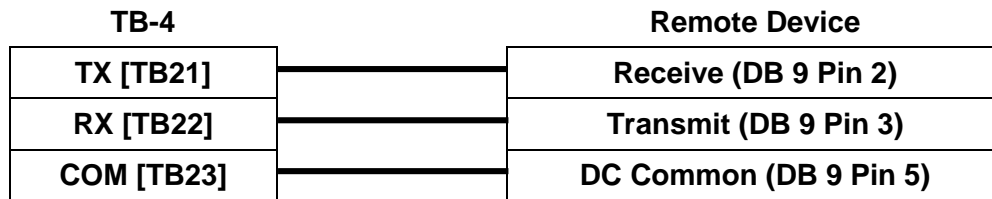

Figure 4.21 – RS-232 Communication Connections

**RS-485 Connection**

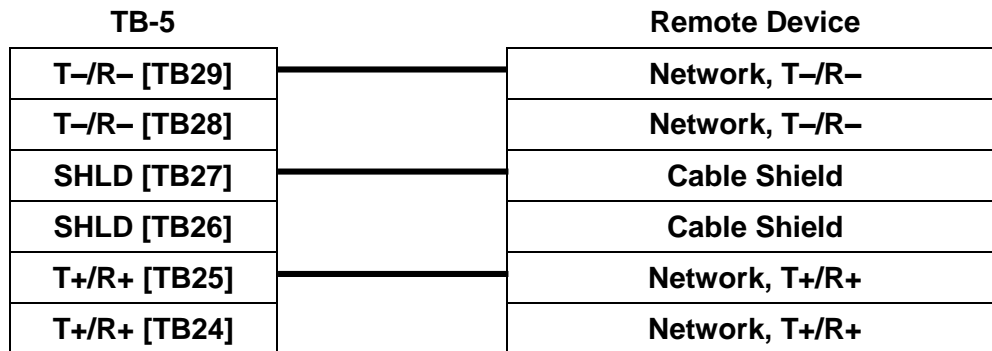
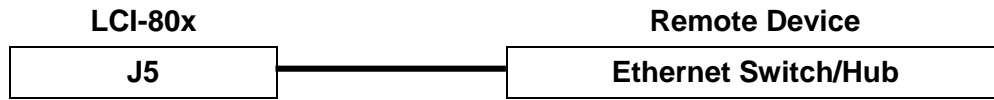

Figure 4.23 – RS-485 Network Communication Connections

**3.1.7 Ethernet Communications**

The LCI-80x has an Ethernet port on the rear of the unit designated J5. This is the preferred interconnect for exchanging data between local units and remote devices. Any standard Ethernet cable can be used if the LCI-80x is being plugged into a router, hub or switch. However, if connecting the LCI-80x directly to a PC or another LCI-80x, a cross-over cable is required.

**Ethernet Connection – Hub/Switch**



**Figure 4.24 – Ethernet Communication Hookup**

## 4.0 Local Display Operation

This section describes the user operation of the LCI-80x.

### 4.1 Front Panel Identification

The LCI-80x front panel features a high visibility display and a five-button keypad. Each key has a label at the bottom of the screen that identifies its function. The operating mode of the instrument is changed when a key is pressed.

Upon start-up the instrument displays the Main Screen. The pressure and peak pressure are displayed. The pressure measurement is updated in real-time and the peak pressure captures the greatest pressure measurement.

The functions of the five menu keys during RUN mode are as follows:

- MEN** Displays the menu for programming and calibrating the unit.
- ALM** Clears any active relays in the event of an alarm condition
- DIA** Displays the system diagnostic screen.
- ZER** Zeroes out the main pressure display by applying a tare offset to the measurement. An asterisk will be displayed at the top of the screen to indicate that tare mode is active. Pressing ZER a second time deactivates the tare.
- CLR** Resets the peak pressure measurement. When pressed the peak pressure will zero for two seconds and then capture the peak pressure value.

<b>PR - MAIN MENU</b>	
> 1	<b>SET ALARMS</b>
2	<b>CALIBRATION</b>
3	<b>DISPLAY CONFIG</b>
4	<b>SYSTEM CONFIG</b>

Item 1 Displays the Alarm Summary menu.

Item 2 Displays the Calibration menu.

Item 3 Displays the Display Configuration menu.

Item 4 Displays the System Configuration menu.

### 4.2 Programming Menu

The LCI-80x is user programmable via the front panel keypad and the display. Programming options include selection of input/output signal ranges, setting screen displays and formats, defining alarm points, and calibrating the unit.

Pressing the **MEN** key displays the **PR - MAIN MENU** screen. The key labels also change to indicate the functions they perform in **Menu** mode, allowing the user to navigate through the menu system and select menu items. Once an item is selected, the keypad labels change again to reflect their uses in **Edit** mode for modifying data fields.

In Menu mode the keys have the following labels and functions:

<b>RUN</b>	<b>UP</b>	<b>DWN</b>	<b>ENT</b>	<b>ESC</b>
------------	-----------	------------	------------	------------

- RUN** Returns to the Run Display, saving any changes made to menu items
- UP** Moves the cursor up the menu
- DWN** Moves the cursor down the menu
- ENT** If the pointer indicates a sub-menu the selected sub-menu will be displayed. If the pointer indicates a data field, enters **Edit** mode to allow changes on the selected field.
- ESC** Moves back one menu level. Pressing this button from the top menu returns the LCI-80x to Run mode and display the Main Screen.

When a data field is selected with the **ENT** key, the labels and functions of the keypad change to **Edit** mode as shown below.

<b>DEC</b>	<b>INC</b>		<b>ENT</b> →	<b>ESC</b>
------------	------------	--	--------------	------------

- DEC** Decreases the selected digit by one when editing a numeric field, or reverse scrolls through a list of available options.
- INC** Increases the selected digit by one when editing a numeric field, or scrolls through a list of the available options.
- Moves the edit cursor to next digit in data field, or scrolls through a list of choices.
- ENT** Accepts the edited value and returns to **Menu** mode
- ESC** Rejects the edited value and return to **Menu** mode

### 4.3 Alarms

The LCI-80x provides the user with up to six visual alarms that can be configured to indicate high and low conditions of pressure. Each alarm can also be assigned to any one of the two relay output channels that could be used to drive lights and/or audible alarms.

Two separate menus are used for alarms. One menu is dedicated to adjusting alarm limits only. A separate menu is used when setting up the instrument to identify the alarm variable and type, enable relay outputs, and set the dead-band for each channel.

#### 4.3.1 Acknowledging alarms

When an alarm event occurs the color of the measurement display is inverted. This display remains on the screen as long as the alarm condition exists. The display will return to normal when the variable causing the alarm changes to a value beyond the dead-band range. If the user configures the alarm to switch a relay output, the relay will track the screen display: it will energize when the alarm event occurs and de-energize when the condition goes away. If multiple alarms use the same output relay, then all alarm conditions must clear before the relay will de-energize.

Pressing the **ALM** key after an alarm condition occurs will de-energizes all the relays. They will remain de-energized until a new alarm condition is generated. Note that even when an alarm is acknowledged by pressing the **ALM** key, the on-screen alarm indication remains until the condition goes away.

#### 4.3.2 Setting alarm limits

From the RUN screen press **MENU** and select the **1.0 ALARM SUMMARY** item.

For configured alarms, upper limits are indicated by a greater-than sign “>”, and lower limits by a less-than sign “<”. Press **ENT** to change the set point using the **DEC, INC** and **→** keys. Save the change with the **ENT** key. Keep the old value with the **ESC** key. Push the **RUN** key to return to the Run screen.

1.0 ALARM SUMMARY	
> 1	EDIT ALARMS
2	PRESSURE 1000 PSI
3	NONE
4	NONE

#### 4.3.3 Configuring Alarms

To configure the alarm settings, go to menu **1.1 EDIT ALARMS**



1.1 EDIT ALARMS		
> 1	ALARM	1
2	ENABLE	ON
3	INPUT	PRESSURE
4	TYPE	HIGH
5	LIMIT	1000PSI
6	DEADBAND	20PSI
7	RELAY	CR 1

- Item 1 Directs the configuration to alarm numbers 1–6. Edit this field first to view the information for the desired alarm channel
- Item 2 Determines if the alarm is ON or OFF.
- Item 3 Sets the alarm to monitor pressure.
- Item 4 Selects HIGH or LOW alarm conditions. A high alarm is active when the variable exceeds the limit. A low alarm is active when the variable is below the limit. An algebraic comparison is used, thus a pressure of “–60” is *below* a limit of “–50”.
- Item 5 This is the numerical value at which the alarm is triggered.
- Item 6 Sets the dead-band associated with the alarm setting. The dead-band value prevents chattering. The alarm turns on at the limit specified and remains on until the line variable is less than LIMIT – DEADBAND for high alarms, or greater than LIMIT + DEADBAND for low alarms.
- Item 7 Relates the alarm condition to an output relay as shown in the table below.

**Table 4.1 Contact Relay Module Locations**

Setting	Hardware/Terminal Block
CR1	TB-6 [TB40, TB41]
CR2	TB-6 [TB43, TB44]

## 4.4 Calibration

The LCI-80x Pressure Display can be calibrated using three methods: Scale and Offset, Two-Point Calibration, and Look-up Table.

### 4.4.1 Scale and offset

The Scale and Offset values displayed in Menu 2.1 are the actual numbers used to calculate the displayed Pressure. The Scale and Offset calibration method should be used if the sensor specifies a calibrated full scale.

Select Item 2 and enter the full-scale pressure sensor output in the specified units. The full-scale value corresponds to the pressure at 20 mA on a 4-20 mA device. Next, select Item 3 and enter the Pressure offset. The offset corresponds to the pressure at 4 mA on a 4-20 mA device.

2.1 TORQUE CALIB.		
1	CAL. TYPE	SCL/OFS
> 2	FULL SCALE	2500 PSI
3	OFFSET	50 PSI

Once the calibration values have been entered, either press **RUN** to save the values and return to the run screen, or to discard the changes, press **ESC**.

### 4.4.2 Two-point live calibration

The Two-point live calibration method allows the Pressure input to be calibrated using actual pressure measurements in the field. The two-point live calibration automatically calculates the Scale and Offset values based on the applied pressure. When you perform a two-point live calibration, the previous Scale and Offset values are automatically updated to reflect the new calibration. This eliminates the chance of conflicting calibration values in the two modes. *If the existing numbers are significant, they should be recorded before beginning this procedure.*

The menu for using the two point live calibration functions, **2.1 CALIBRATION**, is shown below. Two known pressures are required to perform this calibration. Ideally these pressures are near each end of the normal working range, but not at either full-pressure or zero-pressure.

2.1 CALIBRATION		
> 1	CAL. TYPE	TWO-PT
2	LIVE/EDIT	LIVE
3	LOW	50 PSI
4	HIGH	9500 PSI
5	IN LOW	4.013 mA
6	IN HIGH	16.547 mA

### Calibration Process

- 1) Apply known or measured **LOW** pressure to the system.

*Note: Using zero lbs. of pressure is acceptable*

- 2) Move to Item 3 using the **DOWN** key and press **ENT**. Edit the **LOW** value to correspond to the applied pressure. Press **ENT** when complete.
- 3) Set Item 2 to **LIVE**. This will make the LCI-80x read live data from the pressure input sensor for the calibration. As an alternative, **EDIT** allows the user to manually set the **IN LOW** and **IN HIGH** values.
- 4) Move to Item 5 using the **DOWN** key and press **ENT**. The number shown will be a real-time measurement of the input signal. It should be near the low end of its full range for low pressure conditions. The message above the keypad now reads:

**PRESS ENT TO GRAB ENT ESC.**

Once the reading has stabilized, press **ENT** to grab the value, or **ESC** to cancel the reading.

- 5) Repeat, applying a known or measured **HIGH** pressure to the sensor.
- 6) Move to Item 4 using the **UP** key and press **ENT**. Edit the **HIGH** number to correspond to the applied Force. Press **ENT** when complete.
- 7) Move to Item 6 using the **DOWN** key and press **ENT**. The number shown will be a real-time measurement of the input signal. It should be near the high end of its full range for high pressure conditions. The message above the keypad now reads:

**PRESS ENT TO GRAB ENT ESC.**

Once the reading has stabilized, press **ENT** to grab the value, or **ESC** to cancel the reading.

- 8) While not recommended, the user may sometimes need to edit the **INPUT LOW** and **INPUT HIGH** fields. This may be accomplished by moving to Item 2 and changing it from **LIVE** to **EDIT**. This allows the **INPUT HIGH** and **LOW** values to be edited like any other menu item.

- 9) Press the **RUN** key to apply the two-point linear fit to the scale and offset values and save the results.

#### 4.4.3 Look-up tables

The menu for selecting a look-up table calibration function is shown below with some sample user-defined lookup tables. Select Item 2 to calibrate the Pressure input signal using one of up to four look-up tables (labeled A through D). These tables are intended to be installed by factory-trained personnel, based on calibrations made on a test stand.

2.3 CALIBRATION		
1	CAL TYPE	LOOKUP
> 2	USE TABLE	A
3	EDIT TABLE	

### 4.5 Display Configuration

The LCI-80x allows the user to change the look of the measurement data on the **RUN** screen, change the units of measure, the number of decimal places, implement a screen saver to prolong the life of the display, change the display refresh rate and the change the number of winches displayed. These features are accessed via the **3.0 DISPLAY CONFIGURATION** menu.

3.0 DISPLAY CONFIG		
> 1	PRIMARY DISPLAY	
2	REFRESH Hz	10
3	SCREEN SAVER	ON
4	CONTRAST	10

#### 4.5.1 Locating variables on screen

The LCI-80x screen has three locations for displaying measurement data. The **PRIMARY** location can display up to 6 digits, and is usually used for the most important parameter since it includes a **bar graph** beneath the numeric display.

If the number is too large for the assigned space, the rightmost digits are clipped to make it fit. In this case, the LCI-80x will display “**OR**” over the top of the rightmost digit to indicate the display is over the digit limit for that field.

The **PRIMARY** is listed below and referenced in the following sections.

3.1 PRIMARY DISP.		
> 1	VARIABLE	PRESSURE
2	UNITS	PSI
3	DEC. PLCS.	0
4	BAR MIN	0 PSI
5	BAR MAX	2500 PSI
6	BAR WIDTH %	100

Item 1 Specifies the display variable. This is fixed.

Item 2 Specifies the display units.

Item 3 Specifies the number of decimal places.

Item 4 Specifies the minimum value of the bar graph on the Primary Display.

Item 5 Specifies the maximum value of the bar graph on the Primary Display.

Item 6 Specifies the width value of the bar graph on the Primary Display. The Bar Graph Width is used to change the bar graph into an indicator with a width specified by the value entered.

#### 4.5.2 Setting display units

Each displayed variable can be individually set to use one of several common units. The LCI-80x was designed to be **units-aware**, meaning that any of the display units can be switched during operation without requiring re-calibration or re-setting set points. For example, if the RUN screen shows **3000 PSI** on the Pressure display and has an alarm set point of 2000 psi, changing Pressure units to KPa causes the screen to immediately display **20684 KPA** and the alarm set point to change to 13789 KPA with no other user input necessary.

The available units, and their abbreviations, are listed in the table below.

**Table 4.2 Available Pressure Units**

Variable	Units – Abbreviation
Pressure	Pounds per square inch – psi - PSI
	Pascals - Pa – PA
	Kilopascals - KPa – KPA
	Megapascals – MPa – MPA
	Bar – bar - BAR

### 4.5.3 Setting decimal places

Item 3 in menus **3.1 PRIMARY DISPLAY** sets the maximum number of digits displayed to the right of the decimal point for each line variable. To select decimal places scroll through the choices with the **INCR** or **→** keys, and push **ENT** when the desired value is displayed.

The Primary Display element can be set to have as many as 3 decimal places. If the value has too many digits for the assigned screen location, then trailing decimals are automatically dropped to make the number fit the available space. If the number is still too wide for the assigned space, then the rightmost digits are clipped to make it fit. In this case, the LCI-80x displays “**OR**” on top of the rightmost digit to indicate that the display is over the digit limit for that field.

### 4.5.4 Setting Bar Graph Range

The top display of the LCI-80x includes a bar graph for visual indication of the current operating condition. The full scale of the bar graph can be set by the user via item 4, 5, and 6 in menu **3.1 PRIMARY DISPLAY**. This full scale value is only used for the bar graph upper limit.

The Pressure input has a well-defined full scale limit based on the calibration and input range of the Pressure input channels. The LCI-80x calculates this full scale Pressure after every calibration operation, automatically updating menu 3.1 Item 5. This ensures that the full scale of the Pressure bar graph is the true full scale of the sensor as calibrated. After calibration, the full scale value can be adjusted by the user to change the upper limit on the graph if desired.

### 4.5.5 Screen Saver

The LCI-80x is equipped with a screen saver to prolong the life of the display. The screen will go blank after 30 minutes if the unit has not detected an operator key press. To re-energize the display, simply push any front panel button.

### 4.5.6 Display Refresh Rate

The Display Refresh Rate defines how fast the display will display the line parameters data. It does not affect how fast the processor is running and sampling/logging the data; this is only a visual artifact. The menu setting allows the operator to select a display refresh rate of between 1 Hz and 30 Hz (or 30 updates per second). Select Item 4 and press **ENT** to activate the edit keys. Use the **INCR**,

**DECR**, and **→** keys to change the value. Press **ENT** to save the new value or **ESC** to cancel the changes.

## 5.0 Hardware Configuration

The LCI-80x will work with a wide variety of input sensors, output alarms and data systems. The **4.0 SYSTEM CONFIG** menu, shown below, allows the LCI-80x to be customized for a particular installation. This menu also offers a security feature that locks out unauthorized changes once these settings have been made. However, if unwanted changes are made to the configuration it is possible to return to the "Factory Setup" configuration, which can be customized for a given installation.

4.0 SYSTEM CONFIGURATION	
> 1	ADMIN
2	SENSOR CONFIG
3	COMMUNICATIONS
4	USB STORAGE

### 5.1 ADMIN

#### 5.1.1 NAME

The Name of device is used in data logging and communication data. It is an eight character string that can be used to identify an LCI-80x.

#### 5.1.2 LANGAUGE

Currently the only language available on the LCI-80x platform is English. This menu item will be used for additional languages once implemented.

#### 5.1.3 SECURITY

The Security Code is either **OFF (0)** or **ON**. When Security is **ON** most of the menu functions are disabled.

To change the Security setting, press **ENT**. This will highlight the default value (0=off), and allow the operator to enter a security code. This number can be any value between 1 and 255. This number will become the security unlock code, so it should be kept in a safe place. Once a number is entered (and **RUN** is pressed to save the change), the security lockout feature is enabled, and can only be disabled by re-entering the **same number**.

#### 5.1.4 FACTORY SETUP

Once a LCI-80x has been fully configured and calibrated, the entire setup can be saved to non-volatile memory. To modify or recall the setups, Select Item 4 and press **ENT** to enter the selection, menu **4.1.2 FACTORY SETUP**, shown below.



<b>4.1.2 FACTORY SETUP</b>		
> 1	<b>SAVE SETUP</b>	<b>1</b>
2	<b>LOAD SETUP</b>	<b>1</b>
3	<b>CURRENT</b>	<b>1</b>

The operator can save up to eight user defined setups with a ninth reserved for the factory default settings. The ability to save multiple setups is great for applications such as in rental fleets where different sensors are used.

### 5.1.1 Save Setup

Up to four different setups can be saved to non-volatile memory. By default, the display will use setup number 1. Select Item 1 and press **ENT** to activate the edit keys. Use the **INCR**, **DECR** and **→** keys to change the value. The selections are 1-4. The operator will be prompted with:

**ARE YOU SURE    YES    NO**

Press the key under the desired function. The current settings will then be saved to the specified setup address.

### 5.1.2 Load Setup

Up to four different sets of settings can be reloaded into current memory from non-volatile memory in addition to the factory default set of settings. Select Item 2 and press **ENT** to activate the edit keys. Use the **INCR**, **→** and **DECR** keys to change the value. The selections are 1-4, and FACT. The operator will be prompted with:

**ARE YOU SURE    YES    NO**

Press the key under the desired function. The specified set of settings will then be loaded into the display's memory. Unless the chosen setup is FACT (factory default), the specified set of settings will become the new default setup, and the LCI will always load that setup when it powers up from this point forward.

When the FACT setup is chosen, the display will load the factory default settings. The current default setup will remain as it was previously, so in order for the factory default settings to become permanent it is necessary to re-enter the menu and save the new settings to one of the eight settings spaces.

### 5.1.3 Current Setup

This item indicates the current default setup that is loaded in active memory. This item is read only.

### 5.1.4 DATE and TIME

The LCI-80x contains a real-time clock unit which keeps track of the current date and time, even when the unit is powered down. The **4.1.3 SET DATE/TIME** menu is used to view and edit the current date and time. Press **ENT** on either the date or time to enter edit mode.

4.1.3 SET DATE/TIME		
> 1	DATE	06-03-2010
2	TIME	16:30:15

## 5.2 SENSOR CONFIG

The 4.2 SENSOR CONFIG menu allows the configuration of the analog and digital interfaces.

4.2 SENSOR CONFIG		
> 1	SAMPLING	10 Hz
2	PRESSURE SETUP	
3	AIN CONFIG	
4	AOUT CONFIG	
5	DIG. I/O CONFIG	

### 5.2.1 SAMPLING

The SAMPLING field indicates the rate at which the analog input and output will be sampled. The LCI-80x uses a sigma-delta analog to digital converter. The lower the sample rate the lower the amount noise in the sampling signal. In a periodic sampling system this sets how fast samples are written to a USB mass storage device and how fast data is broadcasted over communication channels.

### 5.2.2 PRESSURE SETUP

The PRESSURE SETUP menu system allows the analog input selection to be configured. In SINGLE mode a single analog input is used as the sensor interface. The sensor INPUT is measured and then converted to Pressure using the Calibration settings specified in the 2.0 TOOL SETUP menu system.

### 5.2.3 AIN CONFIG

The LCI-80x has three analog inputs, each configurable in a number of ways. The following table outlines the input names, where they are situated on the LCI-80x's terminal blocks, and for what signal ranges they can be configured.

**Table 5.1 Analog Input Channel Definitions**

<b>Input Channel</b>	<b>Terminal Block Location</b>	<b>Available Configurations</b>
AIN-1	TB-6 [TB30]	4-20mA input 0-5V input 0-10V input +/-5V input
AIN-2	TB-6 [TB32]	4-20mA input 0-5V input 0-10V input +/-5V input
AIN-3	TB-3 [TB15-20]	+/-20mV Strain gauge input +/-100mV Strain gauge input

The various analog input options are configured through menu **4.2.2 ANALOG CONFIG**, shown below. A description of each item in this menu is given below:

<b>4.2.2 AIN CONFIG</b>		
> 1	<b>CHANNEL</b>	<b>AIN-1</b>
2	<b>RANGE</b>	<b>0 – 5 V</b>

<b>4.2.2 AIN CONFIG</b>		
> 1	<b>CHANNEL</b>	<b>AIN-3</b>
2	<b>RANGE</b>	<b>20mV</b>
3	<b>EXCITATION</b>	<b>5V</b>
4	<b>SENSE</b>	<b>INT</b>

- Item 1 Selects the channel number, AIN-1 to AIN-3. The channels correspond to specific terminal blocks on the back of the LCI-80x as shown in Table 5.1 above.
- Item 2 Selects the input range for the channel being configured. The choices are 4-20 mA, 0-5V, 0-10V, +/-5V, 20mV, AND 100mV.
- Item 3 Specifies the excitation voltage for a strain gauge sensor. This menu item is only available for AIN-3. In 5V mode, the actual excitation voltages will be +2.5V and -2.5V with reference to system ground.
- Item 4 Sets the sense inputs for a strain gauge sensor. This menu item is only available for AIN-3. Six-wire strain gauges require this setting to be **EXT** to connect the sense

lines. Four-wire strain gauges require this setting to be **INT** to disconnect the sense lines.

#### 5.2.4 AOUT CONFIG

The analog output hardware is configured through the **4.2.3 AOUT CONFIG** menu, shown below. The purpose of the analog output channels is to create a signal that mirrors one of the variables over a user determined range.

<b>4.2.3 AOUT CONFIG</b>		
> 1	<b>CHANNEL</b>	<b>1</b>
2	<b>OUTPUT RANGE</b>	<b>0 – 5 V</b>
3	<b>VARIABLE</b>	<b>PRESSURE</b>
4	<b>FULL SCALE</b>	<b>10000 PSI</b>
5	<b>OFFSET</b>	<b>500 PSI</b>

- Item 1 Selects the channel number that the configuration applies to. These channels correspond to specific terminal blocks on the back of the LCI-80x as shown below:

**Table 5.2 Analog Output Locations and Menu Names**

<b>Channel</b>	<b>Terminal Block</b>
AOUT – 1	TB-6 - V1, I1
AOUT – 2	TB-6 – V2, I2

- Item 2 Selects the analog output range for the channel in Item 1. The choices are 4-20 mA, 0-5 V, 0-10V and  $\pm 5V$ .
- Item 3 Assigns the analog output to a given variable.
- Item 4 Sets the analog output full scale value.
- Item 5 Sets the analog output offset.

#### 5.2.5 Calibrating the analog output signal

Items 5 and 6 in the **4.2.3 ANALOG OUTPUTS** menu allow the analog output for a given line variable to be scaled in any way the user desires. Item 6 specifies the "offset", which is the value of the variable that corresponds to the lower limit of the output range – for example, the value that produces 4 mA or 0 V. Line values below the "offset" will be truncated by the analog output circuitry. Similarly, item 5 specifies the value of the line variable that corresponds to the upper limit of the output range, i.e. 20 mA or 5 V, etc. Line values above the "full scale" value generate the maximum output. This flexible arrangement allows the LCI-80x to meet the requirements of almost any conceivable data system or input device.

### 5.2.6 DIG I/O CONFIG

Not available in the Pressure Display.

## 5.3 Communication

The LCI-80x has three communication ports: RS-232, RS-485, and Ethernet. The ports are configurable and support several customized data streams, allowing the LCI-80x to be retrofit into existing applications. The **4.3 COMMUNICATIONS** menu controls how the LCI-80x uses its communications ports.

4.3 COMMUNICATIONS		
> 1	MODE	LOCAL
2	ETHERNET	
3	SERIAL	
4	WIFI	
5	LAN ID.	
6	CONFIGURE REMOTES	NO

- Item 1 Selects **LOCAL** or **REMOTE** modes of operation. **REMOTE** mode configures the LCI-80x into a remote display, receiving data from another LCI-80x through a network communication port rather than from field sensors. See Section 7.0 for details.
- Item 2 As of the release of this document Ethernet is not yet supported for the LCI-80x Pressure Display
- Item 3 As of the release of this document Serial is not yet supported for the LCI-80x Pressure Display
- Item 4 As of the release of this document WiFi is not yet supported for the LCI-80x Pressure Display
- Item 5 Sets the ID number of this LCI-80x. When multiple units are on a single network each unit needs a unique identifier in order to tell them apart.
- Item 6 This item only appears when units are set to **LOCAL** mode. Selecting this item, changing it to **YES**, and pressing **ENT** uploads the entire set of configuration parameters to all remote LCI-80x units or WinchDAC software platforms attached to this unit. See Section 7 for more details.

## 5.4 USB STORAGE

The 4.4 USB STORAGE menu system allows for the safe ejection and indicates status of the drive. If no USB mass storage device is connected, the USB STORAGE menu displays “NO DEVICE”.

<b>4.4 USB STORAGE</b>		
> <b>1</b>	<b>EJECT</b>	<b>OFF</b>
<b>2</b>	<b>LOGGING</b>	<b>ON</b>
<b>3</b>	<b>LOG INT</b>	<b>0.100 secs</b>

Item 1 Allows the safe ejection of the USB mass storage device.

Item 2 Enables recording measurements to the USB drive.

Item 3 Specifies the time interval to record measurements.

## 6.0 Troubleshooting

The LCI-80x was designed with the user in mind. Using full language menus and a minimum of abbreviations makes the programming and operation much easier to understand. Most apparent malfunctions of the instrument can be traced to incorrect wiring, jumper settings, or configuration.

### 6.1 Troubleshooting procedures

<b>Problem</b> Blank Screen		
<b>Possible Causes</b>	<b>Diagnosis</b>	<b>Remedies</b>
Screen saver is on	Activate display by pressing any key or by changing payout	Disable screen saver if screen visibility is required during periods of inactivity
Input power problem	Check voltage between TB-2 $V_{IN+}$ and COM. Voltage is required to be in the range of 9 to 36 V DC.	Repair or replace power source to provide 9-36 $V_{DC}$
Fuse is blown	Check for voltage between TB-2 $V_{IN+}$ and COM. If unit has power and there is no voltage, then the fuse is suspect.	Check and replace fuse
Screen is faulty	Listen closely for high frequency hum coming from within the LCI-80x	Contact Measurement Technology NW
Internal power supply failure	Measure voltage between TB-1 +5 $V_{DC}$ and COM and also +12 $V_{DC}$ and COM. If these voltages are out of range, the internal power supply is suspect.	Contact Measurement Technology NW
CPU failure	Check for communication with remote displays. If remote displays are not updating and the LCI-80x has power, then the CPU is suspect	Contact Measurement Technology NW

<b>Problem</b> No Response or Zero Value for Pressure Signal		
<b>Possible Causes</b>	<b>Diagnosis</b>	<b>Remedies</b>
Incorrect scaling	Check menu 2.2 for correct values of Offset and Full Scale	Recalibrate if incorrect
No sensor input	Press <b>DIAG</b> to view diagnostics screen. Use a multimeter to compare the raw input value with the LCI-80x displayed input	If no input signal, then replace or repair pressure sensor
	Confirm that the sensor has excitation power with a multimeter. If using an external supply, ensure there are no grounding problems.	Review Section 4.1.2 for discussion of pressure input hookup.
	Check menu 4.5 to ensure that the input is configured correctly.	Review Section 6.5 for discussion of analog input configuration.
	Check menu 4.4 and its submenus to ensure that the analog input is connected to the correct sensor, and that the pressure is being displayed.	Review Section 6.4 for discussion of pressure configuration.

<b>Problem</b> Run Screen Visible, No Numeric Values on Screen		
<b>Possible Causes</b>	<b>Diagnosis</b>	<b>Remedies</b>
Incorrect menu configuration	This will occur when a unit is set to Remote mode and doesn't receive valid serial communication.	If unit is supposed to receive sensor input, then change the LOC/REMOTE mode to LOCAL.



<b>Problem</b> "Jumpy" Pressure Signal		
<b>Possible Causes</b>	<b>Diagnosis</b>	<b>Remedies</b>
Electrical noise	Check input signal quality with oscilloscope. For some frequencies, an AC voltmeter can be used to measure the presence or absence of noise on a DC signal.	Use shielded cabling and/or conduit for sensor wiring
	Check that cable shields are grounded near the LCI-80x for best noise immunity.	Try variations on shield grounding. Try both ends or no grounding.
	Baseline noise – cannot be remedied	Adjust sample rate to reduce the effective noise.
Ground loop	Draw or review a schematic of the tension input sensor/LCI-80x connection to identify any ground loops.	Remove ground loop.

<b>Problem</b> No Outputs from Alarm Channels		
<b>Possible Causes</b>	<b>Diagnosis</b>	<b>Remedies</b>
Incorrect menu configuration	Check the alarm configuration in Menu 4.7 to make sure that the expected relay will be energized by the alarm condition. Each alarm must be programmed to output to Relay 1-4 to energize a relay.	Review manual Section 5.3 for alarm use and configuration

## **6.2 Technical support**

The resolution of technical problem should first be attempted using the Troubleshooting Guide or by reading the appropriate sections of the manual. If this fails, either contact the supplier from whom you purchased the display, or the manufacturer, for additional technical support. When seeking technical support, please fax or e-mail notes including a description of the problem, all relevant menu, DIP switch and jumper settings, any hardware options installed, plus a description of the field devices in use and how they are terminated on the LCI-80x.

Measurement Technology Northwest  
4211 24<sup>th</sup> Ave West  
Seattle, WA 98199 USA

Ph: (206) 634-1308

Fax: (206) 634-1308

e-mail: [LCI@mtnw-usa.com](mailto:LCI@mtnw-usa.com)

Office Hours: 8:30 AM to 5:30 PM - Pacific Time

### 7.0 Appendix A – Dimensional Drawing

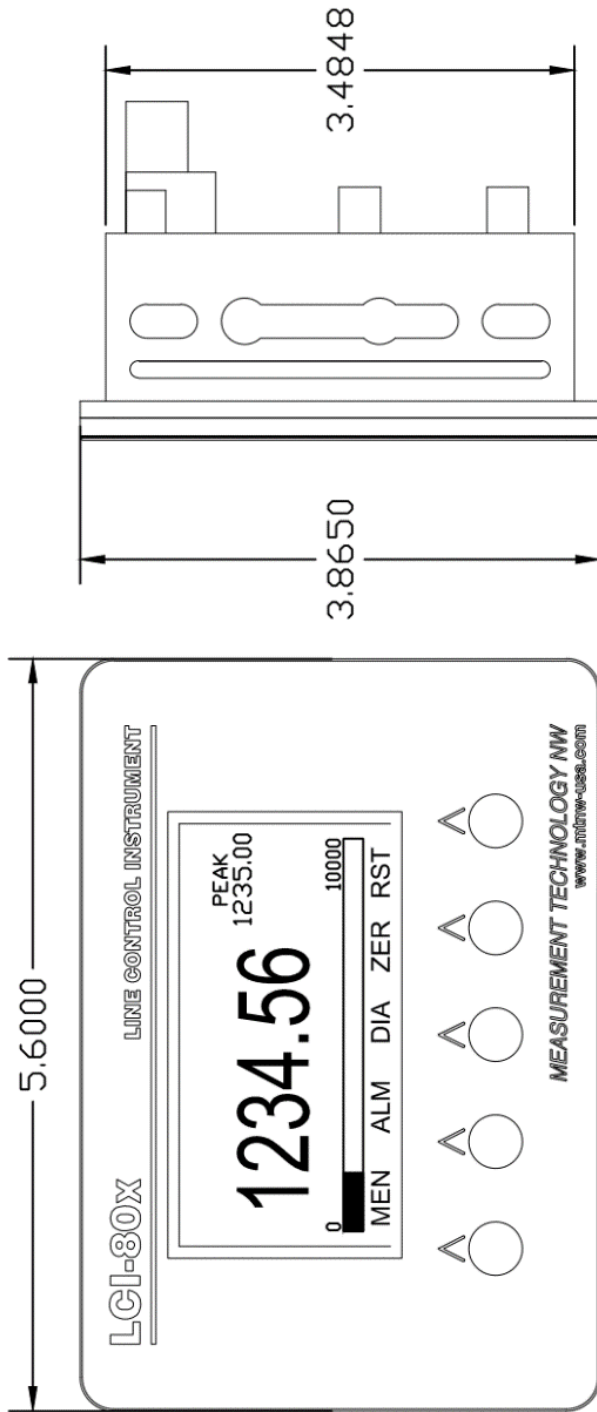

- NOTES:
- 1 RECOMMENDED CUTOUT 5.27 X 3.55
  - 2 ALL UNITS IN INCHES
  - 3 PANEL MOUNT CONFIGURATION SHOWN

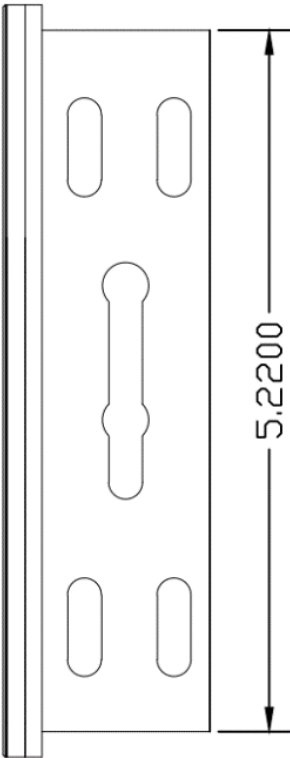

## 8.0 Appendix B – DIP Switch Settings

**Table 8.1 RS-485 Termination Settings**

<b>Function</b>	<b>SW3-1</b>	<b>SW3-2</b>
RS 485 Term OFF	OFF	OFF
RS 485 Term ON*	ON	ON

**Table 8.2 Analog Input Termination Settings**

<b>Sensor Config</b>	<b>OFF</b>	<b>ON</b>
AIN-1 [SW2-1]	High impedance input	220 $\Omega$ load resistor*
AIN-2 [SW2-2]	High impedance input	220 $\Omega$ load resistor*

\* Denotes factory default settings

## 9.0 Appendix C – LCI-80x Specifications

LCI-80x	PHYSICAL/POWER	Std/Option
<b>Temp.</b>	-40°C to 70°C	Std
<b>Environmental</b>	Weatherproof front panel (watertight when correctly mounted in existing panel)	Std
	Optional watertight rear enclosure	01
<b>Dimensions</b>	5.6" wide x 3.9" high x 2.5" deep	Std
	Cut out: 5.27" wide x 3.55" high	Std
<b>Weight</b>	1.7 pounds	Std
<b>Materials</b>	Stainless Steel 316 front panel	Std
	Polycarbonate display window	Std
	Silicone front panel gasket	Std
<b>Power</b>	9-36 VDC, 15W maximum, fused/filtered	Std

LCI-80x	DISPLAY	Std/Option
<b>Type</b>	Graphic electro-luminescent, 160 x 80 pixels	Std
<b>View Angle</b>	160 degrees	Std
<b>Viewing Area</b>	3.15" wide x 1.57" high	Std
<b>Brightness</b>	High brightness – 79 cd/m <sup>2</sup>	Std
<b>Contrast</b>	Adjustable	Std
<b>Characters</b>	6 digits for pressure and peak pressure	Std

LCI-80x	DIGITAL I/O – ALARMS	Std/Option
<b>Channels</b>	Two relay outputs	Std
<b>Type</b>	SPDT Normally open and Normally closed outputs 125VAC, 60VDC, 1A	Std

LCI-80x	SERIAL COMMUNICATION	Std/Option
<b>Type</b>	Ethernet Port	Std
	RS-232 Serial Port (non-isolated)	Std
	RS-485 Serial Port (isolated, half-duplex)	Std
<b>Baud Rate</b>	USB: USB2.0	Std
	RS-232: 230,400 baud	Std
	RS-485: 230,400 baud	Std
<b>Protection</b>	RS-485: 2500 V rms	Std

<b>LCI-80x</b>		<b>DIGITAL INPUT</b>	<b>Std/Option</b>
<b>Channels</b>	Two channels		Std
<b>Type</b>	CMOS input (trigger level is 2.5V)		Std
<b>Voltage Range</b>	0-60VDC		Std

## 10.0 Appendix D – LCI-80x Wire List

**Table 10.1 LCI-80x Wire List**

Function	Reference	Designator
+5 V <sub>DC</sub> Power Supply	Table 3.3	TB-1 [TB1]
+12 V <sub>DC</sub> Power Supply Output		TB-1 [TB2]
COUNTER-A	-	TB-1 [TB3]
COUNTER-B		TB-1 [TB4]
COM		TB-1 [TB5, TB6]
VIN+	Table 3.2	TB-2 [TB7, TB8]
COM		TB-2 [TB9, TB10]
DIGITAL IN-1	DIG I/O CONFIG	TB-2 [TB11]
DIGITAL IN-2	DIG I/O CONFIG	TB-2 [TB12]
DISPLAY DIM +	Display Configuration	TB-2 [TB13]
DISPLAY DIM -		TB-2 [TB14]
STRAIN GAUGE N+	Pressure Sensor Inputs	TB-3 [TB15]
STRAIN GAUGE V+		TB-3 [TB16]
STRAIN GAUGE S+		TB-3 [TB17]
STRAIN GAUGE S-		TB-3 [TB18]
STRAIN GAUGE V-		TB-3 [TB19]
STRAIN GAUGE N-		TB-3 [TB20]
RS-232 TX	Serial Communications	TB-4 [TB21]
RS-232 RX		TB-4 [TB22]
RS-232 COM		TB-4 [TB23]
RS-485 T-/R-	Serial Communications	TB-5 [TB24, TB25]
RS-485 SHIELD		TB-5 [TB26, TB27]
RS-485 T+/R+		TB-5 [TB28, TB29]
ANALOG INPUT 1+	Pressure Sensor Inputs	TB-6 [TB30]
ANALOG INPUT 1-		TB-6 [TB31]
ANALOG INPUT 2+		TB-6 [TB32]
ANALOG INPUT 2-		TB-6 [TB33]
+24 VDC Power Supply Output	Table 3.3	TB-6 [TB34, TB35]
ANALOG OUTPUT 1	Analog Outputs	TB-7 [TB36]
ANALOG OUTPUT 2		TB-7 [TB37]
RELAY 1 OUT NC	Configuring Alarms	TB-8 [TB40]
RELAY 1 OUT C		TB-8 [TB41]
RELAY 1 OUT NO		TB-8 [TB42]
RELAY 2 OUT NC		TB-8 [TB43]
RELAY 2 OUT C		TB-8 [TB44]
RELAY 2 OUT NO		TB-8 [TB45]

### 11.0 Appendix E – LCI-80x Terminal Board Interface

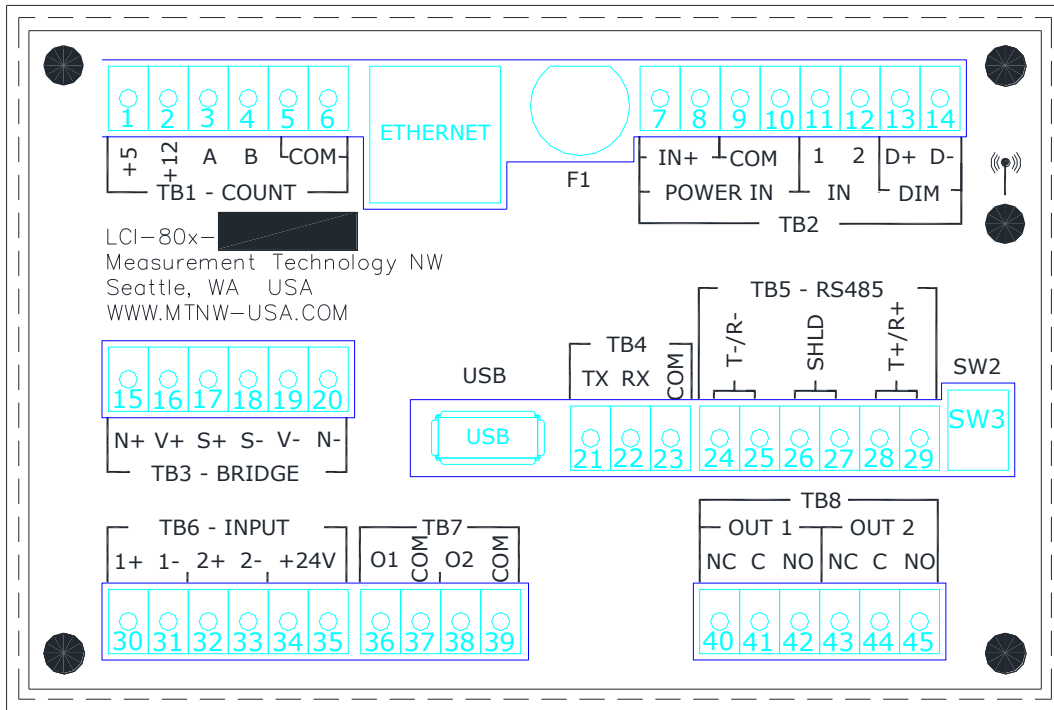

Figure 11.1 LCI-80x Terminal Board Interface



## 12.0 Appendix F – LCI-80x Gimbal Bracket Mounting Footprint

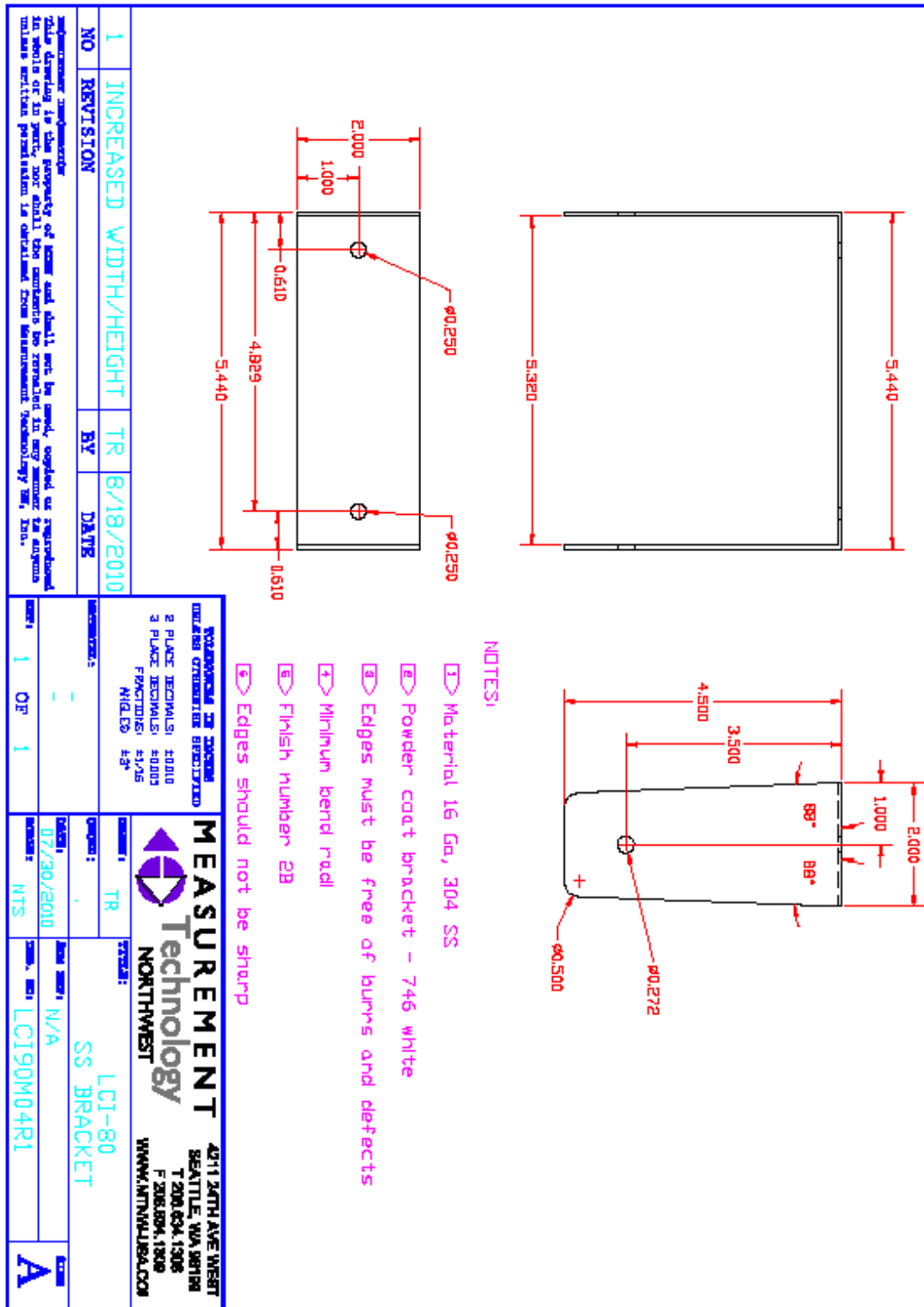

Figure 12.1 LCI-80x Gimbal Bracket Dimensions