

EH1721, BIH1721 & FPH1721 Series



EH1721 Series Electric Fryers
Installation & Operation Manual

 **Frymaster**[®]

NON-CE &



CFESA
Commercial Food Equipment Service Association

Frymaster, a member of the Commercial Food Equipment Service Association, recommends using CFESA Certified Technicians.

PRINTED IN
THE UNITED
STATES

24 Hour Service Hotline 1-800-551-8633

Email: service@frymaster.com

www.frymaster.com

8195713

APRIL 2005

Please read all sections of this manual and retain for future reference.

NOTICE

IF, DURING THE WARRANTY PERIOD, THE CUSTOMER USES A PART FOR THIS ENODIS EQUIPMENT OTHER THAN AN UNMODIFIED NEW OR RECYCLED PART PURCHASED DIRECTLY FROM FRYMASTER DEAN, OR ANY OF ITS AUTHORIZED SERVICE CENTERS, AND/OR THE PART BEING USED IS MODIFIED FROM ITS ORIGINAL CONFIGURATION, THIS WARRANTY WILL BE VOID. FURTHER, FRYMASTER DEAN AND ITS AFFILIATES WILL NOT BE LIABLE FOR ANY CLAIMS, DAMAGES OR EXPENSES INCURRED BY THE CUSTOMER WHICH ARISE DIRECTLY OR INDIRECTLY, IN WHOLE OR IN PART, DUE TO THE INSTALLATION OF ANY MODIFIED PART AND/OR PART RECEIVED FROM AN UNAUTHORIZED SERVICE CENTER.

NOTICE

This appliance is intended for professional use only and is to be operated by qualified personnel only. A Frymaster Dean Factory Authorized Service Center (FASC) or other qualified professional should perform installation, maintenance, and repairs. Installation, maintenance, or repairs by unqualified personnel may void the manufacturer's warranty. See Chapter 1 of this manual for definitions of qualified personnel.

NOTICE

This equipment must be installed in accordance with the appropriate national and local codes of the country and/or region in which the appliance is installed.

NOTICE

Drawings and photos used in this manual are intended to illustrate operational, cleaning and technical procedures and may not conform to onsite management operational procedures.

NOTICE TO OWNERS OF UNITS EQUIPPED WITH COMPUTERS

U.S.

This device complies with Part 15 of the FCC rules. Operation is subject to the following two conditions: 1) This device may not cause harmful interference, and 2) This device must accept any interference received, including interference that may cause undesired operation. While this device is a verified Class A device, it has been shown to meet Class B limits.

CANADA

This digital apparatus does not exceed the Class A or B limits for radio noise emissions as set out by the ICES-003 standard of the Canadian Department of Communications.

Cet appareil numérique n'émet pas de bruits radioélectriques dépassant les limites de classe A et B prescrites dans la norme NMB-003 édictée par le Ministre des Communications du Canada.

 DANGER

Improper installation, adjustment, maintenance or service, and unauthorized alterations or modifications can cause property damage, injury, or death. Read the installation, operating and service instructions thoroughly before installing or servicing this equipment. See Chapter 1 of this manual for definition of qualified service personnel.

 **DANGER**

The front ledge of the fryer is not a step. Do not stand on the fryer. Serious injury can result from slips or contact with the hot oil.

 **DANGER**

Single fryers equipped with legs must be stabilized by installing anchor straps. All fryers equipped with casters must be stabilized by installing restraining chains

 **DANGER**

Do not store or use gasoline or other flammable vapors and liquids in the vicinity of this or any other appliance.

 **DANGER**

The crumb tray in fryers equipped with a filter system must be emptied into a fireproof container at the end of frying operations each day. Some food particles can spontaneously combust if left soaking in certain shortening material. Additional information can be obtained in the filtration manual included with the system.

 **WARNING**

No structural material on the fryer should be altered or removed to accommodate placement of the fryer under a hood. Questions? Call the Frymaster Dean Service Hotline at 1-800-551-8633.

 **WARNING**

Do not bang fry baskets or other utensils on the fryer's joiner strip. The strip is present to seal the joint between the frypot. Banging fry baskets on the strip to dislodge shortening will distort the strip, adversely affecting its fit. It is designed for a tight fit and should only be removed for cleaning.

 **DANGER**

Adequate means must be provided to limit the movement of this appliance without depending on or transmitting stress to the electrical conduit. A restraint kit is provided with the fryer. If the restraint kit is missing contact your local Frymaster Factory Authorized Service Center (FASC) for part number 826-0900.

 **DANGER**

This fryer may have two power cords and prior to movement, testing, maintenance and any repair on your Frymaster fryer; disconnect BOTH electrical power cords from the electrical power supply.



**EH1721 SERIES ELECTRIC FRYERS
INSTALLATION & OPERATION MANUAL**

TABLE OF CONTENTS

	Page #
1. INTRODUCTION	1-1
1.1 General	1-1
1.2 Safety Information	1-1
1.3 Computer Information	1-2
1.4 Shipping Damage Claim Procedure	1-2
1.5 Service Information	1-3
2. INSTALLATION INSTRUCTIONS	2-1
2.1 General	2-2
2.2 Fryer Installation	2-4
2.3 Power Requirements	2-5
2.4 Frypot Boil-Out	2-6
2.5 Equipment Setup and Shutdown Procedures	2-7
3. PREVENTATIVE MAINTENANCE	3-1
3.1 Cleaning Fryer	3-1
3.1 Periodic/Annual Maintenance	3-3
3.1 Stainless Steel Care	3-4
4. UNDER-FRYER-FILTER (UFF) FILTRATION	4-1
4.1 Filter Preparation	4-1
4.2 Daily Filtration Operation	4-2
4.3 Operating the Filter	4-3
5. OPERATOR TROUBLESHOOTING	5-1
5.1 Introduction	5-1
5.2 Troubleshooting	5-2
5.3 Recommended Spare Parts	5-7

EH1721 SERIES ELECTRIC FRYERS

CHAPTER 1: INTRODUCTION

1.1 General

Read the instructions in this manual thoroughly before attempting to operate this equipment. This manual covers all EH1721 Series electric fryers.

EH1721 Series electric fryers feature easy to clean, open frypots with tilt-up elements. The fryers are controlled by multi-product cooking computers and come in full-pot configurations.

1.2 Safety Information

Before attempting to operate your unit, read the instructions in this manual thoroughly.

Throughout this manual, you will find notations enclosed in double-bordered boxes similar to the ones below.

 **CAUTION**

CAUTION boxes contain information about actions or conditions that *may cause or result in a malfunction of your system.*

 **WARNING**

WARNING boxes contain information about actions or conditions that *may cause or result in damage to your system,* and which may cause your system to malfunction.

 **DANGER**

DANGER boxes contain information about actions or conditions that *may cause or result in injury to personnel,* and which may cause damage to your system and/or cause your system to malfunction.

Fryers in this series are equipped with automatic safety features:

1. Two high-temperature detection features shut off power to the elements should the temperature controls fail.
2. An inline circuit breaker shuts off power to the filter-pump motor (if equipped) if the motor clogs or overheats.

EH1721 SERIES ELECTRIC FRYERS CHAPTER 1: INTRODUCTION

1.3 Computer Information

This equipment has been tested and found to comply with the limits for a Class A digital device, pursuant to Part 15 of the FCC rules. While this device is a verified Class A device, it has been shown to meet the Class B limits. These limits are designed to provide reasonable protection against harmful interference when the equipment is operated in a commercial environment. This equipment generates, uses and can radiate radio frequency energy and, if not installed and used in accordance with the instruction manual, may cause harmful interference to radio communications. Operation of the equipment in a residential area is likely to cause harmful interference in which case the user will be required to correct the interference at their own expense.

The user is cautioned that any changes or modifications not expressly approved by the party responsible for compliance could void the user's authority to operate the equipment.

If necessary, the user should consult the dealer or an experienced radio and television technician for additional suggestions.

The user may find the following booklet prepared by the Federal Communications Commission helpful: "How to Identify and Resolve Radio-TV Interference Problems". This booklet is available from the U.S. Government Printing Office, Washington, DC 20402, Stock No. 004-000-00345-4.

1.4 Shipping Damage Claim Procedure

What to do if your equipment arrives damaged:

Please note that this equipment was carefully inspected and packed by skilled personnel before leaving the factory. The freight company assumes full responsibility for safe delivery upon acceptance of the equipment.

1. File Claim for Damages Immediately—Regardless of extent of damage.
2. Visible Loss or Damage—Be sure this is noted on the freight bill or express receipt and is signed by the person making the delivery.
3. Concealed Loss or Damage—If damage is unnoticed until equipment is unpacked, notify the freight company or carrier immediately and file a concealed damage claim. This should be done within 15 days of date of delivery. Be sure to retain container for inspection.

**EH1721 SERIES ELECTRIC FRYERS
CHAPTER 1: INTRODUCTION**

1.5 Service Information

For non-routine maintenance or repairs, or for service information, contact your local Frymaster Authorized Service Center (FASC). Service information may also be obtained by calling the Frymaster Technical Services Department (1-800-551-8633). The following information will be needed in order to assist you efficiently:

Model Number _____

Serial Number _____

Voltage _____

Nature of the Problem _____

1.6 After Purchase

In order to improve service, have the following chart filled in by the Frymaster Dean Authorized Service Technician who installed this equipment.

Authorized Service Technician/FASC	_____
Address	_____

Telephone/Fax	_____
Model Number	_____
Serial Number	_____
Gas Type	_____

1.7 SERVICE PERSONNEL

1.7.1 Definitions

A. Qualified and/or Authorized Operating Personnel

1. Qualified/authorized operating personnel are those who have carefully read the information in this manual and have familiarized themselves with the equipment functions, or have had previous experience with the operation of equipment covered in this manual.

B. Qualified Installation Personnel

1. Qualified installation personnel are individuals, or firms, corporations, or companies that, either in person or through a representative, are engaged in and are responsible for the installation of electrical appliances. Qualified personnel must be experienced in such work, be familiar with all electrical precautions involved, and have complied with all requirements of applicable national and local codes.

C. Qualified Service Personnel

1. Qualified service personnel are those who are familiar with Frymaster Dean equipment and have been authorized by Frymaster Dean to perform service on Frymaster Dean equipment. All authorized service personnel are required to be equipped with a complete set of service parts manuals and stock a minimum amount of parts for Frymaster Dean equipment. A list of Frymaster Dean Factory Authorized Service Centers (FASCs) was included with the fryer when shipped from the factory. ***Failure to use qualified service personnel will void the Frymaster Dean warranty on your equipment.***

RETAIN AND STORE THIS MANUAL IN A SAFE PLACE FOR FUTURE USE.

EH1721 SERIES ELECTRIC FRYERS

CHAPTER 2: INSTALLATION INSTRUCTIONS

FINDING YOUR WAY AROUND THE EH1721 SERIES ELECTRIC FRYER

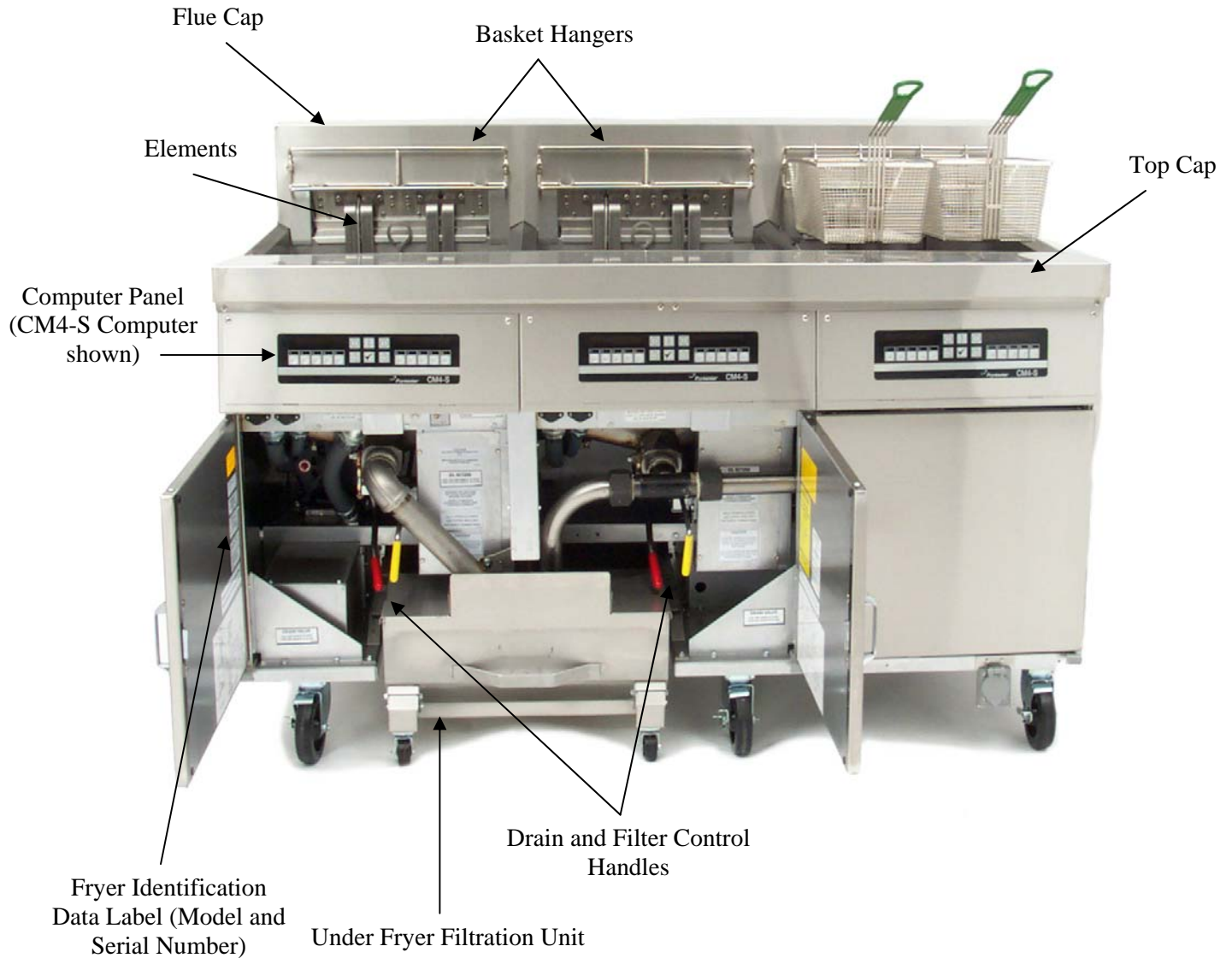

TYPICAL CONFIGURATION (FPH31721 SHOWN)

NOTE: The appearance of your fryer may differ slightly from that shown depending upon configuration and date of manufacture.

**EH1721 SERIES ELECTRIC FRYERS
CHAPTER 2: INSTALLATION INSTRUCTIONS**

2.1 General

Proper installation is essential for the safe, efficient, trouble-free operation of this appliance.

Qualified, licensed, and/or authorized installation or service personnel, as defined in Section 1.7 of this manual, should perform all installation and service on Frymaster equipment.

Failure to use qualified, licensed, and/or authorized installation or service personnel (as defined in Section 1.7 of this manual) to install or otherwise service this equipment will void the Frymaster warranty and may result in damage to the equipment or injury to personnel.

Where conflicts exist between instructions and information in this manual and local or national codes or regulations, installation and operation shall comply with the codes or regulations in force in the country in which the equipment is installed.

Service may be obtained by contacting your local Factory Authorized Service Center.

NOTICE

All fryers shipped without factory supplied cords and plug assemblies must be hardwired using flexible conduit to the terminal block located on the rear of the fryer. These fryers should be wired to NEC specifications. Hardwired units must include installation of restraint devices.

 DANGER

Adequate means must be provided to limit the movement of this appliance without depending on or transmitting stress to the electrical conduit. A restraint kit is provided with the fryer. If the restraint kit is missing contact your local Frymaster Factory Authorized Service Center (FASC) for part number 826-0900.

NOTICE

If this equipment is wired directly into the electrical power supply, a means for disconnection from the supply having a contact separation of at least 3-mm in all poles must be incorporated in the fixed wiring.

NOTICE

This equipment must be positioned so that the plug is accessible unless other means for disconnection from the power supply (e.g., a circuit breaker) is provided.

 DANGER

The electrical power supply for this appliance **MUST** be the same as indicated on the rating and serial number plate located on the inside of the fryer door.

NOTICE

If this appliance is permanently connected to fixed wiring, it **MUST** be connected by means of copper wires having a temperature rating of not less than 167°F (75°C).

EH1721 SERIES ELECTRIC FRYERS CHAPTER 2: INSTALLATION INSTRUCTIONS

NOTICE

If the electrical power supply cord is damaged, it must be replaced by a Frymaster Dean Factory Authorized Service Center technician or a similarly qualified person in order to avoid a hazard.

DANGER

This appliance must be connected to a power supply having the same voltage and phase as specified on the rating plate located on the inside of the appliance door.

DANGER

All wiring connections for this appliance must be made in accordance with the wiring diagram(s) furnished with the appliance. Refer to the wiring diagram(s) affixed to the inside of the appliance door when installing or servicing this equipment.

DANGER

Frymaster appliances equipped with legs are for stationary installations. Appliances fitted with legs must be lifted during movement to avoid damage to the appliance and bodily injury. For movable installations, optional equipment casters must be used. Questions? Call 1-800-551-8633.

WARNING

Do not attach an apron drainboard to a single fryer. The fryer may become unstable, tip over and cause injury. The appliance area must be kept free and clear of combustible material at all times.

In the event of a power failure, the fryer(s) will automatically shut down. If this occurs, turn the power switch "OFF". Do not attempt to start the fryer(s) until power is restored.

This appliance must be kept free and clear of combustible material, except that it may be installed on combustible floors.

A clearance of 6 inches (15 cm) must be provided at both sides and back adjacent to combustible construction. A minimum of 24 inches (61cm) should be provided at the front of the equipment for servicing and proper operation.

WARNING

Do not block the area around the base or under the fryers.

2.1.2 Electrical Grounding Requirements

All electrically operated appliances must be grounded in accordance with all applicable national and local codes, and, where applicable, CE codes. A wiring diagram is located on the inside of the fryer door. Refer to the rating plate on the inside of the fryer door for proper voltages.

EH1721 SERIES ELECTRIC FRYERS
CHAPTER 2: INSTALLATION INSTRUCTIONS

2.1.3 Australian Requirements

To be installed in accordance with AS 5601 / AG 601, local authority, gas, electricity, and any other relevant statutory regulations.

2.2 Fryer Installation

 **WARNING**

Frymaster fryers equipped with legs are for permanent installations. Fryers fitted with legs must be lifted during movement to avoid damage and possible bodily injury. For a moveable or portable installation, Frymaster optional equipment casters must be used. Questions? Call 1-800-551-8633

1. To level fryers equipped with legs, the bottom of the legs can be screwed out up to 1-inch for leveling. Legs should be adjusted so that the fryer is at the proper height in the frying station. For fryers equipped with casters, there are no built-in leveling devices. The floor where the fryer is installed must be level.

NOTE: If you need to relocate a fryer installed with legs, remove all the weight from each leg before moving. If a leg becomes damaged, contact your service agent for immediate repair or replacement.

 **WARNING**

Hot shortening can cause severe burns. Avoid contact. Under all circumstances, oil must be removed from the fryer before attempting to move it to avoid oil spills and the falls and severe burns that could occur. This fryer may tip and cause personal injury if not secured in a stationary position.

2. When the fryer is leveled in its final position, install the restraints provided with the unit to limit its movement so that it does not depend on or transmit stress to the electrical conduit or connection as well as to prevent tipping. Install the restraints in accordance with the provided instructions (see illustration on the following page). If the restraints are disconnected for service or other reasons, they **MUST** be reconnected before the fryer is used.

 **DANGER**

Adequate means must be provided to limit the movement of this appliance without depending on or transmitting stress to the electrical conduit. A restraint kit is provided with the fryer. If the restraint kit is missing contact your local Frymaster Factory Authorized Service Center (FASC) for part number 826-0900.

EH1721 SERIES ELECTRIC FRYERS

CHAPTER 2: INSTALLATION INSTRUCTIONS

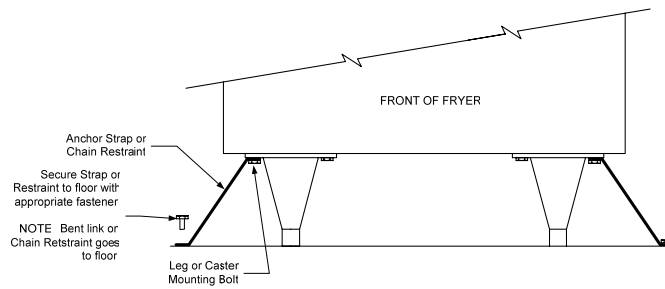

3. Close fryer drain-valve and fill frypot with water to the bottom OIL LEVEL line.
4. Boil out frypot prior to first use. See Frypot Boil-Out instructions in Section 2.4.
5. Drain, clean, and fill frypot(s) with cooking oil. See Section 2.5, Equipment Setup and Shutdown Procedures.

2.3 Power Requirements

⚠ DANGER
Copper wire suitable for at least 167°F (75°C) MUST be used for power connections.

MODEL	VOLTAGE	PHASE	WIRE SERVICE	MIN. SIZE	AWG (mm ²)	AMPS PER LEG		
						L1	L2	L3
17 kW	208	3	3	6	(16)	48	48	48
17 kW	240	3	3	6	(16)	41	41	41
17 kW	480	3	3	6	(16)	21	21	21
17 kW	220/380	3	4	6	(16)	26	26	26
17 kW	240/415	3	4	6	(16)	24	24	24
17 kW	230/400	3	4	6	(16)	25	25	25
21 kW	208	3	3	4	(25)	58	58	58
21 kW	240	3	3	4	(25)	51	51	51
21 kW	480	3	3	6	(16)	25	25	25
21 kW	220/380	3	4	6	(16)	32	32	32
21 kW	240/415	3	4	6	(16)	29	29	29
21 kW	230/400	3	4	6	(16)	30	30	30

⚠ DANGER

The electrical power supply for this appliance MUST be the same as indicated on the rating and serial number plate located on the inside of the fryer door.

⚠ DANGER

This appliance MUST be connected to the voltage and phase specified on the rating and serial number plate located inside the fryer door.

⚠ DANGER

All wiring connections for this appliance MUST be made in accordance with the wiring diagrams furnished with the equipment. Wiring diagrams are located inside the fryer door.

EH1721 SERIES ELECTRIC FRYERS
CHAPTER 2: INSTALLATION INSTRUCTIONS

2.4 Frypot Boil Out

Before the fryer is first used for cooking product, it should be boiled out to ensure that residue from the manufacturing process has been eliminated.

Also, after the fryer has been in use for a period of time, a hard film of caramelized oil will form inside the frypot. This film should be periodically removed by following the boil-out procedure.

Clean frypot(s) as follows before filling with oil for the first time and at least once a month thereafter:

1. Before switching the fryer "ON", close the frypot drain valve, then fill the empty frypot with a mixture of cold water and detergent. Follow instructions on detergent bottle when mixing.
2. Press computer ON/OFF switch to "ON".
3. Program computer for Boil-out Operation as outlined in the computer manual that shipped with the fryer.
4. Simmer the solution for 45 minutes to 1 hour. Do not allow water level to drop below the bottom OIL LEVEL line in frypot during boil-out operation.

 **CAUTION**

Do not leave fryer unattended. The boil-out solution may foam and overflow. Press ON/OFF switch to the "OFF" position to control boil over.

 **CAUTION**

All drops of water MUST be removed from frypot before filling with oil.

 **CAUTION**

Water or boil-out solution MUST not be allowed to drain into the filter pan or filter system. Irreversible damage will result if water is allowed into the filtration system and all applicable warranties will be voided.

5. Turn the fryer ON/OFF switch(s) to the "OFF" position.
6. Add two gallons of water. Drain out the solution and clean the frypot(s) thoroughly.
7. Refill the frypot(s) with clean water. Rinse the frypot(s) twice, drain and wipe down with a clean towel. Remove all traces of water prior to filling frypot with oil.

For computer/controller operational procedures, consult the manual that shipped with the computer/controller.

EH1721 SERIES ELECTRIC FRYERS
CHAPTER 2: INSTALLATION INSTRUCTIONS

2.5 Equipment Setup and Shutdown Procedures

Setup

⚠ WARNING

Fill the frypot to the bottom OIL LEVEL line with oil before pressing the ON/OFF switch  to the "ON" position. Failure to do so could damage the frypot and elements.

1. Fill the frypot with oil to the bottom OIL LEVEL line located on the rear of the frypot. This will allow for oil expansion as heat is applied. Do not fill cold oil any higher than the bottom line; overflow may occur as heat expands the oil. If solid shortening is used, first raise the elements, then pack solid shortening into the bottom of the frypot. Lower the elements, and then pack solid shortening around and over the elements. **Never** insert a solid block of shortening into frypot on top of the elements. Hot spots and element damage will occur, and the potential for flash-fire increases.

⚠ WARNING

NEVER set a complete block of solid shortening on top of heating elements. To do so will damage the elements and increase the potential for flash-point shortening temperatures and subsequent fire.

2. Ensure that the power cord(s) is/are plugged into the appropriate receptacle(s). Verify that the face of the plug is flush with the outlet plate, with no portion of the prongs visible.
3. Ensure that the oil level is at the *top* OIL LEVEL line when the oil *is at its programmed cooking temperature*. It may be necessary to add oil to bring the level up to the proper mark, *after the oil has reached the programmed cooking temperature*. If solid shortening is used, the MELT cycle **MUST** be used exclusively to melt the shortening. It may be necessary to add solid shortening to bring the level up to the proper mark after the packed shortening has melted. **DO NOT DISABLE OR CANCEL THE MELT CYCLE.**

Shutdown

1. Press the ON/OFF switch  to the "OFF" position. (The display will show "OFF" if the CM4-S computer is used. If using a CMIII.5, the display will be blank.)
2. Filter oil (if applicable) and clean fryers (See Chapter 3).
3. Place the frypot covers on frypots.

EH1721 SERIES ELECTRIC FRYERS

CHAPTER 3: PREVENTATIVE MAINTENANCE

3.1 Cleaning Fryer

3.1.1 Clean Inside and Outside of Fryer Cabinet— Daily

1. Clean inside the fryer cabinet with a dry, clean cloth. Wipe all accessible metal surfaces and components to remove accumulated oil and dust.
2. Clean outside the fryer cabinet, with a clean, damp cloth soaked with dishwashing detergent. Wipe with a clean, damp cloth.

3.1.2 Clean Frypot and Heating Elements— Weekly

 **WARNING**
NEVER operate the fryer(s) with an empty frypot. Irreparable damage to the heating elements will result.

Boiling Out the Frypot:

See Section 2.4 for boil-out procedure. For computer/controller operational procedures, consult the manual that shipped with the computer/controller.

 **WARNING**
DO NOT leave the fryer unattended during the boil-out process. If the solution foams excessively and overflows, press the ON/OFF switch to the "OFF" position immediately. Allow solution to settle, and then continue with the boil-out process.

 **WARNING**
Do not run water or boil-out solution through the filtration system. Doing so will cause irreparable damage to the pump and all applicable warranties will be voided.

3.1.3 Clean Detachable Parts and Accessories— Weekly

Wipe all detachable parts and accessories with a clean, dry cloth. Use a clean cloth saturated with detergent to remove accumulated carbonized oil on detachable parts and accessories. Rinse the parts and accessories thoroughly with clean water and wipe dry before reinstalling.

**EH1721 SERIES ELECTRIC FRYERS
CHAPTER 3: PREVENTATIVE MAINTENANCE**

3.1.4 Draining and Manual Filtering: Non-Filtration Fryers

 **DANGER**

Allow oil to cool to 100°F (38°C) or lower before draining into an appropriate container for disposal.

If your fryer is not equipped with a built-in filtration system [Under Fryer Filter (UFF)], the oil must be drained into another suitable container. (For safe, convenient draining and disposal of used oil or shortening, Frymaster recommends using the Frymaster *Shortening Disposal Unit* (SDU). The SDU is available through your local distributor.)

1. Turn the fryer power switch to the "OFF" position. Screw the drainpipe (provided with your fryer) into the drain valve. Make sure the drainpipe is firmly screwed into the drain valve and that the opening is pointing down.
2. Position a metal container under the drainpipe. The metal container must be able to withstand the heat of the oil and have a sealing lid. If you intend to reuse the oil, Frymaster recommends that a Frymaster filter cone holder and filter cone be used when a filter machine is not available. If you are using a Frymaster filter cone holder, be sure that the cone holder rests securely on the metal container.
3. Open the drain valve slowly to avoid splattering. If the drain valve becomes clogged with food particles, use the Fryer's Friend (clean-out rod) to clear the blockage.

 **DANGER**

DO NOT insert anything into the drain from the front to unclog the valve. Hot oil will rush out, creating an extreme hazard.

 **WARNING**

DO NOT hammer on the drain valve with the Fryer's Friend. This will damage the drain valve ball and prevent the valve from sealing securely, resulting in a leaky valve.

4. After draining the oil, clean all food particles and residual oil from the frypot. BE CAREFUL, this material may still cause severe burns if it comes in contact with bare skin.
5. Close the drain valve securely and fill the frypot with clean, filtered or fresh oil or solid shortening to the bottom OIL LEVEL line.

For frying systems with built-in filtration, see Chapter 4 for detailed operational procedures.

EH1721 SERIES ELECTRIC FRYERS
CHAPTER 3: PREVENTATIVE MAINTENANCE

3.2 Periodic/Annual Maintenance

Frymaster recommends that the fryer be inspected annually by a Factory Authorized Service Technician for the following checks and adjustments:

- Inspect the cabinet inside and out, front and rear for excessive oil build-up and/or oil migration.
- Verify that the heating element wires are in good condition and that leads have no visible fraying or insulation damage and that they are free of oil migration build-up.
- Verify that heating elements are in good condition with no carbon/caramelized oil build-up. Inspect the elements for signs of extensive dry-firing.
- Verify that the tilt mechanism is working properly when lifting and lowering elements and that the element wires are not binding and/or chafing.
- Verify the heating-element amp-draw is within the allowed range as indicated on the appliance's rating plate.
- Verify that the temperature and high-limit probes are properly connected, tightened and functioning properly, and that the mounting hardware and probe guard is present and properly installed.
- Verify that component box and contactor box components (i.e. computer/controller, relays, interface boards, transformers, contactors, etc.) are in good condition and free from oil migration build-up and other debris.
- Verify that component box and contactor box wiring connections are tight and that wiring is in good condition.
- Verify that all safety features (i.e. contactor shields, drain safety switches, reset switches, etc.) are present and functioning properly.
- Verify that the frypot is in good condition and free of leaks and that the frypot insulation is in serviceable condition.
- Verify that all wiring harnesses and connections are tight and in good condition.

Built-in Filtration:

- Inspect all oil-return and drain lines for leaks and verify that all connections are tight.
- Inspect the filter pan for leaks and cleanliness. If there is a large accumulation of crumbs in the crumb basket, advise the owner/operator that the crumb basket should be emptied into a fireproof container and cleaned daily.
- Verify that all O-rings and seals (including those on quick-disconnect fittings) are present and in good condition. Replace O-rings and seals if worn or damaged.

EH1721 SERIES ELECTRIC FRYERS
CHAPTER 3: PREVENTATIVE MAINTENANCE

3.2 Periodic/Annual Maintenance (cont.)

- Check filtration system integrity as follows:
 - With the filter pan empty, place each oil return handle, one at a time, in the ON position. Verify that the pump activates and that bubbles appear in the oil of the associated frypot.
 - Close all oil return valves (i.e., place all oil return handles in the OFF position). Verify proper functioning of each oil return valve by activating the filter pump using the lever on one of the oil return handle microswitches. No air bubbles should be visible in any frypot.
 - Verify that the filter pan is properly prepared for filtering, then drain a frypot of oil heated to 350°F (177°C) into the filter pan and close the frypot drain valve. Place the oil return handle in the ON position. Allow all oil to return to the frypot (indicated by bubbles in the oil). Return the oil return handle to the OFF position. The frypot should refill in no more than 2 minutes and 30 seconds.

To ensure good fryer health and a safe environment, the fryer should be checked and adjusted periodically by qualified service personnel as part of a regular kitchen maintenance program.

3.3 Stainless Steel Care

All stainless steel fryer outer parts should be wiped regularly with hot, soapy water during the day and with a liquid cleaner designed for this material at the end of each day.

Do not use steel wool, abrasive cloths, cleansers or powders!

Do not use a metal knife, spatula or any other metal tool to scrape stainless steel! Scratches are almost impossible to remove.

If it is necessary to scrape the stainless steel to remove any encrusted materials, soak the area first to loosen the material, then use a wood or nylon scraper only.

EH1721 SERIES ELECTRIC FRYERS

CHAPTER 4: BUILT-IN FILTRATION

4.1 Filtration Preparation

On initial installation and before each use, remove all loose parts from the filter, wash the filter pan and all accessories in hot, soapy water and dry thoroughly.

4.1.1 Assembling the Filter

The Single Under Fryer/Under Fryer Filter (SUFF/UFF) uses filter paper held in place by a hold-down ring to filter impurities and debris from the cooking medium. The filter pan is assembled with the following components (see illustration below):

1. Filter pan.
2. Filter support grid.
3. Filter paper.
4. Hold-down ring.
5. Crumb screen.
6. Front pan cover.
7. Rear pan cover.

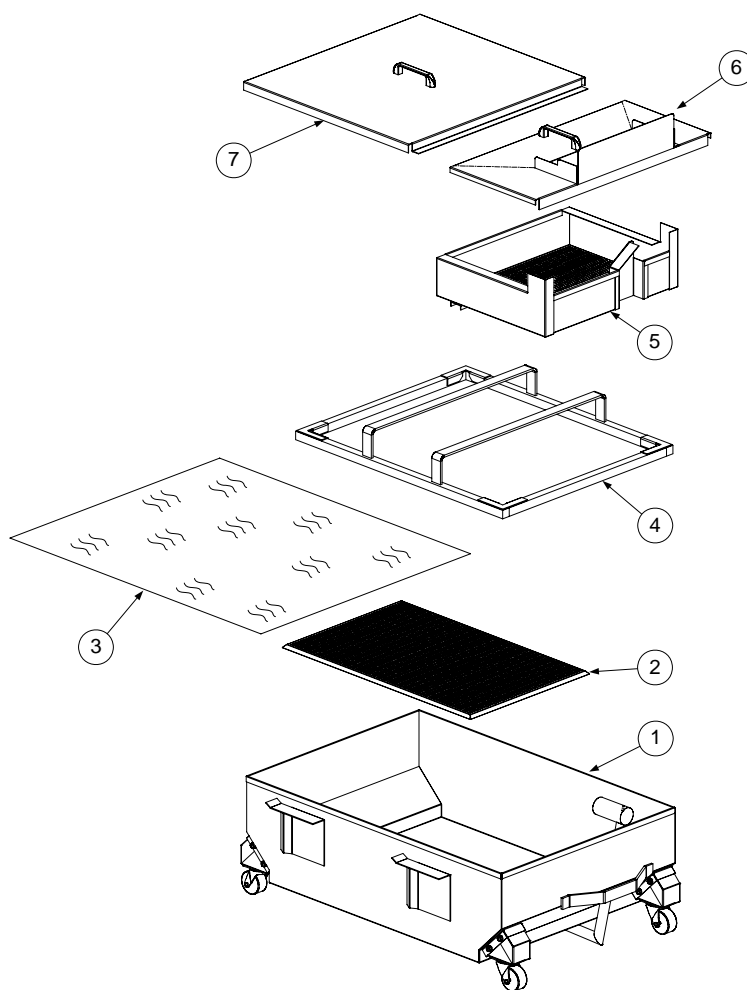

EH1721 SERIES ELECTRIC FRYERS CHAPTER 4: BUILT-IN FILTRATION

4.2 Daily Filtration Operation

 **WARNING**

Use caution and wear proper protective clothing. The oil to be filtered is at or near 350°F (177°C). Ensure all hoses are connected properly and drain handles are in their proper position prior to operating any switches or valves. Failure to do this can result in severe burns.

 **WARNING**

Drawings and photos used in this manual are intended to illustrate operational, cleaning and technical procedures and may not conform to on-site management operational procedures.

4.2.1 General Overview

The filter pump is turned on only after the oil is brought to operating temperature and drained into the prepared filter pan. The filter motor is then engaged and oil is drawn through filter paper and pumped back into the frypot. The frypot drain valve remains open during the filtering process. Allow the oil to cycle through the filter paper for approximately 5 minutes. At the end of 5 minutes, close the drain valve and allow the pump to fill the frypot to the bottom OIL LEVEL line. Leave the pump running for ten to fifteen seconds after bubbles appear in the frypot to ensure all oil is pumped from the drain pan and the lines.

4.2.2 Filtering Tools

Assemble tools to be used for filtering. These are supplied with the filter starter kit included with the fryer/filter system:

- Frypot/Filter Brush - used to clean frypot and filter pan sides and bottom, heating elements, and to dislodge sediment during filtration or oil change.
- Clean-Out Rod (design may vary)- used to dislodge heavy debris in the drain tube (when needed).
- Filter Powder.
- Filter Paper.

EH1721 SERIES ELECTRIC FRYERS

CHAPTER 4: BUILT-IN FILTRATION

4.2.2 Filtering Tools

The following tools are not required, but are recommended to make the filtering task easier.

- Measuring Cup — used to measure filter powder.
- Stainless Steel Crumb Scoop — for removing large debris.

Note: Always wear oil-resistant, insulated gloves and/or protective gear when working with hot oil.

4.3 Operating the Filter

4.3.1 Pan Preparation

1. Pull the filter pan outward until the slip fitting disconnects. Allow any residual oil left in the fittings to drip into the pan. Remove the filter pan from fryer cabinet. Use caution and wear protective gear.



Pull the filter pan from the fryer cabinet.

2. Remove both pan covers from the pan.



Pan covers removed from the pan.

EH1721 SERIES ELECTRIC FRYERS CHAPTER 4: BUILT-IN FILTRATION

4.3.1 Pan Preparation (cont.)

3. Remove the crumb screen, hold-down ring and filter paper from pan. Lift the support grid, remove and set aside. Clean all components in hot, soapy water and dry thoroughly. Clean the pan and sump, ensuring the air hole in the pickup (suction) tube is clear of debris.

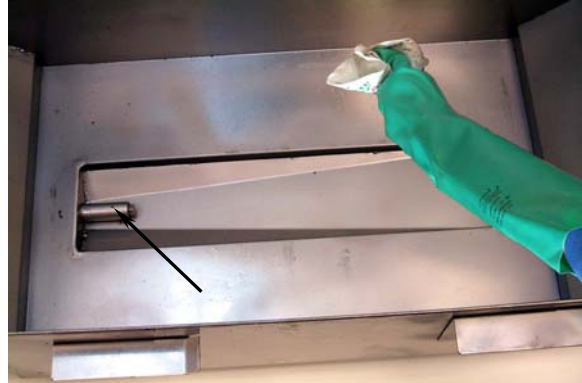

Clean the pan thoroughly after removing crumb screen, hold-down ring, filter paper and support grid. Ensure the air hole in the suction tube is free of debris (arrow).

4. Replace the support grid in pan bottom, ensuring both the grid and filter pan is free of water.



Cleaned support grid in place.

5. Place the filter paper over top of pan.



Place the filter paper over the top of filter pan, and then seat the paper with the hold-down ring.

EH1721 SERIES ELECTRIC FRYERS CHAPTER 4: BUILT-IN FILTRATION

4.3.1 Pan Preparation (cont.)

6. Seat the filter paper with the hold-down ring, ensuring that the paper extends beyond all sides of the hold-down ring.



Filter paper properly seated under the hold-down ring. Note that the paper extends beyond hold-down ring on all sides.

7. Sprinkle 8 ounces of filter powder evenly over the surface of the filter paper.



Applying filter powder to filter paper.

8. Inspect the O-rings on slip fittings and replace them if worn or damaged.

Ensure that the O-rings (arrow) on the slip fitting are intact. Replace the O-rings if they are worn or damaged.



EH1721 SERIES ELECTRIC FRYERS CHAPTER 4: BUILT-IN FILTRATION

4.3.1 Pan Preparation (cont.)

9. Install the crumb tray in the pan, ensuring proper placement over the slip fitting tube.



Replace the crumb tray in the pan.

10. Replace the front and back pan covers on the pan. Ensure that the pan covers properly overlap the filter pan (arrows), indicating correct placement.

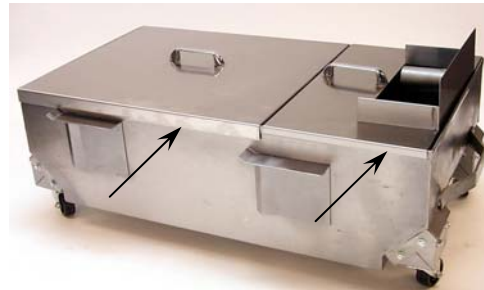

Replace front and rear pan covers on pan.

11. Install the prepared filter pan into the fryer cabinet. Ensure that the slip fittings engage properly prior to activating filter pump.



Install the prepared filter pan into fryer cabinet.

EH1721 SERIES ELECTRIC FRYERS CHAPTER 4: BUILT-IN FILTRATION

4.3.2 Filter Operation

⚠ CAUTION

NEVER operate the filter unit unless oil is at operating temperature [~350°F (177°C)].

1. Ensure the filter pan assembly is prepared as described in Section 4.3.1- Pan Preparation.
2. Ensure the oil is at operating temperature and turn the fryer off.
3. Remove fry baskets from frypot. Prior to filtering, skim any large debris from the oil. Use extreme caution, as oil is at or near operating temperature [350°F (177°C)].

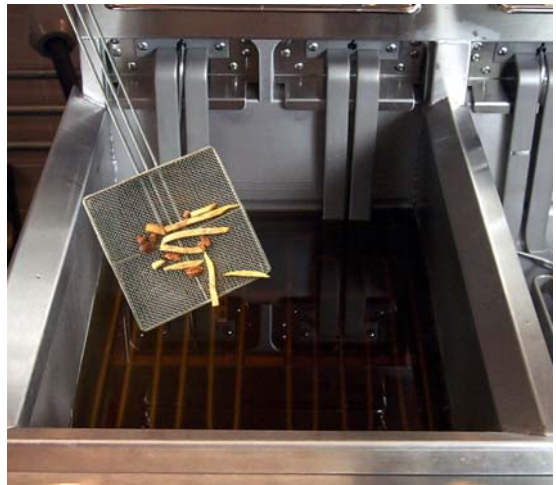

Prior to filtering, skim any large debris from oil in frypot.

4. After ensuring the filter pan is correctly positioned under the drain tubes, pull the red handle to drain the frypot into the filter pan. Drain **ONLY** one frypot at a time. The filter pan is designed to hold the contents of one frypot only.



Pull the red handle to open the drain valve.

EH1721 SERIES ELECTRIC FRYERS CHAPTER 4: BUILT-IN FILTRATION

4.3.2 Filter Operation (cont.)

5. After all oil has drained from the frypot into the filter pan, pull the yellow handle to open the oil return lines and activate the filter pump.



Pull the yellow handle to open the oil return valve and activate the filter pump.

6. Oil will begin to pump from the filter pan into the frypot. Allow the oil to circulate for approximately 5 minutes to remove suspended particles. If the frypot sides and bottom have sediment deposits, lift the heating elements and clean the frypot with the cleaning brush included with the fryer.



Allow the oil to circulate for 5 minutes to ensure all sediment and suspended particles are removed.

7. After the oil is filtered, close the drain valve (push the red handle until it stops) and allow the fryer to refill.



Frypot refilling with filtered oil.

EH1721 SERIES ELECTRIC FRYERS CHAPTER 4: BUILT-IN FILTRATION

4.3.2 Filter Operation (cont.)

8. After all the oil is pumped back into the frypot, bubbles will form, indicating air in the oil return lines. Allow the oil to bubble for 10-15 seconds to ensure oil is evacuated from the return lines. Push the yellow handle to close the oil return valve and deactivate the filter pump.



Allow the oil to bubble for 10-15 seconds to ensure evacuation of all oil in the return lines.

9. If the oil level is low, add oil until the level is at the top OIL LEVEL line. Remember, the oil is at operating temperature. Turn the fryer on.



Add oil until the oil level is at the top OIL LEVEL line. DO NOT OVERFILL THE FRYPOT.

10. Do not allow crumbs to accumulate in the crumb tray. The crumb tray MUST be emptied into a fireproof container at the end of frying operations EACH day.



Never allow crumbs to accumulate in the crumb tray. Empty the tray at the end of each working day.

EH1721 SERIES ELECTRIC FRYERS CHAPTER 4: BUILT-IN FILTRATION

4.3.2 Filter Operation (cont.)

11. Three-battery and larger systems may come equipped with an optional drain flush. After filtering frypot #3 (farthest from the filter) for 5 minutes, close the oil return valve to stop the filtering process. Do not refill the frypot. Close the drain valve (red handle) on the frypot being filtered. Ensure all other valves (red and yellow handles) are closed. Pull the blue handle to open the flush valve. After the drain line is clear of sediment (approximately 2 minutes), push the blue handle to close flush valve. Open the oil-return valve (yellow handle) to refill the frypot.



Drain-flush handle (blue) location.

DANGER

The crumb tray in fryers equipped with a filter system must be emptied into a fireproof container at the end of frying operations each day. Some food particles can spontaneously combust if left soaking in certain shortening material.

WARNING

Do not bang fry baskets or other utensils on the fryer's joiner strip. The strip is present to seal the joint between the frypots. Banging fry baskets on the strip to dislodge shortening will distort the strip, adversely affecting its fit. It is designed for a tight fit and should only be removed for cleaning.

EH1721 SERIES ELECTRIC FRYERS

CHAPTER 5: OPERATOR TROUBLESHOOTING

5.1 Introduction

This section provides an easy reference guide to some of the common problems that may occur during the operation of this equipment. The troubleshooting guides that follow are intended to help correct, or at least accurately diagnose, problems with this equipment. Although the chapter covers the most common problems reported, you may encounter problems that are not covered. In such instances, the Frymaster Technical Services staff will make every effort to help you identify and resolve the problem.

When troubleshooting a problem, always use a process of elimination starting with the simplest solution and working through to the most complex. Never overlook the obvious – anyone can forget to plug in a cord or fail to close a valve completely. Most importantly, always try to establish a clear idea of why a problem has occurred. Part of any corrective action involves taking steps to ensure that it doesn't happen again. If a controller malfunctions because of a poor connection, check all other connections, too. If a fuse continues to blow, find out why. Always keep in mind that failure of a small component may often be indicative of potential failure or incorrect functioning of a more important component or system.

Before calling a service agent or the Frymaster Dean HOTLINE (1-800-551-8633):

- **Verify that electrical cords are plugged in and that circuit breakers are on.**
- **Verify that frypot drain valves are fully closed.**

 **DANGER**

Hot oil will cause severe burns. Never attempt to move this appliance when filled with hot oil or to transfer hot oil from one container to another.

 **DANGER**

This equipment should be unplugged when servicing, except when electrical circuit tests are required. Use extreme care when performing such tests.

This appliance may have more than one electrical power supply connection point. Disconnect all power cords before servicing.

Inspection, testing, and repair of electrical components should be performed by an authorized service agent only.

**EH1721 SERIES ELECTRIC FRYERS
CHAPTER 5: OPERATOR TROUBLESHOOTING**

5.2 Troubleshooting

5.2.1 Control and Heating Problems

Problem	Probable Causes	Corrective Action
Controller won't activate.	A. Power cord is not plugged in or circuit breaker is tripped.	A. Plug power cord in and verify that circuit breaker is not tripped.
	B. Controller has failed.	B. Call FASC.
	C. Power supply component or interface board has failed.	C. If any of the components in the power supply system (including the transformer and interface board) fail, power will not be supplied to the controller and it will not function. Determining which component has failed is beyond the scope of operator troubleshooting. Call FASC.
Fryer does not heat.	A. Drain valve is open.	A. This fryer is equipped with a drain safety switch that prevents the heating element from being energized if the drain valve is not fully closed. Verify that the drain valve is fully closed.
	B. Controller has failed.	B. Call FASC.
	C. One or more other components have failed.	C. If the circuitry in the fryer control system cannot determine the frypot temperature, the system will not allow the element to be energized or will de-energize the element if it is already energized. If the contactor, element, or associated wiring fails, the element will not energize. Determining which specific component is malfunctioning is beyond the scope of operator troubleshooting. Call FASC.

**EH1721 SERIES ELECTRIC FRYERS
CHAPTER 5: OPERATOR TROUBLESHOOTING**

5.2.1 Control and Heating Problems (cont.)

Problem	Probable Causes	Corrective Action
<p style="text-align: center;">Fryer repeatedly cycles on and off when first started.</p>	<p>Fryer is in melt-cycle mode.</p>	<p>This is normal for fryers equipped with <i>CM III.5 computers and Digital Controllers</i>. The default operational mode for these controllers is for the elements to cycle on and off until the temperature in the frypot reaches 180°F (82°C). In CM III.5 computers, CYCL will appear in the display when in the melt-cycle mode. Refer to the separate <i>Frymaster Fryer Controllers User's Manual</i> for the procedure for canceling the melt-cycle for the particular controller installed on your fryer.</p> <p>In fryers equipped with <i>Solid State (Analog)</i> controllers, the melt-cycle is controlled manually by means of the rocker switch to the right of the temperature control knob. <i>If not using solid shortening</i>, press the rocker switch to the OFF position to turn off the melt-cycle.</p>
<p style="text-align: center;">Fryer does not heat after filtering.</p>	<p>Drain valve is open.</p>	<p>This fryer is equipped with a drain safety switch that prevents the heating element from being energized if the drain valve is not fully closed. Verify that the drain valve is fully closed.</p>
<p style="text-align: center;">Fryer heats until high-limit trips with heat indicator ON.</p>	<p>Temperature probe or controller has failed.</p>	<p>Determining which specific component is beyond the scope of operator troubleshooting. Call FASC.</p>
<p style="text-align: center;">Fryer heats until high-limit trips without heat indicator ON.</p>	<p>Contact or controller has failed.</p>	<p>Determining which specific component is malfunctioning is beyond the scope of operator troubleshooting. Call FASC.</p>
<p style="text-align: center;">Fryer stops heating with heat indicator ON.</p>	<p>The high-limit thermostat or contactor has failed.</p>	<p>The fact that the heat indicator is ON indicates that the controller is functioning properly and is calling for heat. The high-limit thermostat functions as a normally closed switch. If the thermostat fails, the "switch" opens and power to the elements is shut off. If the contactor fails to close, no power is supplied to the elements. Determining which component has failed is beyond the scope of operator troubleshooting. Call FASC.</p>

**EH1721 SERIES ELECTRIC FRYERS
CHAPTER 5: OPERATOR TROUBLESHOOTING**

5.2.2 Error Messages and Display Problems

Problem	Probable Causes	Corrective Action
Display is in wrong temperature scale (Fahrenheit or Celsius).	Incorrect display option programmed.	Computers may be programmed to display in either Fahrenheit or Celsius. Refer to the computer manual that shipped with the fryer for instructions on changing the display.
CM III.5 or Digital Controller display shows HELP. CM4-S and KFC-1 display shows OPEN DRAIN	Open drain valve or problem with latching circuitry.	Verify that the drain valve is fully closed. The fryer will not function if the drain valve is not fully closed. If the drain valve is fully closed, the problem is within the latching circuitry and is beyond the scope of operator troubleshooting. Call FASC.
Display shows HI.	Fryer is more than 21°F (12°C) above setpoint.	This display is normal if the fryer setpoint has been changed to a lower temperature. The display should revert to the normal four dashes when the frypot temperature cools to the setpoint. If the setpoint has not been changed, this indicates a problem with the temperature control circuitry. Turn the fryer off and call FASC.
CM III.5 or Digital Controller display shows HOT. CM4-S and KFC-1 display shows HI-TEMP or HI-TEMP PROBE FAILURE.	Frypot temperature is more than 410°F (210°C) or, in CE countries, 395°F (202°C).	This is an indication of a malfunction in the temperature control circuitry, including a failure of the high-limit thermostat. Shut the fryer down immediately and call FASC.
CM III.5 or Digital Controller display shows LO.	Frypot temperature is more than 21°F (12°C) below setpoint.	This display is normal when the fryer is first turned on and may appear for a short while if a large batch of frozen product is added to the frypot. If the display never goes out, the fryer is not heating. Look for a decimal in the LED display between digits 1 and 2. If the decimal is present, the computer is calling for heat and is functioning properly. See <i>Fryer Does Not Heat</i> in Control and Heating Problems (Section 5.2.1). If the decimal is not present, the computer is not calling for heat and may be malfunctioning. Shut the fryer off and call FASC.

**EH1721 SERIES ELECTRIC FRYERS
CHAPTER 5: OPERATOR TROUBLESHOOTING**

5.2.2 Error Messages and Display Problems (cont.)

Problem	Probable Causes	Corrective Action
CM4-S and KFC-1 display shows LOW.	Fryer temperature is below 255°F (124°C).	This display is normal when the fryer is first turned on. If the display never goes out, the fryer is not heating and may be malfunctioning. Shut the fryer off and call FASC.
CM4-S and KFC-1 display shows IGNITION FAILURE.	Fryer's ignition module has failed. Fryer will not ignite or heat.	Shut the fryer off and call FASC.
CM III.5 or Digital Controller display shows Prob. CM4-S and KFC-1 display shows PROBE FAILURE.	Problem with the temperature measuring circuitry including the probe.	This indicates a problem within the temperature measuring circuitry that is beyond the scope of operator troubleshooting. Shut the fryer off and call FASC.
CM III.5 frypot temperature is displayed constantly.	Computer is programmed for constant temperature display.	The CM III.5 computer may be programmed for constant temperature display or countdown timer display. Refer to the separate <i>Frymaster Fryer Controllers User's Manual</i> for instructions on toggling between these display options.

5.2.3 Basket Lift Problems

Problem	Probable Causes	Corrective Action
Basket lift movement is noisy, jerky, or erratic.	Lack of lubrication on basket lift rods.	Apply a light coating of Lubriplate or similar lightweight white grease to the rod and bushings.

5.2.4 Built-in Filtration Problems

Problem	Probable Causes	Corrective Action
Filter pump won't start.	A. Power cord is not plugged in or circuit breaker is tripped.	A. Verify that the power cord is fully plugged in. If so, verify that circuit breaker is not tripped.
	B. Pump motor has overheated causing the thermal overload switch to trip.	B. If the motor is too hot to touch for more than a few seconds, the thermal overload switch has probably tripped. Allow the motor to cool at least 45 minutes then press the Pump Reset Switch.

**EH1721 SERIES ELECTRIC FRYERS
CHAPTER 5: OPERATOR TROUBLESHOOTING**

5.2.4 Built-in Filtration Problems (cont)

Problem	Probable Causes	Corrective Action
Filter pump won't start. (cont)	C. Blockage in filter pump. Test: Close the drain valve and pull the filter pan out from the fryer. Activate the pump. If the pump motor hums for a short time then stops, the probable cause is blockage of the pump itself.	C. Pump blockages are usually caused by sediment buildup in the pump due to improperly sized or installed filter paper and failure to use the crumb screen. Call FASC.

**EH1721 SERIES ELECTRIC FRYERS
CHAPTER 5: OPERATOR TROUBLESHOOTING**

5.3 Recommended Spare Parts

Below is a list of recommended spare parts that might need replacing during the life of EH1721 Series Electric Fryers.

ELEMENTS: Determine what elements are required and order from the list below.	
Part Number	Description
807-3652	Element- 208V 8.5 kW
807-3675	Element- 480V 10.25 kW
807-3655	Element- 240V 8.5 kW
807-3657	Element- 208V 9.0 kW
807-3658	Element- 240V 9.0 kW
807-2557	Element- 208V 10.25 kW
807-3655	Element- 240V 8.5 kW (USE FOR 220V 7 kW)
807-3660	Element- 220V 8.5 kW
807-3661	Element- 220V 10.25 kW
807-3662	Element- 230V 7 kW
807-3663	Element- 230V 8.5 kW
807-3664	Element- 230V 10.25 kW
807-2637	Element- 240V 10.25 kW
807-3660	Element- 220V 8.5 kW (USE FOR 200V 7 kW)
826-1791	Probe, Temperature- 15" (Includes Ty Wrap)
806-8035	High Limit- 435°F (224°C)- All Units Non-CE
806-8132	High-Limit- 415°F (213°C)- All but 21kW Units CE
806-8536	High-Limit- 405°F (207°C)- 21kW Units Only CE
807-0979	Transformer, 208-240V, 50/60Hz –12V 20VA
807-0680	Transformer, 208-240V, 50/60Hz –24V 20VA
807-1071	Contactora, Mercury- 240VAC 30-Amp (17 kW Units)
807-0884	Contactora, Mercury- 240VAC 50-Amp (21 kW Units)
810-1202	Contactora, Latching- 40-Amp, 3-Pole
807-3611	Relay, MEC GL-DPDT-24A



Enodis[®]
One Company, Countless Solutions

Frymaster, L.L.C., 8700 Line Avenue, PO Box 51000, Shreveport, Louisiana 71135-1000
Shipping Address: 8700 Line Avenue, Shreveport, Louisiana 71106

TEL 1-318-865-1711

FAX (Parts) 1-318-219-7140

FAX (Tech Support) 1-318-219-7135

PRINTED IN THE UNITED STATES

SERVICE HOTLINE
1-800-551-8633

Price: \$12.00
819-5713
APRIL 2005