

Planar PS5580 Installation Guide



Copyright © 10 March 2014 by Planar Systems, Inc. All rights reserved.
Contents of this publication may not be reproduced in any form without permission of Planar Systems, Inc.

Trademark Credits

Windows™ is a trademark of Microsoft Corp.
All other names are trademarks or registered trademarks of their respective companies.

Disclaimer

The information contained in this document is subject to change without notice. Planar Systems, Inc. makes no warranty of any kind with regard to this material. While every precaution has been taken in the preparation of this manual, the Company shall not be liable

for errors or omissions contained herein or for incidental or consequential damages in connection with the furnishing, performance, or use of this material.

Warranty and Service Plans

Planar warranty and service plans will help you maximize your investment by providing great support, display uptime, and performance optimization. From post-sale technical support to a full suite of depot services, our services are performed by trained Planar employees. When you purchase a Planar product, you get more than a display, you get the service and support you need to maximize your investment. To find the latest warranty and service information regarding your Planar product, please visit:

<http://www.planarcontrolroom.com/support>

Warranty Features

- 3-year protection from defects in material and workmanship
- Advanced shipment of replacement part or product
- Access to 24/7 emergency phone support
- Please visit: http://www.planar.com/support/warranty/standard_warranties/ for a full warranty review.

RoHS Compliance Statement

All Planar PS5580 displays are fully RoHS compliant.

ADA Compliance Statement

All Planar PS5580 displays are compliant with the Americans with Disabilities Act.

Note: The RS232 command set and Ethernet command set are described in a separate document: **PS5580 RS232 and LAN Command Protocol.pdf**

Document number: 020-1255-00C

Contents

Warranty Features	ii
Introduction	1
Safety Information	2
Environmental Conditions for Installation	4
Recommended Operating Conditions	4
European Disposal Information	5
Burn-In Versus Temporary Image Retention	6
Normal Use Thermal Guidelines	6
Handling the Display	7
Unpacking and Checking Display Accessories	8
Installing PS5580 Displays on VESA Mounts	10
Intermediate Rows	10
Last (Top) Row	11
Removing a panel	11
Connecting Cables	12
Parts of the Display	12
Input Ports	12
Remote Control	13
Connecting Multiple PS5580s Using DisplayPort In	14
Connecting Multiple PS5580s Using HDMI In	15
Connecting Multiple PS5580s Using DVI In	16
Connecting Multiple PS5580s Using PC In	17
Connecting For Remote Control	18
Connecting RS232 Cable and IR Receiver	18
Connecting Ethernet Cable	19

Operation	20
How to use the Remote Control	20
Configuration	21
Picture Mode	21
Screen A Mode (for PC In)	22
Setup A Menu	23
Setup B Menu	24
Options	25
Color Balancing the Wall	26
Color Temperature	26
Supported Input Signal Resolution	27
Specifications	29
Dimensions	30
Regulatory Information	31
Customer Support Information	32
Customer Support Contact Information and Hours of Operation	32
Warranty and Service Plans	32
Warranty Features	32

Introduction

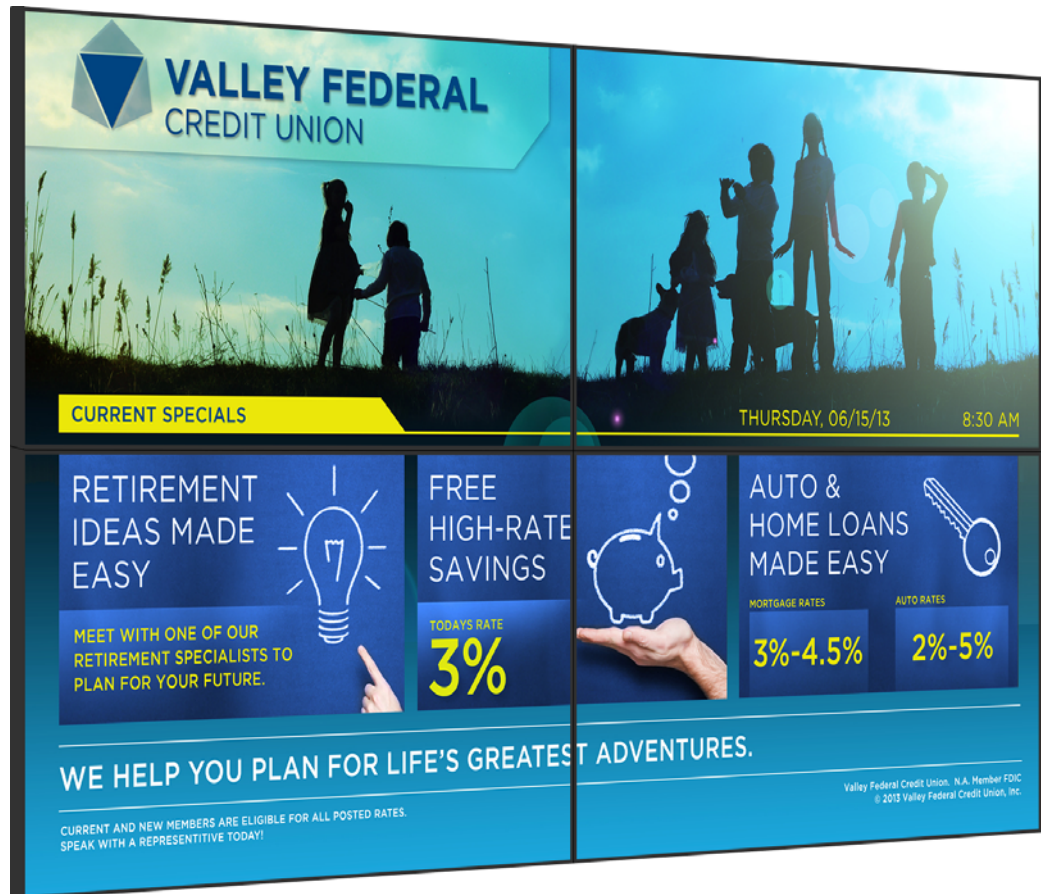

This manual describes how to use the PS5580 and gives notes on its use.

Please read the manual carefully before using this display.

If you have any questions or problems, please contact Planar technical support:

- <http://www.planarcontrolroom.com/support>
- +1-503-748-5799

Safety Information

This display was designed with safety in mind. If you don't heed the safety warnings and cautions, you could get hurt. The safety warnings are on stickers in various places in and on the display.

- 1** Read these instructions.
- 2** Keep these instructions.
- 3** Heed all warnings.
- 4** Follow all instructions.
- 5** Do not use any of the Planar PS5580 products near water.
- 6** Do not install near any heat sources such as radiators, heat registers, stoves or other apparatus (including amplifiers) that produce heat.
- 7** Do not defeat the safety purpose of the polarized or grounding type plug. A polarized plug has two blades with one wider than the other. A grounding type plug has two blades and a third grounding prong. The wide blade or the third prong is provided for your safety. When the provided plug does not fit into your outlet, consult an electrician for the replacement of the obsolete outlet.
- 8** Protect the power cord from being walked on or pinched particularly at plugs, convenience receptacles and the point where they exit from any of the Planar PS5580 products.
- 9** Only use the attachments/accessories specified by the manufacturer.
- 10** Unplug all Planar PS5580 products during lightning storms or when unused for long periods of time.
- 11** You must follow all National Electrical Code regulations. In addition, be aware of local codes and ordinances when installing your system.
- 12** Refer all servicing to qualified service personnel. Servicing is required when any of the Planar PS5580 displays have been damaged in any way, such as the AC power cord or plug is damaged, liquid has been spilled or objects have fallen into the display, or if the displays have been exposed to rain or moisture, do not operate normally or have been dropped.
- 13** Keep the packing material in case the equipment should ever need to be shipped.

- 14** Wall mounts must be secure. The wall must be strong enough to hold all displays, mounts, brackets and cables.
- 15** Slight pressure on the LCD will cause distortion of the image. Heavier pressure will cause permanent damage. Planar PS5580 configurations should be mounted in a way that viewers cannot insert small objects in the openings that will create hazards by contacting bare conductive parts.

Environmental Conditions for Installation

- Since the PS5580 panel is very sensitive to physical impact, installation requires considerable caution
- Minimum clearance (20 mm) must be observed—top, bottom, and both sides—for proper ventilation. Installation must avoid air-tight or nearly air-tight places. Improper ventilation causes malfunction and shortens product life by a rapid internal temperature rise. If the PS5580 must be installed with improper ventilation, additional ventilation openings or fans must be provided to keep the internal temperature between 0°-35°C (32°-95°F).
- For grounding the PS5580 and attached devices, it should be connected as a frame ground.
- Considering the PS5580 max power consumption, check the main electrical specification.
- Regularly clean the vent holes in the back of the PS5580 to prevent overheating.

Recommended Operating Conditions

- Temperature: 5-35°C (41-95°F)
- Humidity 35-75%
- Do not install the set in an air-tight condition; provide adequate ventilation.
- Do not install the set in a place of direct sunlight or excessive exposure to lights.

WARNING Blackening, stains or burning effect on the screen may occur through improper installation or use outside these recommended conditions.

European Disposal Information

English

- Disposal of old Electrical & Electronic Equipment (Applicable throughout the European Union and other European countries with separate collection programs)

This symbol found on your product or on its packaging, indicates that this product should not be treated as household waste when you wish to dispose of it. Instead, it should be handed over to an applicable collection point for the recycling of electrical and electronic equipment. By ensuring this product is disposed of correctly, you will help prevent potential negative consequences to the environment and human health, which could otherwise be caused by inappropriate disposal of this product. The recycling of materials will help to conserve natural resources.



This symbol is only valid in the European Union. If you wish to discard this product, please contact your local authorities or dealer and ask for the correct method of disposal.

Español

- Deshecho de equipos eléctricos y electrónicos (aplicable a la Unión Europea y a otros países europeos con programas de reciclaje independientes)

La presencia de este símbolo en el propio producto o en su material de embalaje, indica que no se debe tratar como residuo doméstico cuando desee deshacerse de él. En su lugar, debe entregarlo en el punto limpio correspondiente de reciclaje de equipos eléctricos y electrónicos. Asegurándose de que este producto se desecha de forma correcta, ayudará a evitar posibles consecuencias negativas para la conservación del medioambiente y la salud humana, consecuencias que podrían darse si se deshaece del producto de forma inadecuada. El reciclado de materiales ayuda a conservar los recursos naturales.

Svenska

- Avfall av förbrukad elektrisk och elektronisk utrustning (Tillämpbart i hela Europeiska unionen och andra europeiska länder med separata samlingsprogram)

Den här symbolen som finns på din produkt eller på dess förpackning påvisar att produkten inte ska behandlas som hushållsavfall när du vill slänga bort den. Istället ska den lämnas över till en lämplig uppsamlingspunkt för återvinning av elektriska och elektroniska utrustningar. Genom att tillförsäkra att den här produkten återvinns på ett riktigt sätt hjälper du till med att förhindra möjliga negativa konsekvenser för miljön och mänsklig hälsa. Det kan annars orsakas på grund av olämplig sophantering av den här produkten. Återvinning av material kommer att hjälpa till att bevara naturtillgångar.



Den här symbolen är endast giltig inom den Europeiska unionen. Om du vill slänga bort den här produkten ska du kontakta lokala myndigheter eller återförsäljare, och fråga efter lämplig avfallsmetod.

Svenska

- Avfall av förbrukad elektrisk och elektronisk utrustning (Tillämpbart i hela Europeiska unionen och andra europeiska länder med separata samlingsprogram)

Den här symbolen som finns på din produkt eller på dess förpackning påvisar att produkten inte ska behandlas som hushållsavfall när du vill slänga bort den. Istället ska den lämnas över till en lämplig uppsamlingspunkt för återvinning av elektriska och elektroniska utrustningar. Genom att tillförsäkra att den här produkten återvinns på ett riktigt sätt hjälper du till med att förhindra möjliga negativa konsekvenser för miljön och mänsklig hälsa. Det kan annars orsakas på grund av olämplig sophantering av den här produkten. Återvinning av material kommer att hjälpa till att bevara naturtillgångar.



Den här symbolen är endast giltig inom den Europeiska unionen. Om du vill slänga bort den här produkten ska du kontakta lokala myndigheter eller återförsäljare, och fråga efter lämplig avfallsmetod.

Français

- Mise au rebut des équipements électriques et électroniques usagés (Valable dans l'ensemble de l'Union Européenne ainsi que dans les pays européens disposant de programmes distincts de collecte des déchets)

Ce symbole appliqué sur votre produit ou sur son emballage indique que ce produit ne doit pas être traité comme un déchet ménager lorsque vous voulez le mettre au rebut. Il doit au contraire être remis à un site de collecte agréé pour le recyclage des équipements électriques et électroniques. En veillant à ce que ce produit soit mis au rebut de façon adéquate, vous contribuerez à prévenir les conséquences potentiellement négatives sur l'environnement et sur la santé humaine qui risqueraient de se produire en cas de mise au rebut inappropriée de ce produit. Le recyclage des matériaux contribuera également à économiser les ressources naturelles.



Ce symbole n'est valable que dans l'Union Européenne. Si vous souhaitez mettre ce produit au rebut, veuillez prendre contact avec les autorités locales ou avec votre revendeur et renseignez-vous sur la méthode de mise au rebut correcte.

Italiano

- Smaltimento delle attrezzature elettriche ed elettroniche usate (applicabile in tutta la Comunità Europea ed altri Paesi Europei che applicano programmi di raccolta differenziata)

Il simbolo trovato sul prodotto, o sulla sua confezione, indica che il prodotto non può essere trattato come i domestici quando è il momento di smaltirlo. Al contrario, deve essere consegnato ad un centro di raccolta specializzato nel riciclaggio di attrezzature elettriche ed elettroniche. Assicurando che il corretto smaltimento di questo prodotto, si aiuterà a prevenire potenziali conseguenze negative sull'ambiente e sulla salute umana, che possono essere provocate da uno scorretto smaltimento di questa attrezzatura. I materiali riciclati aiuteranno a conservare le risorse naturali.

Suomi

- Vanhon sähkö- ja elektroniikkalaitteiden hävittäminen (Soveltuva kaikkialla Euroopan unionin alueella, sekä muissa Euroopan maissa, joilla on erilliset keräysohjelmat)

Jos tuotteessa tai sen pakkauksessa on tämä symboli, sitä ei pidä hävitettävässä käsitellä tavallisena kotitalousjätteenä, vaan se kuuluu toimittava sähkö- ja elektroniikkalaitteiden kierrätyspiireeseen. Varmistamalla, että tämä tuote hävitetään asianmukaisella tavalla autat estämään mahdollisia ympäristölle ja ihmisille koituvia negatiivisia seurauksia, joita sen väärinlainen hävittäminen voi aiheuttaa. Materiaalien kierrättäminen auttaa säilyttämään luonnonvarjoja.



Tämä symboli on voimassa ainoastaan Euroopan unionin alueella. Jos haluat hävittää tämän tuotteen, ota yhteyttä paikallisiin viranomaisiin tai jälleenmyyjään ja tiedustele asianmukaisia hävittämisohjelmia.

Suomi

- Vanhon sähkö- ja elektroniikkalaitteiden hävittäminen (Soveltuva kaikkialla Euroopan unionin alueella, sekä muissa Euroopan maissa, joilla on erilliset keräysohjelmat)

Jos tuotteessa tai sen pakkauksessa on tämä symboli, sitä ei pidä hävitettävässä käsitellä tavallisena kotitalousjätteenä, vaan se kuuluu toimittava sähkö- ja elektroniikkalaitteiden kierrätyspiireeseen. Varmistamalla, että tämä tuote hävitetään asianmukaisella tavalla autat estämään mahdollisia ympäristölle ja ihmisille koituvia negatiivisia seurauksia, joita sen väärinlainen hävittäminen voi aiheuttaa. Materiaalien kierrättäminen auttaa säilyttämään luonnonvarjoja.



Tämä symboli on voimassa ainoastaan Euroopan unionin alueella. Jos haluat hävittää tämän tuotteen, ota yhteyttä paikallisiin viranomaisiin tai jälleenmyyjään ja tiedustele asianmukaisia hävittämisohjelmia.

Deutsch

- Entsorgung von elektrischen & elektronischen Altgeräten (geltend für die europäische Gemeinschaft und andere europäische Länder mit separaten Sammelprogrammen)

Dieses Symbol, zu finden auf Ihrem Produkt oder dessen Verpackung, macht Sie darauf aufmerksam, dass dieses Produkt bei der Entsorgung nicht als Hausmüll behandelt werden darf. Statt dessen sollte es an eine Sammelstelle zum Recycling von elektrischen und elektronischen Altgeräten gegeben werden. Helfen Sie mit, potenziell schädliche Einflüsse auf Umwelt und Gesundheit, die durch eine unsachgemäße Entsorgung dieses Produktes entstehen können, zu vermeiden und entsorgen Sie dieses Produkt ordnungsgemäß. Recycling hilft, natürliche Rohstoffe einzusparen.



Dieses Symbol ist nur innerhalb der europäischen Gemeinschaft gültig. Wenn Sie dieses Produkt entsorgen möchten, wenden Sie sich bitte an Ihre örtliche Behörde und fragen Sie nach der ordnungsgemäßen Entsorgungsmethode.

Nederlands

- Verwijderen van oude elektrische en elektronische apparatuur (toepasselijk in de volledige Europese Unie en andere Europese landen met afzonderlijke programma's voor afvalverzameling)

Dit symbool dat op het product of zijn verpakking is aangebracht, geeft aan dat dit product niet mag worden behandeld als huishoudelijk afval als u het wilt wegwerpen. U moet het afgeven bij een specifiek verzamelpunt voor de recycling van elektrische en elektronische apparatuur. Door te garanderen dat u dit product op de correcte manier wegwerpt, helpt u potentiële negatieve gevolgen voor het milieu en de menselijke gezondheid, die zouden kunnen worden veroorzaakt door een onrechtmatig wegwerpen van het product, te voorkomen. De recycling van materialen helpt het behoud van natuurlijke bronnen.

Waste Electrical and Electronic Equipment (WEEE) Yönergeleri Avrupa Birliği'nde bu etiket, ürünün ev elektroniği aletleri atıkları ile imha edilemeyeceğini gösterir. Kurtarmak ve geri dönüşümünü sağlamak için uygun şartlarda saklanması gerekir. EEE Yönetmeliğine Uygunur Ve Elektronik Eşyalarda Bazı Zararlı Maddelerin Kullanımının Sinirlendirilmesinde Dair Yönetmelik.

Waste Electrical and Electronic Equipment (WEEE) Yönergeleri Avrupa Birliği'nde bu etiket, ürünün ev elektroniği aletleri atıkları ile imha edilemeyeceğini gösterir. Kurtarmak ve geri dönüşümünü sağlamak için uygun şartlarda saklanması gerekir. EEE Yönetmeliğine Uygunur Ve Elektronik Eşyalarda Bazı Zararlı Maddelerin Kullanımının Sinirlendirilmesinde Dair Yönetmelik.

Waste Electrical and Electronic Equipment (WEEE) Yönergeleri Avrupa Birliği'nde bu etiket, ürünün ev elektroniği aletleri atıkları ile imha edilemeyeceğini gösterir. Kurtarmak ve geri dönüşümünü sağlamak için uygun şartlarda saklanması gerekir. EEE Yönetmeliğine Uygunur Ve Elektronik Eşyalarda Bazı Zararlı Maddelerin Kullanımının Sinirlendirilmesinde Dair Yönetmelik.

Waste Electrical and Electronic Equipment (WEEE) Yönergeleri Avrupa Birliği'nde bu etiket, ürünün ev elektroniği aletleri atıkları ile imha edilemeyeceğini gösterir. Kurtarmak ve geri dönüşümünü sağlamak için uygun şartlarda saklanması gerekir. EEE Yönetmeliğine Uygunur Ve Elektronik Eşyalarda Bazı Zararlı Maddelerin Kullanımının Sinirlendirilmesinde Dair Yönetmelik.

Burn-In Versus Temporary Image Retention

Burn-in causes the screen to retain an image essentially forever, with little or no way to correct the problem. Under normal use, an LCD module will not experience burn-in, as plasma displays do, nor will it retain images in any way.

Normal use of an LCD module is defined as displaying continuously changing video patterns or images. However, LCD modules can experience *temporary* image retention when recommended usage guidelines are not followed.

What is Temporary Image Retention?

Temporary image retention (TIR) can occur when a static image is displayed continuously for extended periods of time. An electrical charge differential may build up between the electrodes of the liquid crystal, which causes a negative-color video image (color-inverted and brightness-inverted version of the previous image) to be retained when a new image is displayed. This behavior is true for any LCD device from any LCD manufacturer.

TIR is not covered under warranty. See standard warranty terms and conditions for details. Here are some guidelines to help you avoid TIR:

- Use the LCD module to show a screen saver, moving images or still pictures that change regularly. When using high-contrast images, reposition the images frequently.
- Turn off the PS5580 when it is not in use.

Normal Use Thermal Guidelines

Normal use of the LCD module and power supply module are defined as operating in the open air to prevent heat buildup, and without direct or indirect heat sources such as lighting fixtures, heating ducts, or direct sunlight that can cause the modules to experience high operating temperatures. For all modules, do not block fans or ventilation openings. If the LCD module will be installed in a recessed area with an LCD surround or enclosure, ensure adequate openings are applied for proper air flow and ventilation.

At 2000 meters altitude or below, the maximum ambient operating temperature for the LCD module cannot be above 104° F (40° C) nor below the minimum ambient operating temperature of (32° F) 0° C. If one of these conditions exists, it is up to the installer to ensure that module placement is changed, thermal shielding is provided and/or additional ventilation is provided to keep the display within its nominal operating parameters.

Handling the Display

- The PS5580 can be damaged even with only minor impact. Shock or impact on the sides or corners can result in internal circuit damage.
- The edges and bottom of the panel are fragile. Use shock-absorbing pads or rugs for laying the display down.
- Always use two persons to carry or install the PS5580.
- Carry the PS5580 with it straight up and down, not flat like a tray.

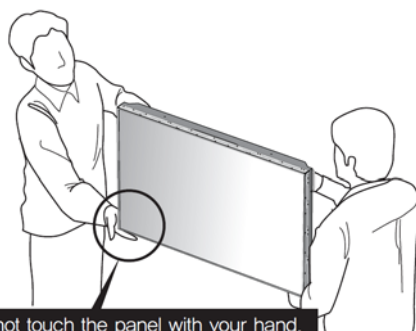

Carry the PS5580 in an upright position. Try not to touch the screen; you will only have to clean it later.

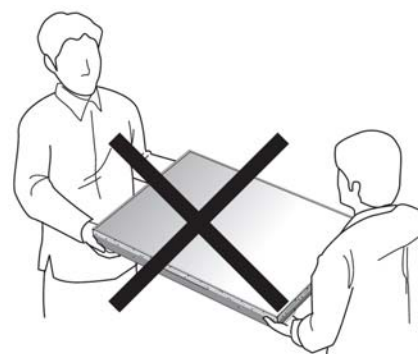

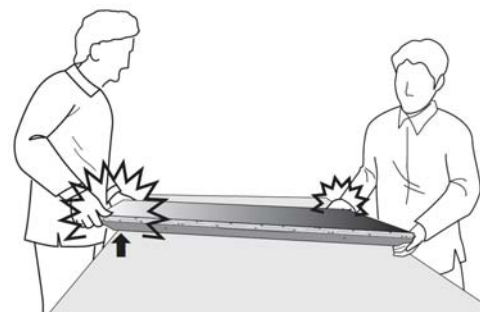

Do not carry the display flat. Its weight can bend and damage it.





When two persons lift the panel, it can become twisted. Coordinate the lifting so this doesn't happen.

Unpacking and Checking Display Accessories

The accessory kit contains these parts.

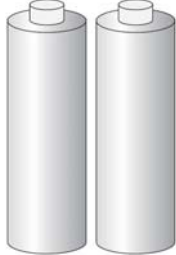
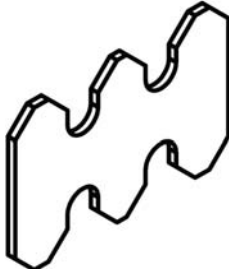
Part	Description	Picture
AC power cord	Power cord (6 ft)	
Remote control	Used to turn on/off displays, as well as to navigate through on-screen menus.	
USB drive or CD	Contains the PS5580 Installation Guide and the PS5580 RS232 and LAN Command Protocol Manual	
IR extender cable	Used to receive signals from the remote	

Part	Description	Picture
DVI Cable	Connects the PS5580 to a computer (5 ft)	
Batteries	Two AAA	
Spacer	<p>Three (3) each</p> <p>These are used for measurement when you mount the displays using a VESA or other mount. They are not used if you mount the displays with Planar's Mounting System.</p>	
Washers	<p>Four (4) 4.3 x 10 x 1T</p> <p>For VESA mounts, under the bolt that holds the spacer in place. They are not used if you mount the displays with Planar's Mounting System.</p>	
Spacer	<p>Four (4) 4.2 x 8 x 2T</p> <p>For VESA mounts, under the washer and "inside" the spacer. They are not used if you mount the displays with Planar's Mounting System.</p>	

Installing PS5580 Displays on VESA Mounts

Note: If you plan to use the Planar Mounting System for these displays, skip this whole section and see the manual Planar PS5580 Planar Mounting System.

- 1 Connect all cables to the panel and hang it in the *lower left corner* of the wall. Be sure the panel is *level*.
- 2 Connect all cables for another display panel, and hang this panel. Hang this to the right of the first panel.
- 3 Where the corners meet along the bottom edge, slip an alignment guide over the corner hardware on the back of the panels. The alignment guide should not protrude beyond the exposed edges of the panels.
- 4 Check that both displays are level and straight.
- 5 Tighten the screws for this alignment guide, compressing the nylon spaces until the guide is held in place.
- 6 Where the corners meet along the top edge, slip an alignment guide over the corner hardware on the back of the panels. The alignment guide should not protrude beyond the exposed edges of the panels.

Note: If there are multiple rows, the alignment guide should protrude beyond the edges of the panels. However, if this is a one-row installation, they should not protrude.

- 7 Tighten all the screws for this alignment guide, compressing the nylon washer.
- 8 Repeat steps 2-7 until the first row is complete.

Intermediate Rows

- 1 Attach all cables and hang the leftmost panel in this second row. The corner hardware should mate with the protruding hardware from the row below.
- 2 Tighten the lower right corner screw so it holds the alignment guide.
- 3 Where the corners meet along the left edge, slip an alignment guide over the corner hardware on the back of the panels. This guide should not protrude. Tighten the screws for this guide.
- 4 Attach cables for the next panel and hang it as the next panel to the right in this row. Be sure the corner hardware mates with the protruding hardware next to it, and that everything is level and straight.

- 5 Where the corners meet along the top edge, slip an alignment guide over the corner hardware on the back. This guide should protrude.
- 6 Tighten the screws for this guide.
- 7 Repeat the steps 1-6 above until all rows *except* the top row are mounted.

Last (Top) Row

Do the steps for "Intermediate Rows" above, *except* the alignment guides along the top should *not* protrude.

Removing a panel

- 1 To remove a panel, all panels above and to the right of the panel you need must be removed, starting with the panel in the upper right corner of the wall.
- 2 For each panel that you remove:
 - a Slightly loosen all the corner screws that are accessible.
 - b Remove any alignment guides that are only connected to one other panel.
 - c Lift the panel to disengage it from the alignment brackets below and remove it from the wall.
- 3 To rebuild the wall, reverse the steps taken for each panel, backtracking until the panel in the upper right corner is in place.

Connecting Cables

Parts of the Display

Input Ports

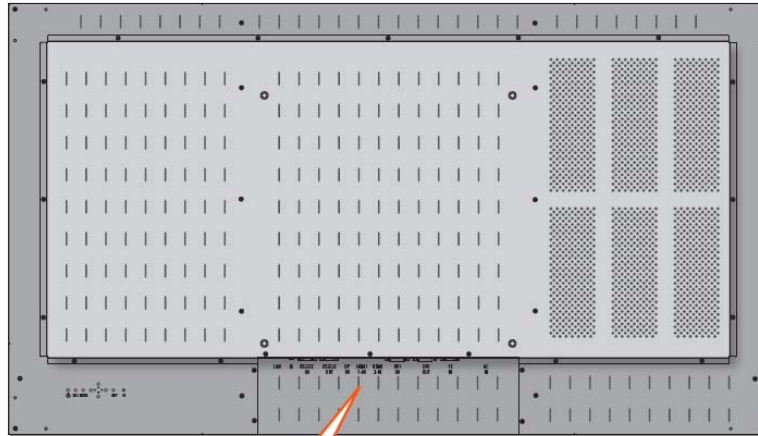

View from the rear

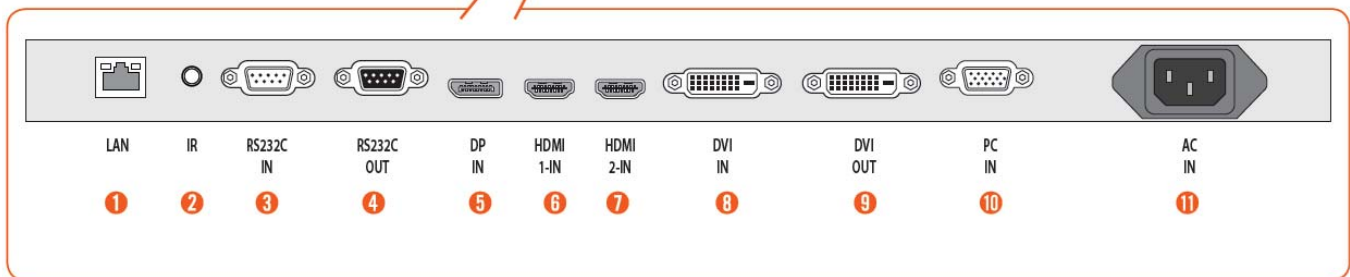

Item #	Connector	Function
1	LAN	Control the display via Ethernet (RJ-45)
2	IR	Remote controller input port
3	RS-232C IN	Control the display via COM port (D-sub 9-pin)
4	RS-232C OUT	Control the display via COM port (D-sub 9-pin)
5	DP IN	Input for DisplayPort signals
6	HDMI 1 IN	Input for HDMI signals
7	HDMI 2 IN	Input for HDMI signals
8	DVI IN	Digital RGB signal, DVI single link 24 pin
9	DVI OUT	Digital RGB signal, DVI single link 24 pin

Item #	Connector	Function
10	PC IN	Analog RGB signal, D-sub, 15-pin
11	AC IN	AC 100V - 240V, 50/60Hz

Remote Control

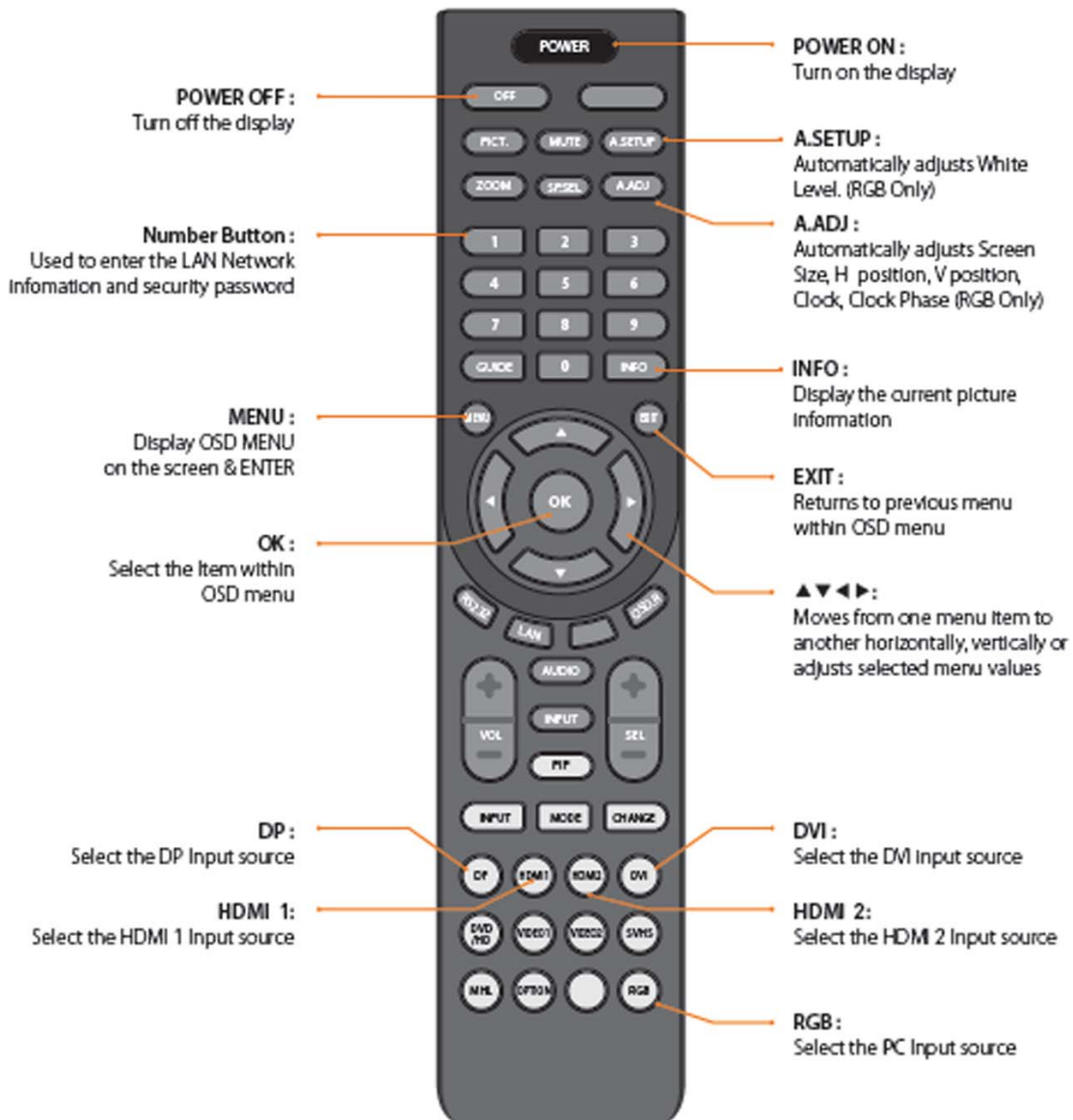

Connecting Multiple PS5580s Using DisplayPort In

Image quality can be affected by cable or signal quality.

Please use a DisplayPort cable with the DisplayPort logo.

The DisplayPort cable has a locking function. Be sure to hold down the top button to release the lock when removing these cables.

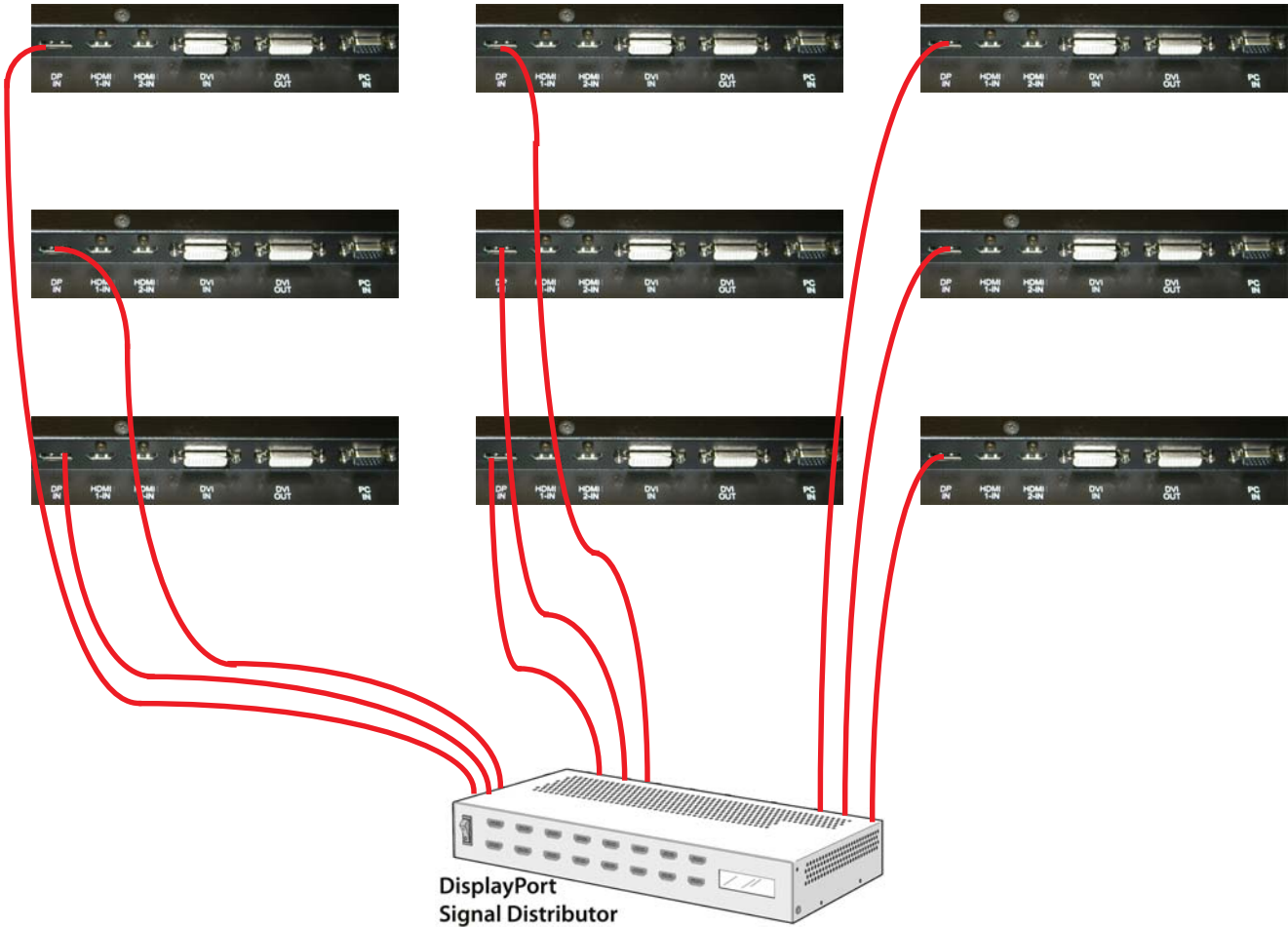

Connecting Multiple PS5580s Using HDMI In

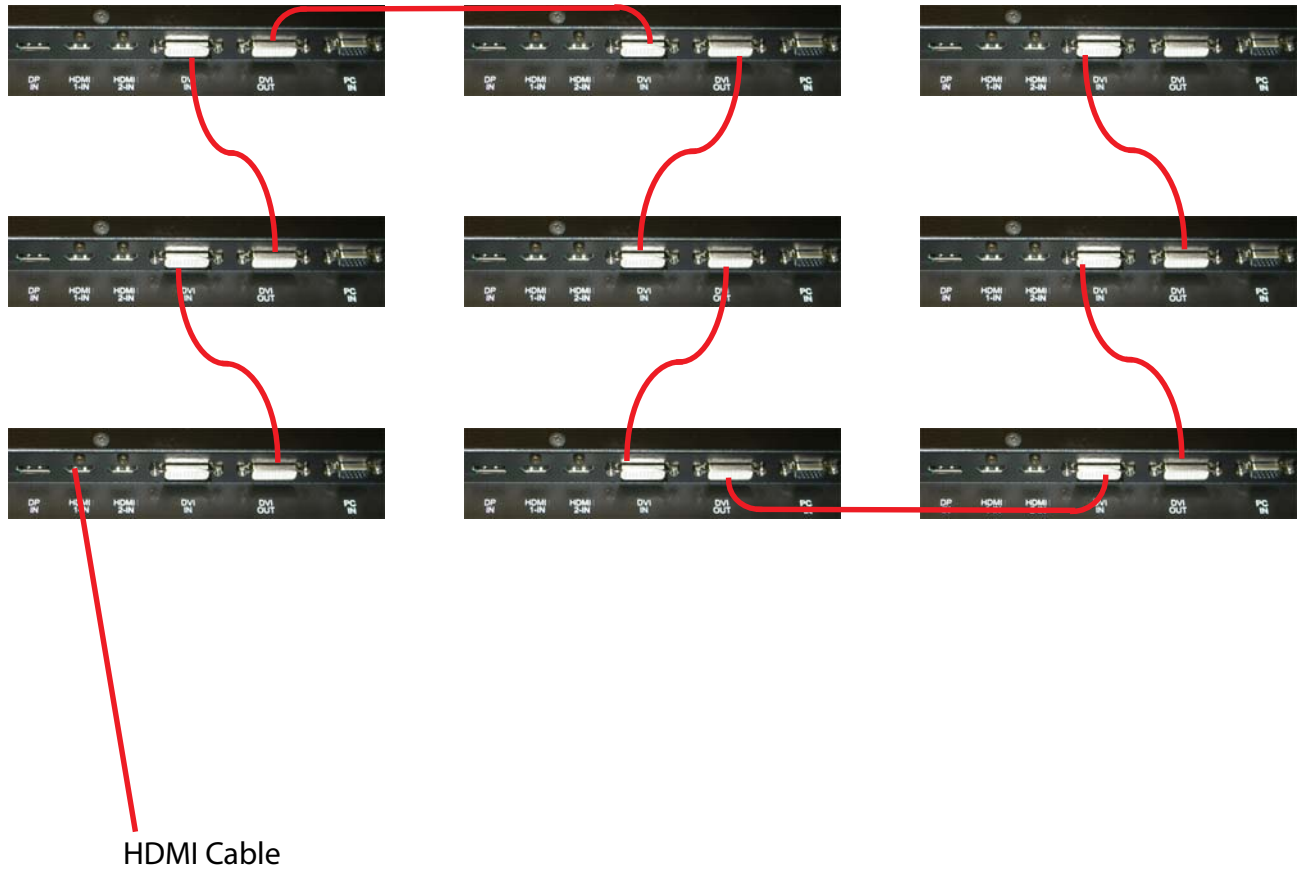

We recommend that you purchase an HDMI-certified cable. Image quality can be affected by cable or signal quality.

Input Source	Resolution	Output Port	Notes
HDMI 1 / HDMI 2	1920 x 1080 x 60Hz	DVI Out	HDCP Available

Connecting Multiple PS5580s Using DVI In

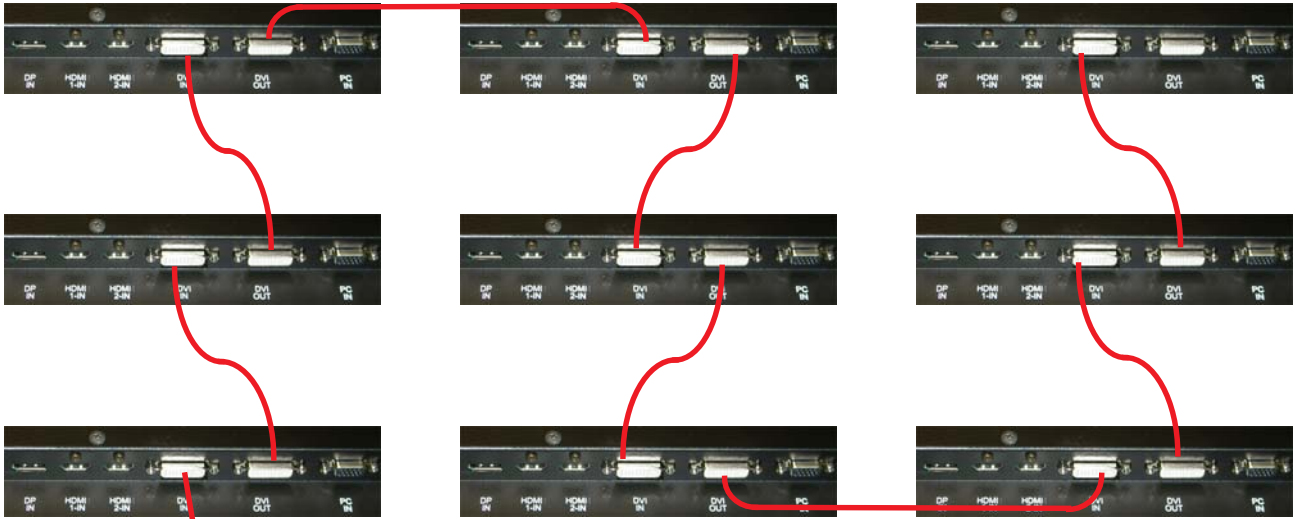

DVI Cable

Image quality can be affected by cable or signal quality.

Input Source	Resolution	Output Port	Notes
DVI	1920 x 1080 x 60Hz	DVI Out	HDCP Available

Connecting Multiple PS5580s Using PC In

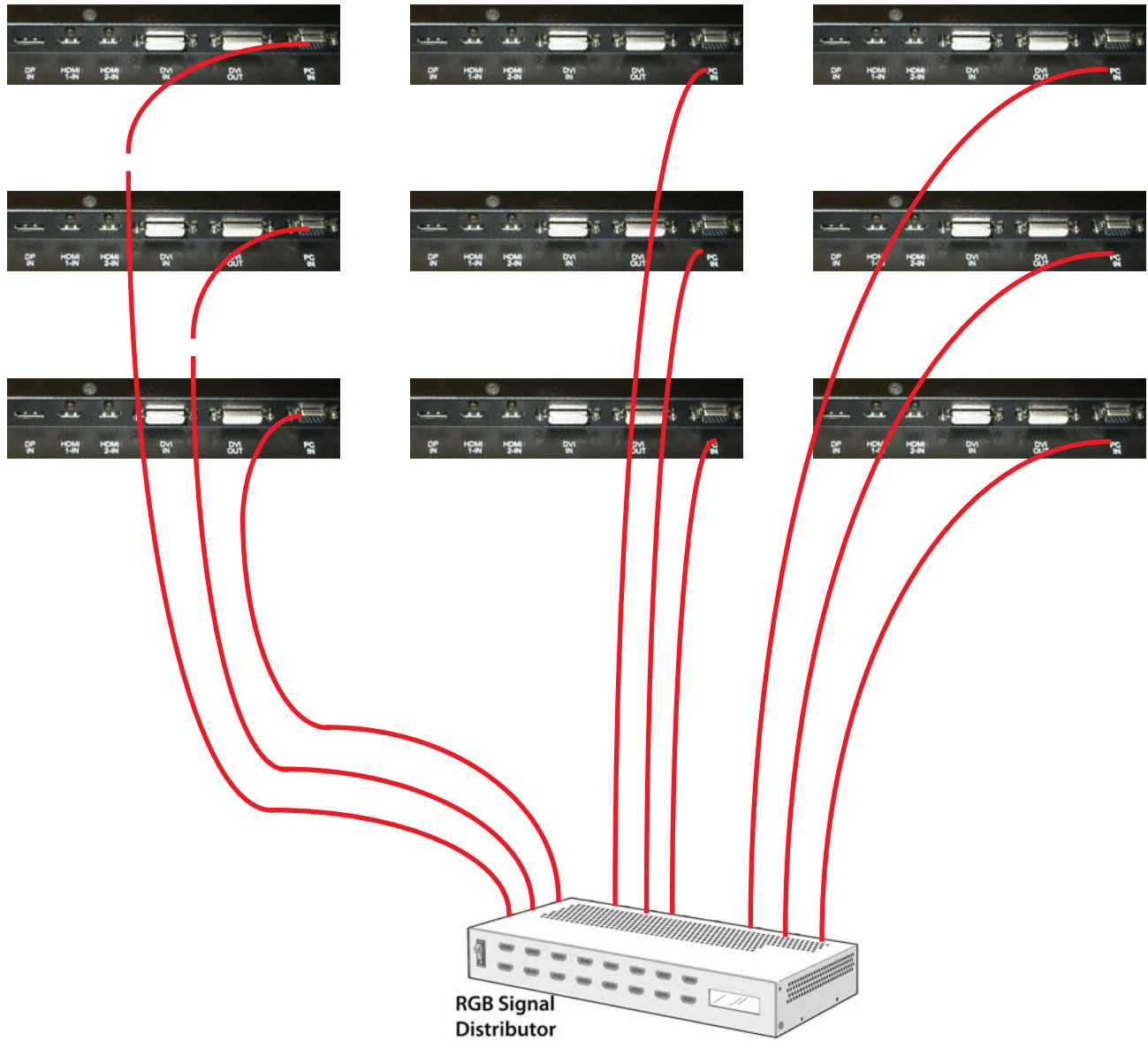
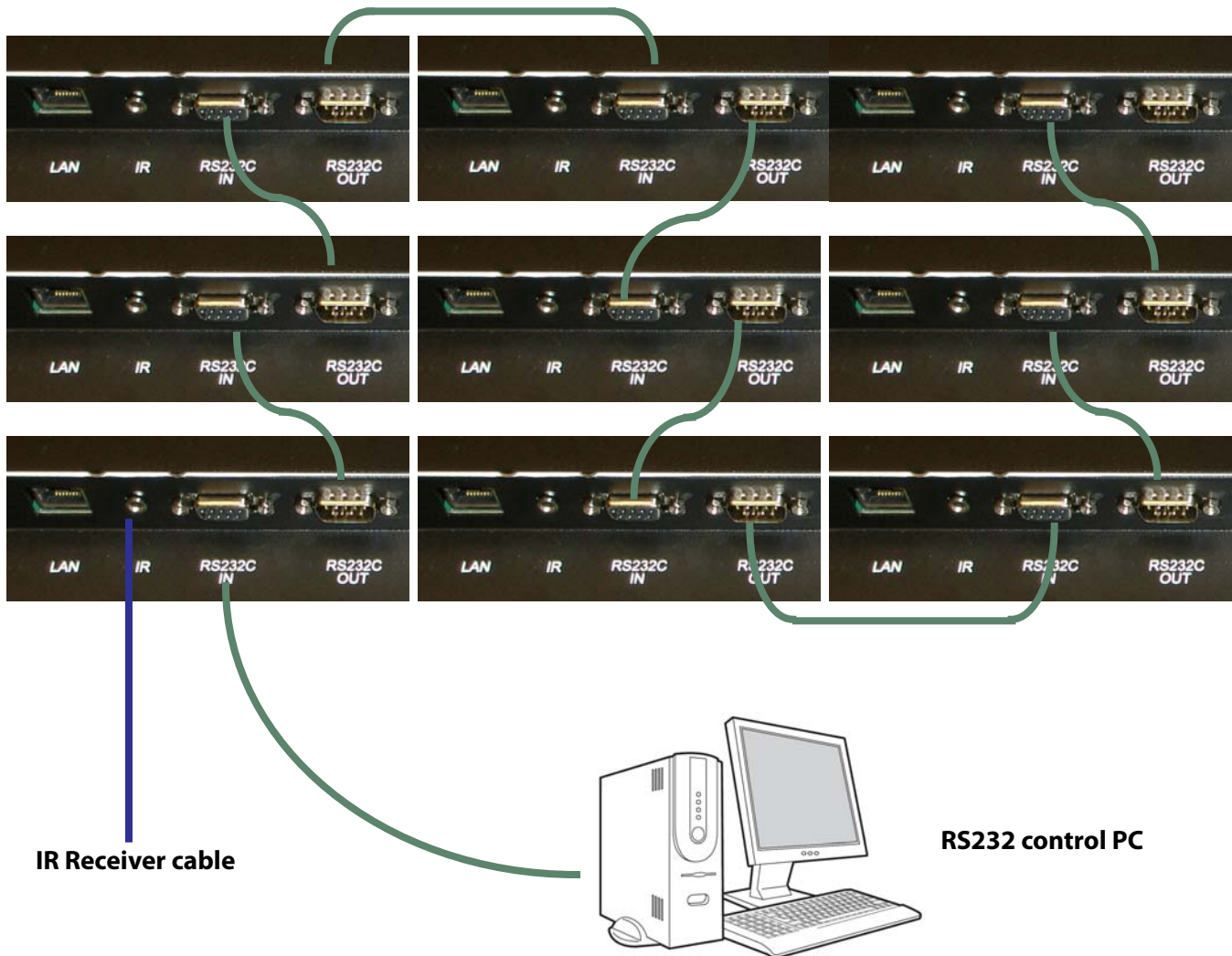

Image quality can be affected by cable or signal quality.

Connecting For Remote Control

Connecting RS232 Cable and IR Receiver



The maximum for RS232 with daisy chain connection is 30 sets. If you need additional connection, use an RS232 distributor.

The IR command for power on/off is looped through all the displays. All other commands from the IR remote are *not* looped through, and the IR Receiver cable must be connected to the specific unit you want to control.

Connecting Ethernet Cable

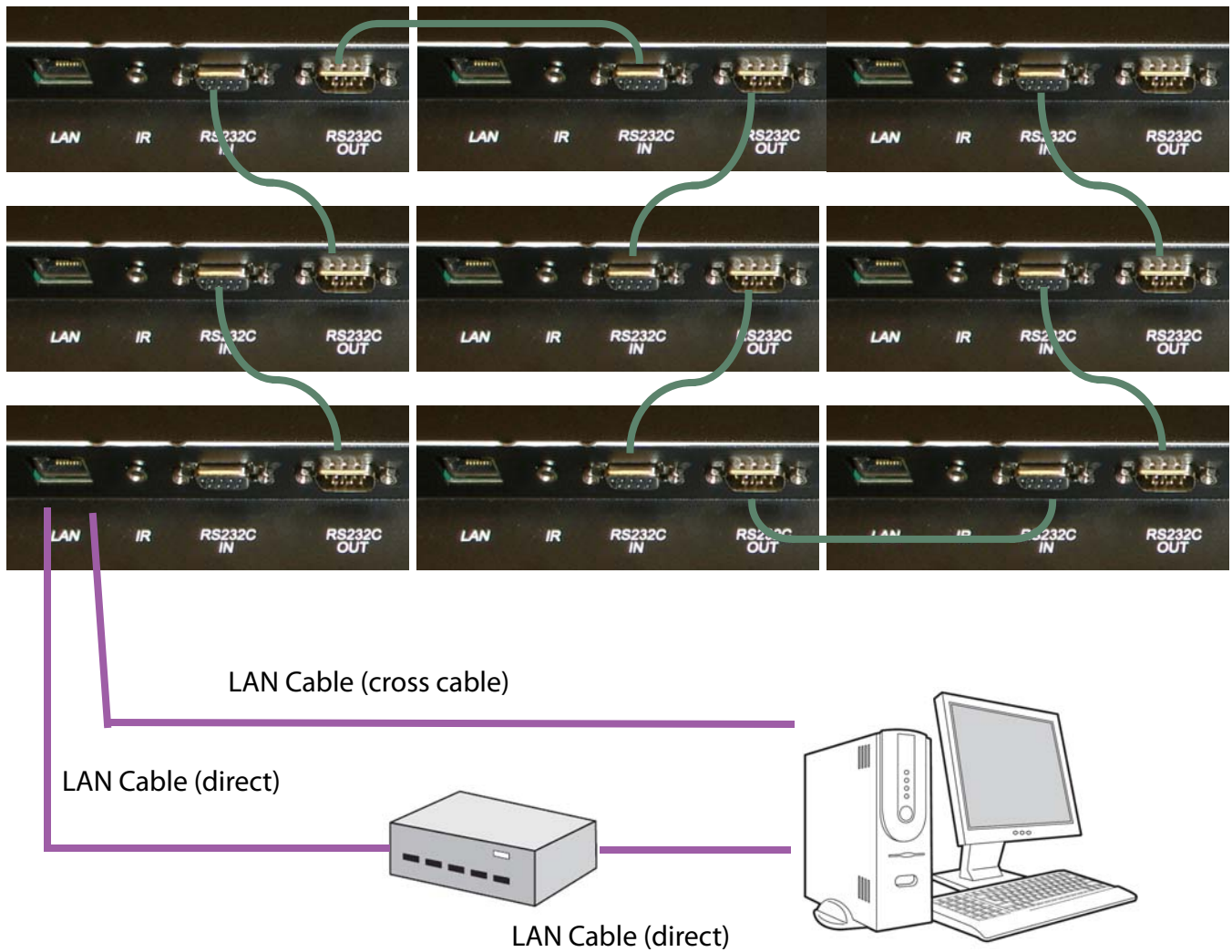

The control PC should be connected to one of the PS5580s with Ethernet cable. For connection between PS5580s, use RS232C cables.

Operation

How to use the Remote Control

1 MENU button

- Press MENU button to display the MENU.
- Press again to move from sub menu to main menu.



2 Direction buttons and OK button

- ◀▶ select the highlighted item or move from one menu to another horizontally.
- ▼▲ buttons move the highlighted area up or down to select adjustment items within the menu.



3 EXIT button

- Press EXIT button to exit from the MENU

4 INFO button

- This displays, in the upper left corner of the screen, the display information at the moment. (The illustration here is one example.)

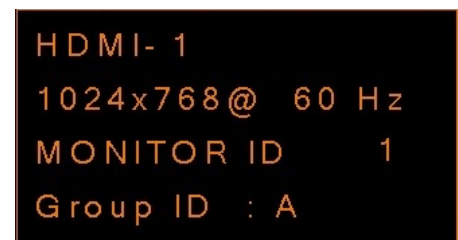

Configuration

Picture Mode



- 1 Press MENU button to display the MENU on the screen.
- 2 Select PICTURE menu.
 - Press ▼▲ to move to PICTURE menu.
 - Then press OK to go into the PICTURE MENU.
- 3 Select the sub-menu.
 - Press ▼▲ to move to the sub-menu.
 - Press OK to select a sub-menu.
- 4 Adjust the value
 - Each of the values can be adjusted by pressing ▼▲
- 5 Exit from the MENU.
 - Press EXIT button to get out of the MENU.
- 6 Move the Main MENU.
 - Press MENU button to move the Main MENU.



Picture Adjustments

Menu Item	Adjusts this
BRIGHTNESS	Overall image and background brightness
BACKLIGHT	Backlight intensity
CONTRAST	Image brightness relative to background
SHARPNESS	Crispness of the image
TINT	Adjusts red to green color
COLOR ¹	Saturation or the depth of color
COLOR TEMPERATURE	Select 4000K, 6500K, 10000K or USER
COLOR BALANCE	Individual adjustment of R, G, B, Gains and Offsets
GAMMA SELECTION	Gamma 1.8 or Gamma 2.2
PICTURE RESET	Initialize all values to factory defaults
COLOR SPACE	Select AUTO, RGB PC, or RGB VIDEO

¹For color adjustments, see "Color Balancing the Wall" on page 26.

Screen A Mode (for PC In)



- 1 Press MENU button to display the MENU on the screen.
 - Select SCREEN menu.
 - Press ▼▲ to move to SCREEN menu.
 - Then press OK to go into the SCREEN menu.
- 2 Select the sub-menu.
 - Press ▼▲ to move to the sub-menu.
 - Press OK to select a sub-menu.
- 3 Adjust the value
 - Each of the values can be adjusted by pressing ▼▲
- 4 Exit from the MENU.
 - Press EXIT button to get out of the MENU.
- 5 Move the Main MENU.
 - Press MENU button to move the Main MENU

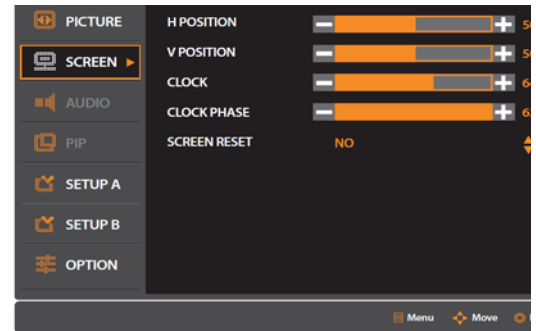

Screen A Mode Adjustments

Menu Item	Adjusts this
H POSITION	Adjusts the horizontal position of the display image on the screen
V POSITION	Adjusts the vertical position of the display image on the screen
CLOCK	Adjusts the width of the display image on the screen
CLOCK PHASE	Adjusts the "noise" on the image
SCREEN RESET	Initializes all these values to factory default

Setup A Menu

- 1 Press MENU button to display the MENU on the screen.
- 2 Select SETUP A menu. Press ▼▲ to move to SETUP A menu. Then press OK to go into the SETUP A menu.
- 3 Select the sub-menu.
 - Press ▼▲ to move to the sub-menu.
 - Press OK to select a sub-menu.
- 4 Adjust the value
 - Each of the values can be adjusted by pressing ▼▲
- 5 Exit from the MENU.
 - Press EXIT button to get out of the MENU.
- 6 Move the Main MENU. Press MENU button to move the Main MENU.

Setup A Adjustments

Menu Item	Adjusts this
AUTO SETUP	Screen size, H & V positions, Clock & Clock Phase, all adjusted
AUTO ADJUST (for PC In)	Select YES or NO for AUTO ADJUST (Screen Size, H position, V position, Clock, Clock Phase will be adjusted)
POWER SAVE	Select time delay for Power Save, or Off for no power save. Monitor will automatically power off after the selected time.
AUTO POWER	Select YES or NO for AUTO POWER (Monitor will automatically power on when power is available.)
KEY LOCK	LOCK -- Key buttons will not work. NORMAL -- Key buttons will work. Select LOCK or NORMAL with ▼▲ Move to LOCK and press OK to activate Key Lock. To deactivate, move to NORMAL and press OK
STANDBY MODE	Set ON or OFF
SETUP A RESET	Initialize all these values to factory defaults
VERSION	Shows current firmware version

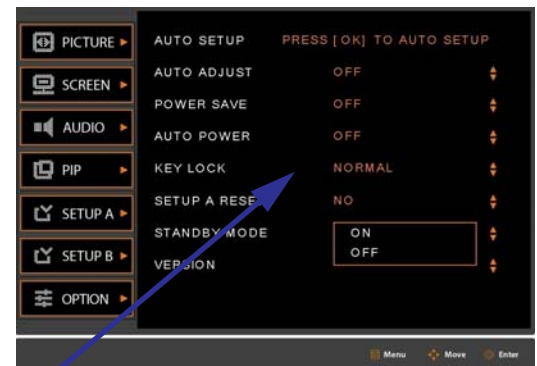

Setup B Menu



- 1 Press MENU button to display the MENU on the screen.
- 2 Select SETUP B menu. Press ▼▲ to move to SETUP B menu. Then press OK to go into the SETUP B menu.
- 3 Select the sub-menu.
 - Press ▼▲ to move to the sub-menu.
 - Press OK to select a sub-menu.
- 4 Adjust the value
 - Each of the values can be adjusted by pressing ▼▲
- 5 Exit from the MENU.
 - Press EXIT button to get out of the MENU.
- 6 Move the Main MENU.
- 7 Press MENU button to move the Main MENU.



Setup B Adjustments

Menu Item	Adjusts this
SERIAL CONTROL	Select LAN ON or LAN OFF
LAN SETTING	Configure the IP address of the set for control via Ethernet
OSD TURN OFF H POSITION V POSITION ROTATION (of OSD) INFO DISPLAY	Configures the OSD menu display Turns off OSD after 5-120 sec of inactivity OSD H position on screen OSD V position on screen Rotates OSD only to landscape/portrait Select to display, or not, the information OSD. The information will be displayed when the input signal or source are changed and give warning when the signal is out of range. The displaying interval can be selected in the range 3-10 sec.
TRANSPARENCY	Set the transparency of the OSD
OFF TIMER	Power off after 1 to 24 hours
SETUP B RESET	Initialize previously adjusted values of this menu
FACTORY RESET	Initialize to factory defaults. All configurations will be initialized.

Options



- 1 Press MENU button to display the MENU on the screen.
- 2 Select OPTION menu. Press ▼▲ to move to OPTION menu. Then press OK to go into the OPTION menu.
- 3 Select the sub-menu. Press ▼▲ to move to the sub-menu. Press OK.
- 4 Press MENU button to move the Main MENU.

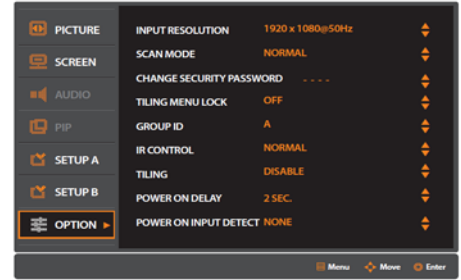

Option Menu Adjustments

Menu Item	Adjusts This
INPUT RESOLUTION	Displays the current input resolution
SCAN MODE	Normal or Overscan Some video formats require different scanning modes to display the image best.
CHANGE SECURITY PASSWORD	This password is applied to the TILING MENU LOCK MENU. The factory preset password is 9999.
TILING MENU LOCK	Locks the tiling menu to protect the tiling display setting.
GROUP ID	Setup the Tiling Group, A through J.
IR control	Prevents the display from being controlled by the remote controller. To return to normal operation, press the ENT button on the KEY PAD for 3 sec.
Tiling	Expands one image over multiple screens. Select ENABLE and press OK. Select ON and press OK. Select H Monitors and press OK, then select the number of Horizontal Monitors and press OK. Select V Monitors and press OK, then select number of Vertical Monitors and press OK. Select Monitor ID and press OK. Select the ID for each monitor and press OK. Select FRAME COMP and press OK.
Power on delay	Adjust the delay time between being in "standby" mode and entering "power on" mode. Range: 2-5 sec.
Power on input detect	Select the default input source for power on.

Color Balancing the Wall

If you have only one display, you do not need to go through this section. If you have a wall of displays, you will want them to display the same colors throughout the wall.

Color Temperature

Different “pure white” light sources do not always have the same color. For instance, light from an incandescent bulb has more yellow than light from direct sunlight. “Color Temperature” is a way of measuring these color differences. In general, higher color temperature numbers are bluer or “cooler.”

To adjust Color Temperature,

- 1** Reset all the displays to a nominal value. For *each* display in the wall, do the following:
 - a** Press the MENU button to display the menu on the screen.
 - b** Select PICTURE and press OK.
 - c** Select BACKLIGHT and press OK. Adjust Backlight to 80.
 - d** Select COLOR BALANCE and set
 - all three GAINS to 50
 - all three RGB GAINS to 100
 - all three RGB OFFSETS to 50
 - e** Select COLOR TEMPERATURE and set it to USER.
- 2** Using either a meter or your eye, find the dimmest unit. You must adjust all the other displays in the wall to match this one.
- 3** Adjust the backlight levels of all the *other* displays to match as closely as possible to this dimmest display.
- 4** Use the RGB GAIN of each display to make the colors match.
 - a** Choose one of the displays that looks “whitest” and match the others to this one. Always match a display to one that is next to it (left-or-right or above-or-below).
- 5** Display a 50% gray screen by lowering the backlight values, and adjust the RGB OFFSETS so they match.
- 6** Match the brightness again with the backlight controls.

Supported Input Signal Resolution

DTV signals (EDTV, HDTV) are not supported in PC Input.

Timing	fH (kHz)	fV (Hz)	Dot Clock (MHz)	HDMI	VGA	DVI	DisplayPort
VGA 640 x 480	31.469	60	25.175	✓	✓	✓	✓
SVGA 800 x 600	30.998	50	30.75	✓	✓	✓	✓
	37.879	60	40	✓	✓	✓	✓
XGA 1024 x 768	48.363	60	65	✓	✓	✓	✓
1280 x 768	47.776	60	79.5	✓	✓	✓	✓
1280 x 960	60	60	108	✓	✓	✓	✓
SXGA 1280 x 1024	52.679	50	88.5	✓	✓	✓	✓
	63.981	60	108	✓	✓	✓	✓
1360 x 768	39.564	50	69	✓	✓	✓	✓
1360 x 768	47.712	60	85.5	✓	✓	✓	✓
WXGA 1366 x 768	50	60	80	✓	✓		
1400 x 1050	65.317	60	121.750	✓	✓	✓	✓
1600 x 900	46.394	50	96.5	✓	✓	✓	✓
	55.990	60	118.250	✓	✓	✓	✓
UXGA 1600 x 1200	61.795	50	131.5	✓	✓	✓	✓
	75	60	162	✓	✓	✓	✓
480p	31.469	60	27	✓	✓	✓	✓
576p	31.250	50	27	✓	✓	✓	✓
720p50	37.5	50	74.250	✓	✓	✓	✓
720p60	45	60	74.250	✓	✓	✓	✓

Timing	fH (kHz)	fV (Hz)	Dot Clock (MHz)	HDMI	VGA	DVI	DisplayPort
1080i50	28.125	50	74.250	✓	✓	✓	✓
1080i60	33.750	60	74.250	✓	✓	✓	✓
1080p50	56.250	50	148.5	✓	✓	✓	✓
1080p60	67.5	60	148.5	✓	✓	✓	✓

Specifications

Item	Specification
Back Light Unit Type	LED
Active Display area (H x V)	1209.6 x 680.4 mm
Aspect Ratio	16:9
Number of pixels	1920 (H) x 1080 (V)
Pixel Pitch	0.630 x 0.630 mm
Display Colors	1.07 Billion
Luminance of White	400 cd/m ²
Contrast Ratio (dark room)	4000: 1
Bezel	7 / 6 / 6 / 6 (U/D/L/R) mm
Power Supply	AC 100V - 240V (50/60Hz)
Power Consumption	Max: 125W Typical: 120W Stand-by: <1.0W
Surface Treatment	Haze 0% / Hard coating 2H
Viewing Angle	H: 178°, V: 178°
Response Time (G to G)	8msec (typical)
Environmental Condition	Temperature: 5° - 35° C Humidity: 35% - 75%
Input Signal	Supported Resolution: VGA, SVGA, XGA, SVGA, UXGA, WXGA, 480p, 576p, 720p(50/60), 1080i(50/60), 1080p(50/60) HDCP: Compliant with High-bandwidth Digital Content Protection (HDCP) using DVI and HDMI 1.3a standards Frequency: H: 31.5-75 Hz, V: 50, 60Hz
Input/Output Terminal	Input: DP x 1, HDMI x 2, DVI x 1 PC x 1, RS232C x 1, LAN x 1, IR x 1 Output: DVI x 1, RS232C x 1
Lamp Life	Min 35,000 hrs (Ta: 25 ±2°C)
Dimensions (W x H x D)	1224.2 x 696.0 x 50.0 mm
Weight	21kg (±0.5kg)

Dimensions

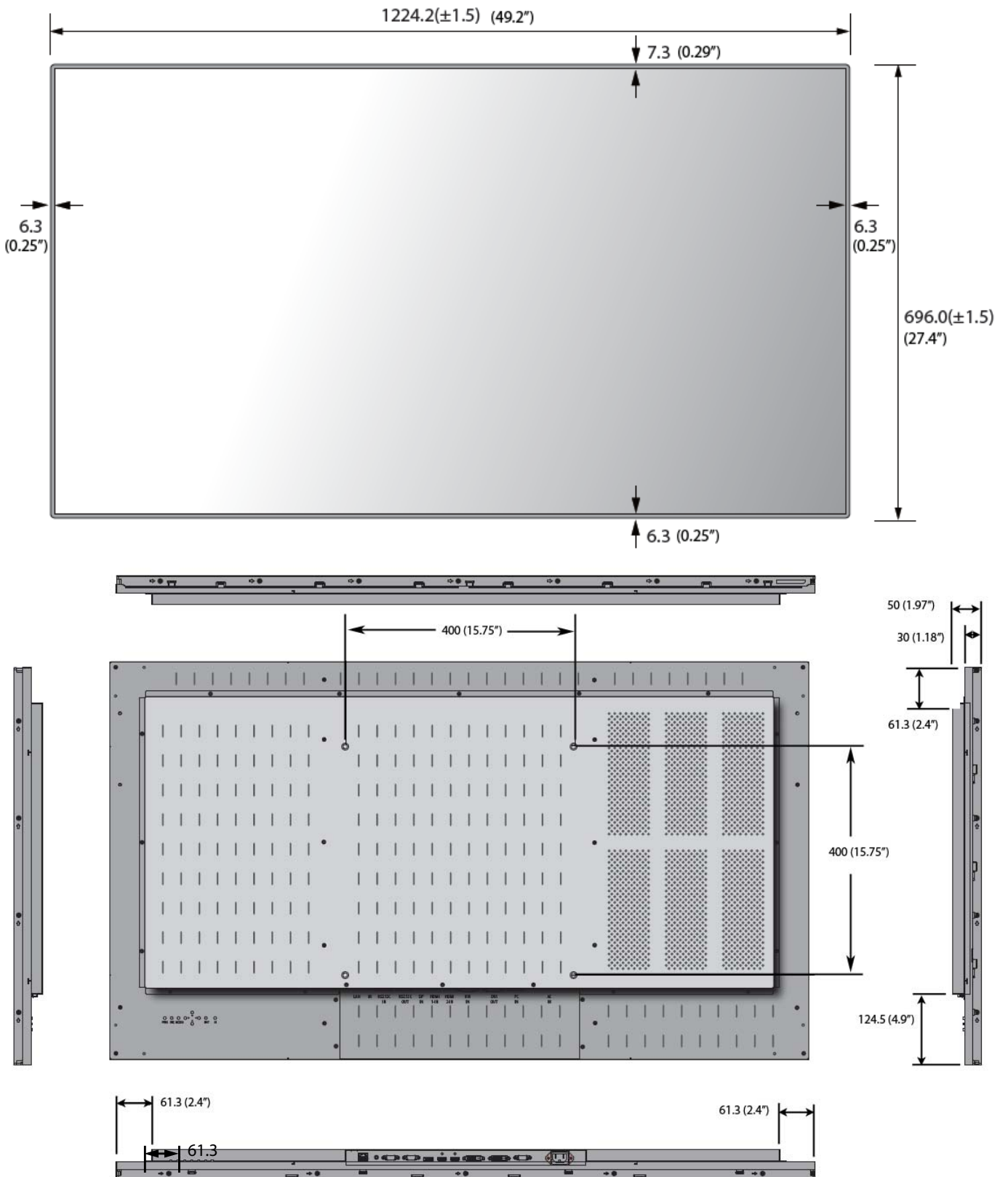

Regulatory Information

Manufacturer's Name: Planar Systems, Inc.
Manufacturer's Address: 1195 NW Compton Drive
Beaverton, OR 97006

Declares that the product Model Numbers: PS5580

Conforms with the provisions of:

Council Directive 2004/108/EC on Electromagnetic Compatibility;

EN55022:2010 Radiated and Conducted Emissions from IT Equipment

EN55024:1998 Immunity of IT Equipment

Including:	EN61000-4-2	Electrostatic Discharge
	EN61000-4-3	Radiated Immunity
	EN61000-4-4	Electrical Fast Transients
	EN61000-4-5	Line Surge
	EN61000-4-6	RF Conducted Susceptibility
	EN61000-4-8	Magnetic Field Immunity
	EN61000-4-11	Voltage Dips and Interrupts

And:	EN61000-3-2	Harmonic Current Emissions
	EN61000-3-3	Voltage fluctuations and Flicker

Council Directive 2006/95/EC on Low Voltage Equipment Safety:

EN60950:2006+A11 Safety of IT Equipment

The Technical Construction File required by this Directive is maintained at the corporate headquarters of Planar Systems, Inc., 1195 NW Compton Drive, Beaverton, OR 97006.

Note: This equipment has been tested and found to comply with the limits for a Class A digital device, pursuant to part 15 of the FCC Rules. These limits are designed to provide reasonable protection against harmful interference when the equipment is operated in a commercial environment. This equipment generates, uses, and can radiate radio frequency energy and, if not installed and used in accordance with the instruction manual, may cause harmful interference to radio communications. Operation of this equipment in a residential area is likely to cause harmful interference in which case the user will be required to correct the interference at his own expense.

Industry Canada (ICES-003): This Class A digital apparatus complies with Canadian ICES-003.

Cet appareil numérique de la classe A est conforme à la norme NMB-003 du Canada.

Any changes or modifications to the display not expressly approved by Planar could void the user's authority to operate this equipment.

Other Certifications

CISPR 22

Customer Support Information

24/7 Online Technical Support is available at <http://www.planar.com/support>

Customer Support Contact Information and Hours of Operation

Tel: 1-866-PLANAR1 (866-752-6271) or +1 503-748-1100

Hours: M-F, 8am - 8pm Eastern Time | M-F, 5am - 5pm Pacific Time

Warranty and Service Plans

Planar warranty and service plans will help you maximize your investment by providing great support, display uptime, and performance optimization. From post-sale technical support to a full suite of depot services, our services are performed by trained Planar employees. When you purchase a Planar product, you get more than a display, you get the service and support you need to maximize your investment. To find the latest warranty and service information regarding your Planar product, please visit: http://www.planar.com/support/warranty/standard_warranties/

Warranty Features

- 3-year protection from defects in material and workmanship
- Advanced shipment of replacement part or product
- Access to 24x7 emergency phone support
- Please visit: http://www.planar.com/support/warranty/standard_warranties/ for a full warranty review

© 2013 Planar Systems, Inc. Planar is a registered trademark of Planar Systems, Inc.

Other brands and names are the property of their respective owners.

Technical information in this document is subject to change without notice.

Index

A

accessories
 checking, 8
avoiding temporary image retention, 6

B

burn-in, 6

C

certifications, 31
color balancing the wall, 26
color temperature, 26
configuration, 21
 options, 25
 picture mode, 21
 screen A mode, 22
 setup A menu, 23
 setup B menu, 24
conformity information, 31
connecting cables, 18
connecting cables, vesa mounting, 10
customer support
 hours of operation, 32
 phone numbers, 32
 website, 32

D

dimensions, 30
document number, ii

E

environmental conditions, 4

H

handling the display, 7
hours of operation for customer support, 32

I

information
 regulatory, 31
input ports, 12
input signal resolution, supported types, 27
installation
 checklist, 8

M

manufacturer's address, 31
menus
 options, 25
 picture, 21
 screen A, 22
 setup A, 23
 setup B, 24

N

normal use thermal guidelines, 6

O

operating conditions, 4
options, 25

P

picture mode, 21

R

regulatory information, 31
remote control, 13
 using, 20
resolution, supported types, 27
rs232 commands, see rs232 manual, ii

S

safety information, 2
screen A mode, 22
service plans, ii, 32
setup A menu, 23
setup B menu, 24
specifications, 29
supported resolutions, 27

T

telephone numbers for customer support, 32
temperature
 requirements for normal use, 6
temporary image retention
 avoiding, 6
 definition, 6
thermal guidelines, 6
TIR *see temporary image retention*

U

unpacking accessories, 8

W

wall
 color balancing, 26
warranty information, ii, 32