

JVC®

**For models:
AV-56WP30
AV-48WP30**

PROJECTION TELEVISION USER'S GUIDE







IMPORTANT NOTE TO THE CUSTOMER

In the spaces below, enter the model and serial number of your television (located at the rear of the television cabinet). Staple your sales receipt or invoice to the inside cover of this guide. Keep this user's guide in a convenient place for future reference. Keep the carton and original packaging for future use.

Serial Number

Model Number
LCT1237-001A-A
0402-TN-FAA-JIM

IMPORTANT SAFETY PRECAUTIONS

	CAUTION RISK OF ELECTRIC SHOCK DO NOT OPEN	
<p>CAUTION: To reduce the risk of electric shock. Do not remove cover (or back). No user serviceable parts inside. Refer servicing to qualified service personnel.</p>		
	<p>The lightning flash with arrowhead symbol, within an equilateral triangle is intended to alert the user to the presence of uninsulated “dangerous voltage” within the product’s enclosure that may be of sufficient magnitude to constitute a risk of electric shock to persons.</p>	
	<p>The exclamation point within an equilateral triangle is intended to alert the user to the presence of important operating and maintenance (servicing) instructions in the literature accompanying the appliance.</p>	

WARNING: TO PREVENT FIRE OR SHOCK HAZARDS, DO NOT EXPOSE THIS TV SET TO RAIN OR MOISTURE.

CAUTION: TO INSURE PERSONAL SAFETY, OBSERVE THE FOLLOWING RULES REGARDING THE USE OF THIS UNIT.

- 1) Operate only from the power source specified on the unit.
- 2) Avoid damaging the AC plug and power cord.
- 3) Avoid Improper installation and never position the unit where good ventilation is unattainable.
- 4) Do not allow objects or liquid into the cabinet openings.
- 5) In the event of trouble, unplug the unit and call a service technician. Do not attempt to repair it yourself or remove the rear cover.

Changes or modifications not approved by JVC could void the warranty.

* When you don't use this TV set for a long period of time, be sure to disconnect both the power plug from the AC outlet and antenna for your safety.

* To prevent electric shock do not use this polarized plug with an extension cord, receptacle or other outlet unless the blades can be fully inserted to prevent blade exposure.

IMPORTANT SAFEGUARDS

CAUTION:

Please read and retain for your safety.

Electrical energy can perform many useful functions. This TV set has been engineered and manufactured to assure your personal safety. But **improper use can result in potential electrical shock or fire hazards!** In order not to defeat the safeguards incorporated in this TV set, observe the following basic rules for its installation, use and servicing. And also follow all warnings and instructions marked on your TV set.

INSTALLATION

- 1) Your TV set is equipped with a polarized AC line plug (one blade of the plug is wider than the other).

(POLARIZED-TYPE)

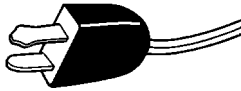

This safety feature allows the plug to fit into the power outlet only one way. Should you be unable to insert the plug fully into the outlet, try reversing the plug. Should it still fail to fit, contact your electrician.

- 2) Operate the TV set only from a power source as indicated on the TV set or refer to the operating instructions for this information. If you are not sure of the type of power supply to your home, consult your TV set dealer or local power company. For battery operation, refer to the operating instructions.
- 3) Overloaded AC outlets and extension cords are dangerous, and so are frayed power cords and broken plugs. They may result in a shock or fire hazard. Call your service technician for replacement.
- 4) Do not allow anything to rest on or roll over the power cord, and do not place the TV set where power cord is subject to traffic or abuse. This may result in a shock or fire hazard.
- 5) Do not use this TV set near water — for example, near a bathtub, washbowl, kitchen sink, or laundry tub, in a wet basement, or near swimming pool, etc.
- 6) If an outside antenna is connected to the TV set, be sure the antenna system is grounded so as to provide some protection against voltage surges and built-up static charges. Section 810 of the National Electrical Code provides information with respect to proper grounding of the mast and supporting structure, grounding of the lead-in wire to an antenna discharge unit, size of grounding conductors, location of antenna discharge unit, connection requirements for the grounding electrode.

IMPORTANT RECYCLING INFORMATION

This product utilizes both a Cathode Ray Tube (CRT) and other components that contain lead. Disposal of these materials may be regulated in your community due to environmental considerations. For disposal or recycling information, please contact your local authorities, or the Electronic Industries Alliance: <http://www.eiae.org>

- 7) An outside antenna system should not be located in the vicinity of overhead power lines or other electric light or power circuits, or where it can fall into such power lines or circuits. When installing an outside antenna system, extreme care should be taken to keep from touching such power lines or circuits as contact with them might be fatal.

**EXAMPLE OF ANTENNA GROUNDING
AS PER NATIONAL ELECTRICAL CODE**

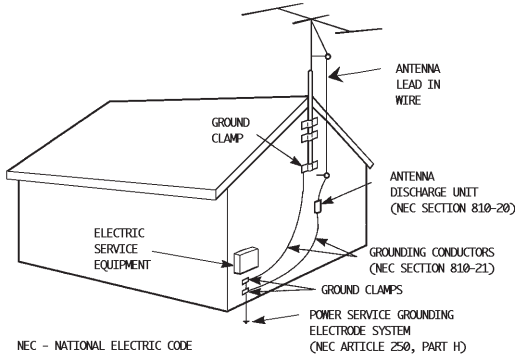

- 8) TV sets are provided with ventilation openings in the cabinet to allow heat generated during operation to be released.
Therefore:
— Never block the bottom ventilation slots of a portable TV set by placing it on a bed, sofa, rug, etc.
— Never place a TV set in a “built-in” enclosure unless proper ventilation is provided.
— Never cover the openings with a cloth or other material.
— Never place the TV set near or over a radiator or heat register.
- 9) To avoid personal injury:
— Do not place a TV set on a sloping shelf unless properly secured.
— Use only a cart or stand recommended by the TV set manufacturer.
— Do not try to roll a cart with small casters across thresholds or deep pile carpets.
— Wall or shelf mounting should follow the manufacturer’s instructions, and should use a mounting kit approved by the manufacturer.

USE

- 10) Caution children about dropping or pushing objects into the TV set through cabinet openings. Some internal parts carry hazardous voltages and contact can result in a fire or electrical shock.
- 11) Unplug the TV set from the wall outlet before cleaning. Do not use liquid or an aerosol cleaner.
- 12) Never add accessories to a TV set that has not been designed for this purpose. Such additions may result in a hazard.

- 13) For added protection of the TV set during a lightning storm or when the TV set is to be left unattended for an extended period of time, unplug it from the wall outlet and disconnect the antenna. This will prevent damage to product due to lightning storms or power line surges.
- 14) A TV set and cart combination should be moved with care. Quick stops, excessive force, and uneven surfaces may cause the TV set and cart combination to overturn.



SERVICE

- 15) Unplug this TV set from the wall outlet and refer servicing to qualified service personnel under the following conditions:
 - A. When the power cord or plug is damaged or frayed.
 - B. If liquid has been spilled into the TV set.
 - C. If the TV set has been exposed to rain or water.
 - D. If the TV set does not operate normally by following the operating instructions. Adjust only those controls that are covered in the operating instructions as improper adjustment of other controls may result in damage and will often require extensive work by a qualified technician to restore the TV set to normal operation.
 - E. If the TV set has been dropped or damaged in any way.
 - F. When the TV set exhibits a distinct change in performance — this indicates a need for service.
- 16) Do not attempt to service this TV set yourself as opening or removing covers may expose you to dangerous voltage or other hazards. Refer all servicing to qualified service personnel.
- 17) When replacement parts are required, have the service technician verify in writing that the replacement parts he uses have the same safety characteristics as the original parts. Use of manufacturer's specified replacement parts can prevent fire, shock, or other hazards.
- 18) Upon completion of any service or repairs to this TV set, please ask the service technician to perform the safety check described in the manufacturer's service literature.
- 19) When a TV set reaches the end of its useful life, improper disposal could result in a picture tube implosion. Ask a qualified service technician to dispose the TV set.
- 20) Note to CATV system installer.

This reminder is provided to call the CATV system installer's attention to Article 820-40 of the NEC that provides guidelines for proper grounding and, in particular, specifies that the cable ground shall be connected to the grounding system of the building, as close to the point of cable entry as practical.

Table of Contents

Unpacking Your Television . . . 8

Quick Setup 9

CONNECTIONS 12

Front Panel Diagram 12

Rear Panel Diagram 12

Connecting to Cable or an Antenna 13

Cable and VCR Connections 14

Connecting to a DVD Player,
DTV Decoder and D-VHS 15

Connecting to a Digital
TV Receiver w/HDCP 16

Connecting to a DVD Player 17

Connecting to JVC AV Compu Link III . . . 18

Connecting Devices to the Front Panel . . 19

Connecting to an External Amplifier . . . 20

Connecting to the Surround Amplifier . . . 20

Remote Control 21

Installing the batteries 21

Remote Control Basics 21

Remote Programming 22

Setting CATV, VCR, and DVD Codes . . . 22

Cable Box or Satellite Setup 22

VCR Setup 23

DVD Setup 24

Search Codes 25

Onscreen Menus 26

Onscreen Menu System 26

Using the Onscreen Menus 27

Plug In Menu 28

 Language 28

 Auto Tuner Setup 29

 Set Clock 30

 Auto 30

 Manual 30

 Finish 30

Initial Setup 31

 Auto Tuner Setup 31

 Auto Demo 31

 Channel Summary 32

 Channel Summary – Lock 32

 Channel Guard Message 32

Onscreen Menus (Continued)

V-Chip 33

 US Rating System 33

 Viewing Guidelines 33

 MPAA Ratings 34

 Set Ratings Guidelines 35

 To Set TV Ratings Levels 35

 To Set Movie Ratings Levels 36

 Unrated Programs 36

 Warning Message 36

 Canadian V-Chip Ratings 37

 Set Lock Code 38

Initial Setup 2 39

 Language 39

 Closed Caption 39

 Front Panel Lock 40

 Auto Shut Off 41

 Digital-In 41

Picture Adjust 42

 Tint 42

 Color 42

 Picture 43

 Bright 43

 Detail 43

Picture Adjust 2 44

 Color Temperature 44

 Dig. Noise Clear 44

 Noise Muting 44

Sound Adjust 45

 Bass 45

 Treble 45

 Balance 45

 MTS 46

 Sound Advice 46

Clock /Timers 47

 Clock Timers 47

 Set Clock 47

 On/Off Timer 47

 Setting the On/Off Timer 48

Initial Setup 3 49

 Vertical Position 49

 Center Ch Input 50

 XDS ID 50

 Power Indicator 50

Aspect 51

 Aspect 51

 Aspect Ratios 51

Adjusting CRT Color Convergence 52

Table of Contents

Button Functions 53

SPLIT	53
SWAP	53
FREEZE	53
SELECT	53
ENTER	53
INDEX	54
POP	54
MENU	55
EXIT	55
DISPLAY	55
SLEEP TIMER	55
BBE	56
HYPER SURROUND	56
MUTING	56
VIDEO STATUS	56
NATURAL CINEMA	56
ASPECT	56
NUMBER BUTTONS – 10 KEY PAD	57
100+ BUTTON	57
RETURN+	57
V-CHIP	57
INPUT	58
MENU (On TV's Front Panel)	58
LIGHT	58
VCR BUTTONS	59
DVD BUTTONS	59
TV/CATV SWITCH	59
VCR/DVD SWITCH	59

Appendices 60

Troubleshooting	60
Appendix A	62
Limited Warranty	63
Authorized Service Centers	65
Specifications	66

Unpacking Your Television

Thank you for your purchase of JVC's model AV-56WP30 or AV-48WP30 Color Television. Before you begin setting up your new television, please check to make sure you have all of the following items. In addition to this guide, your television box should include:

1 Television

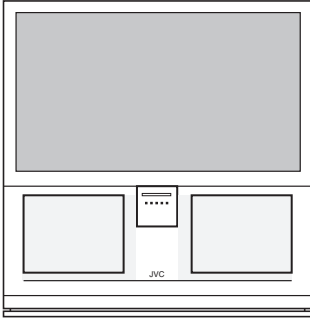

1 Remote Control

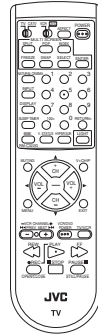

2 AA Batteries

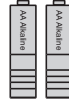

Once you have unpacked your television, the next step is to connect it to your antenna/cable or satellite system and to connect the audio/video devices you want to use with your television. To make these connections you will use plugs like the ones illustrated below.



RF Connectors

Used to connect a coaxial cable from an external antenna or Cable TV system.

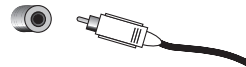

A/V Input Plug

Used to connect audio/video devices like VCRs, DVD players, stereo amplifiers, game consoles, etc.



S-Video Plug

Used to make video connections with VCRs, DVDs, Camcorders, etc (optional).



AV Compu Link Cable

Used to connect JVC AV Compu Link capable components for an automated home theater.

We recommend that before you start using your new television, you read your entire User's Guide so you can learn about your new television's many great features. But if you're anxious to start using your television right away, a quick setup guide follows on the next three pages.

Quick Setup 1

Getting Started

These quick setup pages will provide you, in three easy steps, with the basic information you need to begin using your new television right away. This information includes basic instructions on operating your remote control, making a simple cable/antenna and optional VCR connection and, finally, information on programming your television's Auto Tuner.

If you have questions, or for more detailed information on any of these steps, please consult other sections of this manual.

Step One - The Remote Control

The remote control is the key to operating your television's many great features. Before you can operate your remote control, you first need to install the batteries (included).

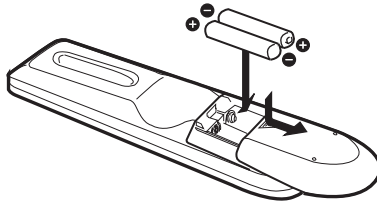

Slide the cover on the back of the remote down towards the bottom of the remote control. Insert two batteries (included) carefully noting the "+" and "-" markings, placing the "-" end in the unit first. Slide the cover back into place.

Basic Operation

Turn the television on and off by pressing the POWER button at the top right corner of the remote.

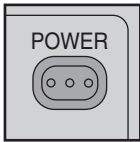

Power Button

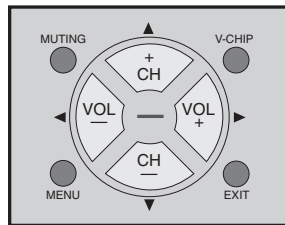

Key Feature Buttons

The four key feature buttons at the center of the remote can be used for basic operation of the television. The top and bottom buttons will scan forward and back through the available channels. The right and left buttons will turn the volume up or down. These buttons are also marked with four arrows and are also used with JVC's onscreen menu system. You will need to use these buttons later in the Quick Setup.

The next step is to connect your television to an antenna or cable.

Proceed to Step Two

Quick Setup 2

Step Two - Making Basic Connections

Next you will need to connect your television to an antenna, VCR or cable system. The most basic VCR and antenna/cable connection is shown below. For more detailed connections, such as ones where a cable box is required, or connecting with a combination of a cable box and VCR, home stereo system, etc., see pages 12 to 20.

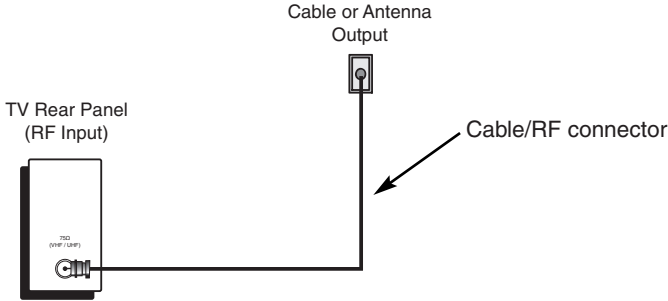

- 1) Connect an RF Cable from the wall outlet into the RF Cable In on the back of the TV.

Connecting to a VCR

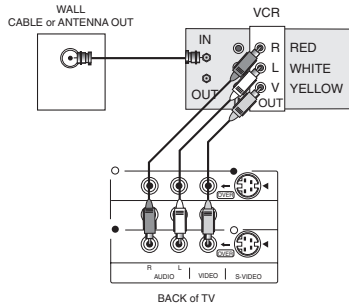

- 1) Connect the Red Cable from VCR Audio Output into the Red TV Audio In.
- 2) Connect the White Cable from VCR Audio Output into the White TV Audio In.
- 3) Connect the Yellow Cable from VCR Output into the Yellow TV Video In, **OR** Connect an RF Cable from VCR RF Cable Out into the RF Cable In on the back of the TV.

NOTE:

- White, Yellow and Red are the most common colors for VCR Cables. Some models may vary in color. Please consult the user's manual for your VCR Player for more information.
- See page 23 for instructions on programming your remote control to operate the basic functions of your VCR Player.

Quick Setup 3

Step Three - The Plug In Menu

When you turn your television on for the first time, the Plug In Menu will appear. This menu sets some of the basic settings for your television. A complete description of the Plug In Menu can be found starting on page 28. We recommend you complete the Plug In Menu items before you start using your television. To begin watching your television right away you only need to run the Auto Tuner Setup. This lets your television learn the channels it is able to receive clearly. To run the Auto Tuner Setup, follow the steps below.

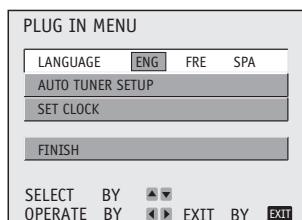

Press the ▲▼ buttons to move to AUTO TUNER SETUP

Press the ◀▶ buttons to begin AUTO TUNER SETUP

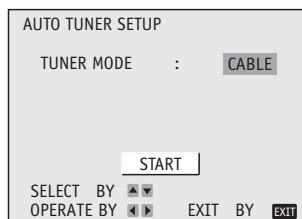

◀▶ To choose CABLE (if you are connected to a cable system) or AIR (if you use an antenna)

▲▼ To move to START

◀▶ To start Auto Tuner Setup

The Auto Tuner will now memorize all of the clear, active channels your television can receive. This will take roughly one or two minutes.



The Auto Tuner is finished when the message PROGRAMMING OVER! appears on screen.

Your Quick Setup is now complete. You can now begin watching your television, or you can continue on in this guide for more information on connecting audio/video devices, programming your remote control, or using the JVC onscreen menu system to customize your television viewing experience.



The Quick Setup is complete

Connections

Front Panel Diagram

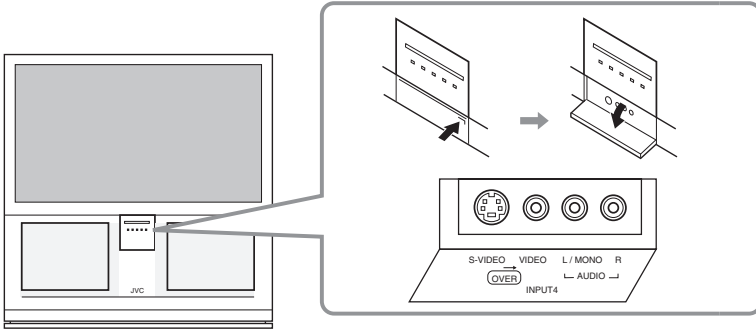

Rear Panel Diagram

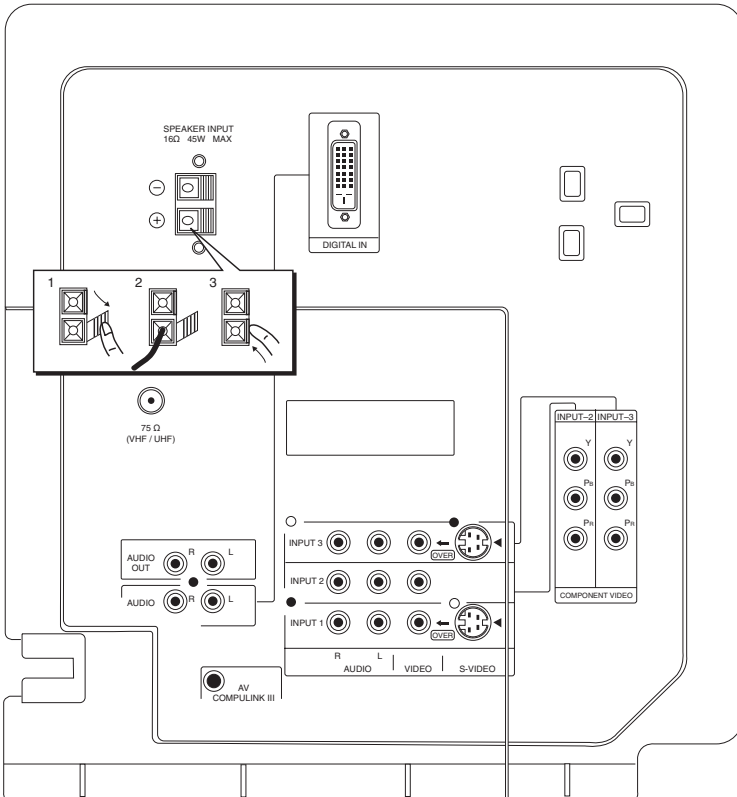

Connecting to Cable or an Antenna

There are three basic types of antenna or cable connections:

- If you have an antenna or have a cable system that does not require you use a cable box to select channels, please refer to **Diagram #1**.
- If you have a cable system that requires the use of a cable box to access all the channels, please refer to **Diagram #2**.
- If you have a cable system that requires the use of a cable box to access certain premium channels, but not “basic” cable channels, please refer to **Diagram #3**.
- For your convenience, connection to a VCR is also shown in the following diagrams. **A VCR is not necessary for operation of the television or Picture OUT or Picture POP function.** You may omit the VCR from your connections if you wish.
- For instructions on connecting a VCR only, please see the Quick Setup on page 10.
- For information on using POP, please see page 54.

Diagram #1

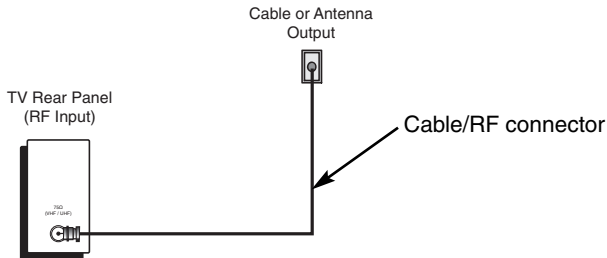

- 1) Connect an RF Cable from the wall outlet into the RF Cable In on the back of the TV.

Connecting to a Cable Box

Diagram #2

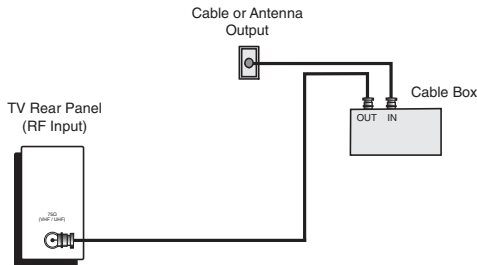

- 1) Connect an RF Cable from the wall outlet into the RF Cable In on the Cable Box.
- 2) Connect an RF cable from the Cable Out on the cable box into the RF Cable In on the back of the TV.

NOTE:

- Please see page 54 for more information on using the POP feature with a cable box.

Connections

Connecting to a Cable Box and VCR

Diagram #3

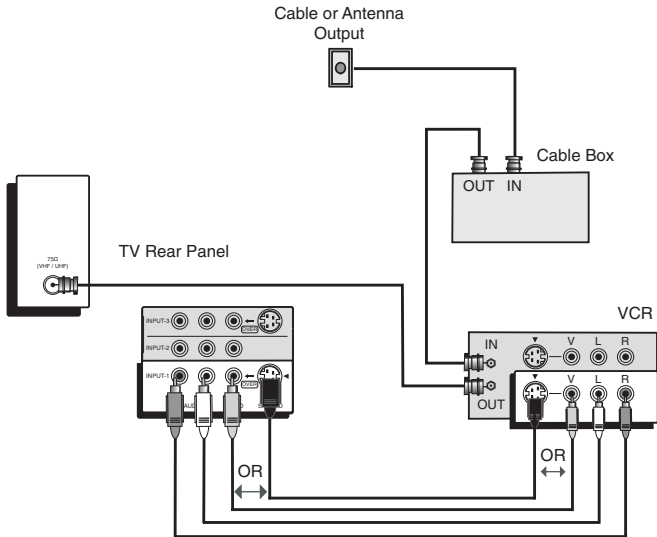

- 1) Connect an RF Cable from the wall outlet into the RF Cable Box In.
- 2) Connect an RF Cable from the Cable Box Out into the VCR In.
- 3) Connect an RF Cable from the VCR Out into the RF In on the back of the TV.
- 4) Connect the Red Cable from VCR Right Audio Output into the Red TV Audio In.
- 5) Connect the White Cable from VCR Left Audio Output into the White TV Audio In.
- 6) Connect the Yellow Cable from VCR Output into the Yellow TV Video In, OR Connect an S-Video Cable from VCR S-Video Out into the S-Video In on the back of the TV.

NOTE:

- White, Yellow and Red are the most common colors for VCR Cables. Some models may vary in color. Please consult the user's manual for your VCR Player for more information.
- See page 23 for instructions on programming your remote control to operate the basic functions of your VCR Player.

The connection diagrams are intended to show some basic general connections. Some cable companies may require special connections to properly use your television or 2-tuner MULTI SCREEN function. If you follow these diagrams and either the television or PIP does not work properly, contact your local cable operator for more connection information. Please see page 54 for more information on the POP feature.

Connections

Connecting a DVD Player, DTV Decoder, and D-VHS

Your AV-56WP30 or AV-48WP30 television is HDTV and SDTV-Ready. This means it can display High Definition television images when connected to a digital television receiver*. DTV Decoders are available separately. For best image quality, we recommend using a DTV Decoder which uses Component Video (Y, PB, PR) Output to connect to the television. The diagram below shows how to connect a DTV Decoder with using the television's Component Video-in jacks.

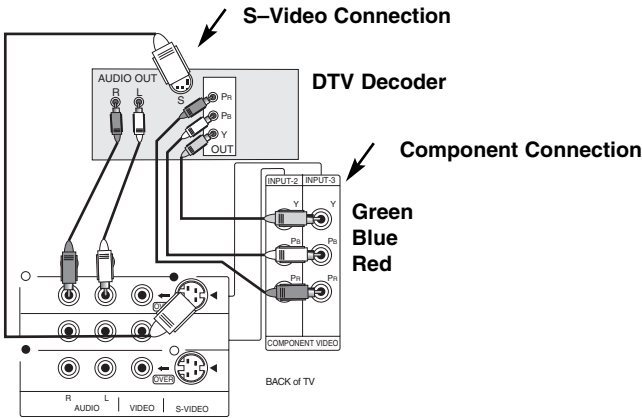

- 1) Connect Green cable out from the DTV Decoder “Y” Video Output, in to TV “Y” Component Input.
- 2) Connect Blue cable out from the DTV Decoder “PB” Video Output, in to TV “PB” Component Input.
- 3) Connect Red cable out from the DTV Decoder “PR” Video Output, in to TV “PR” Component Input.
- 4) Connect White Audio cable out the DTV Decoder Left Audio Output, in to TV Left Audio Input.
- 5) Connect Red Audio cable out the DTV Decoder Right Audio Output, in to TV Right Audio Input.

Make sure you use the same numbered input for both the Component Input and Audio Input. For instance, if you use Component Input 2, also use Audio Input 2.

- Green, blue and red are the most common colors for Component Video cables. Some models may vary colors, please consult the user's manual for your DTV Decoder for more information.
- Be careful not to confuse the red Component Video cable with the red audio cable. It is best to complete one set of connections (Audio or Video) before starting the other to avoid accidentally switching the cables.

* Notes About HDTV Operation

The AV-56WP30 or AV-48WP30 can display 480p, 480i, 1080i and 720p signal formats using the Component Video Inputs. It cannot display 1080p signal. For High Definition (HDTV) picture display a DTV decoder must be connected to the TV.

Connections

Connecting to a Digital TV Receiver w/HDCP

By inputting a high bandwidth Digital Content Protection High Definition picture source to the Digital-In terminal of this television, high-definition pictures can be displayed on the screen in their digital form. (This terminal is for use in the future when high bandwidth Digital Content Protection DTV decoders and DVD players and D-VHS are put on the market.)

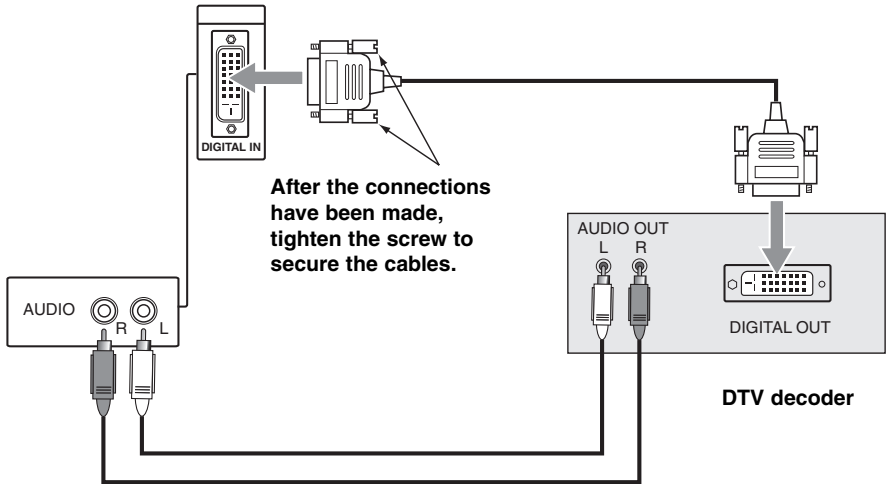

- 1) Connect the DTV digital RGB output terminal to the digital input terminal of the television, and then tighten the 2 screws.
 - 2) Connect the DTV decoder left audio output to the DIGITAL-IN left audio input.
 - 3) Connect the DTV decoder right audio output to the DIGITAL-IN right audio input.
- The Digital-In terminal can only be used with 1080i, 720p and 480p picture signals. Set the DTV decode Digital-Out terminal output setting to 1080i, 720p or 480p. For detailed information, refer to the DTV decoder instruction manual. If you can not display the picture because your DTV decoder does not have a Digital-Out terminal output setting, use the component Video Input (or the S-Video Input or Video Input). (Refer to page 15) In this case the picture will be displayed as an analog signal.
 - The Digital-In terminal is not compatible with the picture signal of a personal computer.
 - Use a DVI-D Single Link 19-pin cable (commercially available) in order to digitally connect the television with a DTV decoder.

If 480p signals (640x480 or 720x480) are displayed on the screen, the horizontal balance may be slightly shifted. In cases such as this, the horizontal balance can be adjusted by accessing "DIGITAL-IN" in the INITIAL SETUP Menu. (Refer to page 41.)

Connections

Connecting a DVD Player

You can use the Component Video input jacks to connect a DVD player to your television. To connect a DVD player, please follow the steps listed below.

- 1) Connect Green cable out from the DVD Player “Y” Video Output, in to TV “Y” Component Input.
- 2) Connect Blue cable out from the DVD Player “PB” Video Output, in to TV “PB” Component Input.
- 3) Connect Red cable out from the DVD Player “PR” Video Output, in to TV PR” Component Input.
- 4) Connect White Audio cable out the DVD Player Left Audio Output, in to TV Left Audio Input.
- 5) Connect Red Audio cable out the DVD Player Right Audio Output, in to TV Right Audio Input.

Make sure you use the same numbered input for both the Component Input and Audio Input. For instance, if you use Component Input 3, also use Audio Input 3.

- Green, blue and red are the most common colors for Component Video cables. Some models may vary colors, please consult the user’s manual for your DVD Player for more information.
- Be careful not to confuse the red Component Video cable with the red audio cable. It is best to complete one set of connections (Audio or Video) before starting the other to avoid accidentally switching the cables.
- If your DVD player does not have a Component Video output, you may connect it using an S-Video cable. See your DVD player’s owners manual for more information on making an S-Video connection.

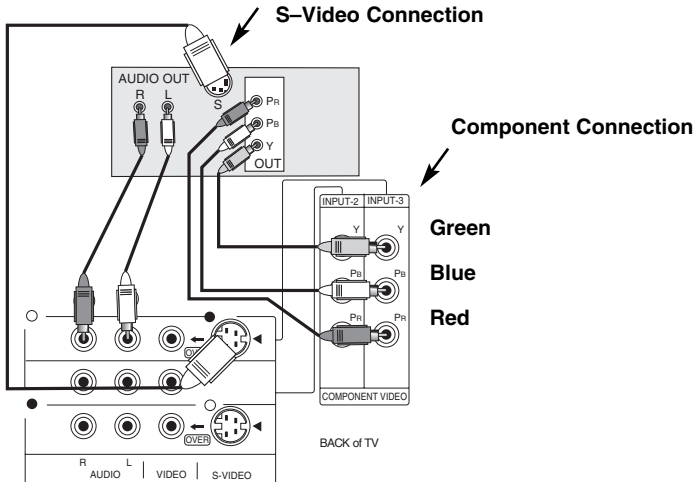

Note:

If you want to display the picture from the DVD player when using split screens, also connect the S-Video cable.

Connections

Connecting to AV Compu-Link III

JVC's AV Compu Link III feature makes playing video tapes totally automatic. Simply insert a pre-recorded tape* into your JVC-brand VCR and the VCR will automatically turn on and begin playback. At the same time, using the AV Compu Link, the VCR sends a signal to the television telling it to turn on and switch to the proper video input to watch a video tape.

- The AV Compu Link cable may be included with the JVC AV Compu Link accessory you wish to connect. If it is not, contact an authorized JVC Service Center for part # EWP 805-012.
- AV Compu Link III can only be used with JVC-brand products.

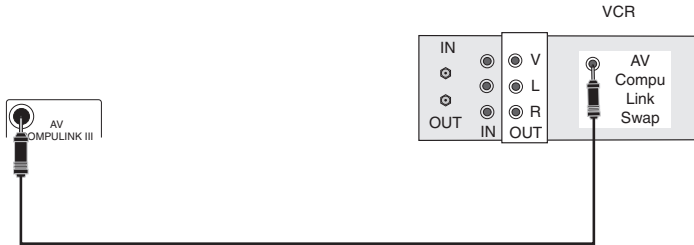

To Connect: Plug one end of the AV Compu Link cable into the AV Compu Link input on your VCR or other Compu Link device. Plug the other end of the AV Compu Link cable into the AV Compu Link input at the rear of the television.

Notes:

- * In order for the VCR playback to begin automatically, the recording tabs must be removed from the VHS tape. If the tab is in place, automatic switching will occur when you push the VCR's PLAY button.
- The AV Compu Link cable has a male 3.5 mm (mono) plug on each end.
- If your JVC-brand VCR has "A Code/B Code Remote Control Switching" (see your VCR's instruction book), using VCR A Code will switch the TV to input 1. If you use Input 1 for video input from your cable box, use VCR B Code to select the TV Video Input 2.
- To connect a JVC HiFi receiver or amplifier for a completely automated home theater, see the HiFi's connection instructions for detailed connection information.
- AV COMPU LINK III is compatible with all JVC AV COMPU LINK III devices
- The AV-56WP30 or AV-48WP30 can also receive Compu-Link signals from a DVD player. For details on operating a DVD player with AV Compu Link, please see your DVD player's owners manual.

Connecting Devices to the Front Panel Inputs

A set of inputs (Input-4) are provided for your convenience on the front panel of the AV-56WP30 or AV-48WP30. The inputs are located behind the door at the center of the front panel below the indicator lights. These inputs are designed for the easy connection of devices like camcorders or game consoles which are not permanent parts of your home entertainment center.

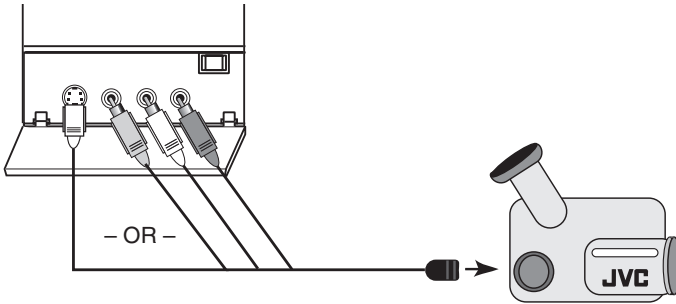

To access the front panel jacks, gently pull the tab on the door towards you to open it.

To connect a device like a camcorder:

- 1) Connect the yellow video cable from the device's Video Output jack to the TV's Video Input jack, or connect an S-Video cable from the camcorder's S-Video Output to the TV's S-Video Input.
 - 2) Connect the white (or black) audio cable from the device's Left Audio Output jack to the TV's Left Audio Input jack.
 - 3) Connect the red audio cable from the device's Right Audio Output jack to the TV's Right Audio Input jack.
- If you are connecting a mono sound device it will have only one audio out jack. Connect it to the TV's left audio input jack.
 - The device will be available on Input 4 on the Input Menu (see page 58) if the connection shown above is used.
 - Please consult your camcorder or other device's owners manual for more information on its operation.

Connections

Connecting to an External Amplifier

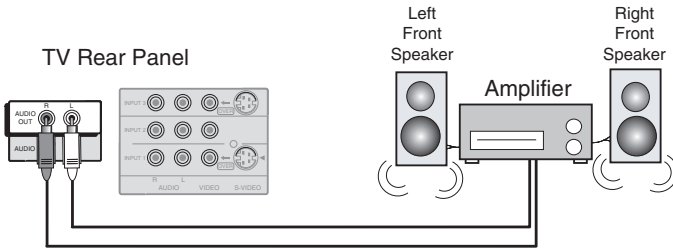

- 1) Connect the White Audio Cable from the TV's Left Audio Output Jack to the Amplifier's Left Audio Input Jack.
- 2) Connect the Red Audio Cable from the TV's Right Audio Output Jack to the Amplifier's Right Audio Input Jack.

Connecting to the Surround Amplifier

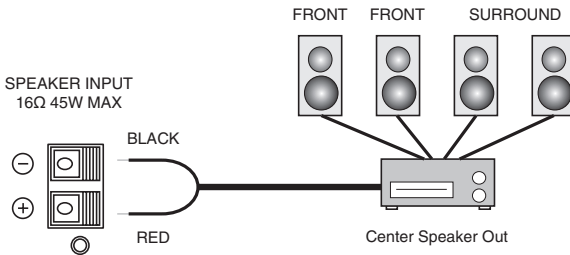

- 1) Connect the BLACK speaker cable from the TV's SPEAKER INPUT ⊖ terminal to the surround amplifier's center speaker output ⊖ terminal.
- 2) Connect the RED speaker cable from the TV's SPEAKER INPUT ⊕ terminal to the surround amplifier's center speaker output ⊕ terminal.

Remote Control

Install the Batteries

- Before you can operate the remote control, you must first install the batteries (included).
- Push down on the remote's back cover and slide towards the bottom to remove it.
- Insert two AA batteries (supplied), carefully noting the "+" and "-" markings on the batteries and on the remote control. To avoid a potential short circuit, insert the "-" end first. Be sure to use only size AA batteries.
- When batteries are installed, slide the cover back into place (until it clicks into position).
- If the remote control acts erratically, replace the batteries. Typical battery life is six months to one year. We recommend using alkaline batteries for longer battery life.
- When you change the batteries, try to complete the task within three minutes. If you take longer than three minutes, the remote control codes for your VCR, DVD, and/or Cable Box may have to be reset (pages 22-24).

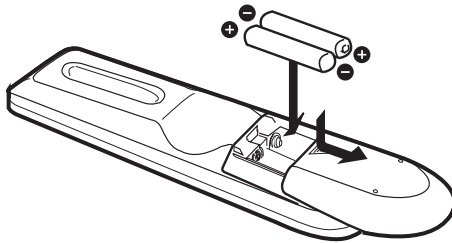

Remote Control Basics

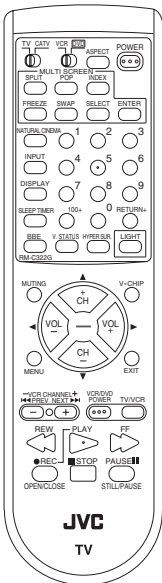

- Press the **POWER** button to turn the television on or off.
- **Make sure the TV/CATV switch** is set to TV. Move the switch to CATV only if you need to operate a cable box.
- **Slide the VCR/DVD selector switch** to VCR to control a VCR, slide to DVD to control a DVD player. Please see pages 22 to 24 for instructions on programming your remote control to operate a Cable box, VCR or DVD player.
- Press the **CH+** and **CH-** buttons to scan through the channels. Tap the **CH+** or **CH-** button to move through the channels one channel at a time.
- To move rapidly through the channels using JVC's **Hyper Scan** feature, press and hold **CH+** or **CH-**. The channels will zip by at a rate of five channels per second.
- Press **VOL+** or **VOL-** to raise or lower the volume. An indicator bar will appear onscreen to show you the television volume level.
- The **CH+/-** and **VOL+/-** buttons are also used to navigate JVC's onscreen menu system.
- You can directly access specific channels using the 10-key pad.
- For more information on remote control button features, see pages 53 to 59. For information on using the onscreen menus, see page 26.

Remote Programming

Setting the CATV, VCR and DVD Codes

You can program your remote to operate your cable box, satellite receiver, VCR or DVD player by using the instructions and codes listed below. If the equipment does not respond to any of the codes listed below or to the code search function, use the remote control supplied by the manufacturer.

Cable Box or Satellite Setup

The remote control is programmed with CATV and/or Satellite codes for power on, power off, channel up, channel down, and 10 key operation.

- 1) Find the CATV/Satellite brand from the list of codes shown below.
 - 2) Slide the 2-way selector switch to "CATV".
 - 3) Press and hold down the DISPLAY button.
 - 4) With the DISPLAY button held down, enter the first code number listed using the 10 key pad.
 - 5) Release the DISPLAY button.
 - 6) Confirm the operation of the Cable Box/Satellite receiver.
- If your CATV or Satellite box does not respond to the first code, try the others listed. If it does not respond to any code, try the Search Codes Function, on page 25.

Cable Box	CODES	Cable Box	CODES	Digital Satellite Systems	CODES
ABC	024	Puser	032		
Archer	032, 025	RCA	061, 070	EchoStar	100, 113, 114
Cableview	051, 032	Realistic	032	Express VU	100, 113
Citizen	022, 051	Regal	058, 064, 040, 041, 042, 045, 068	G.E.	106
Curtis	058, 059	Regency	034	G.I.	108
Diamond	024, 032, 025	Rembrandt	037, 032, 051, 038	Gradiente	112
Eagle	029	Samsung	051	Hitachi	104, 111
Eastern	034	Scientific Atlanta	057, 058, 059	HNS (Hughes)	104
GC Brand	032, 051	SMark	051, 047	Panasonic	105
Gemini	022, 043	Sprucer	051, 056	Philips	102, 103
General Instrument	065, 024, 025, 026, 027, 020, 021, 022, 057, 023	Stargate	032, 051	Primestar	108
Hamlin	040, 041, 042, 045, 058, 064	Telecaption	067	Proscan	106, 109, 110
Hitachi	049, 024	Televue	047, 051	RCA	106, 109, 110
Jerrold	065, 024, 025, 026, 027, 020, 021, 022, 057, 023	Texscan	044	Sony	107
		Tocom	035, 036, 066	Star Choice	104, 108
		Toshiba	050	Toshiba	101
Macom	049, 050, 051, 054	Unika	032, 025	Uniden	102, 103
Magnavox	033	Universal	022, 032		
Memorex	030	Videoway	052		
Movietime	032, 051	Viewstar	029, 030		
Oak	039, 037, 048	Zenith	063, 046		
Panasonic	055, 056, 060, 071	Zenith/Drake Satellite	046		
Paragon	063				
Philips	028, 029, 030, 052, 053, 031, 069				
Pioneer	047, 062				
Pulsar	051, 032				

Remote Programming

VCR setup

The remote control is programmed with VCR codes for power on, power off, play, stop, fast-forward, rewind, pause, record, channel up, and channel down operation.

- 1) Find the VCR brand from the list of codes shown below.
 - 2) Slide the first 2-way selector switch to "TV" and the other 2-way selector switch to "VCR".
 - 3) Press and hold down the DISPLAY button.
 - 4) With the DISPLAY button held down, enter the first code number listed with the 10 key pad.
 - 5) Release the DISPLAY button.
 - 6) Confirm the operation of the VCR.
- If your VCR does not respond to the first code, try the others listed. If it does not respond to any code, try the Search Codes Function, on page 25.
 - Some manufacturer's VCR's may not respond to the Tv/VCR button, even if other buttons work properly.
 - To record, hold down the REC button on the remote and press PLAY.

VCRs	CODES	VCRs	CODES	VCRs	CODES
Admiral	035	Marantz	003, 004, 005	Samsung	037, 060, 062, 033, 089
Aiwa	027, 032, 095	Marta	064	Samtron	089
Akai	029, 072, 073, 074	Memorex	024, 067	Sansui	003, 026, 020, 052
Audio Dynamic	003, 005	MGA	038, 040, 047, 048, 041, 042	Sanyo	063, 067, 091, 071
Bell & Howell	063, 071	Minolta	058, 045, 093	Scott	059, 060, 062, 067, 038, 040, 047, 048, 026, 020
Broksonic	020, 026, 094	Mitsubishi	038, 040, 047, 048, 041, 042, 078, 090	Sears	063, 064, 065, 066, 058, 000, 001
Canon	023, 025	Multitech	047, 027, 062	Shintom	075
CCE	043	NEC	003, 004, 005, 000	Sharp	035, 036, 080, 088
Citizen	064	Olympic	024, 023	Signature 2000	027, 035
Craig	063, 029, 064	Optimus	028, 021, 035, 064	Singer	075
Curtis Mathes	045, 024, 027, 093	Orion	026, 020	Sony	028, 029, 030, 053, 054, 055
Daewoo	043, 059, 024, 092	Panasonic	023, 024, 021, 022	SV 2000	027
DBX	003, 004, 005	Penney	024, 058, 045, 063, 003, 004, 005, 093	Sylvania	031, 023, 024, 027
Dimensia	045, 093	Pentax	058, 005, 045, 093	Symphonic	027, 081
Emerson	043, 026, 077, 061, 025, 042, 020, 076	Philco	031, 024, 027, 023, 026, 020, 043	Tashiro	064
Fisher	063, 066, 067, 065, 071, 091	Philips	031, 023, 024, 086	Tatung	003, 004, 005
Funai	027, 026, 020, 000	Pioneer	023	Teac	003, 004, 027, 005
G. E.	033, 045, 024	Proscan	045, 058, 023, 024, 031, 046, 059, 060, 033, 087, 093	Technics	021, 022, 023, 024
Go Video	037, 051, 049, 050, 089	Quasar	021, 022, 023, 024	Teknika	024, 027, 070
Goldstar	064	Radio Shack	033, 024, 063, 036, 067, 040, 027	Toshiba	059, 046, 079
Gradiente	083, 084, 081, 000, 001	RCA	033, 045, 058, 023, 024, 031, 046, 059, 060, 083, 084, 085, 087, 093	Vector Research	005
Hitachi	023, 045, 058, 027, 081, 093	Realistic	024, 063, 036, 067, 040, 027	Wards	035, 036, 067, 044, 064
Instant Replay	024, 023			Yamaha	063, 003, 004, 005
Jensen	003			Zenith	044, 082, 064, 094
JVC	000, 001, 002, 003, 004, 005				
Kenwood	003, 004, 064, 005				
LXI	027, 064, 058, 065, 066, 063, 067				
Magnavox	031, 023, 024, 086				

Remote Programming

DVD Setup

The remote control is programmed with DVD codes for power on, power off, play, stop, fast-forward, rewind, previous chapter, next chapter, tray open/close, and still/pause operation.

- 1) Find the DVD player brand from the list of codes shown below.
 - 2) Slide the first 2-way selector switch to “TV” and the other 2-way selector switch to “DVD”.
 - 3) Press and hold down the DISPLAY button.
 - 4) With the DISPLAY button held down, enter the first code number listed with the 10 key pad.
 - 5) Release the DISPLAY button.
 - 6) Confirm the operation of the DVD player.
- If your DVD player does not respond to the first code, try the others listed. If it does not respond to any code, try the Search Codes Function, on page 25.
 - After you program your remote, some DVD buttons may not work properly. If some buttons do not work properly, use the remote control which came with your DVD player.

DVD Player	CODES	DVD Player	CODES
Aiwa	043	Raite	033
Apex	040	RCA	021, 026
Denon	020, 037	Sampo	034
Hitachi	030, 031	Samsung	030
JVC	000	Sharp	028
Kenwood	035	Sylvania	038
Konka	039	Sony	024, 045, 046, 047
Mitsubishi	025		
Onkyo	041	Technics	020
Oritron	044	Toshiba	023
Panasonic	020	Wave	042
Philips	023, 036	Yamaha	020
Pioneer	022	Zenith	027, 032

Remote Programming

Search Codes

Cable/Satellite Search Codes Function:

- 1) Slide the 2-Way Mode Selector switch to CATV.
- 2) Press the TV POWER and RETURN+ buttons. Hold for at least three seconds and release.
- 3) Press TV POWER, see if the CATV or Satellite box responds.
- 4) If there was a response, press RETURN+. The operating codes are now set. If there was no response, repeat Step 3. If you repeat Step 3 a total of 52 times without a response, use the remote control which came with the equipment.
- 5) Press RETURN+ to exit.

VCR Search Codes Function:

- 1) Slide the first 2-way selector switch to "TV" and the other 2-way selector switch to "VCR".
- 2) Press the VCR POWER and RETURN+ buttons. Hold for at least three seconds and release.
- 3) Press VCR POWER, see if the VCR responds.
- 4) If there was a response, press RETURN+. The operating codes are now set. If there was no response, repeat Step 3. If you repeat Step 3 a total of 80 times without a response, use the manufacturers remote control which came with the VCR.
- 5) Press RETURN+ to exit.

DVD Player Search Codes Function:

- 1) Slide the first 2-way selector switch to "TV" and the other 2-way selector switch to "DVD".
- 2) Press the DVD POWER and RETURN+ buttons. Hold for at least three seconds and release.
- 3) Press DVD POWER, see if the DVD player responds.
- 4) If there was a response, press RETURN+. The operating codes are now set. If there was no response, repeat Step 3. If you repeat Step 3 a total of 30 times without a response, use the manufacturers remote control which came with the DVD player.
- 5) Press RETURN+ to exit.

Onscreen Menus

The Onscreen Menu System

The AV-56WP30 or AV-48WP30 comes with JVC's Onscreen Menu System. The Onscreen Menus let you make adjustments to your television's operation simply and quickly. Examples of the Onscreen Menus are shown below and on the next page. Detailed explanations on using each menu follow later in this guide.

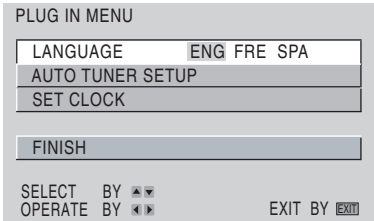

PLUG IN MENU

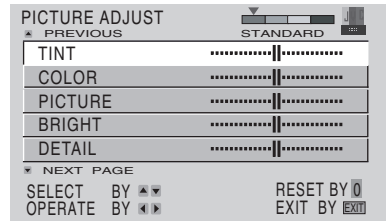

PICTURE ADJUST 1

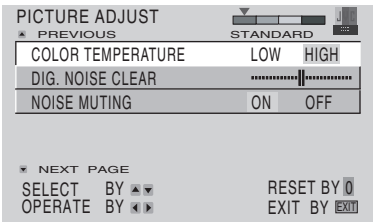

PICTURE ADJUST 2

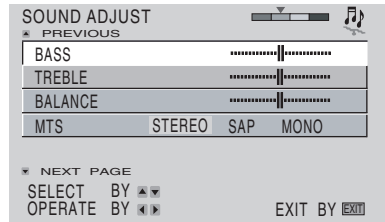

SOUND ADJUST

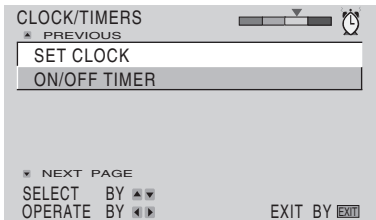

CLOCK/TIMERS

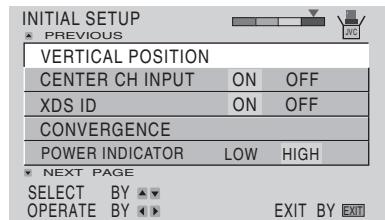

INITIAL SETUP 1

Onscreen Menus

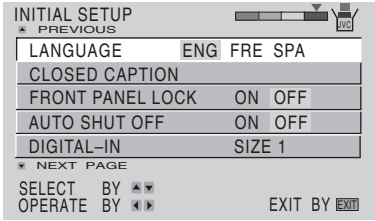

INITIAL SETUP 2

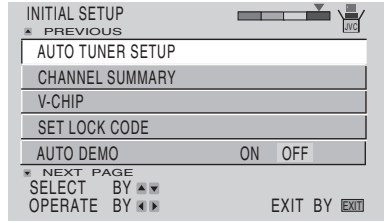

INITIAL SETUP 3

Note: The DIGITAL-IN menu can only be displayed when a 480p picture signal is input to the Digital-In terminal and the picture is being displayed on the screen.

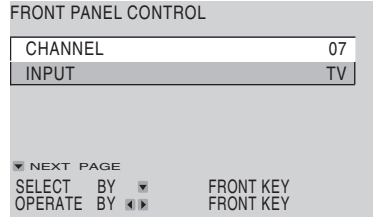

FRONT PANEL CONTROL

(Will appear only when MENU button on TV Front Panel is pressed.)

Using the Onscreen Menus

To open the Onscreen Menu system, press the MENU button on the remote control. You navigate within the Onscreen menus by using the four directional arrow buttons on the remote control. (These buttons are also the CH +/- and VOL +/- buttons - Channel and Volume functions will not operate when the Onscreen Menu is active).

The selected feature and option on a menu screen are highlighted in a different color.

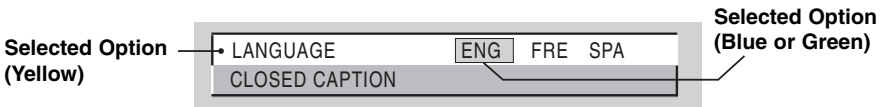

To move to a different feature use the ▲ ▼ arrows to move up or down the list. When you press the up arrow at the top of the list or the down arrow at the bottom, the next menu screen will appear. Use the arrows ◀ ▶ to select an option from the highlighted feature. Pressing EXIT on the remote control will close the Onscreen Menu system and return you to normal television viewing.

Each menu and its features will be discussed in the following pages of this guide.

Notes: You may also move to the next menu screen by pressing MENU again.

- If you do not press any buttons for a few seconds, the Onscreen menu will automatically shut off.
- Button names in this guide are shown in SMALL CAPITAL LETTERS.
- Menus may appear in different sizes onscreen depending on the aspect ratio selected.
- Some menu items may not appear in menu screens when certain aspect ratios or inputs are selected.

Plug In Menu

Plug In Menu

The first time you turn on your television, you will see the PLUG IN MENU. This menu is designed to help you get your television ready to watch right away. This menu includes some of the most important settings for the operation of your television, including onscreen display language, AUTO TUNER SETUP and setting the internal clock. It is important these preferences be set before you begin to use your new television. Detailed descriptions of each setting will follow.

- You may change these settings at any time by using the onscreen menu system.

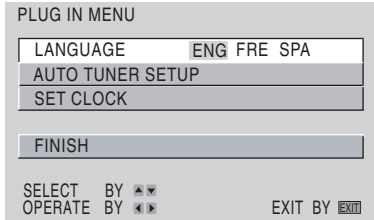

PLUG IN MENU

Use the up and down arrows ▼▲ to scroll to the first menu item. Use the ◀▶ arrows to move to select the item. You can make adjustments to any or all of the settings.

LANGUAGE ENG FRE SPA

You can view the onscreen menu displays in one of three languages - English, French, or Spanish. When shipped from the factory, all menus will display in English. You can use the language setting to change the menus to one of the other two languages if you wish.

To change the language, use the ▼▲ arrows to move to LANGUAGE. With the Language option selected, use the ◀▶ arrows to move to the language you wish to select, English, French or Spanish. As you highlight a language, the menu will display in that language. Your selection will be entered when you move to a different option using the ▼▲ arrows or press EXIT to leave the menu system.

AUTO TUNER SETUP

The AUTO TUNER SETUP feature automatically scans through all the channels your television can receive and memorizes only the channels with clear, active signals. This means when you scan through the channels, you will receive only channels with good signals, no more annoying static or dead air.



Press the MENU button



To AUTO TUNER SETUP



To operate



To choose CABLE or AIR



To move to START



To start Auto Tuner Setup

NOW
PROGRAMMING !



48

The television will now scan through all the channels it can receive, memorizing those with clear, active signals. Programming will take several minutes. When it is finished the following message will appear:

PROGRAMMING OVER!

You may add or delete channels from the Auto Tuner scan. If there are channels you do not wish to receive or if the Auto Tuner missed a channel which may have not been broadcasting or had a weak signal, you can modify the scan using the CHANNEL SUMMARY feature. For information on CHANNEL SUMMARY, see page 32.

Plug In Menu

SET CLOCK

The AV-56WP30 or AV-48WP30 is equipped with its own internal clock. The clock is used to run the television's timer features. The clock **MUST** be set before you can use any of the timer features. Your television features the XDS AUTO CLOCK set feature which makes setting the correct time simple.

To set the clock, use the arrows to move to SET CLOCK on the PLUG IN MENU. Select the option by pressing ◀ or ▶.

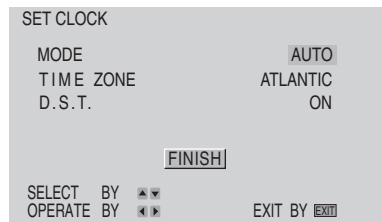

SET CLOCK (AUTO)

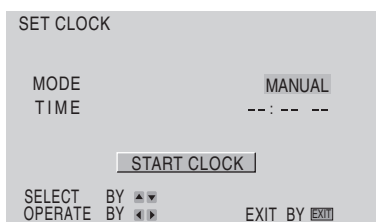

SET CLOCK (MANUAL)

The SET CLOCK menu will now appear. If you have a Public Television System station broadcasting in your local area you can select the AUTO option (PBS stations carry the XDS time signal). The television will automatically collect the time information. The only information you will need to provide is what time zone you are located in and if Daylight Savings Time is currently in effect.

Once the AUTO mode has been selected, use the ▼ arrow to move to TIME ZONE. Select the time zone using the ◀ or ▶ arrows. Once your time zone is set, use the ▼ arrow to move to D.S.T. Select D.S.T., by pressing ◀ or ▶. Choose ON or OFF with the ◀ or ▶ arrows. Now use the ▼ arrow to move to FINISH. Finish by pressing ◀ or ▶.

If you do not have a PBS station in your local area, or if the AUTO option does not give you the correct time for your area, you will have to set the time manually. Select the MANUAL option. To set the clock manually, use the ▼ arrow to move to the Time. Use the ◀ or ▶ arrows to set the hours. Press the ▼ arrow to move to minutes. Set the minutes with the ◀ or ▶ arrows. When the correct time is set, use the ▼ arrow to move to START CLOCK. Press ◀ or ▶ to start the clock and exit.

Special Note for residents of Newfoundland in Canada.

The Newfoundland time zone is not included in the time zones listed in AUTO CLOCK SETUP. If you live in the Newfoundland time zone, you must set your clock using the manual clock set option.

FINISH

Once you have completed setting the options in the PLUG IN MENU, choose FINISH to leave the menu and begin watching your television. Use the arrows to move to FINISH at the bottom of the PLUG IN MENU. Select FINISH by pressing ◀ or ▶. Your PLUG IN MENU settings are now complete. You may now begin watching your television. If you wish to further customize your television to your viewing preferences, please continue reading.

Note: You can change your PLUG IN MENU settings at any time. You can access LANGUAGE, AUTO TUNER SETUP and SET CLOCK from the onscreen menu system.

INITIAL SETUP Menu

While the PLUG IN MENU will help you get your television ready to watch right away, the INITIAL SETUP menu gives you access to many built-in functions to help you customize your television to meet your personal viewing tastes. This manual will describe how each function works in the order they appear in the onscreen menu system. Some of these items will also appear in the PLUG IN MENU. If you wish to change the settings of these menu items from the settings you entered while using the PLUG IN MENU, you may do so from the INITIAL SETUP menus.

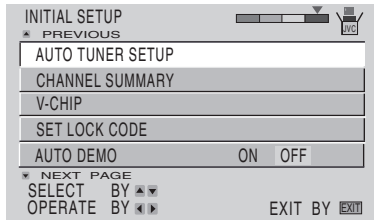

INITIAL SETUP MENU

AUTO TUNER SETUP

The AUTO TUNER SETUP function is described on page 29. If you need to run AUTO TUNER SETUP again, select the option from the INITIAL SETUP menu by using the ▲▼ arrows to move to the AUTO TUNER SETUP option in the INITIAL SETUP menu. Select the option by pressing ◀ or ▶. Please see page 29 for instructions on running the AUTO TUNER SETUP feature.

AUTO DEMO

ON OFF

This function lets you preview the many different viewing modes of your TV. It will cycle through "INDEX", "POP", "SPLIT DEMO", "FREEZE DEMO", all of the different "ASPECT" ratios and all of the different "VIDEO STATUS" modes.



Press the MENU button



to AUTO DEMO



to adjust AUTO DEMO on or off.

Note: To stop AUTO DEMO, press the EXIT button two times. This will allow you to pause the AUTO DEMO function, and turn it off in the setup menu. You may need to press the VIDEO STATUS button, to return to your previous video setting.

Initial Setup

CHANNEL SUMMARY

CHANNEL SUMMARY lets you customize the list of channels set after you run AUTO TUNER SETUP. You may delete unwanted channels or add channels that are new, or were not picked up by AUTO TUNER SETUP because of weak signals.

To access the CHANNEL SUMMARY, use the ▲▼ arrows to move to the CHANNEL SUMMARY option in the INITIAL SETUP menu. Select the option by pressing ◀ or ▶.

The CHANNEL SUMMARY screen will now be displayed with the channels set to scan marked with an “✓”. You can delete channels from the scan by removing the “✓”. If any channels were missed during AUTO TUNER SETUP and you wish to add them, you may be placing an “✓” next to the channel number.

CHNO.	SCAN	LOCK	CHNO.	SCAN	LOCK
01		🔒	06	✓	
02	✓		07		
03	✓		08		
04	✓		09	✓	
05	✓		10	✓	

To add or delete channels, use the ▲▼ arrows to move to the SCAN column. Use the ▲▼ arrows to move through the list of channels. Press ◀ or ▶ to include or delete channels from scanning. When you have added or deleted all the channels you wish, you can leave the CHANNEL SUMMARY screen by pressing EXIT on the remote control.

CHANNEL SUMMARY - LOCK

You can also use the CHANNEL SUMMARY screen to lock certain channels. When a channel is locked, a code must be entered before the channel can be viewed.

CHNO.	SCAN	LOCK	CHNO.	SCAN	LOCK
01	✓	🔒	06	✓	🔒
02	✓		07		🔒
03	✓		08		🔒
04	✓		09	✓	
05	✓		10	✓	

To lock or unlock channels, use the ▲▼ arrows to move to the Lock column (marked with the 🔒 icon). Use the ▲▼ arrows to move through the list of channels. Press the ZERO button on the remote control to lock or unlock a specific channel. A channel is locked when the 🔒 icon appears next to it. When you are finished, you can leave the CHANNEL SUMMARY screen by pressing EXIT on the remote control.

CHANNEL GUARD MESSAGE

When a viewer attempts to watch a guarded channel, this message appears:

To watch a channel that you have locked, enter the Lock Code using the 10 key pad (see “Set Lock Code” - page 38). If the wrong code is entered, the message INVALID LOCK CODE! will flash on the screen. The channel cannot be accessed until the correct code is entered.

- Once a channel has been unlocked, it will remain unlocked until the television is turned off.

THIS CHANNEL IS LOCKED BY
CHANNEL GUARD.
PLEASE ENTER LOCK CODE BY
10 KEY PAD TO UNLOCK IT.

NO. - - - -

V-Chip

Your TV is equipped with V-Chip technology which enables TV Parental Guideline and Movie (MPAA) Guideline controls. V-Chip technology allows you to program your TV to receive, or not to receive, programs based on content according to the guidelines. Programs which exceed the ratings limits you set will be blocked from viewing.

U.S. Parental Rating Systems

Programs with the following Ratings are appropriate for Children.

TV-Y is Appropriate for All Children. Programs are created for very young viewers and should be suitable for all ages, including children ages 2 - 6.

TV-Y7 is for Older Children. Most parents would find such programs suitable for children 7 and above. They may contain some mild fantasy violence or comedic violence, which children should be able to discern from reality.

Programs with the following Ratings are designed for the entire audience.

TV-G stands for General Audience. Most parents would find these programs suitable for all age groups. They contain little or no violence, no strong language, and little or no sexual dialog or situations.

TV-PG Parental Guidance Suggested. May contain some, but not much, strong language, limited violence, and some suggestive sexual dialog or situations. It is recommended that parents watch these programs first, or with their children.

TV-14 Parents Strongly Cautioned. Programs contain some material that may be unsuitable for children under the age of 14 including possible intense violence, sexual situations, strong coarse language, or intensely suggestive dialog. Parents are cautioned against unattended viewing by children under 14.

TV-MA Mature Audiences Only. These programs are specifically for adults and may be unsuitable for anyone under 17 years of age. TV-MA programs may have extensive V, S, L, or D.

Viewing Guidelines

In addition to general ratings, programs may include specific information on content. The following codes are used:

- V/FV is for VIOLENCE/FANTASY VIOLENCE
- S stands for SEXUAL CONTENT
- L stands for strong LANGUAGE
- D stands for suggestive DIALOG

V-Chip

MPAA (Motion Picture Assoc. of America) Ratings

NR - Not Rated.

This is a film which has no rating. In many cases these films were imported from countries which do not use the MPAA ratings system. Other NR films may be from amateur producers who didn't intend to have their film widely released.

"NR" Programming may contain all types of programming including children's programming, foreign programs, or adult material.

G - General Audience. In the opinion of the review board, these films contain nothing in the way of sexual content, violence, or language that would be unsuitable for audiences of any age.

PG - Parental Guidance. Parental Guidance means the movie may contain some contents such as mild violence, some brief nudity, and strong language. The contents are not deemed intense.

PG-13 - Parents Strongly Cautioned. Parents with children under 13 are cautioned that the content of movies with this rating may include more explicit sexual, language, and violence content than movies rated PG.

R - Restricted. These films contain material that is explicit in nature and is not recommended for unsupervised children under the age of 17.

NC-17 - No One Under 17. These movies contain content which most parents would feel is too adult for their children to view. Content can consist of strong language, nudity, violence, and suggestive or explicit subject matter.

X - No One under 18. Inappropriate material for anyone under 18.

Special Note about Ratings

Some programs are broadcast without a ratings signal. Therefore, even if you setup V-CHIP ratings limits, these programs will not be blocked. Parents are cautioned to preview the contents of these programs or movies.

Note (for Canadian viewers): The V-CHIP function is based on specifications designed for the United States and therefore may not work properly in Canada.

Set Ratings Guidelines

You can set your V-Chip to automatically block programming above a certain level using either the television or motion picture ratings systems, or both. If a program contains a rating above the levels you set, it will automatically be blocked from viewing unless the four-digit lock code is entered.



Press the MENU button



To V-CHIP



To operate (Lock icon  will appear)



Press ZERO to access the V-Chip menu



To turn V-Chip ON or OFF (V-Chip must be turned ON for rating settings to operate)



To move to SET US TV RATINGS, SET MOVIE RATINGS, or SET CANADIAN RATINGS, (see following pages for descriptions of each item)

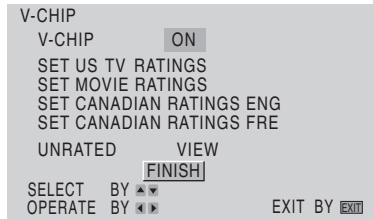

V-CHIP Settings Menu

To Set TV Ratings Levels

Use the **▲▼** arrows to move to SET US TV RATINGS. Select this option by pressing **◀** or **▶**. The screen on the right will appear. Use the **▲▼** arrows to move up and down the columns. Press **◀** or **▶** to turn the locking feature on or off. You may block an entire rating category like TV-14, or you may block individual items, like TV-14 shows with V (violence).

To block an entire category, move the cursor to the top of a column, for example TV-14. Press **◀** or **▶**. Lock icons will appear down the entire TV-14 column. All programs with a rating of TV-14 will be blocked.

To block an individual item, use the **▲▼** arrows to move to the mark for the item you wish to block, for example TV-14 with Violence. Press **◀** or **▶**. The lock icon will appear in the TV-14 V space. All programs with a TV-14 V rating will be blocked.

When you have finished setting your rating limits, press **▼** to move to FINISH. Press **◀** or **▶** to save your settings and exit.

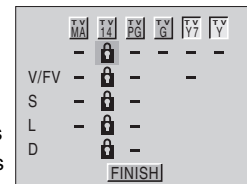
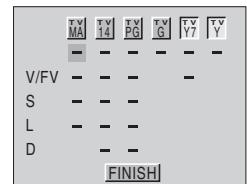

V-Chip

To Set Movie (MPAA) Ratings Levels

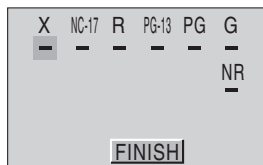

Use the ▲▼ arrows to move to SET MOVIE RATINGS. Select this option by pressing ◀ or ▶. The screen on the left will appear. Use the ▲▼ arrows to move to a movie rating, such as X. Press ◀ or ▶ to turn the ratings block on or off.

When you have set your movie ratings levels, press ▼ to move to FINISH. Press ◀ or ▶ to save your settings and exit.

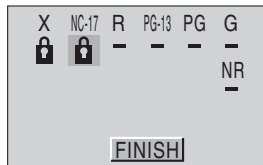

Unrated Programs

You have the choice of allowing programs without a rating signal to be shown or to have unrated programs blocked. To set this option, use the ▲▼ arrows to move to UNRATED in the V-CHIP menu. Use the ◀ or ▶ arrows to select VIEW to show unrated programs, or BLOCK to keep them from being shown. When you have made your selection, press EXIT to return to normal television viewing.

Unrated programming refers to any programming which does not contain a rating signal. Programming on television stations which do not broadcast rating signals will be placed in the "Unrated Programming" category.

Examples of Unrated programs:

Emergency Bulletins	Sports
Locally Originated Programming	Weather
News	Some Commercials
Political Programs	
Public Service Announcements	
Religious Programs	

- TV programs or movies that do not have rating signals will be blocked if the Unrated Category is set to LOCK.

Warning Message

When a viewer attempts to watch a program which exceeds the set ratings limits, the following warning message will appear:

THIS PROGRAMMING EXCEEDS
YOUR RATINGS LIMITS.
PLEASE ENTER LOCK CODE BY
10 KEY PAD TO UNLOCK IT.
NO. - - - -

To watch a blocked program, enter the four-digit access code to unlock that channel. Once the correct code is entered, the channel will be unlocked and the program shown.

If an incorrect code is entered the message INVALID LOCK CODE! will flash onscreen. The channel will remain locked until the correct code is entered.

Canadian V-Chip Ratings

❑ **E - Exempt.**

Exempt programming includes: news, sports, documentaries and other information programming, talk shows, music videos, and variety programming.

❑ **C – Programming Intended for Children.**

Violence Guidelines: There will be no realistic scenes of violence. Depictions of aggressive behavior will be infrequent and limited to portrayals that are clearly imaginary, comedic or unrealistic in nature.

❑ **C8+ – Programming Intended for Children 8 and Over.**

Violence Guidelines: Any realistic depictions of violence will be infrequent, discreet, of low intensity and will show the consequences of the acts. There will be no offensive language, nudity or sexual content.

❑ **G – General Audience.**

Programming will contain little violence and will be sensitive to themes which could affect younger children.

❑ **PG - Parental Guidance.**

Programming intended for a general audience, but which may not be suitable for younger children. Parents may consider some content not appropriate for children aged 8-13.

❑ **14+ - 14 Years and Older.**

Parents are strongly cautioned to exercise discretion in permitting viewing by pre-teens and early teens. Programming may contain mature themes and scenes of intense violence.

❑ **18+ - Adult.**

Material intended for mature audiences only.

Directions to set Canadian V-Chip Ratings:



Press the MENU button



To V-CHIP



To operate (Lock icon  appears)



Press ZERO to access V-Chip setup options



To SET CANADIAN RATINGS ENG (for English)



To enter ratings menu

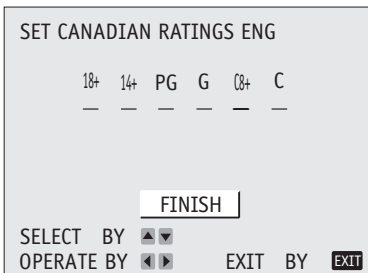

For example,

to block viewing of programming rated 14+ and 18+ :

▲▼ To the 18+ Column

◀▶ To turn on the lock

▲▼ To the 14+ Column

◀▶ To turn on the lock

▲▼ To FINISH

◀▶ To save settings and exit

- For instructions on “Set Canadian Ratings FRE (in French)”, please see page 37 in the French side of this user’s guide.

V-Chip

Set Lock Code

Channel Guard and V-Chip settings are protected by a four-digit Lock Code. Your TV comes pre-set with a Lock Code of "0000". You may change the code to any four-digit number you wish. To change the Lock Code, follow the steps below.

Access the onscreen menus by pressing MENU on your remote control. You may then either use the up and down arrows ▲ ▼ to scroll to the INITIAL SETUP menu, or press MENU until the INITIAL SETUP screen appears. Use the ▲ ▼ arrows to move to the Set Lock Code. Press the ◀ or ▶ arrows to select.

The Padlock icon  will appear. Press Zero on the remote's 10-key pad to access the LOCK CODE.

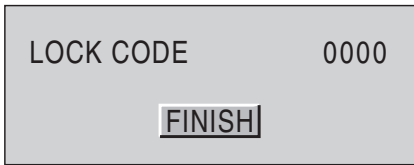

Use the ◀ or ▶ arrow to change the first digit. When you have selected the first number, move to the second digit by pressing the ▼ arrow. You can change this digit using the ◀ ▶ arrows. Repeat this process until all four digits are set. When you have entered your LOCK CODE, press ▼ to move to FINISH.

Press ◀ or ▶ to exit.

Notes: In order for V-Chip settings to take effect, **V-Chip settings must be turned ON in the V-CHIP menu (page 35)**. You can automatically unblock all of your restrictions by turning V-Chip settings OFF in the V-CHIP menu (page 35). You can always unblock a restriction by re-entering the V-CHIP menu and removing the lock icon.

Initial Setup 2

This menu lets you set up some of the functions of the television to meet your personal tastes and needs. You may select one of three languages for onscreen displays, turn closed captioning ON or OFF, adjust an image's vertical position, automatically enhance the picture quality of certain broadcasts, or adjust the size of the 480p picture signal which is input from the Digital-In terminal.

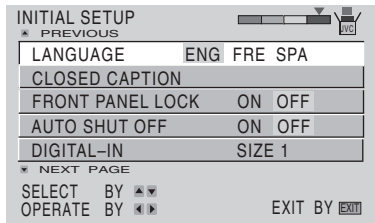

INITIAL SETUP Menu

Access the onscreen menus by pressing MENU on your remote control. You may then either use the up and down arrows ▲ ▼ to scroll to the INITIAL SETUP menu, or press MENU until the INITIAL SETUP screen appears. Use the ◀ or ▶ arrows to move to the setting you wish to change. You can make adjustments to any or all of the settings.

LANGUAGE ENG FRE SPA

You can view the onscreen menu displays in one of three languages - English, French, or Spanish. (See page 28).

CLOSED CAPTION

Many programs now include additional CLOSED CAPTION information as part of their broadcast. CLOSED CAPTIONS often are a text summary of onscreen dialog. Closed Captioning can also include additional information about a program's subject, presented in text form. Your television can be set to display closed captions if you wish.

To display CLOSED CAPTIONS, use the ▲ ▼ arrows to move to CLOSED CAPTION. Select the option by pressing the ◀ or ▶ arrows.

Continued at top of next page.

Initial Setup

CLOSED CAPTION - CONTINUED

A new CLOSED CAPTION menu will now appear. The **MODE OPTION** will be highlighted. This lets you set the operating mode for the CLOSED CAPTION feature. You can set it to: **CLOSED CAPTION** - to display onscreen dialog in a text format, **TEXT** - to display additional information included in a broadcast, or **OFF** - to turn the captioning feature off.

If you select CAPTION or TEXT, the next step is to choose a CLOSED CAPTION channel. Your television can receive four channels of CAPTION information and four channels of TEXT, though only one will be displayed at a time. Using the ▼ arrow, move to either CAPTION or TEXT, depending on the selection you made in MODE. Select the channel you wish to use.

Once your Caption preferences are set use the ▼ arrow to move to FINISH. Press ◀ or ▶ to save your settings and exit the menu.

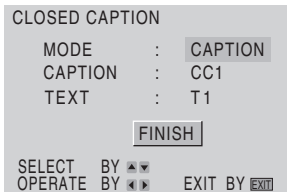

CLOSED CAPTION Menu

Note: Most CAPTION information can be found on CC1, most TEXT can be found on T1. The others are available for future use

Note: CLOSED CAPTION subtitles are programmed by the broadcast channel. Any misspellings are the fault of the broadcaster and not a malfunction of the television. Closed Captioning may not work correctly if the signal being received is weak or if you are playing a video tape. Not every broadcast will include a Closed Caption signal. Most programs containing CLOSED CAPTION information will display a notice at the start of the broadcast. 1080i signals are available only when using a Digital TV decoder (see page 15 for DTV decoder connections).

FRONT PANEL LOCK ON OFF

This locks the front panel of the TV so that a child may not accidentally mess up your settings



Press the MENU button



To FRONT PANEL LOCK



To adjust FRONT PANEL LOCK on or off.

Note: If you unplug the power cord from the wall, or press the Menu button on the front panel for more than three seconds, you can turn the FRONT PANEL LOCK function off without using the remote control.

AUTO SHUT OFF ON OFF

This feature allows you to tell the TV how long to stay on before shutting off. This is useful if you fall asleep and forget to turn the TV off. When there is no signal for one minute, the message "NOT RECEIVING A SIGNAL" appears. If no signal continues for nine minutes, this function will shut the television off automatically.



Press the MENU button

▲ ▼ To AUTO SHUT OFF

◀ ▶ To adjust AUTO SHUT OFF on or off.

DIGITAL-IN SIZE 1

The DIGITAL-IN option can only be displayed in the INITIAL SETUP menu when a 480p picture signal is being input to the DIGITAL-IN terminal. Refer to the screen illustration at the top-right of page 39.

This option adjusts the position when a 480p picture signal is being displayed on the screen.

There are two types of 480p picture signals: 640x480 and 720x480. If the displayed picture is slightly shifted, the position can be adjusted by selecting either SIZE1 or SIZE2.

Select DIGITAL-IN using the ▲ and ▼ arrows. Use the ◀ or ▶ arrow to select SIZE1 or SIZE2.

Note:

The DIGITAL-IN menu can only be displayed when a 480p picture signal is input to the Digital-In terminal and the picture is being displayed on the screen.

Picture Adjust

PICTURE ADJUST

The PICTURE ADJUST menu lets make precise adjustments to the television's picture. You can make adjustments to the picture's tint, color, contrast, brightness, and level of detail. By adjusting these levels individually, the overall picture quality can be changed.

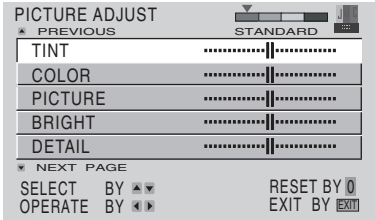

PICTURE ADJUST Menu

Access the onscreen menus by pressing MENU on your remote control. You may then either use the up and down arrows ▲▼ to scroll to the PICTURE ADJUST menu, or press MENU until the PICTURE ADJUST screen appears. Use the ▲▼ arrows to move to the setting you wish to change. You can make adjustments to any or all of the settings. When you select an item, the PICTURE ADJUST menu will disappear, leaving only the selected item onscreen. Use the ◀▶ arrows to make adjustments to the item. To make adjustments to a different item, press the ▲ or ▼ arrows to move to the next menu item, or press EXIT to return to normal television viewing. When you press "0", it resets your adjustments back to the factory settings.

TINT



The TINT level lets you adjust the levels of red and green in the picture. Press ◀ to increase the amount of red. Press ▶ to increase the amount of green. Use the ▲▼ arrows to move to the next setting or press EXIT to leave the menu. Your changes will be saved when you move to another setting or press EXIT.

COLOR



COLOR lets you make the overall color of the picture more subtle or more vivid. Press ◀ to make the colors more subtle. Press ▶ to make the colors more vivid. Use the ▲▼ to move to the next setting or press EXIT to leave the menu. Your changes will be saved when you move to another setting or press EXIT.

Note: You may leave the PICTURE ADJUST menu at any time by pressing EXIT. Any changes you have made will be saved.

Picture Adjust

Picture Adjust - Continued

PICTURE



The PICTURE level adjusts the contrast, or range between black and white in the picture. Press ◀ to decrease the range between the blacks and whites in the picture. Press ▶ to increase the range. Use the ▲ ▼ arrows to move to the next setting or press EXIT to leave the menu. Your changes will be saved when you move to another setting or press EXIT.

BRIGHT



The BRIGHT level lets you adjust the degree of light and darkness in the picture. Press ◀ to decrease the bright level. Press ▶ to increase the bright level. Use the ▲ ▼ arrows to move to the next setting or press EXIT to leave the menu. Your changes will be saved when you move to another setting or press EXIT.

DETAIL



DETAIL let's you adjust the sharpness of the picture. Press ◀ to decrease the level of detail. This will give you images with softer edges and make the picture seem "softer" overall. Press ▶ to increase the level of detail. This will give you sharper images with harder edges. Use the ▲ ▼ arrows to move to the next setting or press EXIT to leave the menu. Your changes will be saved when you move to another setting or press EXIT.

Note: You may leave the PICTURE ADJUST menu at any time by pressing EXIT. Any changes you have made will be saved.

Picture Adjust

Picture Adjust 2

The second PICTURE ADJUST menu lets make further adjustments to the television's picture and display qualities.

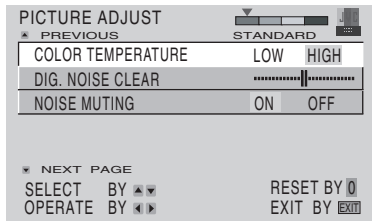

PICTURE ADJUST Menu

The second PICTURE ADJUST menu can be accessed by either pressing the ▼ button while at the last option of the first PICTURE ADJUST menu or by pressing MENU again.

COLOR TEMPERATURE LOW HIGH

With COLOR TEMPERATURE, you can decide how strong or dull the colors appear on the TV screen.

Use the ▲ ▼ arrows to select COLOR TEMPERATURE.

Use the ◀ or ▶ arrows to turn COLOR TEMPERATURE LOW or HIGH

DIG. NOISE CLEAR ||.....

With DIGITAL NOISE CLEAR, this helps take our static or noise from a channel that may not be coming in clearly.

Use the ▲ ▼ arrows to select DIG. NOISE CLEAR.

Use the ◀ or ▶ arrows to adjust the amount of noise reduction.

Press ◀ to decrease the noise reduction, or press ▶ to increase the noise reduction.

NOISE MUTING ON OFF

The NOISE MUTING setting inserts a grey screen over any channels that are not broadcasting or have signals too weak to have clear signals. Press the ◀ or ▶ arrows to turn NOISE MUTING on or OFF.

Sound Adjust

The SOUND ADJUST menu lets you tailor the television's sound to suit your personal taste. You can adjust the television's bass and treble output, as well as the speaker balance. You can also choose to receive broadcasts either stereo or mono sound, or listen to a Second Audio Program (SAP), if one is broadcast.

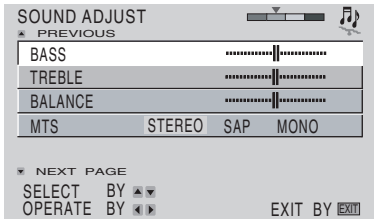

SOUND ADJUST Menu

Access the onscreen menus by pressing MENU on your remote control. You may then either use the up and down arrows ▲ ▼ to scroll to the SOUND ADJUST menu, or press MENU until the SOUND ADJUST screen appears. Use the ▲ ▼ arrows to move to the setting you wish to change. You can make adjustments to any or all of the settings.

BASS



The BASS level lets you adjust the level of low-frequency sounds. Press ◀ to decrease the bass level. Press ▶ to increase the level of bass. Use the ▲ ▼ to move to the next setting or press EXIT to leave the menu.

TREBLE



The TREBLE level lets you adjust the level of high-frequency sounds. Press ◀ to decrease the treble. Press ▶ to increase the treble. Use the ▲ ▼ to move to the next setting or press EXIT to leave the menu.

BALANCE



You can adjust the balance of sound output between the television's RIGHT and LEFT speakers with the balance control. Press ◀ to shift the balance to the left. Press ▶ to shift the balance to the right. Use the ▲ ▼ to move to the next setting or press EXIT to leave the menu.

Sound Adjust

Sound Adjust - Continued

MTS

STEREO

SAP

MONO

Many broadcasts today contain more than one audio signal. In addition to stereo and mono soundtracks, some broadcasts also contain a second soundtrack in a different language. Use MTS to select the audio signal you wish to listen to.

- Select **STEREO** for your normal listening needs. With this setting programs broadcast in stereo will be played by the TV in stereo. Programs broadcast in mono sound only will be played in mono sound.
- Select **MONO** if you are receiving a weak signal. Mono sound will usually give clearer sound from weak signals than will stereo. With this setting all broadcasts, mono and stereo, will be played in mono sound only by the television.
- Select **SAP** (Second Audio Program) to listen to an alternate soundtrack (if one is being broadcast). Alternate soundtracks may be the dialog of a program in a different language or additional information about a program topic. A logo will appear at the beginning of a program with SAP to inform you that an alternate soundtrack is available.

Some Sound Advice

You can tell if a program is broadcast in stereo by the position of the ON AIR arrow in the MTS menu. Unfortunately, some cable companies may “squash” the transmission of stereo programs because they have only monaural equipment. If you are connected to a cable system, the sound is at the mercy of that cable company. If they broadcast only monaural signals, your television will only receive a mono signal even if the program was originally broadcast in stereo.

Fortunately, most programs that are broadcast in stereo are aired on the major television networks. If you connect your TV to an antenna instead of cable, and set the tuner mode in the AUTO TUNER SETUP to “AIR” instead of “CABLE” you will be able to pick up stereo broadcasts in stereo.

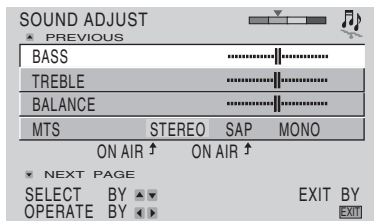

Clock/Timers

This CLOCK/TIMERS menu can be used to set the time of the built-in clock and set the ON/OFF TIMER function.

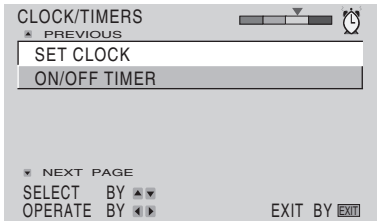

Access the on-screen menus by pressing the MENU button on your remote control. You may then either use the ▲ and ▼ arrows to select the CLOCK/TIMERS menu, or press the MENU button until the CLOCK/TIMERS screen appears.

Use the ◀ or ▶ arrows to move to the setting you wish to change.

You can make the setting or program.

Set Clock

The SET CLOCK function is described on page 30. If you need to set the SET CLOCK again, select the option from the CLOCK/TIMER menu by using the ▲ or ▼ arrows to move to the SET CLOCK option in the CLOCK/TIMER Menu. Select the option by pressing the ◀ or ▶ arrows. Please refer to page 30 for instructions on using the CLOCK/TIMER feature.

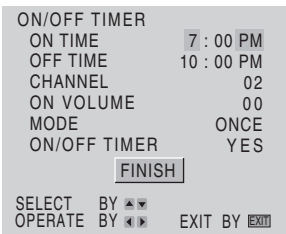

On/Off Timer

The ON/OFF TIMER lets you program your television to turn itself on or off. You can use it as an alarm to wake up, to help you remember important programs, or as a security device to make the house seem occupied when you're not at home.

You can select the ON/OFF TIMER option from the CLOCK/TIMERS menu by using the ▲ or ▼ arrows to move to the ON/OFF TIMER option in the ON/OFF TIMER Menu. Select the option by pressing the ◀ or ▶ arrows.

Clock/Timers

Setting the On/Off Timer

The On/Off timer lets you program your television to turn itself on or off. You can use it as an alarm to wake up, to help you remember important programs, or as a decoy when you're not home.



Press the MENU button



To ON/OFF TIMER



To operate (begins with ON TIME)



To set the hour (AM/PM) you want the TV to turn on



To move to minutes



To set the minutes



To accept ON TIME and move to OFF TIME (the time the TV will turn off). Set the OFF TIME the same way as ON TIME



To accept OFF TIME and move to CHANNEL



To select channel



To move to ON VOLUME



to set volume level



To move to MODE



Choose ONCE or EVERYDAY



To ON/OFF TIMER



Choose YES to accept the timer setting, choose NO if you don't wish to accept



To FINISH



To save settings

Note: The ON/OFF TIMER cannot be set to locked or guarded channels. In order for the ON/OFF TIMER to work, the clock must be set. In the event of the electric power being interrupted, the timer must be set again.

Initial Setup 3

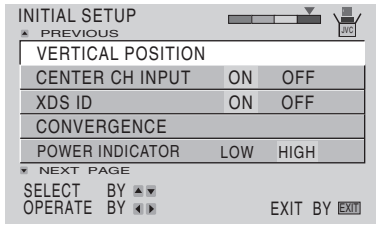

INITIAL SETUP Menu

Access the onscreen menus by pressing MENU on your remote control. You may then either use the up and down arrows ▲▼ to scroll to the INITIAL SETUP menu, or press MENU until the INITIAL SETUP screen appears. Use the ▲▼ arrows to move to the setting you wish to change. You can make adjustments to any or all of the settings.

VERTICAL POSITION

If you select the regular size with ASPECT, VERTICAL POSITION option is not viewed. This option allows you to adjust the vertical position of the picture on the screen. You can raise or lower the orientation of the picture by pressing the ▲ or ▼ arrows to move the picture up or down. When the picture is positioned the way you would like, press EXIT to save your settings and leave this option.

Vertical Position

VERTICAL POSITION allows you to adjust the screen position vertically when the ASPECT is set to PANORAMA, CINEMA or FULL.



Press the MENU button



to VERTICAL POSITION



to operate

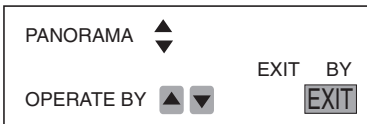

To adjust VERTICAL POSITION

NOTE: When the color of the mark changes to pink, it is impossible to adjust the position.

Initial Setup

CENTER CH INPUT

ON OFF

When you are using a surround system, you can substitute the speaker of this television for the center speaker of your surround system. Set CENTER CH INPUT to on when you use the speaker as the center speaker of your surround system.



Press the MENU button



to CENTER CH INPUT



to adjust CENTER CH INPUT on or off.

XDS ID

ON OFF

XDS ID allows you to display the call letter (station ID), network name and program name of the broadcasting company using the XDS signal



Press the MENU button



to XDS ID



to adjust XDS ID on or off.

POWER INDICATOR

LOW HIGH

POWER INDICATOR allows you to adjust the brightness of the power indicator



Press the MENU button



to POWER INDICATOR



to adjust POWER INDICATOR low or high.

Aspect

Your television can display images in one of four aspect ratios. The aspect ratio is the ratio of image width to height as displayed on the screen. The AV-56WP30 or AV-48WP30 has a “wide screen” with an aspect ratio of 16:9.

A traditional television picture has an aspect ratio of 4:3. Since you will likely view programs from several different ratios, this feature will help you adjust your picture image to match, giving you the best possible picture quality.

Press the ASPECT button on the remote control. The menu shown (left) will appear. To select the aspect ratio you wish to view, press the ASPECT button to move down the list. Each press will move to the next ratio, the onscreen display will change automatically. The aspect ratios are:

ASPECT
PANORAMA
CINEMA
FULL
REGULAR

- **PANORAMA** - With this ratio a normal 4:3 aspect picture is stretched to fit the dimensions of the 16:9 aspect screen.
- **CINEMA** - This ratio “zooms in” on the center part of a 4:3 aspect picture, blowing it up to fill the 16:9 screen.
- **FULL** - This is the ratio to use when watching 16:9 High-Definition broadcasts.
- **REGULAR** - The Regular ratio is used when you want to watch a 4:3 broadcast or recorded program without modifying the original picture to fit the dimensions of your 16:9 screen. The 4:3 picture will fill the AV-56WP30's or AV-48WP30's screen from top to bottom, while black bars will appear to fill up the remaining space along the picture's sides. The 4:3 picture will be centered within the boundaries of the 16:9 screen.

When you have selected the ASPECT ratio you wish to view, either press ENTER or wait a few seconds for the ASPECT menu to disappear. You may change the ASPECT at any time.

Aspect Ratios

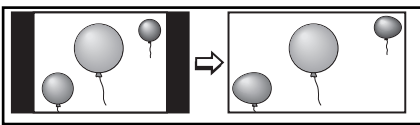

PANORAMA

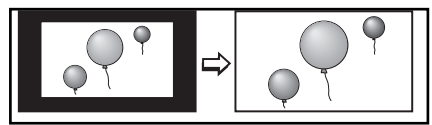

CINEMA

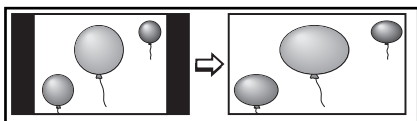

FULL

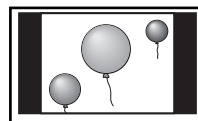

REGULAR

Adjusting CRT Color Convergence—

This TV has three color projection tubes: one for red, green, and blue. When mixed together in the proper portions, the output of these three color tubes can produce any color. To produce these colors, however, the beams must be precisely aligned over each other so that the colors can be mixed. The produce of aligning these picture beams is called “convergence”.

Attention:

- This adjustment will be needed only when the colors of the characters/lines are seperated and lack in distinction.
- If not, please don't perform the adjustment.

Colors may become seperated after the TV has been moved, or over a long period of time if regularly subjected to low levels of vibrations. If the colors become seperated, please perform the adjustments below again.



Press the MENU button



to CONVERGENCE



to operate

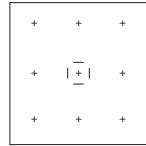

CONVERGENCE ADJUSTMENT SCREEN

The convergence adjustment screen appears with crosses (+) displayed in 9 locations.

Location where the crosses appear in 3 colors:

Convergence adjustment is required. Perform step 1 and 2.



Locations where the crosses are white:

The convergence is adjusted correctly



If all the crosses are white, no convergence adjustment is needed.

- 1) Use the number buttons on the remote control to select the location to be adjusted.

The location of the crosses correspond to the positions of the number buttons on the remote control. A box appears around the selected cross.

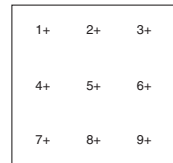

- 2) Adjust the three colored crosses until they overlap and appear as a single (white) cross.

- 1) Press the SELECT button to change the color of the box to the color of the cross you want to adjust (red or blue).

You cannot adjust the green cross.

- 2) Use the ▲▼ and ◀▶ buttons to adjust the position of the cross.

To cancel the adjustments before completing the procedure, press the EXIT button.

- 3) Press the ENTER button to end the convergence adjustment procedure.

If you do not use the TV controls for roughly one minute, the convergence adjustment screen automatically disappears.

Button Functions

MULTI SCREEN Function

Your Television has three kinds of screen: SPLIT (2 channels), POP (4 channels), and INDEX (12 channels)

SPLIT

Activate the Split-Screen option by pressing SPLIT on the remote control.

Two channels (or input) will now appear onscreen. The channel (or input) you were watching before pressing SPLIT will appear on the left, the new channel will appear on the right. The sound will continue to come from the main screen channel (or input). To turn Split-Screen off and return to normal television viewing, press SPLIT again.

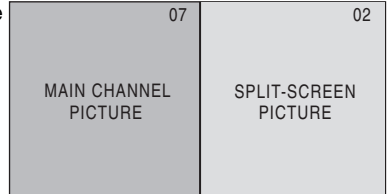

Note:

- Split-Screen functions will not work with locked channels or channels blocked by V-Chip ratings limits. A grey screen will display instead.
- With SPLIT Screen, the picture from the component terminal and HDCP terminal will not be displayed.
- The aspect of MAIN CHANNEL PICTURE becomes 16:9 when you input the picture of 480p, 720p and 1080i from the component terminal and HDCP terminal.
- After you press the SELECT button, and select SPLIT SCREEN, if you don't operate, the MAIN CHANNEL SCREEN will be automatically selected about 8 seconds later.

SWAP

You can exchange the channel (or input) displayed in the Split screen window for the main screen image by pressing SWAP button.

Note: This function will not work with SPLIT screen.

FREEZE

Pressing the FREEZE button causes the screen to change to the split-screen display with the still picture displayed on the right. In order to return to the normal display, press the FREEZE button once again.

Note: This function will not work with POP screen.

SELECT

With SELECT, you can select the picture (channel) while viewing POP or SPLIT screen. When you press SELECT button, the channel number on the top will be highlighted. Each press of SELECT will shift the channel.

ENTER

You can display the one picture on screen by pressing ENTER while using MULTI SCREEN Function. Press SELECT or highlight the channel number before pressing ENTER.

Button Functions

INDEX

This allows you to quickly look at up to 12 channels at a time so that you can decide which one to watch.

1	2	3	4
5	6	7	8
9	10	11	12

Note: Only RF input signal will be displayed.

POP

you can view three separate pictures (still images) on screen on the right side of the TV's main picture. The picture of the still image will be renewed in order (from top to bottom).

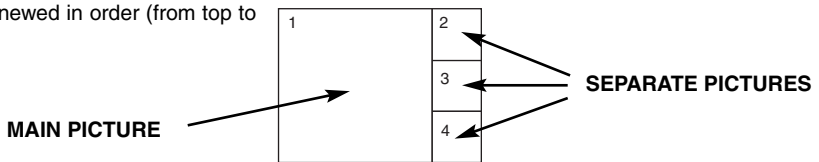

To change the channel of separate pictures:

- Press the **SELECT** button and select the separate picture which you want to change. Press the **NUMBER** buttons and select the channel.

To display the channel of the separate picture on the full screen:

- Press the **SELECT** button and select the separate picture which you want to display on the full screen. Press the **ENTER** button.

Note:

- This function will not work when the picture from component terminal or HDCP terminal is displayed.
- **SWAP** function will not work.

Cable Box Note:

The 2-Tuner Multi Screen function may not operate when used with certain cable boxes. This is because while some models of cable boxes may receive up to 181 channels, and may only send the signal from one channel to your television. (Please refer to diagram on page 14). For the 2-Tuner Multi screen function to operate correctly, it must have access to all available channels. Since the television is receiving the signal from only one channel from the cable box, it is impossible for the 2-Tuner Multi screen function to display a second, different channel. Because there are many different models of cable boxes in use today, if you are having problems operating your 2-Tuner Multi screen function feature with your cable box, we recommend you contact your local cable company for connection advice.

Button Functions

MENU

The MENU button allows you to access JVC's onscreen menu system. Press MENU to activate the onscreen menu system.

- See individual topics (like "Picture Adjust") for specific information on using those menu screens.

EXIT

Press the EXIT button to leave a menu screen.

DISPLAY

The DISPLAY screen shows the current status of timers and inputs.



Press the DISPLAY button to activate.

07	XYZ	UVW
JAZZ FESTIVAL		
NOW		12 : 20 PM
SLEEP TIMER		OFF
ON/OFF TIMER		EVERYDAY
ON TIME		7 : 00 PM
OFF TIME		10 : 00 PM

The screen on the left shows the following information:

- The channel or AV input (RF-input, 07)
- The call letter (XYZ)
- The network name (UVW)
- The program name (JAZZ FESTIVAL)
- The current time (12:20 pm)
- SLEEP TIMER status/minutes remaining (The SLEEP TIMER is off)
- ON/OFF TIMER status (Set to turn on everyday at 7:00 pm, off at 10:00 pm)

Each press of the Display button moves to a different display mode:

Display - Full screen shown above

Time - Shows the current time only

Channel - Shows the current channel only

Off - Turns all displays off

SLEEP TIMER

The SLEEP TIMER can turn the TV off for you after you fall asleep. Program it to work in intervals of 15 minutes, for a total time of up to 180 minutes.



Press the SLEEP TIMER button to activate.



Sleep Timer Message:

20 seconds before the automatic timer shutoff occurs, this message will appear onscreen:

GOOD NIGHT!!
PUSH SLEEP TIMER BUTTON
TO EXTEND

You have 20 seconds to press the SLEEP TIMER button to delay the shutoff for another 15 minutes. If you do not press the button, the television will automatically shut off.

Button Functions

BBE

BBE high definition audio adds natural, clear, extraordinary sound quality to any program. Use the BBE button to turn the BBE high definition audio filter ON or OFF.

HYPER SURROUND

Creates a deep, three-dimensional sound effect by changing the audio through the TV's front firing speakers. Press the Hyper Sur. (SURROUND) button to turn the effect on or off.

MUTING

The MUTING button instantly turns the volume down completely when you press it.



MUTING

The volume level will instantly go to zero.

- To restore the volume to its previous level, press MUTING again.

VIDEO STATUS

The VIDEO STATUS button gives you a choice of three TV picture display settings, including display of your own setting preferences.

Standard - Resets the picture display to the original factory settings

Dynamic - Heightens contrast and sharpness

Theater - Gives a rich, film-like look to video.



Press the VIDEO STATUS button to choose a setting.



NATURAL CINEMA

Natural Cinema corrects the problem of blurred edges which may occur when viewing a program originally shot on film (such as motion pictures) or animation. If you notice blurring at the edges of these programs, press NATURAL CINEMA and set it to AUTO. Natural Cinema helps correct conversion errors that occur when film, which is shot at 24 frames-per-second, is broadcast at the television rate of 30 frames-per-second.

Natural Cinema should not be used when viewing regular television programs or video tapes. When viewing such programs, set Natural Cinema to OFF.

NOTES: The Natural Cinema mode is automatically set to "AUTO" in the following cases:

- Turning on or off.
- Changing the channel or input mode.
- Using Multi-Screen functions.

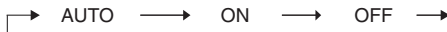

ASPECT

Press the ASPECT button to access ASPECT ratio settings menu. You can choose one of four display ratios for your television picture. For more information on the ASPECT ratio feature and its settings, see page 51.

Notes: BBE is a registered trademark of BBE Sound, Inc. For U.S., licensed from BBE Sound, Inc. under USP 4638258, 4482866 and 5510572. For Canada, licensed from BBE Sound, Inc. BBE is a registered trademark of BBE Sound, Inc.

Button Functions

NUMBER BUTTONS - 10 KEY PAD

Use the number buttons on the remote control to move directly to a specific channel. For example, to move to channel 7:

 0 (Zero)

 7 (Seven)

100+ BUTTON

Use the 100+ button to directly access channels above Channel 99. For example, to move to channel 124:

 100+

 2 (Two)

 4 (Four)

RETURN+

The RETURN+ button has two functions:

Return - Returns to the channel viewed just before the channel currently onscreen.

Return+ - Lets you program a specific channel to return to while scanning through the channels. To program:

 RETURN+ and hold for three seconds.

RETURN CHANNEL
PROGRAMMED !

You can now scan through the channels using the CH+/- buttons.

 RETURN+

You will return to your programmed channel.

- To cancel your RETURN+ channel, press and hold the RETURN+ button for three seconds. The message "RETURN CHANNEL CANCELLED!" will appear.
- RETURN+ works only with CHANNEL+/- . Pressing any number key will cancel RETURN+.

V-CHIP

By pressing the remote control V-CHIP button, the V-chip rating information for the program which is being received is displayed on the screen.

If the V-chip rating information is not being sent, "UNRATED" is displayed on the screen.

If the zero ("0") button is pressed while the V-chip rating is displayed on the screen, all categories with the same or a higher V-chip rating will be blocked.

For example, if you block movies rated NC-17, movies rated X will also be blocked.

- V-chip blocks can be manually set one at a time by using the V-chip option in the INITIAL SETUP menu. For detailed information about V-chip ratings and V-chip manual settings, refer to pages 33 to 38.

Button Functions

INPUT

The AV-56WP30 or AV-48WP30 can receive signals from a variety of sources. Use the INPUT button to select the signal source: Antenna (for signals from the RF coaxial cable) or VIDEO 1 through VIDEO 4 (for signals from an audio/video device like a DVD player or VCR) or DIGITAL-IN.

The INPUT menu will appear when you press INPUT. To select a signal source, press INPUT, each press will move to the next item in the menu. If no device is connected to an input, a grey screen will appear. When you have selected a signal source, either press EXIT to leave the menu or wait a few seconds for the menu to disappear automatically.

- Pressing CH+/- will automatically select the antenna (12) as the source.

INPUT
12
VIDEO-1
VIDEO-2
VIDEO-3
VIDEO-4
DIGITAL-IN

INPUT Menu

MENU (on TV's Front Panel)

You can also access the onscreen menu system by pressing the MENU button on the television's front panel. When you press this button, an additional onscreen menu will appear.

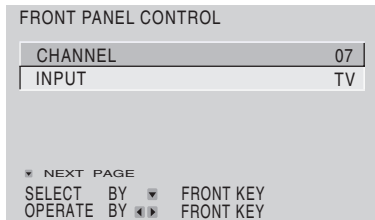

This menu will show you the current channel (07 on the menu shown above), the current signal input in use.

You can move to the other onscreen menus by pressing the ▼ arrow.

LIGHT

The remote control includes illuminated buttons for key features like CH+/- and VOL+/. Press the LIGHT button to turn the illumination on. The illumination will shut off automatically after a few seconds.

Button Functions

VCR BUTTONS

You can use this remote control to operate the basic functions of your VCR. These functions include: play, record, rewind, fast-forward, stop, pause, channel scan, TV /VCR, power on, and power off.

Move the selector switch to VCR to operate.

- The remote is preset with the code 000 to control JVC-brand VCR's. For any other manufacturer's brand VCR, please see the code chart and instructions on page 23.

DVD BUTTONS

You can also use this remote control to operate the basic functions of your DVD player. These functions include: play, rewind, fast-forward, stop, still/pause, previous/next, tray open/close, power on, and power off.

Move the selector switch to DVD to operate.

- The remote is preset with the code 000 to control JVC-brand DVD players. For any other manufacturer's brand DVD player, please see the code chart and instructions on page 24.

TV/CATV SWITCH

Use either the television's own tuner or a cable box to select channels. Set this switch to TV to operate the television's built-in tuner. Move the switch to CATV to operate a cable box.

- See page 22 for information on programming your remote for cable box operation.

VCR/DVD SWITCH

You can control a VCR or DVD player with the buttons on the lower part of the remote control. Use the VCR/DVD selector switch to choose either VCR or DVD operation.

- See pages 23 and 24 for information on programming your remote with VCR and DVD operating codes.

Troubleshooting

PROBLEMS	CHECK
There is no power.	<ul style="list-style-type: none">- See if the power cord became unplugged.- Check for a blown fuse or circuit breaker or a power outage.
There is no picture or sound	<ul style="list-style-type: none">- The antenna could be disconnected.- The input mode (TV/Video) could be set improperly. See page 58.- The tuner (AUTO TUNER SETUP) could be set improperly. See page 29.- The TV station may be having difficulties. Check to see if other stations are working.
Remote control is not operating properly or at all	<ul style="list-style-type: none">- Check to see that the batteries are still working and properly installed.- Make sure the remote has a clear sight path to the TV.- Check that the TV/CATV switch is in the proper position.- You may be too far from the TV. You must be within 23 feet (7 meters).- Use the remote control while pointing it at the screen.
You cannot select a certain channel	<ul style="list-style-type: none">- Make sure the channels have been programmed. See "Channel Summary" page 32.- Check to see if the channel is locked. See "Channel Summary - Lock" page 32.
The power turns off by itself	<ul style="list-style-type: none">- Make sure the set did not become unplugged.- Perhaps the ON/OFF TIMER is set. See page 50.- Check to see if the Sleep Timer was set. See page 55.
It does not operate correctly	<p>This television is operated by a microprocessor. It is possible that external noise or interference is causing the problem. If the television does not function correctly, remove the electric plug from the wall outlet and wait a while before inserting it into the wall outlet again and operating the television.</p>
The clock is wrong	<p>The power was interrupted and the clock was not reset. See page 30.</p>
The color quality is poor	<ul style="list-style-type: none">- Tint and Color may be improperly adjusted. See page 42.- The VIDEO STATUS mode may be turned to the wrong setting. See page 56.- If red, green and blue shadows appear on the contours of the image on the screen, it is necessary to adjust the CRT color convergence. See page 52.
There are lines across the picture	<p>There could be interference from another electrical appliance, such as a computer, another TV or VCR. Move any such appliances further away from the TV.</p>
The picture is spotted	<p>There could be interference from a high-wattage appliance, like a hairdryer or vacuum, operating near-by. Move the antenna away from the appliance or change to a coaxial cable connection which is less prone to interference.</p>

Troubleshooting

PROBLEMS	CHECK
There are double pictures (ghosts)	A building or passing airplane can reflect the original signal and produce a second, slightly delayed one. Adjust your antenna position.
Picture is snowy (image noise)	Your antenna may be damaged, disconnected or turned. Check the antenna connection page 10 in Quick Setup. If the antenna is damaged, replace it.
Screen is 80% black	The Closed Caption Text mode is on. Turn it off in the CLOSED CAPTION Menu, see page 39.
Stereo or bilingual programs cannot be heard	Make sure the MTS settings are correct. See "MTS" on page 46.
There is no sound from the TV's speakers	The Center CH Input may be turned on. See page 48.
Static electricity	It is normal to feel static electricity if you brush or touch the screen.
You hear occasional crackling sounds	It is normal for the TV to make crackling sounds when first turned on or off. Unless the sound or picture becomes abnormal, this is fine.

The following are not malfunctions.

- The television may make a creaking sound if the temperature of the room or the temperature of the inside of the television changes. If there is no problem with the screen or sound, then there is no need to worry.
- The operation of this television is not guaranteed below 0°C. If the power is turned on when the temperature is below 0°C, the picture may be disturbed. Use the television when the temperature is 0°C or higher.
- Although the picture may be temporarily disturbed and noise may be seen on the screen if the power is turned on immediately after it has been turned off, this is not a malfunction.

Refer to the table below to check the condition. If you think that there is a problem, contact the JVC Service Center where you purchased the television.

Appendix A

Caring for the Cabinet

Normally, light dusting with a soft, non-scratching duster will keep your TV clean.

If you wish to wipe down the television, first unplug it. Then wipe gently with a soft cloth, slightly moistened with water. You can add a few drops of mild liquid detergent to the water to help remove spots of oily dirt.

DO NOT allow liquid to enter the TV through the ventilation slots.

DO NOT use strong or abrasive cleaners on the TV.

DO NOT spray liquids or cleaners directly on the TV's surface.

DO NOT rub or scrub the TV harshly. Wipe the set gently with a soft cloth.

Caring for the Screen

The screen of the AV-56WP30 or AV-48WP30 is treated with an electrostatic-proof coating.

When it gets dirty, wipe it gently with a soft cloth. If the screen is very dirty, wipe it down with a cloth dipped in a diluted kitchen cleaner and thoroughly wrung-out. Then wipe immediately after with a clean, dry cloth.

Do not apply alcohol, organic solvents (like acetone), acidic or alkaline cleansers to the screen. These will remove the coating layer and cause discolorations.

Do not push or hit the screen. This could cause scratches on the screen surface and image distortions.

Limited Warranty

JVC COMPANY OF AMERICA warrants this product and all parts thereof, except as set forth below **ONLY TO THE ORIGINAL PURCHASER AT RETAIL** to be **FREE FROM DEFECTIVE MATERIALS AND WORKMANSHIP** from the date of original retail purchase for the period shown below. ("The Warranty Period")

PARTS 1 YEAR	LABOR 1 YEAR
---------------------	---------------------

This limited warranty is valid only in the fifty (50) United States, The District of Columbia and Commonwealth of Puerto Rico.

WHAT WE WILL DO:

If this product is found to be defective within the warranty period, JVC will repair or replace defective parts at no charge to the original owner. Such repair and replacement services shall be rendered during regular business hours by JVC authorized service centers. Parts used for replacement are warranted only for the remainder of this Warranty Period. Televisions with a screen size of 25 inches and larger are covered on an in-home basis.

WHAT YOU MUST DO FOR WARRANTY SERVICE:

Either contact the selling dealer (retailer) or call 1-800-252-5722 to arrange In-home service. In-home service will require clear access to the Television by the service technician.

WHAT IS NOT COVERED:

This limited warranty provided by JVC does not cover:

1. Products which have been subject to abuse, accident, alteration, modification, tampering, negligence, misuse, faulty installation, lack of reasonable care, or if repaired or serviced by anyone other than a service facility authorized by JVC to render such service, or if affixed to any attachment not provided with the products, or if the model or serial number has been altered, tampered with, defaced or removed.
2. Initial installation, installation and removal from "built-in" entertainment centers and other mounting systems.
3. Operational adjustments covered in the Owner's Manual, normal maintenance, including head cleaning.
4. Damage that occurs in shipment, due to an act of God, and cosmetic damage.
5. Signal reception problems and failures due to line power surge.
6. Products used for commercial purposes (including but not limited to rental).
8. Accessories.
9. Batteries (except that Rechargeable Batteries are covered for 90 days from date of purchase).

There are no express warranties except as listed above.



Limited Warranty

THE DURATION OF ANY IMPLIED WARRANTIES, INCLUDING THE IMPLIED WARRANTY OF MERCHANTABILITY, IS LIMITED TO THE DURATION OF THE EXPRESS WARRANTY HEREIN.

JVC SHALL NOT BE LIABLE FOR THE LOSS OF USE OF THE PRODUCT, INCONVENIENCE, OR ANY OTHER DAMAGES, WHETHER DIRECT, INCIDENTAL OR CONSEQUENTIAL (INCLUDING, WITHOUT LIMITATION, DAMAGE TO TAPES, RECORDS OR DISCS) RESULTING FROM THE USE OF THIS PRODUCT, OR ARISING OUT OF ANY BREACH OF THIS WARRANTY, ALL EXPRESS AND IMPLIED WARRANTIES, INCLUDING THE WARRANTIES OF MERCHANTABILITY AND FITNESS FOR PARTICULAR PURPOSE, ARE LIMITED TO THE WARRANTY PERIOD SET FORTH ABOVE.

Some states do not allow the exclusion of incidental or consequential damages or limitations on how long the warranty lasts, so these exclusions or limitations may not apply to you. This warranty gives you specific legal rights and you may also have other rights which vary state to state.

JVC COMPANY OF AMERICA
DIVISION OF JVC AMERICAS CORP.

1700 Valley Road
Wayne, New Jersey 07470

<http://www.jvc.com>

REFURBISHED PRODUCTS CARRY A SEPARATE WARRANTY. THIS WARRANTY DOES NOT APPLY. FOR DETAILS OF REFURBISHED PRODUCT WARRANTY, PLEASE REFER TO THE REFURBISHED PRODUCT WARRANTY INFORMATION PACKAGED WITH EACH REFURBISHED PRODUCT.

For customer use:

Enter below the Model No. and Serial No. which is located either on the rear, bottom or side of the cabinet.

Retain this information for future reference.

Model No.: _____

Serial No.: _____

Purchase Date: _____

Name Of Dealer: _____

Authorized Service Centers

QUALITY **JVC** SERVICE

HOW TO LOCATE YOUR JVC SERVICE CENTER

TOLL FREE: 1 (800) 537-5722

<http://www.jvc.com>

Dear Customer,

In order to receive the most satisfaction from your purchase, please read the instruction booklet before operating the unit. In the event that repairs are necessary, call our Customer Relations Department at 1-800-537-5722 or visit our website at **www.JVC.com**

Remember to retain your Bill of Sale for Warranty Service.

Don't service the television yourself

Caution

To prevent electrical shock, do not open the cabinet. There are no user serviceable parts inside. Please refer to qualified service personnel for repairs.

Accessories

To purchase accessories for your JVC product, please call toll free: 1 (800) 882-2345 or on the web at **www.JVC.com**

For service in Canada

To locate your local JVC service center or dealer in Canada please call:

In Eastern Canada:
1 (416)293-1311

In Western Canada:
1 (604)270-1311

En Français (Montréal):
1 (514)871-1311

Or visit us on the web at **www.JVC.ca**

Specifications

Model	AV-56WP30	AV-48WP30
Type	Rear Projection Television	
Reception Format	NTSC, BTSC System (Multi-Channel Sound) 1080i DTV digital broadcast ready	
Reception Range	VHF 2 to 13, UHF 14 to 69 Sub, Mid, Super, Hyper and Ultra bands (180 channel frequency synthesizer system)	
Power Source	AC 120V, 60 Hz	
Power Consumption	248W	
Screen Size	56 inch / 142 cm measured diagonally, 16:9 ratio	48 inch / 122 cm measured diagonally, 16:9 ratio
Speakers	16 cm round X 2, 5.5 cm round X 2	13.5 cm round X 2, 5.5 cm round X 2
Audio Output	Full Range - 10W X 2	
Antenna Terminal	75 ohms (VHF/UHF) (F-type connector)	
External Input Jacks	Video: 1 Vp-p, 75 ohms Audio: 500 mVrms (-4dBs) high impedance	
Component Input Jack	Y: 1Vp-p positive, 75 ohms (negative sync provided) Pb/Pr: 0.7 Vp-p 75 ohms	
S-Video Input Jacks	Y: 1Vp-p positive, 75 ohms (negative sync provided) C: 0.286 Vp-p (burst signal), 75 ohms	
Audio Output Jacks	FIX: 500mVrms (-4dBs) Low impedance (1000 Hz when modulated 100%)	
AV Compu Link EX Jack	3.5 mm mini jack X 1	
Digital-In	DVI-D Single Link 19 pin Note: The Digital-In terminal is not compatible with picture signals of a personal computer	
Dimensions (in) W X H X D (cm)	53 7/8" X 54 5/8" X 26 3/8" 136.8 X 138.6 X 66.7	47 1/4" X 49" X 24" 120.0 X 124.4 X 60.9
Weight (lbs / kg)	209.0 (lbs) / 95.0 (kg)	179.0 (lbs) / 81.0 (kg)
Accessories	Illuminated remote control unit / AA batteries X 2	

*Specifications subject to change without notice.

JVC COMPANY OF AMERICA

Division of JVC Americas Corp.

1700 Valley Road

Wayne, New Jersey, 07470



JVC CANADA, INC.

21 Finchdene Square

Scarborough, Ontario

Canada, M1X 1A7