

HS 100 Home Cinema System

OWNER'S MANUAL

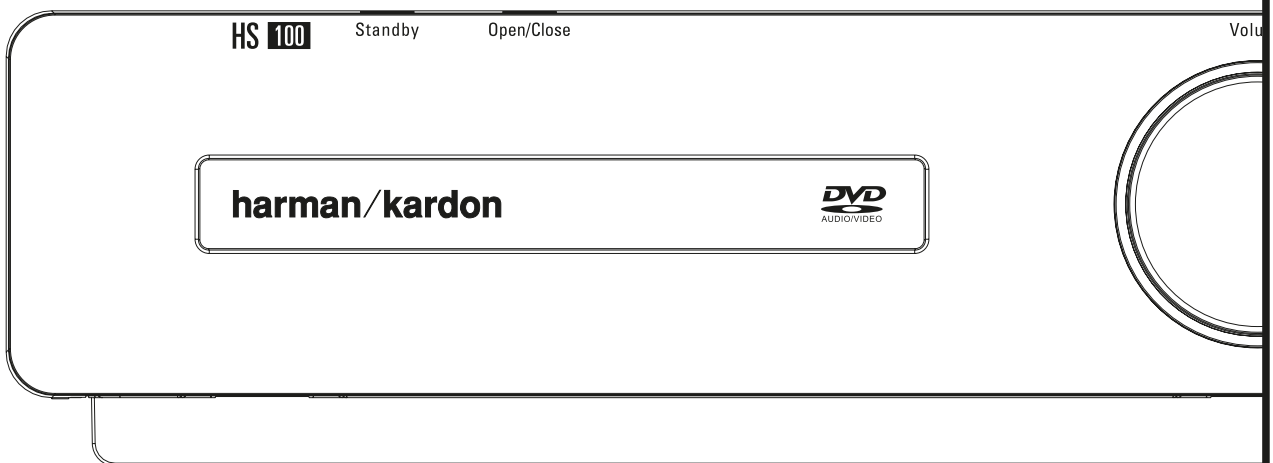

harman/kardon®

Power for the Digital Revolution®

Table of Contents

Page

3	Introduction
4	Safety Information
4	Unpacking
5	Terminology
6	Front Panel Controls
7	Front Panel Display
8	Rear Panel Connections
9	Remote Control
11	Basic Information
11	About This Manual
11	Regional Coding

System Connection

12	Installation and Connections
12	Audio Connections
12	Video Connections
12	Optional Audio Connections
13	Speaker Placement
13	First Turn On
13	Connecting AC Power

Playback Basics

14	Basic Playback
14	Disc Playback Features
14	Skipping tracks or titles/chapters
14	Fast Motion Playback/Fast Search
14	Freeze Frame and Frame Advance (with DVD only)
14	Slow Motion Playback (with DVD only)
14	Surround Mode

System Setup

15	System Defaults
15	Setup Menu
15	System Settings
15	Display Language
15	Preferred Subtitle Language
15	Panel Time-Out
15	Status Bar Time-Out
15	Parental Control
15	Disc Settings Memory
15	PBC Support
15	Screen Saver
15	Show Angle Icon
15	Audio Settings
15	Preferred Audio Language
15	Dynamic Range
16	Audio Adjustment
16	Delay Unit
16	Tone Control
16	Bass Level
16	Treble Level
16	DVD Sound Mode
16	Audio Adjustment
16	Delay
16	Output Level Adjustment
16	Video Settings
16	Aspect Ratio
16	TV Standard
16	Scan Type
16	Video Output
16	Scart Output
16	Video Adjustment

Test Screen

17	Test Screen
17	TV Picture Adjustment with Test Screen

Player Menu

18	Using the Status Bar Menu
18	Player Menu

18	Information Displays
18	Programmed Play

Radio Menu

19	Rearranging the station list
19	Selecting presets
19	Removing presets
19	RDS Station ID
19	Surround Mode for Tuner

TV Menu, AUX Menu, Digital In Menu

20	TV Menu
20	AUX Menu
20	Digital Menu
20	Surround Mode Chart

DVD Languages Codes

21	Languages Codes
----	-----------------

Troubleshooting

22	Troubleshooting
----	-----------------

Glossary

24	Glossary
----	----------

Specifications

25	Specifications
----	----------------

Declaration of Conformity



We, Harman Consumer Group International
2, route de Tours
72500 Château-du-Loir,
FRANCE

declare in own responsibility, that the product described
in this owner's manual is in compliance with technical
standards:

EN 55013:2001 + A1:2003

EN 55020:2002 + A1:2003

EN 61000-3-2:2000

EN 61000-3-3:1995 + A1:2001

EN 60065:2002

Jurjen Amsterdam
Harman Consumer Group International
06/05

Typographical Conventions

In order to help you use this manual with the remote control, front-panel controls and rear-panel connections, certain conventions have been used.

EXAMPLE – (bold type) indicates a specific remote control or front-panel button, or rear-panel connection jack

EXAMPLE – (OCR type) indicates a message that is visible on the front-panel information display

1 – (number in a square) indicates a specific front-panel control

1 – (number in a circle) indicates a rear-panel connection

1 – (number in an oval) indicates a button or indicator on the remote

A – (letter in a square) indicates an indicator on the front panel display

The appearance of the text or cursor for your receiver's on-screen menus may vary slightly from the illustrations in this manual. Whether the text appears in all uppercase or upper- and lowercase characters, performance and operation remain the same.

Introduction

Thank you for choosing Harman Kardon!

With the purchase of a Harman Kardon HS 100 you are about to begin many years of listening enjoyment.

Designed to provide all the excitement and detail of movie soundtracks and every nuance of musical selections, the HS 100 is truly a multichannel system for the new millennium.

The HS 100 has been engineered so that it is easy to take advantage of all the power of its digital technology. To obtain the maximum enjoyment from your new system, we urge you to read this manual. A few minutes spent learning the functions of the various controls will enable you to take advantage of all the power the HS is able to deliver.

If you have any questions about this product, its installation or its operation, please contact your retailer or custom installer. They are your best local sources of information.

Description and Features

The HS 100 is among the most versatile home cinema systems available, incorporating an Audio Video Controller, a DVD Audio player and a complete 5.1 loudspeaker system in one complete system solution. In addition to Dolby Digital and DTS decoding for digital sources, the Dolby Pro Logic II mode for Matrix surround-encoded or Stereo recordings is available for use with sources such as CD, VCR, TV broadcasts and the system's own FM tuner.

To enable you to get the maximum quality from DVDs, the HS 100 is equipped with the latest in design techniques, including advanced 10-bit video digital-to-analog converters (DAC) and Video (composite), S-Video and RGB video (RGB via SCART) outputs, to ensure that you get all the quality inherent in today's DVD medium. For optimum playback of NTSC and PAL DVD with compatible high-definition display devices, the HS 100 is equipped with progressive component video outputs.

NOTE: This player is designed and manufactured for compatibility with Region Management Information that is encoded on most DVD discs. This player is designed only for playback of discs

A wide range of programming features makes it easy to program an evening's worth of entertainment. When playing DVDs, easy-to-understand on-screen menus and icons make it simple to change languages, soundtracks, subtitles or aspect ratio, while a parental-lock function enables you to control which discs may be viewed by younger members of the household.

Disc formats supported by this player

The unit can play the following disc formats (8 cm and 12 cm size):

- DVD-AUDIO
- DVD
- DVD-R
- DVD-RW
- DVD+R
- DVD+RW
- CD
- CD-R
- CD-RW
- VCD
- S-VCD

NOTE: Due to differences in the format of certain discs, it is possible that some discs may include a mix of features that are not compatible with the DVD. Similarly, although the DVD is capable of a wide range of features, not all discs include every capability of the DVD system. For example, although the DVD is compatible with multi-angle discs, that feature is only possible when the disc is specially encoded for multiple-angle play. In addition, the DVD is capable of playing back both Dolby Digital and DTS soundtracks, but the number and types of tracks available will vary from disc to disc. To make certain that a specific feature or soundtrack option is available, please check the options noted on the disc jacket.

- Playback capability for CD-R, CD-RW, WMA, JPEG, MP3, VCD/SVCD, DVD-R, DVD+R, DVD-RW and DVD+RW discs may vary due to variations in the quality of the disc and the recorder used to create the disc.

with Region Code 2, or for discs that do not contain Region Code information. If there is any other Region Code on a disc, that disc will not play on the DVD.



Upgradeability via Internet

The "firmware" controlling the functionality of the Harman Kardon DVD is fully upgradeable. In the event of future improvements to its operations and features, it will be possible to download firmware upgrades from www.harmankardon.com/International/. All you have to do is create a CD-R with the data and insert it in the DVD for an automatic upgrade.

- Plays a Wide Range of Video and Audio Formats, Including DVD-Video Discs, VCD, Standard CD Audio Discs, CD-R/RW, DVD-R/RW, DVD+R/RW, Audio Discs and MP3 Discs
- DVD-Audio Playback for Richer Detail, Expanded Dynamic Range and Improved Realism
- Extensive Bass Management Options for DVD-Audio with Speaker Setup, Output Level Adjustment and Delay Settings
- High-Quality Video Playback 10-Bit DACs, Progressive Scan and Component Video Outputs
- Easy-to-Use On-Screen Navigation System
- Playback of MP3 and Windows® WMA Audio Discs and JPEG image files
- Simultaneous Playback of MP3 and JPEG files
- Extensive Programming Capability for Audio and Video Discs
- Parental Lock Controls Prevent Unauthorized Viewing of Restricted Movies
- Multiple Options for Language, Soundtrack and Subtitle Selection
- Multiple-Angle Capabilities With Specially Encoded DVD Discs
- Ergonomically Designed Remote Control
- Multiple digital inputs and outputs
- On-screen menu and display system

IMPORTANT NOTES:

This manual should be read in conjunction with the owners manual of the accompanying loudspeaker system. The instructions found therein should be followed with respect to loudspeaker operation and safety.

Only use the HS 100 controller with the loudspeaker system supplied. Failure to do so may cause damage to either the controller or the loudspeakers and will invalidate any warranty.

All of the optional system settings have been preset at our factory for correct operation of the system. All you have to do is insert a disc, sit back, and enjoy a great home theater experience.

You may want to change some of the optional settings. A description of all the optional settings and instructions for changing them are found in the second half of the manual.

This system was designed to provide you with many years of reliable operation with a minimum

Introduction / Safety Information

of care and maintenance. Every component in your system was in perfect working condition when it left our factory. If you experience any problems with the set-up or operation of this system, please review the Troubleshooting Guide at the end of this manual before you contact your authorized Harman Kardon dealer.

Important Safety Information

Verify Line Voltage Before Use

Your HS 100 has been designed for use with 220-240-Volt AC current. Connection to a line voltage other than that for which it is intended can create a safety and fire hazard and may damage the unit.

If you have any questions about the voltage requirements for your specific model, or about the line voltage in your area, contact your dealer before plugging the unit into a wall outlet.

Do Not Use Extension Cords

To avoid safety hazards, use only the power cord attached to your unit. We do not recommend that extension cords be used with this product. As with all electrical devices, do not run power cords under rugs or carpets or place heavy objects on them. Damaged power cords should be replaced immediately by an authorized service depot with a cord meeting factory specifications.

Handle the AC Power Cord Gently

When disconnecting the power cord from an AC outlet, always pull the plug, never pull the cord. If you do not intend to use the unit for any considerable length of time, disconnect the plug from the AC outlet.

Do Not Open the Cabinet

There are no user-serviceable components inside this product. Opening the cabinet may present a shock hazard, and any modification to the product will void your guarantee. If water or any metal object such as a paper clip, wire or a staple accidentally falls inside the unit, disconnect it from the AC power source immediately, and consult an authorized service station.

Installation Location

■ To assure proper operation and to avoid the potential for safety hazards, place the unit on a firm and level surface. When placing the unit on a shelf, be certain that the shelf and any mounting hardware can support the weight of the product.

■ Make certain that proper space is provided both above and below the unit for ventilation. If this product will be installed in a cabinet or other enclosed area, make certain that there is sufficient air movement within the cabinet. Under some circumstances a fan may be required.

■ Do not place the unit directly on a carpeted surface.

■ Avoid installation in extremely hot or cold locations, or an area that is exposed to direct sunlight or heating equipment.

■ Avoid moist or humid locations.

■ Do not obstruct the ventilation slots on the top of the unit, or place objects directly over them.

Cleaning

When the unit gets dirty, wipe it with a clean, soft, dry cloth. If necessary, wipe it with a soft cloth dampened with mild soapy water, then a fresh cloth with clean water. Wipe dry immediately with a dry cloth. NEVER use benzene, aerosol cleaners, thinner, alcohol or any other volatile cleaning agent. Do not use abrasive cleaners, as they may damage the finish of metal parts. Avoid spraying insecticide near the unit.

Moving the Unit

Before moving the unit, be certain to disconnect any interconnection cords with other components, and make certain that you disconnect the unit from the AC outlet.

Unpacking

The carton and shipping materials used to protect your new receiver during shipment were specially designed to cushion it from shock and vibration. We suggest that you save the carton and packing materials for use in shipping if you move, or should the unit ever need repair.

To minimize the size of the carton in storage, you may wish to flatten it. This is done by carefully slitting the tape seams on the bottom and collapsing the carton. Other cardboard inserts may be stored in the same manner. Packing materials that cannot be collapsed should be saved along with the carton in a plastic bag.

If you do not wish to save the packaging materials, please note that the carton and other sections of the shipping protection are recyclable. Please respect the environment and discard those materials at a local recycling center.

Copyright

Audio-visual material may consist of copyright works which must not be recorded without the permission of the owner of the copyright. Please refer to relevant laws covering copyright protection.

Copy protection

This DVD player supports Macrovision copy protection. On DVD discs that include a copy protection code, if the contents of the DVD disc are copied using a VCR, the copy protection code prevents the videotape copy from playing normally.

For Optimum Performance

The controller is a precision device that is constructed using extremely accurate technology. Soiling or friction affecting the pickup lens or disc drive can impair the image quality. In the worst case, neither video nor audio will be played back. To obtain optimum picture quality, the player should be checked (cleaning and replacement of some parts) every 1,000 hours. Note that this period varies depending on the environment (temperature, humidity, dust) in which the player is used.

Do not attempt to clean the pickup lens yourself.

Unpacking

Check that you have the following items:

- HS 100 Controller (1)
- HKTS 7/230 Loudspeaker System
- Remote control (1)
- AAA batteries (2)
- SCART A/V cable
- FM antenna (1)
- Owner's Manual (1)



CAUTION
RISK OF ELECTRIC SHOCK
DO NOT OPEN



CAUTION: TO REDUCE THE RISK OF ELECTRIC SHOCK, DO NOT REMOVE COVER (OR BACK). NO USER-SERVICEABLE PARTS INSIDE. REFER SERVICING TO QUALIFIED SERVICE PERSONNEL.



The lightning flash with arrowhead symbol, within an equilateral triangle, is intended to alert the user to the presence of uninsulated 'dangerous voltage' within the product's enclosure that may be of sufficient magnitude to constitute a risk of electric shock to persons.



The exclamation point within an equilateral triangle is intended to alert the user to the presence of important operating and maintenance (servicing) instructions in the literature accompanying the appliance.

WARNING: TO REDUCE THE RISK OF FIRE OR ELECTRIC SHOCK, DO NOT EXPOSE THIS APPLIANCE TO RAIN OR MOISTURE.

Terminology

Since they share some of the characteristics and technology of CD players, many of the terms and operational concepts used in a DVD player are similar to what you may be familiar with from CD players and changers, or older video disc formats such as Laser Disc. However, if this is your first DVD product, some of the terms used to describe the features of a DVD player may be unfamiliar. The following explanations should solve some of the mysteries of DVD, and help you to enjoy all the power and flexibility of the DVD format and the DVD.

With the arrival of DVD, disc data capacity has increased dramatically. On a DVD Video disc most of this capacity is taken up by MPEG 2 video and the multichannel movie soundtrack in Dolby Digital and/or DTS. This information is compressed. But with DVD Audio, most of this capacity is available for music only, without any compression. This allows us to put the audio information on the disc in the same quality as the original mastering in the studio, in PCM up to 24 bit/192 kHz.

DVD-Audio's 24-bit system provides substantially improved resolution of fine detail, because it describes a specific point in the musical information using a 24-digit long string of one's and zero's with 16,777,216 possible combinations, while CD's primitive 16-bit system offers only 65,536 options. The 192 kHz frequency allows us to have fast changes in music made audible, which results in more dynamism, and also allows us to obtain a higher bandwidth, up to 96 kHz. Although that is far beyond the human audible spectrum, it still improves the musical realism.

Aspect Ratio: This is a description of the width of a video image in relation to its height. A conventional video screen is four units wide for every three units of height, that's why the ratio is called "4:3". Newer wide aspect ratio video displays are 16 units wide for every nine units of height, making them more like the screen in a movie theater. The program material on a DVD may be recorded in either format and, in addition, you may configure the DVD to play back in either format, depending on the features recorded on a disc.

Title: For a DVD, a title is defined as an entire movie or program. There can be as many chapters within a title as the producers decide to include. Most discs include only one title, but some may have more than one, to give you a "Double Feature" presentation.

Chapter: DVD programs are divided into chapters and titles. Chapters are the sub-sections programmed into a single title on a disc. Chapters may be compared to the individual tracks on an audio CD.

RGB Video: This is a new form of video signal that eliminates many of the artifacts of traditional composite video signals by splitting the signal into the three fundamental colors Red, Green and Blue (RGB). With an RGB connection (via SCART), you will see greater picture resolution and eliminate many picture imperfections such as the moiré patterns often seen on checkered patterned cloths. However, in order to benefit from RGB video, you must have a video display with an RGB compatible SCART input.

Progressive scan: DVD offers progressive scan video outputs for use with compatible high-resolution televisions and projectors. Before DVD, no consumer medium could store, transmit or display video with full resolution. To conserve bandwidth, analog compression (interlacing) is employed: first the odd-numbered lines of a frame are displayed, followed by the even-numbered lines. The result is that only half of the video image is drawn at one time; the viewer's brain must reassemble the complete image. This is acceptable, if the monitor is not too large and if there is not too much motion in the image. Large displays and fast-moving images reveal the limitations of this system. Thanks to DVD's immense data capacity, images are now stored intact (progressively), so that all the lines in each frame (odd and even) are shown at the same time. But because most TV's cannot handle a progressive signal, all current DVD players generate an interlaced output for compatibility. Now, the Harman Kardon DVD is among the select few DVD players with true progressive scan video output (NTSC and PAL) for use with compatible TV's and CRT projectors and with all plasma, LCD and DLP display devices via the component video output. The result is 40% greater light output than a conventional TV and a stunningly detailed high definition image, along with an almost complete absence of visible scanlines and motion artifacts. Of course, traditional Y/Pr/Pb component video, SCART, S-Video and composite video outputs are included for use with conventional televisions and projectors.

Multiple Angle: DVDs have the capability to show up to four different views of the same scene in a program. When a disc is encoded with multiple-angle information, pressing the Angle button will enable you to switch between these different views. Note that at present, few discs take advantage of this capability and, when they do, the multiple-angle technology may only be present for short periods of time within the disc. Producers will usually insert some sort of icon or graphic in the picture to alert you to the availability of multiple viewing angles.

Reading: This is a message that you will see after you've loaded the disc and the tray has closed. It refers to the fact that the player must first examine the contents of the disc to see if it is a CD or DVD, and then extract the information about the type of material on the disc, such as languages, aspect ratios, subtitles, number of titles and more. The slight delay while the contents of the disc are read is normal.

Resume: The operation of the Stop Button on the DVD works differently from what you are used to on CD players. On a traditional CD player, when you press the Stop button, the unit does just that: it stops playback. On a CD player, when you press the start button again, the disc starts from the beginning. With the DVD, however, you have two options when playing DVD discs. Pressing Stop once will stop playback, but it actually puts the unit in the Resume mode. This means that you can turn the machine off and, when you press play the next time, the disc will resume or continue from the point on the disc where the Stop button was pressed. This is helpful if you are watching a movie and must interrupt your viewing session but wish to pick up where you left off. Pressing the Stop button twice will stop the machine in a traditional manner and, when the disc is played again, it will start from the beginning.

In resume mode, the cover of the DVD will be displayed, if available. Otherwise, the Harman Kardon screen will appear.

Front Panel Controls

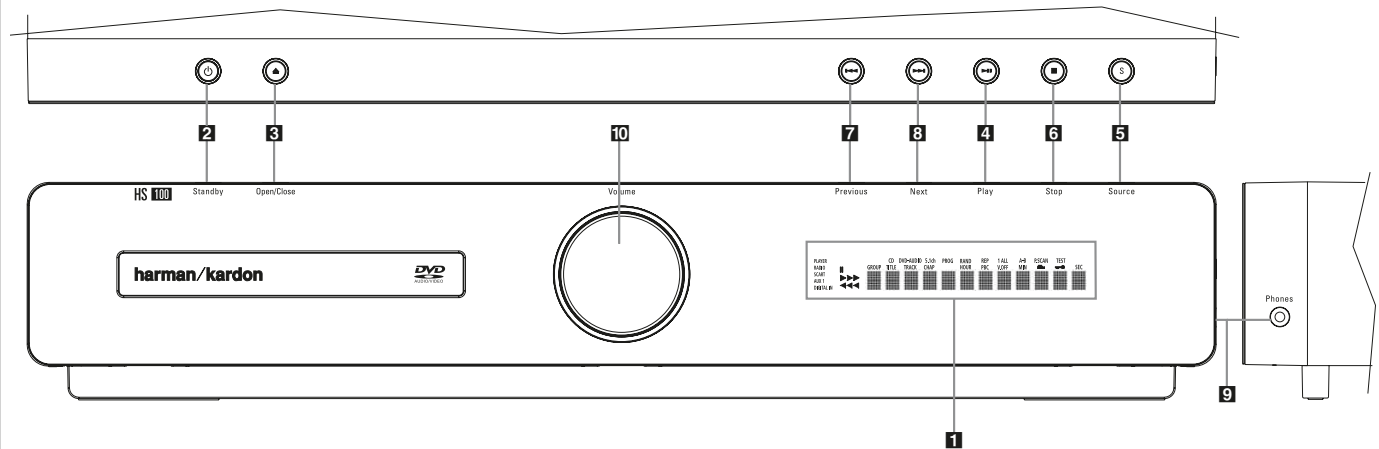

- | | | | |
|-----------------------------------|-----------------|--------------------------|--------------------------|
| 1 Main Information Display | 4 Play | 7 Skip (Previous) | 10 Volume Control |
| 2 Power On/Off (Standby) | 5 Source | 8 Skip (Next) | |
| 3 Open/Close | 6 Stop | 9 Headphone Jack | |

1 Main Information Display: This display delivers messages and status indications to help you operate the HS 100 Controller.

2 Power On/Off (Standby): Press the button once to turn the HS 100 Controller on, press it again to put the unit in the Standby mode. Note that when the HS 100 Controller is switched on, the Power Indicator around the button turns blue.

3 Open/Close: Press this button to open or close the Disc Tray.

4 Play: Press to initiate playback.

5 Source: Press this button repeatedly to scroll through the available audio and video sources.

6 Stop: Press this button once to place the disc in the Resume mode, which means that playback will stop, but as long as the tray is not opened or the disc changed, DVD playback will continue from the same point on the disc when the Play Button is pressed again. Resume will also work if the unit was turned off. To stop a disc and have play start from the beginning, press the button twice.

7 Skip (Previous): Press this button to move backward through the music tracks on a CD disc or the chapters on a DVD disc.

8 Skip (Next): Press to move forward through the music tracks on a CD or the chapters on a DVD disc.

9 Headphone Jack: This jack may be used to listen to the system's output through a pair of headphones. Be certain that the headphones have a standard 3.5 mm stereo phone plug. Note that the main room speakers will automatically be turned off when the headphone jack is in use.

10 Volume Control: Turn this knob clockwise to increase the volume, counterclockwise to decrease the volume. If the system is muted, adjusting volume control will automatically release the unit from the silenced condition.

Front Panel Display

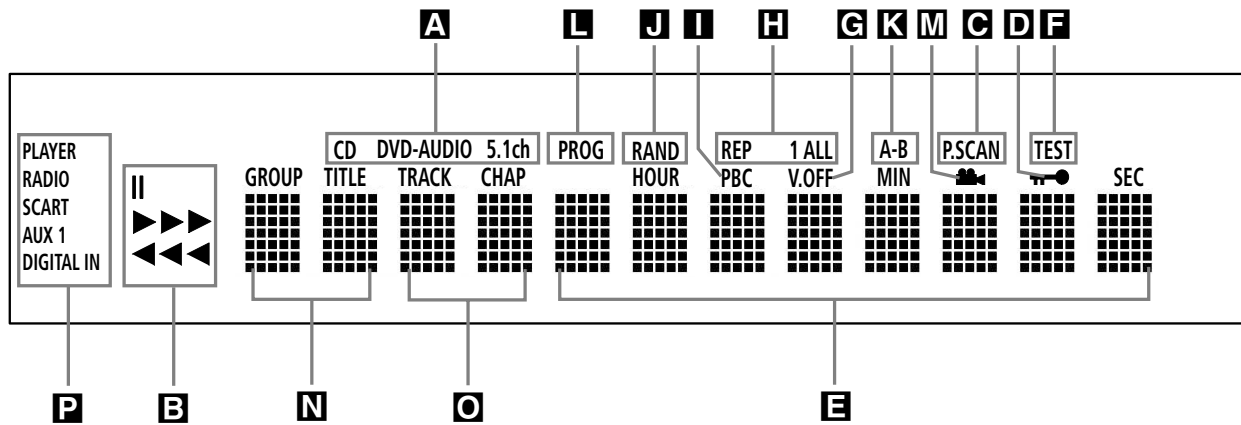

- A** Disc Type Indicators
- B** Playback-Mode Indicators
- C** Progressive Scan Indicator
- D** Parental Lock Indicator
- E** Time Indicators
- F** Test Indicator
- G** V-Off Indicator
- H** Repeat Indicators
- I** VCD Playback Control Indicator
- J** Random Indicator
- K** A-B Repeat Indicator
- L** Program Indicator
- M** Angle Indicator
- N** Title Indicators
- O** Chapter/Track Number Indicators
- P** Source Indicators

A Disc Type Indicators: The CD, DVD or DVD Audio indicator will illuminate to show the type of disc currently being played.

B Playback-Mode Indicators: These indicators light to show the current playback mode:

- ▶ Lights when a disc is playing in the normal mode
- ▶▶ Lights when the disc is in the Fast Search Forward mode. The on-screen banner display indicates the selected speed (2x, 8x, 16x, 100x).
- || Lights when the disc is paused.
- ◀◀ Lights when the disc is in the Fast Search Reverse mode. The on-screen banner display indicates the selected speed (2x, 8x, 16x, 100x).

C Progressive Scan Indicator: This indicator lights when the unit sends out a progressive scan signal.

D Parental Lock Indicator: This indicator lights when the parental-lock system is engaged in order to prevent anyone from changing the rating level without a code.

E Time Indicators: These positions in the indicator will show the running time of a DVD in play. When a CD is playing, these indicators will show the current track time, time remaining in the current track, or the total remaining time on the disc.

NOTE: The Indicators **NOE** will also display text messages about the DVD's status, including **Reading** when a disc is loading, **STANDBY** when the unit is turned off, and **Disc Error** when a disc not compatible with the DVD is put into the play position.

F Test Indicator: This indicator lights when the TV test screen is activated.

G V-OFF Indicator: This indicator lights when the unit's video output has been turned off by pressing the V-OFF button on the remote control.

H Repeat Indicators: These indicators light when any of the Repeat functions are in use.

I VCD Playback Control Indicator: This indicator lights when the playback control function is turned on with VCDs.

J Random Indicator: This indicator lights when the unit is in the Random Play mode.

K A-B Repeat Indicator: This indicator lights when a specific passage for repeat playback has been selected.

L Program Indicator: This indicator lights when the programming functions are in use.

M Angle Indicator: This indicator blinks when alternative viewing angles are available on the DVD currently playing.

N Title Indicators: These two positions in the display will show the current title number when a DVD disc is playing.

O Chapter/Track Number Indicators: When a DVD disc is playing, these two positions in the display will show the current chapter. When a CD disc is playing they will show the current track number.

P Source Indicators: These indicators will light to show which source is currently selected.

Rear Panel Connections

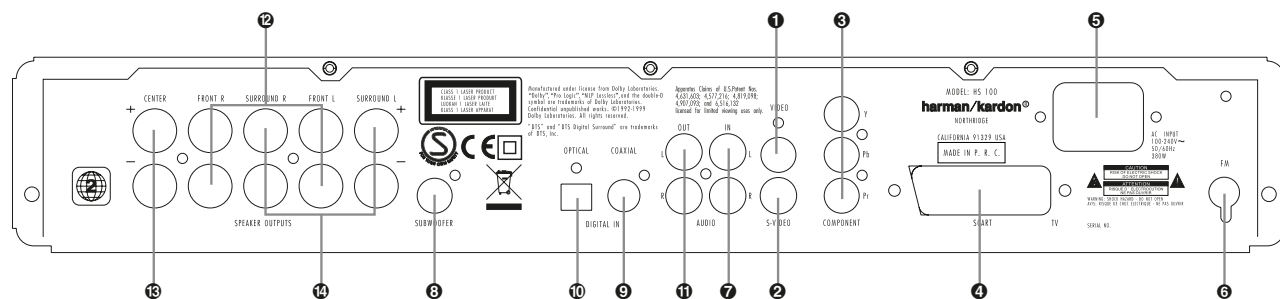

- 1 Composite Video Output
- 2 S-Video Output
- 3 Component Video Outputs
- 4 Scart TV Output
- 5 AC Power Cord
- 6 FM Antenna
- 7 Audio In
- 8 Subwoofer Output
- 9 Coaxial Digital Input
- 10 Optical Digital Input
- 11 Analog Audio Outputs
- 12 Front Speaker Outputs
- 13 Center Speaker Outputs
- 14 Surround Speaker Outputs

1 Composite Video Output: Connect this jack to the video input on a television or video projector.

2 S-Video Output: Connect this jack to the S-Video input on a television or video projector.

3 Component Video Outputs: These outputs carry the component video signals for connection to display monitors with component video inputs. For standard analog TV's or projectors with inputs marked Y/Pr/Pb or Y/Cr/Cb, connect these outputs to the corresponding inputs. If you have a high-definition television or projector that is compatible with high scan rate progressive video, connect these jacks to the "HD Component" inputs. Note that if you are using a progressive scan display device, then "Progressive" must be selected in the Video Set-up Menu in order to take advantage of the progressive scan circuitry. See page 16 for more information on progressive scan video.

IMPORTANT: These jacks should NOT be connected to standard composite video inputs.

4 SCART OUT (TV): If your TV has a SCART socket, you can connect a SCART cable to your TV and to your DVD Player for improved video quality. The SCART cable carries both audio and video. You can select Composite Video or RGB video for that SCART connector's video output signal.

5 AC Power Cord: Connect this plug to an AC outlet. If the outlet is controlled by a switch, make certain that it is in the ON position.

6 FM Antenna: Connect to the supplied FM antenna.

7 Audio In: Connect to a line-level analog audio source: TV, tape player, Minidisc, PC, etc.

8 Subwoofer Output: Connect to the SUB/LFE input on the subwoofer.

9 Coaxial Digital Input: Connect the coax digital output from a DVD player, HDTV receiver, LD player, MD player, satellite receiver or CD player to this jack. The signal may be either a Dolby Digital signal, DTS signal or a standard PCM digital source. Do not connect the RF digital output of an LD player to these jacks.

10 Optical Digital Input: Connect the optical digital output from a DVD player, HDTV receiver, LD player, MD player, satellite receiver or CD player to this jack. The signal may be either a Dolby Digital signal, DTS signal or a standard PCM digital source. Do not connect the RF digital output of an LD player to these jacks.

11 Analog Audio Outputs: Connect these jacks to the analog audio input on a TV set or external audio system for analog audio playback or to the RECORD/INPUT jacks of an audio recorder for recording.

12 Front Speaker Outputs: Connect these outputs to the matching + or – terminals on your left and right speakers. In conformance with the new CEA color code specification, the White terminal is the positive, or "+" terminal that should be connected to the red (+) terminal on Front Left speaker with the older color coding, while the Red terminal is the positive, or "+" terminal that should be connected to the red (+) terminal on Front Right speaker. Connect the black (–) terminals on the HS to the black (–) terminals on the speakers. See page 12 for more information on speaker polarity.

13 Center Speaker Outputs: Connect these outputs to the matching + and – terminals on your center channel speaker. In conformance with the new CEA color code specification, the Green Terminal is the positive, or "+" terminal that should be connected to the red (+) terminal on speakers with the older color coding. Connect the black (–) terminal on the HS to the black negative (–) terminal on your speaker. (See page 12 for more information on speaker polarity.)

14 Surround Speaker Outputs: Connect these outputs to the matching + and – terminals on your surround channel speakers. In conformance with the new CEA color code specification, the Blue terminal is the positive, or "+" terminal that should be connected to the red (+) terminal on the Surround Left speaker with older color coding, while the Gray terminal should be connected to the red (+) terminal on the Surround Right speaker with the older color coding. Connect the black (–) terminal on the HS to the matching black negative (–) terminals for each surround speaker. (See page 12 for more information on speaker polarity.)

Note: You'll find more details about all Audio/Video connections under Setup and Connections on the following pages.

Remote Control

- 1 Power On
- 2 Power Off
- 3 Subtitle
- 4 Title
- 5 Angle
- 6 Audio
- 7 Enter
- 8 Open/Close
- 9 OSD
- 10 Arrows
- 11 Mute
- 12 Menu
- 13 Pause
- 14 Status
- 15 Skip/Step (Previous)
- 16 Skip/Step (Next)
- 17 Play
- 18 Search/Slow Reverse
- 19 STOP
- 20 Search/Slow Forward
- 21 Display
- 22 Pic +/Pic -
- 23 Zoom
- 24 Playlist
- 25 Random
- 26 A-B Repeat
- 27 Volume (+ or -)
- 28 Player
- 29 Numeric Keys
- 30 Repeat
- 31 Clear
- 32 Radio
- 33 TV
- 34 AUX
- 35 Digital In

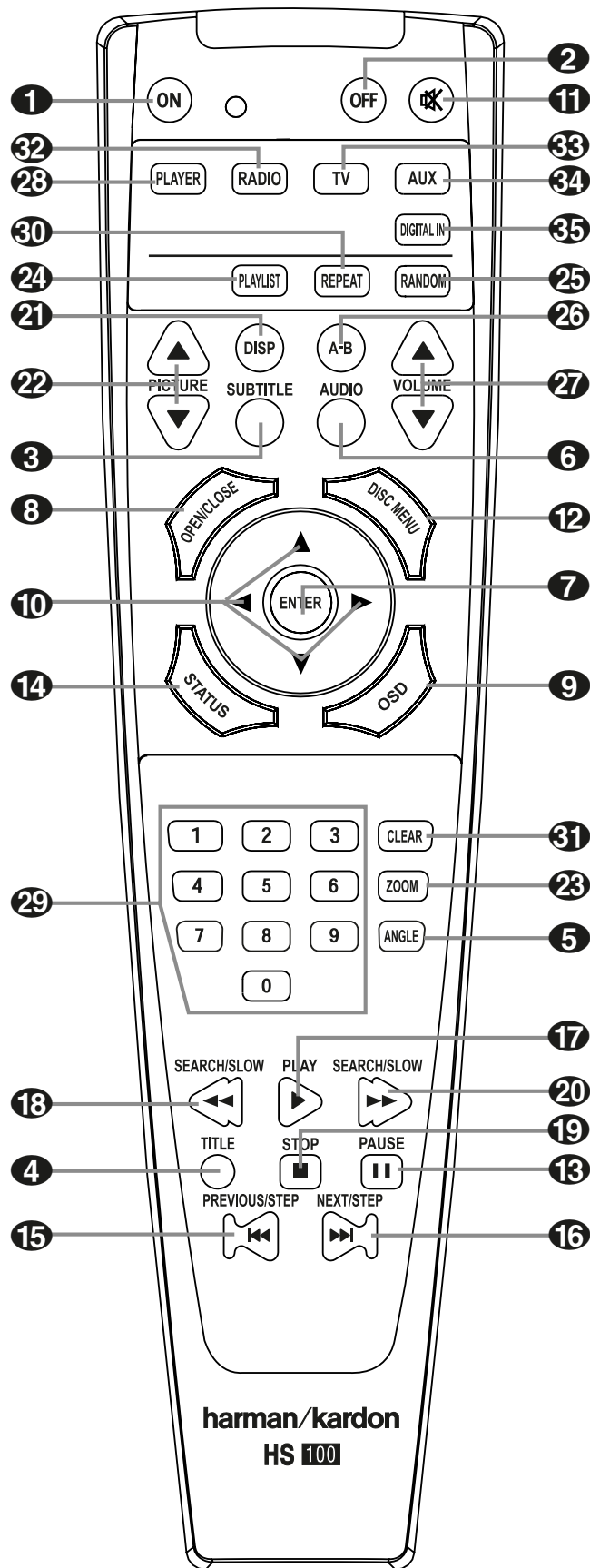

Remote Control

- 1 Power On:** Turns on the player when it is in standby mode (Harman Kardon logo appears on screen).
- 2 Power Off:** Turns off the player to standby mode.
- 3 Subtitle:** When a DVD is playing, press to select a subtitle language or to turn subtitles off.
- 4 Title:** When a disc is playing, press to make the player go back to the first section of the disc.
- 5 Angle:** Press to access various camera angles on a DVD (If the DVD contains multiple camera angles) or to rotate JPEG images.
- 6 Audio:** Press to access various audio languages on a DVD (If the DVD contains multiple audio streams).
- 7 Enter:** Press this button to activate a setting or option.
- 8 Open/Close:** Press to open or close the disc tray.
- 9 OSD:** Press to access the On Screen Display Menu.
- 10 Arrow buttons (◀/▶/▲/▼):** Use to move the cursor in the OSD.
- 11 Mute:** Mutes the sound.
- 12 Menu:** Displays the actual DVD Disc Menu on the TV screen in play mode. When playing discs with JPEG images, pressing this button will access the thumbnails.
- 13 Pause:** Freezes a picture (with DVD/VCD) and pauses the playback signal (CD) when a disc is playing. Press again for normal playback.
- 14 Status:** Press while a disc is playing to view banner display. Use the ARROW buttons to move through the different features in the Banner Display. When a symbol is highlighted, press ENTER on the remote to select it.
- 15 Skip/Step (Previous):** Press to go to beginning of current track. Press again quickly to go to beginning of previous track. After pressing the PAUSE button, each press of this button will move the image in reverse frame by frame.
- 16 Skip/Step (Next):** Press to go to beginning of next track. After pressing the PAUSE button, each press of this button will move the image forwards frame by frame.
- 17 Play:** Begins to play disc (closes disc tray first, if it is open).
- 18 Search/Slow (Rev.):** Allows you to search in reverse through a disc while it is in play mode. Each time you press this button, the search speed changes as indicated by a number of arrows on the right top of your screen. After pressing the PAUSE button, each press of this button will change the slow down speed indicated by a number of arrows in the right top of the screen.
- 19 Stop:** Stops playing a disc. When a disc is playing, if you press STOP and PLAY, the disc will resume play, i.e. it will start from the same point on the disc where the unit was stopped. If you press STOP twice and the PLAY button, the disc will start play from the beginning.
- 20 Search/Slow (Fwd.):** Allows you to search forward through a disc while it is in play mode. Each time you press this button, the search speed changes as indicated by a number of arrows on the right top of your screen. After pressing the PAUSE button, each press of this button will change the slow down speed as indicated by a number of arrows in the right top of the screen.
- 21 Display:** Press to change the brightness of the front panel display or to turn the display off completely in the following order: HALF BRIGHTNESS → OFF → FULL BRIGHTNESS → HALF BRIGHTNESS.
- 22 Pic +/Pic -:** Pressing these buttons in JPEG mode will move to the previous or next image.
- 23 Zoom:** When a DVD or VCD is playing, press this button to zoom the picture so that it is enlarged. There are 4 steps to the zoom function, each progressively larger. Press through each of the zoom stages to return to a normal picture.
- 24 Playlist:** Press this button to change the playback order of the disc.
- 25 Random:** Press for RANDOM playback in random order.
- 26 A-B:** Press to select section A-B and to play repeatedly.
- 27 Volume (+ or -):** Increase/decrease the master volume level.
- 28 Player:** Selects the internal CD/DVD drive as input source.
- 29 Numeric Keys:** Select numbers by pressing these buttons.
- 30 Repeat:** Press to go to the Repeat menu. You can repeat a chapter, track or the entire disc.
- 31 Clear:** Press to remove the Banner menu from the screen.
- 32 Radio:** Selects the internal FM radio as input source.
- 33 TV:** Selects the audio/video device connected to the SCART input as input source.
- 34 AUX:** Selects the audio device connected to the AUX input as input source.
- 35 Digital In:** Selects the audio device connected to the digital audio input as input source.

Basic Information

About This Manual

- The types of functions and operations that can be used for a particular disc vary depending on the features of that disc. In some cases, these functions and operations may differ from the descriptions given in this manual. In this event, follow the instructions given on the screen. This manual only covers basic disc operations.
- For some operations, the  icon may appear on the screen. This indicates that the operation described in this manual is not available on the disc in the player.
- On-screen and front panel display illustrations in this manual are purely for the purposes of explanation. The actual displays may differ slightly from these illustrations.

Disc handling precautions

- To keep the disc clean, handle the disc by its edge. Do not touch the surface.
- Do not stick paper or tape on the disc. If there is glue (or a similar substance) on the disc, remove the glue completely before using the disc.

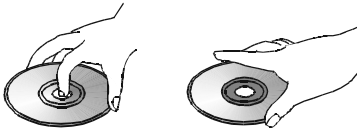

- Do not expose the disc to direct sunlight or sources such as hot air ducts, or leave it in a car parked in direct sunlight as there can be a considerable rise in temperature inside the car.
- After playing, store the disc in its case.
- Do not write on the label side with a ball-point pen or other writing utensils.
- Be careful not to drop or bend the disc.

Disc cleaning precautions

- Before playing, clean the disc with a cleaning cloth. Wipe the disc from the center out.
- Do not use solvents such as benzine, thinner, commercially available cleaners or anti-static spray intended for vinyl LPs.

Disc installing precautions

- Do not install more than 1 disc on disc tray.
- Do not place the disc on the tray up-side down.
- Do not try to close the disc tray when the disc is not installed and centered properly.

Regional Coding

DVD players and discs are designed with regional restrictions which dictate the regions in which a disc can be played. If the region number on the disc you want to play does not match the region number of your DVD player, you will not be able to play the disc. The message "REGION ERR" will appear in the front panel display. The region code of this player is indicated on the rear and on the external packaging.

Installation and Connections

After unpacking the unit, and placing it on a solid surface capable of supporting its weight, you will need to make the connections to your audio and video equipment.

Audio Equipment Connections

We recommend that you use high-quality interconnect cables when making connections to source equipment and recorders to preserve the integrity of the signals.

When making connections to audio source equipment or speakers it is always a good practice to unplug the unit from the AC wall outlet. This prevents any possibility of accidentally sending audio or transient signals to the speakers that may damage them.

1. Connect the front, center and surround speaker outputs **12** **13** **14** to the respective speakers.

Cables that are run inside walls should have the appropriate markings to indicate listing with any appropriate testing agency standards. Questions about running cables inside walls should be referred to your installer or a licensed electrician who is familiar with the applicable local building codes in your area.

When connecting wires to the speakers, be certain to observe proper polarity. Note that the positive (+) terminal of each speaker connection now carries a specific color code as noted on page 8. However, most speakers will still use a red terminal for the positive (+) connection. Connect the "negative" or "black" wire to the same terminal on both the receiver and the speaker.

We also recommend that the length of cable used to connect speaker pairs be identical. For example, use the same length piece of cable to connect the front-left and front-right or surround-left and surround-right speakers, even if the speakers are a different distance from the HS controller.

2. Connections to the subwoofer are made via a line level audio connection from the **Subwoofer Output 8** to the line-level SUB input (purple) of the subwoofer.

3. Connect the supplied FM antenna to the **FM (75 ohm)** connection **6**. The FM antenna may be an external roof antenna, an inside powered or wire lead antenna or a connection from a cable system. Note that if the antenna or connection uses 300-ohm twin-lead cable, you should use a 300-ohm-to-75-ohm adapter to make the connection.

Video Equipment Connections

Video equipment is connected in the same manner as audio components. Again, the use of high-quality interconnect cables is recommended to preserve signal quality.

Connecting the TV and optional components

NOTE: To be able to listen to the sound of a live TV show through the loudspeakers of your HS system you need a connection between the audio output of your TV and the HS controller: to achieve this when using the supplied SCART cable, you don't need to connect any additional wires – the SCART cable transports audio and video signals in both directions. But when using the S-Video or composite jacks you need to connect the audio output of your TV set with the AUDIO IN jack **7** on the back of your HS controller.

TV Connection (method 1) – using SCART cable (included)

To view the video from DVD discs on your TV set, connect the SCART TV Out jack **4** of the HS system to the SCART In jack of your TV set. The audio connection runs through the same cable (see note above).

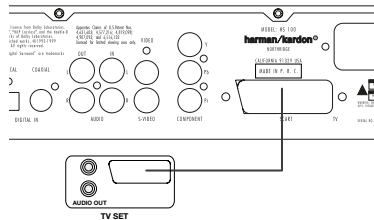

TV Connection (method 2) – using S-Video cable (not included)

If your TV set has an S-Video input jack you can connect your TV to the S-Video out jack **2** on the back of the HS controller. S-Video wires don't transport audio signals, thus you need an additional audio connection (see note above).

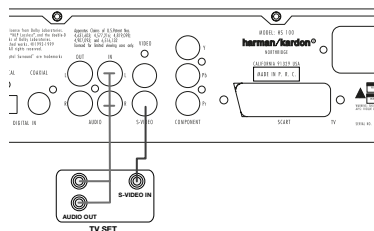

TV connection (method 3) – using composite video (cable not included)

If your TV set has neither S-Video nor SCART input jacks, connect the Video Out jack **1** of the HS to the Video In jack of your TV set. The composite wire also doesn't transport audio signals, thus you need to make additional connections (see earlier note).

Component Video Connection (method 4)

If the video display has component video inputs, connect the Component Video Outputs **3** on the DVD to the corresponding input jacks on your

television. If you are using a progressive scan television or projector, you must also change the Scan Type in the DVD player's Video Set-Up Menu from "Interlaced" to "Progressive".

Connecting VCR and Sat Decoder (method 5 and 6)

Diagrams 5 and 6 show possible connection methods for common system configurations. These are intended as guidelines only. Due to differences in equipment specifications, the method of connection of your equipment may be different to that shown. Please consult the Owner's Manual of your equipment for further guidance.

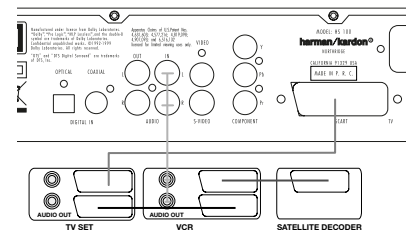
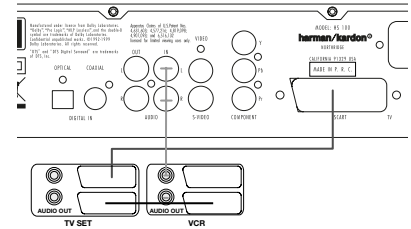

Connecting Set-top Box or Digital Satellite Receiver (method 7) - using coaxial digital cable

To listen to the digital multichannel downmix from Set-top boxes or digital satellite receivers, connect the Coaxial Digital Out **9** of your device to the Coaxial Digital In on the HS controller.

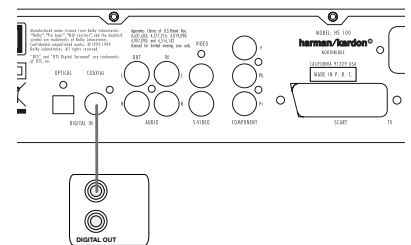

Optional Audio Connections

Aux Input for External Source

You may connect a line-level stereo analog audio source such as a Sat receiver, tape deck, phono preamp of a record player, etc. to the controller's rear panel AUDIO IN Input **7** sockets to enjoy the benefits of your HS system with other source components.

- VCR Connection-Audio (Cables Not Included). To listen to the sound from your stereo VCR through the speakers of this system, connect

Installation and Connections

the Left/Right audio output jacks of your stereo VCR to the Left/Right audio input jacks AUDIO IN 7 of this system.

- **Audio Out Connections.** To record the sound of the HS system with your VCR or any audio recording device (tape deck, MD, CDR and some others,) the Audio Out jacks 11 should be connected to the analog Record In jacks of the appropriate device. They can also be connected to any audio input on your TV to listen to the sound of your HS controller through the speakers of your TV only, when the amp in your subwoofer is turned off and the volume of the HS controller has been turned down completely. If the speakers of your HS system are active, the volume on your TV should be turned down.

Connect the digital output of any digital sources such as an optional CD or DVD changer or player, advanced video game, a digital satellite receiver, HDTV tuner or digital cable set-top box or the output of a compatible computer sound card to the **Optical** and **Coaxial Digital Inputs** 9 10.

Speaker Placement

The placement of speakers in a multichannel home-theater system can have a noticeable impact on the quality of sound reproduced.

Depending on your viewing device, place the center speaker either directly above or below your TV, or in the center behind a perforated front-projection screen.

Once the center-channel speaker is installed, position the left-front and right-front speakers so that they are as far away from one another as the center-channel speaker is from the preferred listening position. Ideally, the front-channel speakers should be placed so that their tweeters are no more than 60cm above or below the tweeter in the center-channel speaker.

Depending on the specifics of your room acoustics, you may find that imaging is improved by moving the front-left and front-right speakers slightly forward of the center-channel speaker. If possible, adjust all front loudspeakers so that they are aimed at ear height when you are seated in the listening position.

Using these guidelines, you'll find that it takes some experimentation to find the correct location for the front speakers in your particular installation. Don't be afraid to move things around until the system sounds correct. Optimize your speakers so that audio transitions across the front of the room sound smooth.

When the HS is used in 5.1-channel operation, the preferred location for surround speakers is on the side walls of the room, at or slightly behind the listening position.

Rear surround speakers may also be used in 5.1 channel mode as an alternative mounting position when it is not practical to place the main surround speakers at the sides of the room. Speakers may be placed on a rear wall, behind

the listening position. As with the side speakers, the center of the rear surrounds should face you. The speakers should be no more than 2 meters behind the rear of the seating area.

Subwoofers produce largely nondirectional sound, so they may be placed almost anywhere in a room. Actual placement should be based on room size. One method of finding the optimal location for a subwoofer is to begin by placing it in the front of the room, about 15cm from a wall, or near the front corner of the room. Another method is to temporarily place the subwoofer in the spot where you will normally sit, and then walk around the room until you find a spot where the subwoofer sounds best. Place the subwoofer in that spot.

Connecting the AC Power

Notes

- The Power Requirement is: AC 230V, 50 Hz.
- Connecting to power other than the one listed above may damage the system or cause abnormal operation.
- Before connecting the AC power cord of this system to a wall outlet, connect the speakers and other component cables to the system.
- Connect the AC power cord of the active subwoofer.
- Connect the AC power cords of your TV and any optional components to a wall outlet.

Once the speakers have been placed in the room and connected, the remaining steps are to program the system configuration memories.

First Turn On

You are now ready to power up the HS 100 Controller to begin final adjustments.

1. Plug the **Power Cable** 5 into an unswitched AC outlet. Note that the **Power Indicator** 2 will turn orange, indicating that the unit is in the Standby mode.
2. Remove the protective plastic film from the main front-panel lens. If left in place, the film may affect the performance of your remote control.
3. Install the three supplied AAA batteries in the remote as shown. Be certain to follow the (+) and (-) polarity indicators that are on the top of the battery compartment.

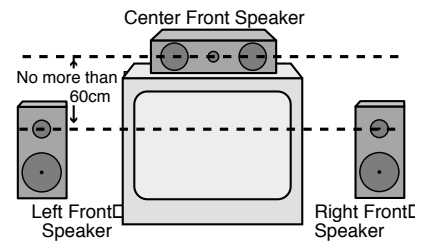
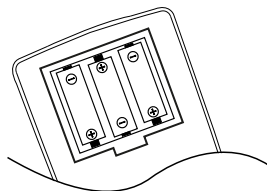

A) Front Channel Speaker Installation with Direct-View TV Sets or Rear-Screen Projectors

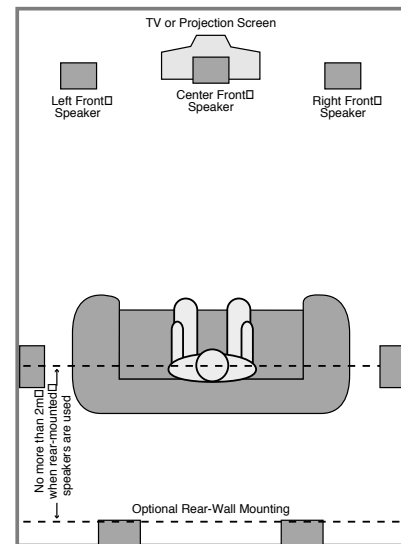

B) The distance between the left and right speakers should be equal to the distance from the seating position to the viewing screen. You may also experiment with placing the left and right speakers slightly forward of the center speaker. Rear speaker mounting is an alternate location for 5.1 systems.

4. Turn the HS 100 on either by pressing the **Power On/Off** 2 or the **Input Source Selector** 5 on the front panel, or via the remote by pressing the **Power On Button** 1 on the remote. The **Power Indicator** 2 will turn blue to confirm that the unit is on, and the **Main Information Display** 1 will also light up.

Basic Play

Preparation

1. Switch the TV ON and select its video input connected to the HS Controller.
2. When you switch on the HS system controller, a Harman Kardon HS welcome image should appear on the screen. If that screen appears distorted or without color, change the appropriate settings at the Video Setting Sub-menu according to your TV set and to the connection used between the HS Controller and your TV.
3. If there is no picture at all, not even the Harman Kardon screen, check the setting of the video input used on your TV (most SCART inputs on TVs can be configured in the TV's menu). If this doesn't work, connect your TV with different cables to the HS Controller, e.g. via Composite (yellow jacks) or S-Video cables, rather than SCART to view the setup menus until all appropriate "Video menu" settings are made properly.
4. Press OPEN/CLOSE **3 8** to open the disc tray.
5. Place a disc on the disc tray.
Hold the disc without touching either of its surfaces, position it with the side you wish to play facing down, align it with the guides, and place it in its proper position.
 - 3" (8 cm) discs or 5" (12 cm) discs can be used.
6. Press PLAY **4 17**. The disc tray is automatically closed and play begins.
 - When the disc tray is closed by pressing OPEN/CLOSE **3 8**, play will start automatically.
 - With most DVD's, a Disc Menu appears on the screen. Select specific menu item by using ARROW **10** buttons on the remote, then press ENTER **7**.

Disc Playback Features

Skipping tracks or titles/chapters

To move forward or backward through the tracks on a CD or the titles or chapters on a DVD, press Previous/Next **7 8 15 16**.

Fast Motion Playback/Fast Search

1. To move forward or backward through the DVD or CD disc being played at fast speed, press Search **18 20** on the remote. Once one of these buttons is pressed, the fast search will continue until Play is pressed.

There are four fast-play speeds. Each press of the Search Buttons will cycle to the next speed in the following order: 2x, 4x, 16x, 100x, indicated by a number of arrow indicators on the right top of the screen.

2. Press PLAY **4 17** at any time to resume normal playback.

Note that there will be no audio playback during fast-forward or -reverse play of DVD discs. This is normal for DVD, as surround processors cannot process the digital audio streams during fast-play modes; audio will be heard during fast-play of conventional CD's.

Freeze Frame and Frame Advance (with DVD only)

1. Press PAUSE **4 13** when a DVD is playing to freeze the picture.
2. Each time you press one of the STEP (FWD or REV **15 16**) buttons, the picture advances one frame in the selected direction.
3. Press PLAY **4 17** to resume normal playback.

Slow Motion Playback (with DVD only)

1. When a DVD disc is in pause or freeze frame mode, you may move slowly forward or backward through the program being played at one of four speeds by pressing the SEARCH Buttons **18 20** on the remote. Each press of the buttons will move to the next speed, indicated by a number of arrow indicators on the right top of the screen.
2. Press PLAY **4 17** to resume normal playback.

Note that there will be no audio playback during slow-forward or -reverse play of DVD discs. This is normal for DVD, as surround processors cannot process the digital audio streams during slow modes. Slow play is not available for CD.

Notes: Playback features may not be available during the opening credits of a movie. This is intended by the disc author and is not a failure of the HS Controller.

Playback of a DVD with 96 kHz/24-bit audio requires the use of circuitry normally used for other features. Accordingly, Slow Play Reverse and Step Advance features are not available with these discs.

Depending on the structure of a VCD disc, the functions Slow Reverse and Step Reverse may be prohibited or have no function and Fast Playback (Search) may not function.

Surround Mode

One of the most important features of the HS 100 Controller is its ability to reproduce a full multichannel surround sound field from digital sources, analog matrix surround encoded programs and standard stereo programs.

Selection of a surround mode is based on personal taste, as well as the type of program source material being used. For example, motion pictures, CD's or TV programs bearing the logo of one of the major surround encoding processes, such as Dolby Surround should be played in either the Dolby Pro Logic II Movie (with movies) or Music (with music) surround mode.

Surround modes and audio formats are selected using the remote. Press the AUDIO button **6** to toggle between the surround modes/audio formats available on the DVD disc. As you press the button, the Surround mode/audio format name will appear on your video display.

When a digital source is present, the HS Controller will automatically select and switch to the correct mode (Dolby Digital or DTS), regardless of the mode that has been previously selected.

To listen to a DVD-program in traditional two channel stereo, using the front left and front right speakers only (plus the subwoofer if installed and configured), follow the instructions shown in the chapter DVD Sound Mode, in the Audio Settings Menu.

System Setup

System Defaults

The final step of the installation is to establish the system's defaults. It is helpful to take a few minutes to familiarize yourself with these settings, as they may require change before the first use and later from time to time.

General Functionality of the OSD Menu

The complete setup and control of the HS 100 takes place in an advanced user-guided On Screen Display (OSD) menu system. The OSD can be activated by pressing the OSD button **9** on the remote control. Pressing this button again de-activates the OSD.

The main menu consists of a PLAYER Menu, RADIO Menu, TV Menu, AUX Menu, DIGITAL Menu and a SET-UP Menu. The PLAYER Menu will show all information and options available for the disc currently playing. The RADIO Menu will show radio and RDS options. The TV, AUX and DIGITAL Menus show the surround options for these specific audio inputs. The SET-UP Menu will help you configure all audio and video settings which are normally only made once.

Each Main Menu contains Submenus. These submenus are shown as icons on the left side of the menu. They can be highlighted by a white square around the icon by moving the cursor with the ARROW **10** buttons. Icons can be activated by pressing ENTER **7** when an icon is highlighted. When ENTER **7** has been pressed, the color of the icon will change to dark blue and you will see that the current settings of this submenu will appear on the right side of the menu. Although each Menu has various Submenus and Settings, they are all navigated in the same way. All submenus, settings and options can be accessed with the help of the ARROW (**▲▼◀▶** **10**) and ENTER **7** buttons on the remote control.

To change a setting, simply move the cursor to the setting you wish to change. This setting will be highlighted in light blue, and a brief explanation will appear in the Upper Menu Line on the bottom of your screen, together with the available options for this setting on the Lower Menu Line. Move the ARROW **◀/▶** **10** buttons to the requested option for this setting. Press ENTER **7** to activate the new setting.

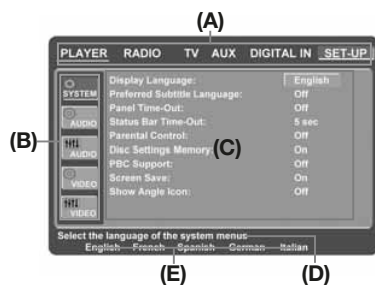

(A) Main Menu Line
(B) Submenus

- (C) Current Settings
- (D) Upper Menu Line with Brief Explanation
- (E) Lower Menu Line with Possible Options

Set Up Menu

The first step in checking or changing the system defaults is to access the Setup Menu. First, make certain that the HS Controller is properly connected to a video display, and that power is connected. For this process, however, you do not need to load a disc into the unit.

During STOP, PAUSE or PLAY mode, if you press OSD on the remote, the Main Menu appears on the screen.

This Main Menu and all menus in the following section may look different, listing the settings with different languages, depending on the settings made previously. With the factory default setting all languages are set to "English", that's why with all menus the English version is shown in the manual.

In the SET-UP Menu you will find submenus for making or changing all settings and adjustments for both Audio and Video handling of your HS 100.

To access the SET-UP Menu, press the OSD button **9**, and move the cursor to the right until SET-UP is highlighted. Press ENTER **7** to activate the SYSTEM Settings:

System Settings

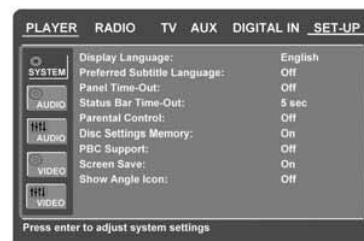

The System Setting Submenu contains the following settings. Follow the explanations in the Upper Menu Line on the bottom of your screen to change the settings.

Display Language: Sets the language in which the OSD menus are shown on your screen.

Preferred Subtitle Language: Defines your preferred subtitle language. Every time a disc contains this subtitle language, it will be shown automatically. If you do not find your preferred language in the list of options, you can select your preferred language by typing a 4-digit code found in the code list on page 21. You can also set the preferred subtitle language to OFF. In that case no subtitles will be shown.

Panel Time-Out: Sets the time-out interval for the Front Panel Information Display. After the selected time, the display will dim completely.

Status Bar Time-Out: Sets the time-out interval for the Status Bar, after which the Status Bar will disappear from the screen.

Parental Control: Defines a password used to control viewing of restricted programs. The default password is 8888. After pressing the default password, either the parental control setting can be chosen, or a new password. The five standard US rating symbols are "G" (General, level 1), "PG" (Parental Guidance, level 3), "PG13" (Parental Guidance and 13 years old, level 4), "R" (Restricted, level 6) and "NC 17" (from 17 years old, level 7). The DVD will accommodate a total of eight rating steps, as set by the DVD creators. These additional steps allow for more critical control of program playback for all audiences. Level 8: All DVDs can be played. Levels 7 to 2: DVDs for general audiences/children can be played. Level 1: DVDs for children can be played; DVDs for adults/general audiences are prohibited. Follow the explanations on the screen to set a new password.

Disc Setting Memory: When set to on, the next time a disc is inserted, I will show a "Disc Recognized" message, with the question if you would like to play the disc from the beginning or would like to resume from where you last stopped the disc. The memory can contain information of the last 100 discs played.

PBC Support: Activates PBC (Play Back Control) Support for VCD discs.

Screen Save: Activates a Screen Saver to prevent image "burn" in a video display device. If you connect the HS Controller to a LCD or plasma screen or video projector, we recommend you activate the screen saver at all times.

Show Angle Icon: Determines whether the Angle Icon will appear on the screen when there are different angles available on a DVD disc.

Audio Settings



The Audio Setting Submenu contains the following settings. Follow the explanations in the Upper Menu Line on the bottom of your screen to change the settings.

Preferred Audio Language: Defines your preferred audio language. Every time a disc is played that contains this audio language, it will be activated automatically. If you do not find your preferred language in the list of options, you can select your preferred language by typing a 4-digit code found in the code list on page 21.

System Setup

Dynamic Range: This setting enables Dolby Digital recordings to be played back with full dialogue intelligibility while reducing peak levels. This smooth level compression prevents abrupt loud transitions from disturbing others without reducing the impact of the digital source perceptibly.

Delay Unit: This setting sets the measuring unit for Delay in either Feet or Meter.

Tone Control: Activates or De-activates the Bass and Treble settings. Once either the Bass or Treble Settings are changed, the Tone Control automatically switches to ON.

Bass Level: Sets the level of low frequencies.

Treble Level: Sets the level of high frequencies.

DVD Sound Mode: Sets the audio format of the DVD-disc playing (for other sources, see Surround Mode in each respective chapter). Once set to stereo, every surround format on a DVD will be converted to a pure stereo signal. Once set to DPLII, all stereo signals on a DVD are forced into 5.1., leaving all multichannel signals in their original format. This setting is recommended. Original will follow the surround format on the disc.

Audio Adjustment

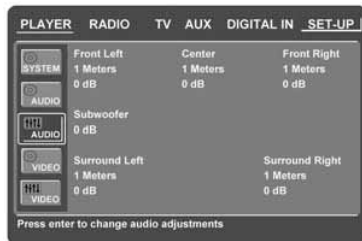

The Audio Adjustment Submenu contains the access to the speaker delay and the output level adjustment settings of the HS 100. Follow the explanations in the Upper Menu Line on the bottom of your screen to make adjustments.

Delay

Due to the different distances between the listening position for the front channel speakers and the surround speakers, the amount of time it takes for sound to reach your ears from the front or surround speakers is different. You may compensate for this difference through the use of the delay settings to adjust the timing for the specific speaker placement and acoustic conditions in your listening room or home theater. Measure the distance from the listening position to each of the individual loudspeakers. Once done, select per loudspeaker the distance that is closest to the one measured.

Output level adjustment

Output level adjustment is a key part of the configuration process for any surround sound product.

NOTE: Listeners are often confused about the operation of the surround channels. While some assume that sound should always be coming

from each speaker, most of the time there will be little or no sound in the surround channels. This is because they are only used when a movie director or sound mixer specifically places sound there to create ambiance, a special effect or to continue action from the front of the room to the rear. When the output levels are properly set it is normal for surround speakers to operate only occasionally. Artificially increasing the volume to the rear speakers may destroy the illusion of an enveloping sound field that duplicates the way you hear sound in a movie theater or concert hall.

The default settings of the DVD player is 0 dB for all channels. In case you feel adjustments are necessary in your setup, we advise you to make the adjustments using a test disc containing either pink noise or tracks that you are very familiar with.

Video Settings

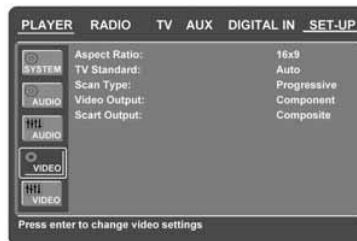

The Video Setting Submenu contains the following settings. Follow the explanations in the Upper Menu Line on the bottom of your screen to change the settings.

Aspect Ratio: This step selects the TV aspect ratio, conventional screen shape (4:3) or widescreen (16:9), according to your TV.

TV Standard: Sets the output video format i.e. NTSC or PAL, of the HS Controller. If you have a multi standard TV, we recommend the AUTO setting for optimal picture quality.

Scan Type: Sets the component video output to Interlace or Progressive. Before changing the setting to Progressive, make sure that your video display connected to the component output is capable of handling progressive scan signals. As soon as you select progressive scan the scan type, the Video Output will automatically change to Component. All other outputs, composite video on cinch, SCART and S-Video, will be kept Interlaced. The interlaced composite and S-Video outputs remain active for connection to a second (interlaced) video display.

Video Output: Sets the video output type to Scart or Component. Scart will be used for most TV's. Component will be used for most LCD, Plasma and projectors.

Scart Output: Selects which kind of video output signals will be routed over the scart. RGB will be used for most TV's as it provides the best picture quality.

Video Adjustment



The Video Adjustment Submenu contains the Test Screen. First adjust the video display device (TV) with the help of the Test Screen. After that the output settings of the player can be fine-tuned with the Color, Contrast, Brightness, Tint (NTSC and interlaced outputs only) and Black Level (NTSC and interlaced outputs only) settings. In order to change the settings, move the cursor to the "+" or "-" icon on the same line as the setting. Once one of the icons is highlighted, pressing ENTER (7) will increase or decrease the value of the setting, as will be shown in the bar behind the setting. To exit the Video Adjustment Menu, move the cursor to DONE, and press ENTER (7).

Test Screen

Test Screen

When you activate the Test Screen via the OSD you can activate a still image to test all settings and the video performance of your TV. With the vertical color bars you can test the following:

- proper color intensity on your TV,
- the proper color of each bar, showing if the proper video standard is turned on: the colors should be (left to right): black, white, yellow, cyan (turquoise), green, magenta (purple), red, blue, black.
- proper color transition, seen as sharp separation of the bars, S-Video will be better than Video, RGB best of all.
- the performance of the color filter in your TV (with "Video" signals), bar edges should show no vertical crawling dots. Here S-Video and RGB formats usually give no problems.

With the gray scale and the black/white fields below the color bars the brightness and contrast of your screen can be adjusted optimally, see "TV Picture Adjustment" below.

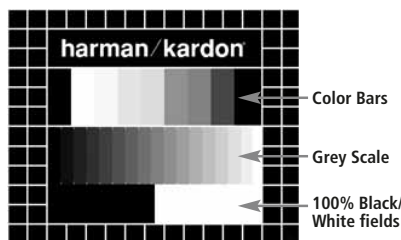

TV Picture Adjustment with Test Screen

These adjustments may be done now, but you can also make them after setup has been finalized.

Brightness adjustment:

1. Turn down the color control on your TV until the color bars are visible in black and white.
2. Adjust the contrast to the lowest level where you still can see all bars within the grey scale in the test picture separately and clearly.
3. Adjust the Brightness so that the bars in the gray scale are all visible. The bar furthest to the left has to be as black as possible rather than gray but the next must be clearly distinguishable. All the bars in the gray scale have to be gradually and evenly changing from black to whiter, from left to right.

Contrast adjustment:

1. Adjust the contrast on your TV until you see a bright white bar in the lower right corner of the screen and a deep dark black bar at the left. The optimal contrast setting will depend on your preference and the surrounding light in the TV room.
2. If the brightness of the white bar does not increase while turning up the contrast or when the borders of the white letters on top bloom (overlight) into the black areas, drastically decreasing the sharpness of the script, then the Contrast has been turned up too much. Reduce the contrast until these effects disappear and the video still looks realistic.
3. If you are watching TV in daylight, adjust the Contrast so that a normal video picture has about the same look as the surroundings in your room. This relaxes the eye when watching the TV picture. This contrast setting may be reduced when the surrounding light is dimmed, usually improving sharpness.
4. The gray scale in the middle line needs to have the same clear difference between each bar as before the contrast adjustment. If not, go back to the brightness adjustment and repeat step 3 and then the contrast adjustments, making only minor adjustments each time for optimisation.

Color adjustment.

1. When Brightness and Contrast are set optimally, turn up the color control. Adjust to the level where the colors look strong but still natural, not overdone. If the color level is too high, depending on the TV used some of the bars will seem wider or the color intensity will not increase when the control is turned up. Then the color control must be reduced again. At the end you should test the color intensity also with a video, e.g. pictures of natural faces, flowers, fruit and vegetables and other well known natural articles for an optimal setting of the color intensity.
2. If your TV has a Tint option (with most European TVs this is available or effective only with NTSC signals, not with PAL), use the large white bar below the Grayscale to tweak the warmth of the picture. Every viewer has a difference in preference. Some prefer a little colder picture, some a warmer glow. The Tint function on your TV and the white bar can be used to control this. Adjust the Tint to the level where you feel the white color has the tone you prefer.

Player/Radio Menu

Using the Status Bar Menu

The on-screen Status Bar contains many playback features. To see the Status Banner Menu, press STATUS **14** on the remote control while a disc is playing. Use the ARROW **10** buttons on the remote to move through the different features in the Status Bar. When a feature is highlighted, press ENTER **7** on the remote to select it and to change it with the help of the options listed on the screen. Press ENTER **7** to activate the change.

Title: The number shown indicates the number of the title that is currently playing.

Chapter: The number shown indicates the number of the chapter that is currently playing on a disc.

Time: This item displays the time in DVD mode. To change the Time mode, first move the cursor to the TIME. The current mode will be highlighted.

Press ENTER and the ARROW button to activate: Title Elapsed, Title Remaining, Chapter Elapsed, Chapter Remaining. Depending on the choice made, the bar will show a graphic view on where the disc is currently playing.

PLAYER Menu



Once all the settings have been made, you are ready to enjoy your HS 100. Once you have inserted a disc into the drawer you can explore the PLAYER Menu. This menu hosts all playback and program features, as well as all disc information. As you will see, the layout of this menu is comparable to the SET-UP Menu. The submenus are shown on the left side of the screen, with INFO and PROGRAM activated by default. As in the SET-UP Menu, settings can be highlighted with the ARROW **10** buttons and selected with the ENTER **7** button on the remote control. Options for the settings are shown in the Lower Menu Line on the bottom of the screen.

Disc: Shows the name of the disc given by the artist.

Audio: Shows the audio track that is currently playing. Options are shown on both Menu Lines on the bottom of the screen.

Playlist: Sets the order in which the current disc is played back.

Repeat: Sets the repeat mode.

Random: Activates Random Playback when possible.

Subtitle: Shows the subtitle of the disc currently playing.

In the PLAYER Menu, the chapter, track or picture currently playing will be marked with an arrow symbol in front of the Chapter (DVD), Track (CD, MP3, WMA) or Picture (JPEG). Chapters, tracks and pictures can be selected from this list at any time by moving the cursor to the desired chapter or track and pressing ENTER **7** to confirm.

The top part of this screen can be de-activated to show the complete Track list on the screen. To de-activate, move the cursor to the upper INFO (or i INFO) Submenu on the left side of the screen. Press ENTER **7** until the icon is highlighted in light blue and the full Track list is visible on the screen. In the same way the Disc list can be removed from the screen by de-activating the PROGRAM Submenu.

When the HS 100 is in play mode, pressing the PLAY button on the remote control will highlight the track being played.

Information Displays



In DVD and MP3 mode, activating the DISC INFO (DVD) or ID3 INFO (MP3) Submenu will show information about the player and the disc currently playing. The first lines will show Disc Name and Disc ID. Below you can compare the Aspect Ratio, Video Standard and Scan Type available on the disc with the actual output of your player or ID3 info for MP3 files.

In the lower part of the screen the Audio Resolution and Audio Format are shown, (DVD only) and at the bottom a graphical presentation of the Video Bit Rate (DVD only) and the Audio Bit Rate of the disc currently playing.

Programmed Play

In STOP mode, the Disc List can be used to create your own program list for DVD, CD, MP3, WMA or JPEG discs. Move the cursor to the right of the menu, into the Disc List. If the disc list is not active, move the cursor to the PROGRAM icon on the left to activate. Move the cursor to the Disc List, and select clear to clear the current list. Once the disc list is clear move the cursor up or down to the first track you would like to program and press ENTER **7**. The cursor will move to the options in the Lower Menu Line. You can either add the selected track (or picture) to the playlist or give it the number you would like it to have in your playlist, or clear the track from the list. Move the cursor down to the next track you would like to program and continue until your

playlist is complete. Once completed, move the cursor up to the Playlist setting. Select Programmed order from the options and press PLAY to start the playback.



If you have a disc that contains both MP3 files and JPEG images, you can choose to run these simultaneously, mixing the MP3 audio with your own images. The time interval can be chosen in the Picture Setting.

Also you can have the image files follow the audio signal: at the end of each audio track, the next JPEG image will be shown.

With such discs, you can also either listen to the MP3 audio or watch the JPEG video files only. In order to do so, click on the AUDIO or PICTURE icons on the left part of the screen to select or deselect the desired format. Once done, the tracklist will only show the MP3 or JPEG files.

Radio Menu

The FM Tuner in the HS 100 can be used to listen to the Radio. Before listening to the radio stations, you need to preset your favorite stations. The easiest way to do so is with the OSD screen on your monitor.

1. Press the ON button **1** on the remote control to turn the DVD Receiver on. Make sure that the Main Power Switch on the front panel is in the On position, shown by the blue LED surrounding the button. Also make sure that your video monitor connected to the HS 100 is switched on.
2. Press the RADIO button **32** on the remote control or SOURCE **5** on the front panel repeatedly, to select the FM Radio. The TV monitor will show the RADIO Menu, as shown below. You can also select the RADIO Menu with the ARROW **10** keys on the remote control. Once the RADIO tab is highlighted, press ENTER **7** to access the RADIO Menu.



Player/Radio Menu

The RADIO Menu shows the selected Audio mode, the name of a station currently played (as long as RDS is available) and a Station list listing the 30 stations with their preset, station name and frequency.

Note: The stations can be preset automatically or manually. The Manual Preset mode is described first. The Auto Preset mode is described on the next page.

3. The RDS and AUTO Tune functions are switched on by default, shown by the dark blue icons, to make the process of tuning your favorite stations as easy as possible. Move the cursor to the end of the first station line in the menu. The frequency will be highlighted and a brief explanation will appear in the Upper Menu Line on the bottom of the menu.

NOTE: Both RDS and AUTO Tune functions can be switched off by moving the cursor button to the icon at the left side of the menu and pressing the Enter Button on the remote control so that it turns light blue.

4. Pressing the search ► / ◀ button **18 20** will scan the FM band for the first available radio station with acceptable reception. The scan will stop once a station is found and the name of the station will be displayed (as long as RDS is transmitted by the station). The station will be stored automatically on the current preset.

If you know the frequency of your station, you can also tune the frequency directly with the help of the numeric keys of the remote control. Move the cursor to the end of the station line and press the frequency with the numeric keys. Press Enter **7** twice to store.

5. Move the cursor to the next station line in the menu. Follow the directions in step 3 and in the Upper Menu Line to store all your radio stations in the tuner's memory.

Rearranging the station list

Once all the stations have been stored in the memory, you can rearrange the station list, putting your favorite stations on top of the list.

1. Move the cursor in the left column in the station list to the first station you would like to rearrange.
2. Press Enter **7** to activate the current station. The cursor will move to the Lower Menu Line of the screen.
3. Select the desired preset from the list by moving the cursor right or left. Press Enter **7** to activate the change. The cursor will move back to the new station line.
4. Repeat step 3 until all radio stations have been rearranged according to your preferences.

Selecting presets

Once rearranged, presets can be chosen at any time by pressing the numeric key corresponding to the preset you would like to listen to. Depending on whether the RDS function is active, the station name will show on the front panel Information Display.

Pressing the Previous/Next ► / ◀ Button **15 16** will select the next radio station.

Presets can also be chosen in the Radio Menu. Move the cursor to the preset you would like to listen to and press Enter **7** to activate. An arrow in front of the preset will light to show the active radio station. The cursor can be moved around the menu without changing the current radio station. Pressing the Previous/Next ► / ◀ Button **15 16** at any position in the menu will select the next radio station, that is for instance from preset 3 to preset 4, even if the cursor is highlighting preset 11. Pressing the Play button will always return the cursor to the current station played, no matter were it was previously (even when another menu is open).

Removing presets

If you wish to remove presets from your preset list, follow the steps below.

1. Move the cursor in the left column in the station list to the preset you would like to remove.
2. Press Enter **7** to activate the current station. The cursor will move to the Lower Menu Line of the screen.
3. Select Remove from the list and press Enter **7**. The cursor will move back to the original station line.
4. Repeat step 3 until all radio stations you would like to delete have been removed.

Auto Preset function

When the cursor is moved to Pre-Set on top of the preset numbers you can activate the Auto Preset function, clear the complete frequency list or restore all default frequencies set by the factory.

When the Auto Preset is selected the tuner will scan the full FM range and store all stations with acceptable reception one after another on the presets. The frequency scanned will appear on the left lower side of the menu while the frequency of each station stored will be shown on the right side of the list. When the complete FM range is scanned or all presets (30) are loaded with stations the scan will stop and the first preset be selected.

You also can stop the scan at any time by pressing the STOP button **19**. Stations can be rearranged by following the explanations in the chapter "Rearranging the station list" on page 19.

RDS Station ID

With the help of RDS (Radio Data System) you can show the name of the station you are currently listening to as well as the station names of all other presets.

The RDS function is set to active by default, shown by the dark blue RDS icon at the left of the menu. In this mode, all station names will be visible both on the OSD menu as well as on the Information Display on the front panel.

If the RDS function on the left side of the menu is inactive (light blue), you will only see the frequency of the current preset shown in the menu and on the front panel display. The Station Name line on top of the menu will disappear, but the name of all other stations preset will keep in the list.

Pressing STATUS **14** on the remote will change the front panels display's indication from the frequency to the name of an RDS station or vice versa.

Surround Mode for Tuner

As with all other inputs of the HS 100, you can also select your preferred surround mode when listening to the radio. The actual surround mode is listed on the first line of the tuner menu. Follow the steps below to change the surround format:

1. Move the cursor to the AUDIO line on the top of the tuner menu. The actual surround format will be highlighted. Press Enter **7** to activate the possible surround formats. These will be shown in the bottom line of the menu.
2. Move the cursor right or left, until the desired surround format is highlighted.
3. Press Enter **7** to activate the change. The setting will apply to all tuner presets.

Note: Like with all other inputs of the HS 100 the Audio mode can easily be selected by pressing the AUDIO button **6** on the remote repeatedly until the desired surround mode appears in the first line of the OSD menu.

TV Menu, AUX Menu, Digital in Menu

TV MENU

As a Scart audio/video cable contains both audio and video inputs and outputs in one cable, the Scart connector between the DVD Receiver and the TV can also be used to lead the audio output signals of your TV to the DVD Receiver. In this way your TV programs can be listened to over your HS sound system.

NOTE: Please make sure that the Scart cable used has all pins connected. If not, only the video signal from the DVD Receiver will be lead to the TV.

1. Press the ON button **1** on the remote control to turn the DVD Receiver on. Make sure that the Main Power Switch on the front panel is in the On position, shown by the blue LED surrounding the button. Also make sure that your video monitor connected to the HS 100 is switched on.
2. Press the TV button **33** on the remote control or SOURCE **5** on the front panel repeatedly to select the Scart as the input source. The TV monitor will show the TV Menu, as shown below. You can also select the TV Menu with the ARROW keys **10** on the remote control. Once the TV tab is highlighted, press ENTER **7** to access it.

If the HS controller is already in standby, you can also switch the unit on by pressing the TV button on the remote control.



The TV Menu contains the following settings. Follow the explanations in the Upper Menu Line on the bottom of your screen to change the settings.

Audio: Selects the Surround Mode you would like to use when listening to your TV or other video device connected to the Scart input.

Level adjustment: This setting gives you the possibility to increase or decrease the input level of the TV, so that its sound will have the same level as the radio, the DVD player or the other audio inputs.

AUX MENU

In addition to the built-in DVD-Audio/Video and CD player, the built-in radio and Scart audio input, you can connect one more analog audio source to the HS 100. The analog source can be connected to the AUDIO IN input **7** connectors on the rear panel.

1. Press the ON **1** or AUX button **34** on the remote control to turn the DVD Receiver on. Make sure that the Main Power Switch on the front panel is in the On position, shown by the blue LED surrounding the button. Also make sure that your video monitor connected to the HS 100 is switched on.
2. Press the AUX button **34** on the remote control or SOURCE **5** on the front panel repeatedly to select this source as the input. The TV monitor will show the AUX Menu, as shown below.
You can also select the AUX Menu with the ARROW keys **10** on the remote control. Once the AUX tab is highlighted, press ENTER **7** to access it.



The AUX Menu contains the following settings. Follow the explanations in the Upper Menu Line on the bottom of your screen to change the settings.

Audio: Selects the Surround Mode you would like to use when listening to your additional analog audio source.

Level adjustment: This setting gives you the possibility to increase or decrease the input level of the analog input, so that its sound will have the same level as the radio, the DVD player or the other audio inputs.

DIGITAL IN MENU

In addition to all analog audio and video sources, the HS 100 also gives you the opportunity to connect two digital audio sources, for instance a digital set-top box or satellite receiver. Connect these sources to either the coaxial or optical digital input connectors on the rear panel.

1. Press the ON **1** or DIGITAL IN button **35** on the remote control to turn the DVD Receiver on. Make sure that the Main Power Switch on the front panel is in the On position, shown by the blue LED surrounding the button. Also make sure that your video monitor connected to the HS 100 is switched on.
2. Press the DIGITAL IN button **35** on the remote control or SOURCE **5** on the front panel repeatedly to select one of the digital sources as the input. The TV monitor will show the DIGITAL IN Menu, as shown below. You can also select the DIGITAL IN Menu with the ARROW keys **10** on the remote control. Once the DIGITAL IN tab is highlighted, press ENTER **7** to access it.

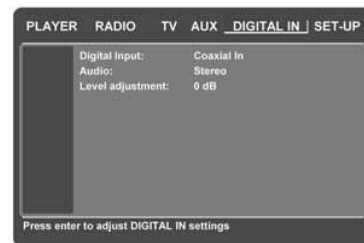

The DIGITAL IN Menu contains the following settings. Follow the explanations in the Upper Menu Line on the bottom of your screen to change the settings.

Digital input: Selects either the digital source connected to the coaxial or to the optical digital input as source to listen to.

Audio: Selects the Surround Mode you would like to use when listening to one of the digital audio sources.

Level adjustment: This setting gives you the possibility to increase or decrease the input level of the digital input, so that its sound will have the same level as the radio, the DVD player or the other audio inputs.

Surround Mode Chart

Dolby Digital: Available only with digital input sources encoded with Dolby Digital data. It provides up to five separate main audio channels and a special dedicated Low Frequency Effects channel.

DTS: Available only with digital input sources encoded with DTS data. Available on special DVD, LD and audio-only discs, DTS provides up to five separate main audio channels and a special dedicated low frequency channel.

Dolby Pro Logic II: Dolby Pro Logic II is the latest version of Dolby Laboratory's benchmark surround technology that creates or decodes full range, discrete left, center, right, right surround and left surround channels from matrix surround encoded programs and conventional stereo sources. The Dolby Pro Logic II Movie mode is optimized for movie soundtracks that are recorded with matrix surround, by creating true rear left, center and right signals. The ProLogic II Music mode should be used with musical selections, that are recorded with matrix surround or with normal stereo mode, creating discrete rear left and right signals.

DVD Language Codes

The availability of specific languages for the main audio track or subtitles is dependent on the choices made by a disc's producer. You should always consult the disc's jacket for information on languages for any disc. In the case of some languages, you may be required to enter a code from the list below to access that language.

Language	Code	Language	Code	Language	Code
Abkhazian	6566	Hausa	7265	Samoa	8377
Afar	6565	Hebrew	7387	Sangho	8371
Afrikaans	6570	Hindi	7273	Sanskrit	8365
Albanian	8381	Hungarian	7285	Scots Gaelic	7168
Ameharic	6577	Icelandic	7383	Serbian	8382
Arabic	6582	Indonesian	7378	Servo-Groatian	8372
Armenian	7289	Interlingua	7365	Sesotho	8384
Assamese	6583	Interlingue	7369	Setswana	8478
Aymara	6588	Iunpiak	7375	Shona	8378
Azerbaijani	6590	Irish	7165	Sindhi	8368
Bashkir	6665	Italian	7384	Singhalese	8373
Basque	6985	Japanese	7465	Siswati	8383
Bengali; Bangla	6678	Javanese	7487	Slovak	8375
Bhutani	6890	Kannada	7578	Slovenian	8376
Bihari	6672	Kashmiri	7583	Somali	8379
Bislama	6673	Kazakh	7575	Spanish	6983
Breton	6682	Kinyarwanda	8287	Sundanese	8385
Bulgarian	6671	Kirghiz	7589	Swahili	8387
Burmese	7789	Kirundi	8278	Swedish	8386
Byelorussian	6669	Korean	7579	Tagalog	8476
Cambodian	7577	Kurdish	7585	Tajik	8471
Catalan	6765	Laothian	7679	Tamil	8465
Chinese	9072	Latin	7665	Tatar	8484
Corsican	6779	Latvian, Lettish	7686	Telugu	8469
Croatian	7282	Lingala	7678	Thai	8472
Czech	6783	Lithuanian	7684	Tibetan	6679
Danish	6865	Macedonian	7775	Tigrinya	8473
Dutch	7876	Malagsy	7771	Tonga	8479
English	6978	Malay	7783	Tsonga	8483
Esperanto	6979	Malayalam	7776	Turkish	8482
Estonian	6984	Maltese	7784	Turkmen	8475
Faroese	7079	Maori	7773	Twi	8487
Fiji	7074	Marathi	7782	Ukrainian	8575
Finnish	7073	Moldavian	7779	Urdu	8582
French	7082	Mongolian	7778	Uzbek	8590
Frisian	7089	Naru	7865	Vietnamese	8673
Galician	7176	Nepali	7869	Volapuk	8679
Georgian	7565	Norwegian	7879	Welsh	6789
German	6869	Occitan	7967	Wolof	8779
Greek	6976	Oriya	7982	Xhosa	8872
Greenlandic	7576	Oromo (Afan)	7977	Yiddish	7473
Guarani	7178	Panjabi	8065	Yoruba	8979
Gujarati	7185	Pashto, Pushto	8083	Zulu	9085
		Persian	7065		
		Polish	8076		
		Portuguese	8084		
		Quechua	8185		
		Rhaero-Romance	8277		
		Romanian	8279		
		Russian	8285		

Troubleshooting

If you experience any of the following difficulties while using the system, use this troubleshooting guide to help you remedy the problem. Should any problem persist, consult your authorized Harman Kardon dealer.

No power.

- Is the power cord firmly plugged into the power outlet?
- One of the safety mechanisms may be operating. In this event, unplug the player from the power outlet briefly and then plug it in again.

No picture.

- Check that the system is connected correctly and securely.
- The video cable may be damaged. Replace it with a new one.
- Make sure the system is connected to a video input on the TV (see page 12).
- Make sure the TV is turned on.
- Make sure the correct video input on the TV is selected for viewing with this system.

Noise (interference) appears in the picture.

- Clean the disc.
- If video from this system has to go through your VCR to get to your TV, the copy-protection applied to some DVD programs could affect picture quality. If you still experience problems after checking your connections, please try connecting your DVD system directly to your TV's S-Video input, if your TV is equipped with this input (see page 12).

The aspect ratio of the screen is wrong (picture vertically expanded) when you play a wide picture even though you set "TV DISPLAY" in the SETUP menu to "16:9".

- If you connect the system with the SCART cable, connect directly to the TV. Otherwise the autoswitch function of the aspect ratio for the TV may not work.
- If the TV is not connected with a SCART cable to the HS, or if the autoswitch function does not work you should turn the TV to "16:9" (if possible with your TV).
- Depending on the TV, you may not be able to change the aspect ratio. In that case (TV not adjustable to 16:9) do not select "16:9" in the TV Display. Then, no change of the aspect ratio is needed.

There is no sound or volume is very low

- Check that the speakers and components are connected correctly and securely.
- Make sure that you have selected the correct source on the system.
- Press **MUTE** on the remote control, if the words MUTE ON are blinking on the front panel display.
- The protective circuitry has been activated because of a short circuit. Turn off the system, eliminate the short circuit problem and turn on the power again.
- The audio interconnect is damaged. Replace it with a new one.
- The system is in pause mode or in slow-motion play mode, or fast forward or fast reverse. Press ► to return to normal play mode.
- Check the speaker settings (see page 16).

The left and right channels are unbalanced or reversed.

- Check that the speakers and components are connected correctly and securely.

Severe hum or noise is heard.

- Check that the speakers and components are connected securely.
- Check that the connecting cords are away from a transformer or motor and at least 3 meters away from fluorescent light.
- Move your TV away from the audio components.
- The plugs and jacks are dirty. Wipe them with a cloth slightly moistened with alcohol.
- Clean the disc.

The surround effect is difficult to hear when you are playing a Dolby Digital sound track.

- Check to see if the Dolby Digital mode is turned on properly, otherwise unload and load the disc again.
- Check the speaker connections.
- Depending on the DVD disc, the output signal may at times be mono or stereo even if the soundtrack is recorded in Dolby Digital format.

The sound comes from the center speaker only.

- Depending on the disc, sound may sometimes come from the center speaker only. This also applies to mono recordings (from disc or any analog source), when Pro Logic mode is selected. This is normal.

No sound is heard from the center speaker.

- Adjust center speaker volume (see pages 16).

No sound or only very low volume from the rear speakers.

- Adjust the rear speaker volume (see page 16).

Radio stations cannot be tuned in.

- Check that the antenna is connected correctly. Adjust the antenna and connect an external antenna if necessary.
- The signal strength of the stations is too weak for automatic tuning. Use manual tuning.
- No stations have been preset.
- The tuner mode is not selected, select the Radio mode.

The remote does not function.

- Remove any obstacles between the remote control and the system.
- Move the remote control closer to the system.
- Point the remote control at the remote sensor on the front panel.
- Replace all the batteries in the remote control with new ones if they are weak.
- Check that the batteries are loaded correctly.

The disc does not play.

- There is no disc inside. ("NO DISC" appears on the front panel display and the TV screen.) Insert a disc.
- Insert the disc correctly with the playback side facing down on the disc tray.
- Clean the disc.
- The system cannot play CD-ROM's, etc. (see page 3).
- DVD with wrong region code (see page 11).

The system starts playing the DVD automatically.

- The DVD features the auto playback function.

Playback stops automatically.

- Some discs include an auto pause signal. When playing such a disc, the system stops playback at the signal.

Track Skip or direct select with numeric buttons, Search, Slow-motion play, repeat play or Program play, etc., cannot be done.

- Depending on the DVD, some of the above operations may not be available (Playback control with DVD).

Messages do not appear on the TV screen in the language you want.

- Select the language for OSD in the SETUP menu (see page 15).
For all messages from the DVD (DVD menu, subtitles) in the proper language the disc must have the language you selected, if not, another language will be selected.

The audio language cannot be changed when you play a DVD.

- Multilingual sound is not recorded on the DVD.
- Changing the language for the sound is prohibited on the DVD.

The subtitle language cannot be changed when you play a DVD.

- Multilingual subtitles are not recorded on the DVD.
- Changing the language for the subtitles is prohibited on the DVD.

The subtitles cannot be turned off when you play a DVD.

- Depending on the DVD, you may not be able to turn the subtitles off.

The angles cannot be changed when you play a DVD.

- Multi-angles are not recorded on most DVDs.
- Change the angles when the angle mark appears on the TV screen.
- Changing the angles is prohibited on some DVDs.

The system does not operate properly.

- Static electricity, etc., may affect the system's operation.
Disconnect the AC power cord, then connect it again.

Please also refer to the Troubleshooting guide contained in your loudspeaker Owners Manual

Glossary

Bit rate

Value indicating the amount of video data compressed in a DVD per second. The unit is Mbps (megabit per second). 1 Mbps indicates that the data per second is 1,000,000 bits. The higher the bit rate, the larger the amount of data. However, this does not always mean higher quality pictures.

Chapter

Sections of a picture or a music piece on a DVD that are smaller than titles. Many titles are composed of several chapters, but many others are not. Each chapter is assigned a chapter number enabling you to locate the chapter you want.

Dolby Digital ("5.1", "AC-3")

This sound format for movie theaters is more advanced than Dolby Pro Logic Surround. In this format, the rear speakers output stereo sound with an expanded frequency range and a subwoofer channel for deep bass is independently provided. This format is also called "5.1" because the subwoofer channel is counted as 0.1 channel (since it functions only when a deep bass effect is needed). All six channels in this format are recorded separately for superior channel separation. Furthermore, since all the signals are processed digitally, less signal degradation occurs. The name "AC-3" comes from the fact that it is the third audio coding method to be developed by the Dolby Laboratories Licensing Corporation.

Manufactured under license from Dolby Laboratories. "Dolby", "AC-3", "Pro Logic" and the Double-D symbol are trademarks of Dolby Laboratories. Confidential Unpublished Works. © 1992.1997 Dolby Laboratories, Inc. All rights reserved.

Dolby Pro Logic II Surround

This is a method of decoding surround recordings that produces five channels from two-channel sound. Compared with the former Dolby Surround system, Dolby Pro Logic II Surround reproduces left-to-right panning more naturally and localizes sounds more precisely. To take full advantage of Dolby Pro Logic II Surround, you should have a pair of rear speakers and a center speaker. The rear speakers output stereo sound.

DTS

Digital audio compression technology developed by Digital Theater Systems, Inc. This technology conforms to 5.1-channel surround. The rear channels are stereo and there is a discrete subwoofer channel in this format. DTS provides 5.1 discrete channels of high quality digital audio. Good channel separation is realized, because all channels are recorded discretely and processed digitally.

Manufactured under license from Digital Theater Systems, Inc. US Pat. No. 5,451,942 and other worldwide patents issued and pending. "DTS" and "DTS Digital Surround" are trademarks of Digital Theater Systems, Inc. © 1996 Digital Theater Systems, Inc. All rights reserved.

MPEG AUDIO

International standard coding system to compress audio digital signals authorized by ISO/IEC. MPEG 1 conforms to up to 2-channel stereo, used on some DVD's as alternate (other language) track.

DVD

A disc that contains up to 8 hours of moving pictures even though its diameter is the same as a CD. The data capacity of a single-layer and single-sided DVD, at 4.7 GB (Giga Byte), is 7 times that of a CD. Furthermore, the data capacity of a dual-layer and single-sided DVD is 8.5 GB, a single-layer and double-sided DVD 9.4 GB, and a dual-layer and double-sided DVD 17 GB. The picture data uses the MPEG 2 format, one of the worldwide standards of digital compression technology. The picture data is compressed to about 1/40 of its original size. The DVD also uses the variable rate coding technology that changes the data to be allocated according to the status of the picture. The audio data is recorded in Dolby Digital, DTS and/or PCM, allowing you to enjoy more natural audio presence. Furthermore, various advanced functions such as multi-angle, multilingual, and subtitles may be provided with the DVD.

Multi-angle function

Various angles or viewpoints of the video camera for a scene are recorded on some DVDs.

Multilingual function

Several languages for the sound or subtitles in a picture are recorded on some DVDs.

Parental Control

A function of some (particular US) DVD's to limit playback of the disc by the age of the users. The limitation varies from disc to disc. When it is activated, playback is completely prohibited, violent scenes are skipped or replaced with other scenes and so on.

Title

The longest sections of a picture or a music piece on a DVD; a movie, etc., for a picture piece on video software; or an album, etc., for a music piece on an audio software. Each title is assigned a title number enabling you to locate the title you want.

Track

Sections of a music piece on a CD. Each track is assigned a track number enabling you to locate the track you want.

PCM

Pulse code modulation, an uncompressed data formation.

NTSC

National TV Systems Committee: a video standard used in USA.

PAL

Phase Alternation Line: a video standard used in many European countries.

HS 100 Controller Specifications

DVD player

Pickup:	Semiconductor laser, wavelength 650nm
Signal system:	NTSC / PAL
Video signal horizontal resolution:	More than 480 lines (DVD)
Video signal-to-noise ratio:	More than 60 dB (DVD)
Audio frequency response: (Stereo)	DVD (PCM): 20Hz ~ 22kHz (+/- 1.0dB) CD (PCM): 20Hz ~ 20kHz (+/- 1.0dB)
Audio signal-to-noise ratio:	More than 80 dB (PCM)
Total harmonic distortion::	Less than 0.01% (PCM)
Dynamic range:	DVD (PCM): More than 85 dB (EIAJ, 2kHz) CD: More than 85 dB (EIAJ)

FM Tuner

System:	PLL quartz-locked digital synthesizer system
Tuning range:	87.50 ~ 108.00 MHz
Antenna terminals:	75 ohms, unbalanced
Intermediate frequency:	10.7 MHz

Video Outputs

Component Video Output:	Y: 1 Vp-p/75 Ohms, sync negative polarity Cr: 0.7 Vp-p/75 Ohms Cb: 0.7 Vp-p/75 Ohms
CVBS Video:	1 Vp-p 75 ohms
S-video:	Y: 1 Vp-p 75 ohms C: PAL 0.3 Vp-p 75 ohms / NTSC 0.286 Vp-p 75 ohms

Audio line Outputs

Audio L/R:	2 Vrms, 1 kilohms
------------	-------------------

General

Power requirements:	AC 230 V, 50 Hz
Max power consumption:	380 W
Idle power consumption:	Less than 2 W
Dimensions (WxHxD):	440mm x 68mm x 380mm
Weight:	8,5 kg

* Designs and specifications are subject to change without notice.

Depth measurement includes knobs, buttons and terminal connections. Height measurement includes feet and chassis.

All features and specifications are subject to change without notice.

Harman Kardon and Power for the Digital Revolution are registered trademarks of Harman International Industries, Incorporated.

Dolby, Pro Logic and the double-D symbol are trademarks of Dolby Laboratories, registered in the United States and/or other countries. All rights reserved.

DTS is a trademark of Digital Theater Systems, Inc.

Windows Media® Audio (WMA) is a proprietary file format developed by Microsoft.

CONSUMERS SHOULD NOTE THAT NOT ALL HIGH DEFINITION TELEVISION SETS ARE FULLY COMPATIBLE WITH THIS PRODUCT AND MAY CAUSE ARTIFACTS TO BE DISPLAYED IN THE PICTURE. IN CASE OF 525 OR 625 PROGRESSIVE SCAN PICTURE PROBLEMS, IT IS RECOMMENDED THAT THE USER SWITCH THE CONNECTION TO THE 'STANDARD DEFINITION' OUTPUT. IF THERE ARE QUESTIONS REGARDING OUR TV SET COMPATIBILITY WITH THIS MODEL 525p AND 625p DVD PLAYER, PLEASE CONTACT OUR CUSTOMER SERVICE CENTER.

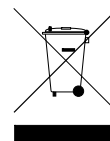

harman / kardon

H A Harman International Company
250 Crossways Park Drive, Woodbury, New York 11797
516.422.HKHK (4545) Fax: 516.682.3523 (USA only)
www.harmankardon.com
Harman Consumer Group International:
2, route de Tours, 72500 Château-du-Loir, France
© 2005 Harman Kardon, Incorporated
Part No.: 312-AH0HS100-0000