

SCIENTIFIC DATA SYSTEMS, INC.

---

**Warrior Wireless Serial Adapter.**

# Warrior Wireless Serial Adapter

This document contains proprietary information. Copyright © 2005 Scientific Data Systems, Inc.  
All rights reserved.

WIRELESS SERIAL COMMUNICATIONS ASSEMBLY ( WWSA )

# WWSA Manual

---

This document contains proprietary information.  
Copyright © 2005 Scientific Data Systems, Inc. All rights reserved.  
16840 Clay Road • Suite 105  
Houston, Texas 77084, USA  
Phone: 1- 281-550-1109 • Fax: 1- 281-550-2068  
E-mail: [sds.info@warriorsystem.com](mailto:sds.info@warriorsystem.com)  
Website: [www.warriorsystem.com](http://www.warriorsystem.com)  
Created January 8, 2014

Windows® is a registered trademark of Microsoft Corporation in the United States and/or other countries.  
All other product names are trademarks of their respective companies.

# Table of Contents

<b>TABLE OF CONTENTS</b> .....	<b>3</b>
<b>1 WWSA INTRODUCTION</b> .....	<b>4</b>
<i>Fig 1.1 WWSA</i> .....	5
<b>2 WWSA SOFTWARE CONFIGURATION</b> .....	<b>6</b>
<b>ASCTEL CONFIGURATION</b> .....	<b>6</b>
<i>Fig 2.1</i> .....	6
<i>Fig 2.2</i> .....	6
<i>Fig 2.3</i> .....	7
<i>Fig 2.4</i> .....	8
<i>Fig 2.5</i> .....	9
<i>Fig 2.6</i> .....	10
<i>Fig 2.7</i> .....	11
<i>Fig 2.8</i> .....	12
<i>Fig 2.9</i> .....	13
<b>SERMON CONFIGURATION</b> .....	<b>14</b>
<i>Fig 2.8</i> .....	14
<i>Fig 2.9</i> .....	14
<i>Fig 2.10</i> .....	15
<i>Fig 2.11</i> .....	16
<b>3 WWSA CONFIGURATION</b> .....	<b>18</b>
<b>3.1 RADIO DIP SWITCHES</b> .....	<b>18</b>
<i>Fig 3.1</i> .....	19
<b>3.2 RADIO JUMPERS</b> .....	<b>19</b>
<i>Fig 3.2</i> .....	19
<b>3.3 PAIRING THE DEVICES</b> .....	<b>20</b>
<b>3.4 LED BEHAVIOR</b> .....	<b>21</b>
<b>Master Radio LEDs</b> .....	21
<b>Slave Radio LEDs</b> .....	21
<b>4 WWSA MAIN BOARD DESCRIPTION</b> .....	<b>22</b>
<b>4.1 WWSA R1 BOARD</b> .....	<b>22</b>
<i>Fig 4.1 WWSA Schematic</i> .....	23
<i>Fig 4.2 WWSA Board Layout</i> .....	24
<i>Fig 4.3 WWSA Wiring</i> .....	25
<i>Fig 4.4 WWSA Panel</i> .....	26
<b>5 WWSA WIRELIST</b> .....	<b>27</b>
<b>WIRE LIST FOR WWSA</b> .....	<b>27</b>
<b>Connector Outputs</b> .....	27
<b>PCB Board Connectors</b> .....	28
<b>6 WINDOWS DRIVER INSTALLATION</b> .....	<b>29</b>

# 1 WWSA Introduction

The Wireless Serial Communications Assembly allows the warrior logging system to receive or transmit ASCII log data between two remote computers wirelessly.

Examples:

- a. Well head pressure, pump rate and total barrels from a pumping truck
- b. Line speed and depth from an endless tubing unit running either memory gauges or wireline.

The system consists of two ruggedized cases containing 120v power connection and a USB interface.



Fig 1.1 WWSA

## 2 WWSA Software Configuration

### ASCTEL configuration

ASCTEL is the Serial data receiver module required to receive real time serial data into the warrior system. The ASCTEL module can receive up to 10 ASCII words as data depending on its configuration. The configuration of the module is done in the Service editor.

Open the service editor and select the service you wish to add ASCTEL to. Then from the top menu select Add>>>Device. The window in Fig 2.1 will open

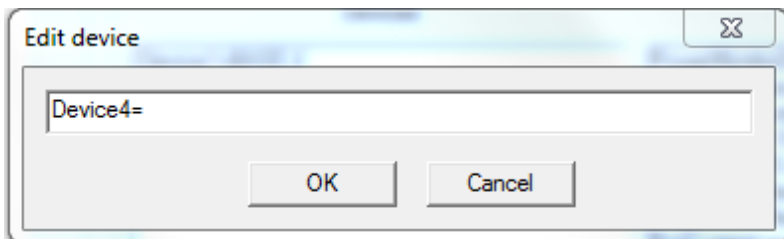

Fig 2.1

Type "ASCTEL,10,ifs,n=9" into the window .

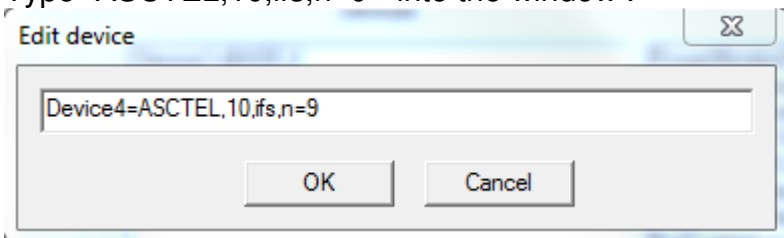

Fig 2.2

Then click OK.

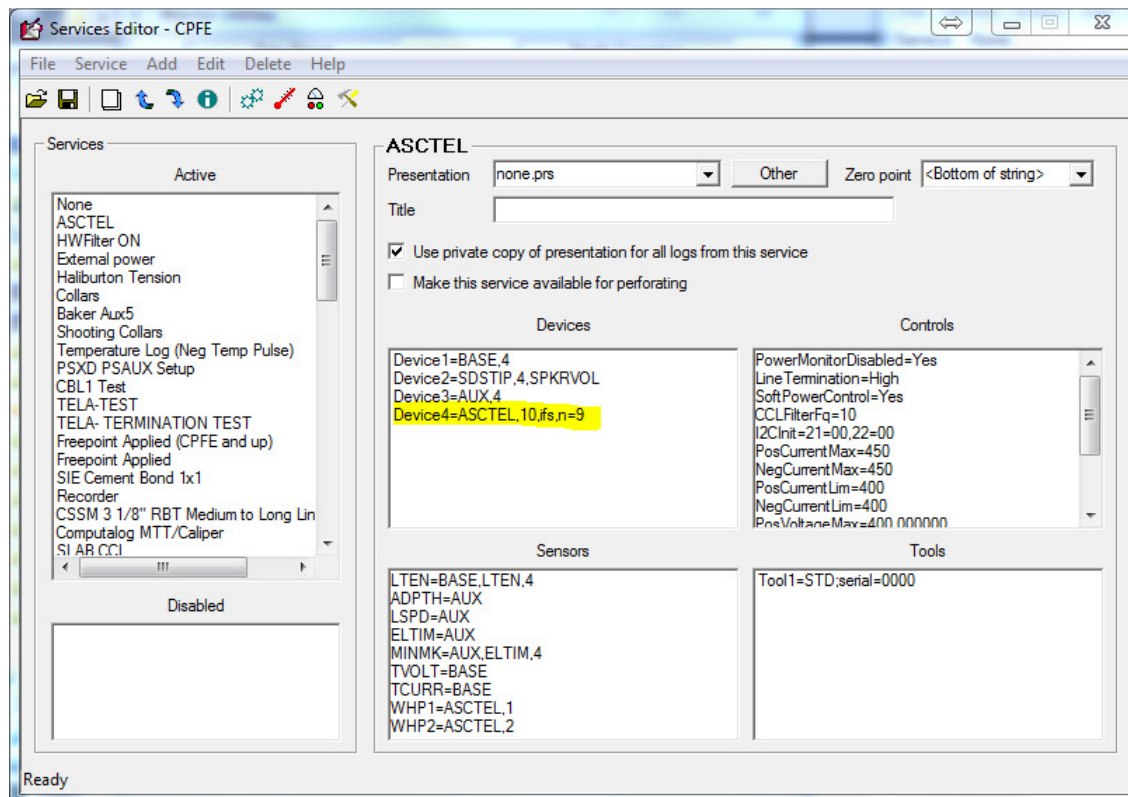

Fig 2.3

Device4=ASCTEL,10,ifs,n=9 in the screen shot above configures the warrior system to expect serial data input. The 10 indicates to the system record @10 samples per second. The ' ifs ' informs the system to use space delineated ASCII data ( use as default ). The "n=9" in this instance tells the system to expect 9 words in each frame.

For curves that you want to update even when not logging add them to the Device line in comma delineated fashion. Eg. ASCTEL,10,ifs,n=9, Depth=1

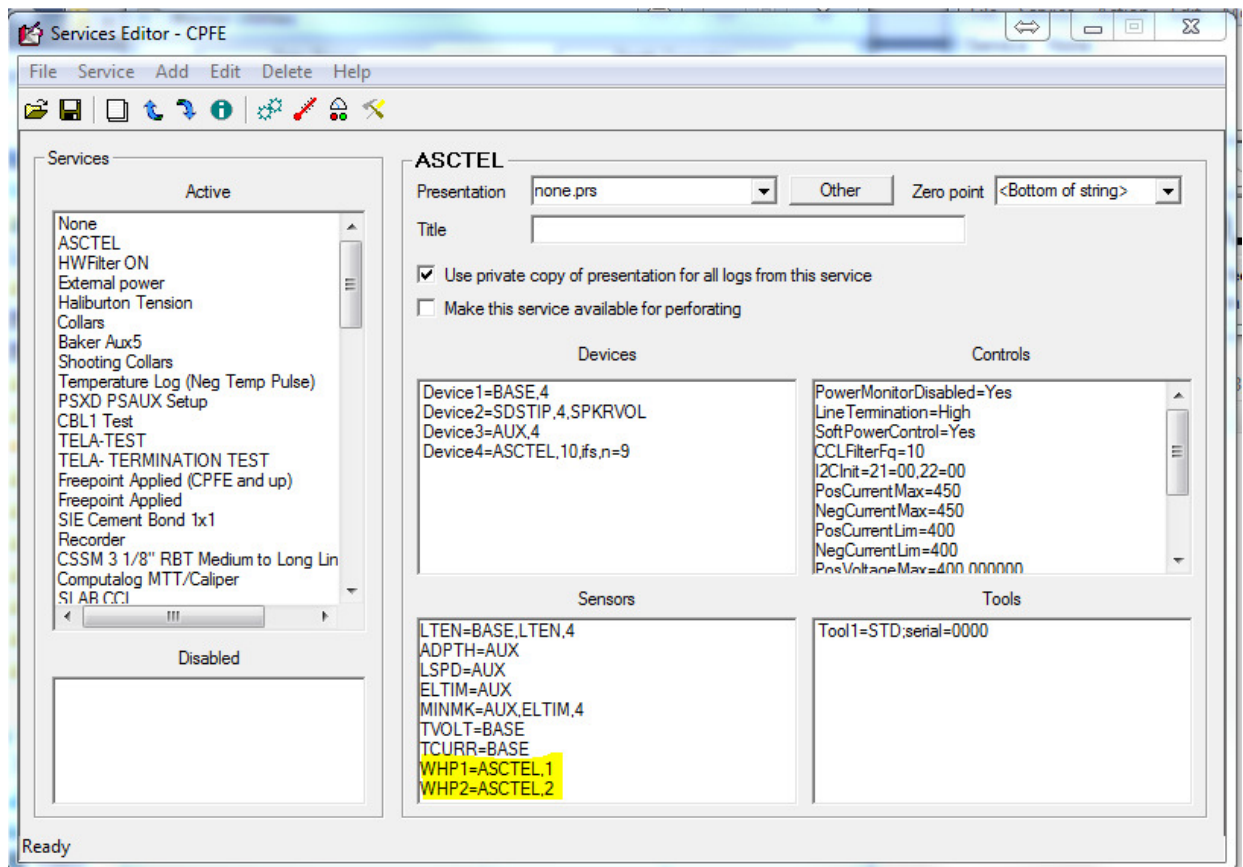

Fig 2.4

Now that You have configured the ASCTEL to receive data you must associate that data with specific mnemonics. In the example above the WHP1=ASCTEL,1 sets the first input word to WHP1 “ well head pressure 1 “ and the WHP2=ASCTEL,2 sets the second word to WHP2 “well head pressure 2”. In this case both WHP1 and WHP2 are sensors that come from the STD tool.



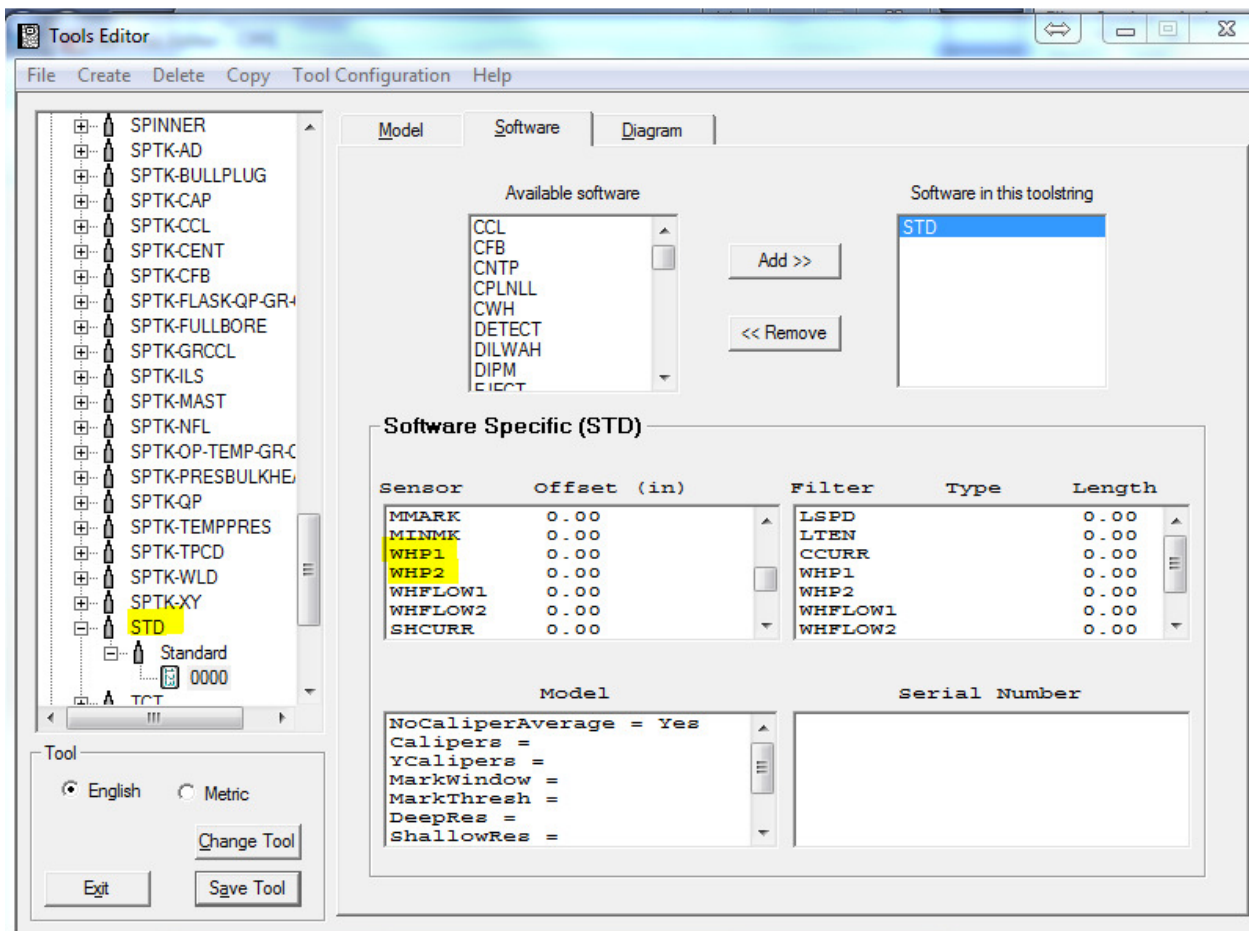

Fig 2.5

You must use sensors that are defined by either the STD tool or another tool that you have selected in your tool string.

## Checking communications

Once you have configured the ASCTEL module into your service you should check your port configuration. Load the service that contains the ASCTEL device and from the top menu select Edit>>>Device Configuration>>>ASCTEL. This should open a window similar to Fig 2.6

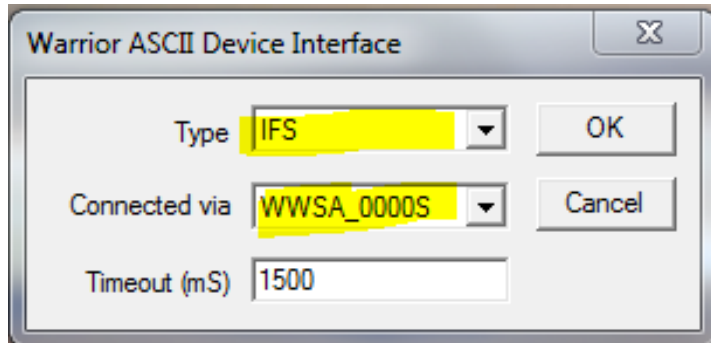

Fig 2.6

You may receive an error when loading the service, this usually indicates that the COM port must be configured.

Check that IFS is selected from the "Type " pull down and that the Connected via has the correct COM port. In this example it is WWSA\_0000S. This represents serial number 0000 and " S " as in slave. The ASCTEL device should be the first in the list, and should be your choice. The list of ports shown in the pull down should only show the ports available on your computer.

If you go to the windows device manager you will not see this device but rather the equivalent COM port. In the example Fig 2.7 it is port 10.

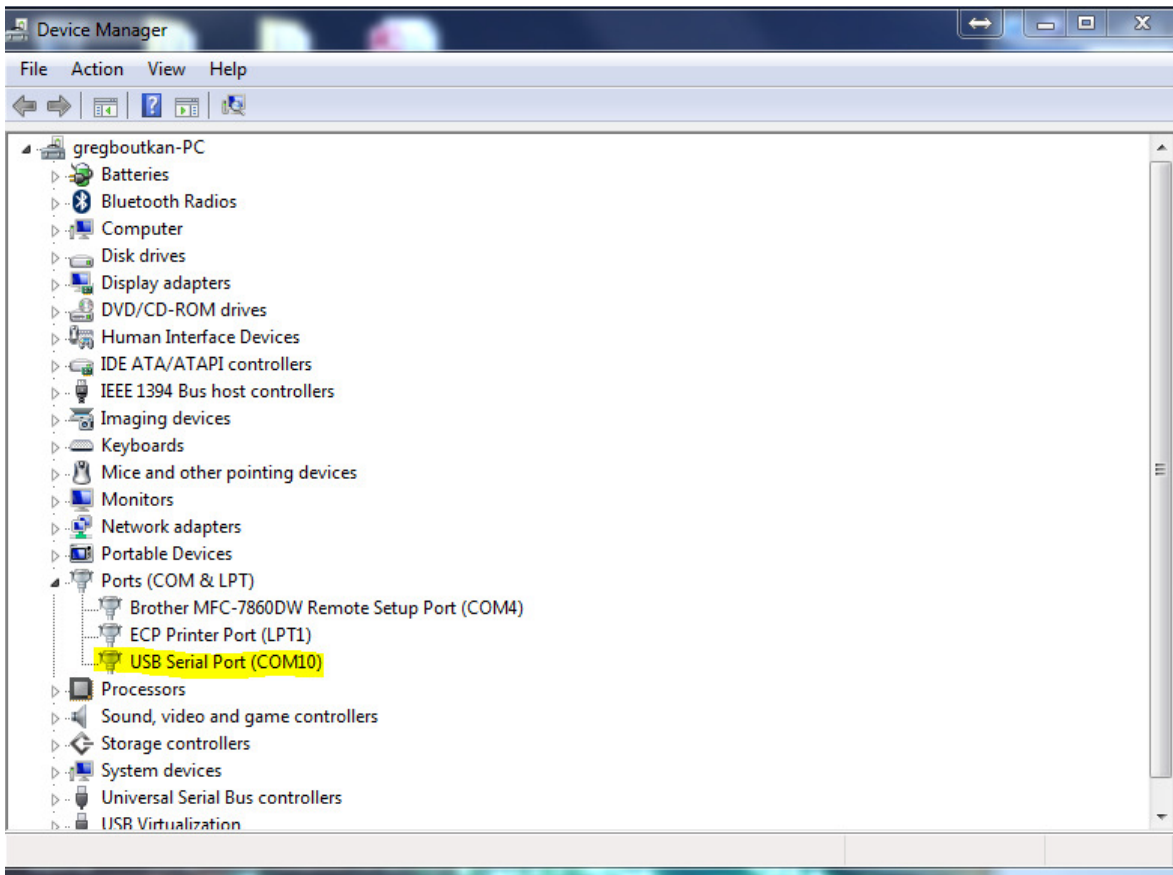

Fig 2.7

To ensure that you are looking at the correct port you can turn off the WWSA and it should disappear from the list.

If you double click on the port it will open another window, go to the Port Settings tab and ensure that the port is set to 9600 baud, 8 bits, no parity 1 stop bit and Flow Control set to none. See Fig 2.8

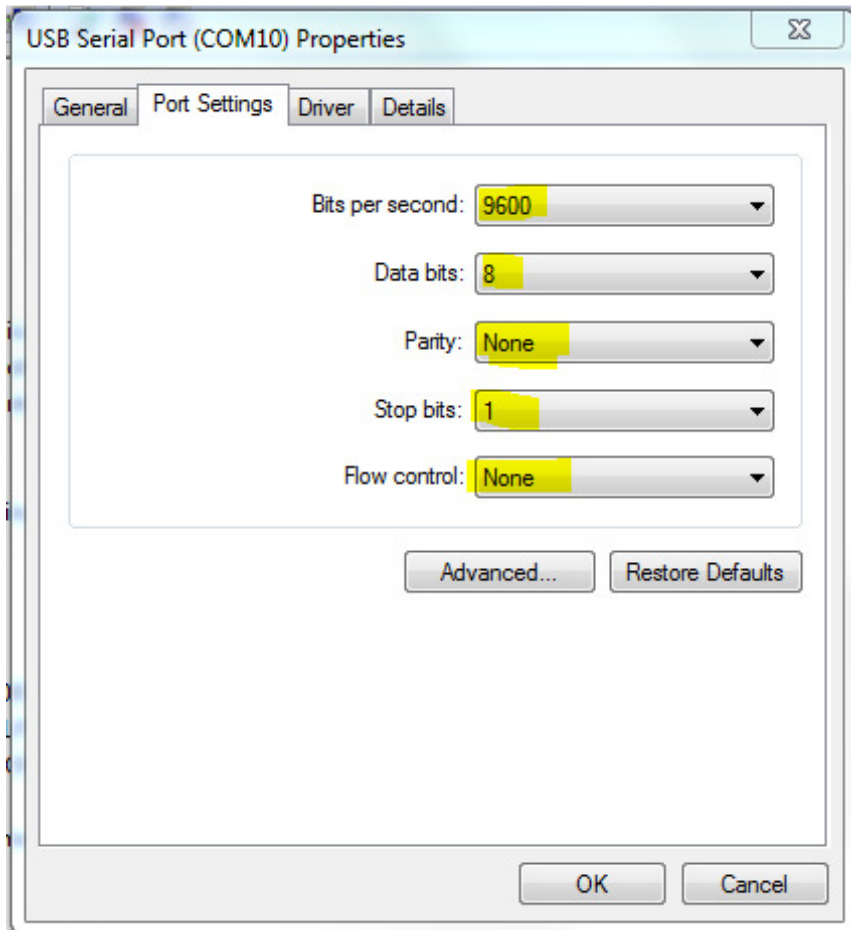
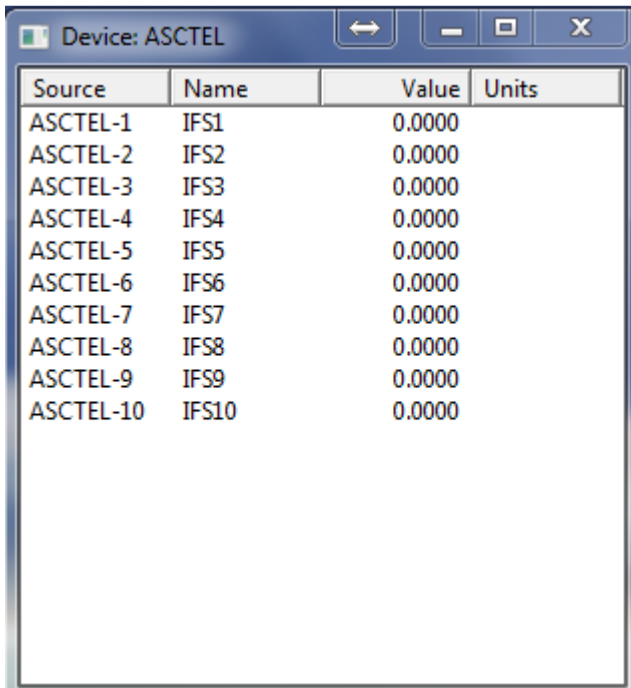

Fig 2.8

Once this is done you should be able to go to Monitor>>>Devices>>>ASCTEL. This should pop up a screen showing your ASCTEL channels similar to Fig 2.9.



The screenshot shows a window titled "Device: ASCTEL" with a table containing 10 rows of data. The table has four columns: "Source", "Name", "Value", and "Units". Each row represents an ASCTEL channel (ASCTEL-1 to ASCTEL-10) with a corresponding name (IFS1 to IFS10) and a value of 0.0000. The "Units" column is currently empty.

Source	Name	Value	Units
ASCTEL-1	IFS1	0.0000	
ASCTEL-2	IFS2	0.0000	
ASCTEL-3	IFS3	0.0000	
ASCTEL-4	IFS4	0.0000	
ASCTEL-5	IFS5	0.0000	
ASCTEL-6	IFS6	0.0000	
ASCTEL-7	IFS7	0.0000	
ASCTEL-8	IFS8	0.0000	
ASCTEL-9	IFS9	0.0000	
ASCTEL-10	IFS10	0.0000	

Fig 2.9

Once this is completed you should be able to do a record on time to ensure that the data you expect is indeed being logged.

# SERMON Configuration

SERMON can be thought of as the opposite of ASCTEL, it outputs serial data to a specific com port. Set the desired COM port to the correct configuration using the windows device manager see Fig 4.7 from ASCTEL setup to confirm.

To output ASCII data using SERMON you must add a device using the Warrior Service Editor. Go to the service you want to add SERMON to and highlight it. Then select Add from the top tool bar and select Device. It will open a window similar to the one in Fig 2.8.

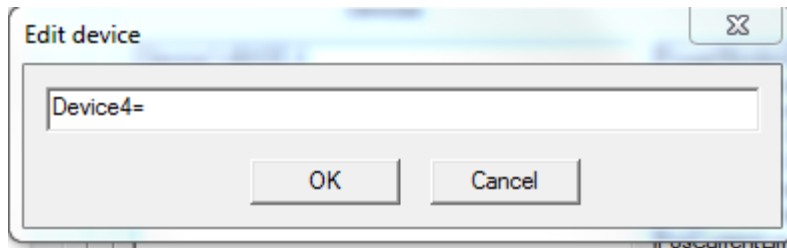

Fig 2.8

Type in SERMON,1,Data=ELTIM,ADPTH on the line. The first word SERMON indicated the module to load the 1 normally indicates the sample rate to output but in SERMON it is a place holder. In SERMON you select a millisecond repeat rate in the control window for your output rate. The Data= indicates the mnemonics to output. For some curves such as CCL you would probably request to output CCLRT (see CCRT in FOM).

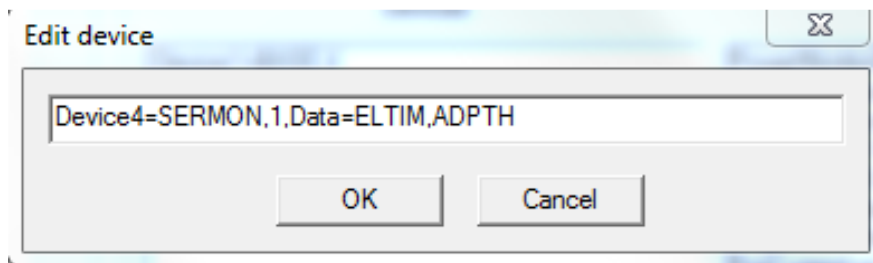

Fig 2.9

In this example we will output elapsed time and depth. Your mnemonics must match available sensors in your service separated by commas.

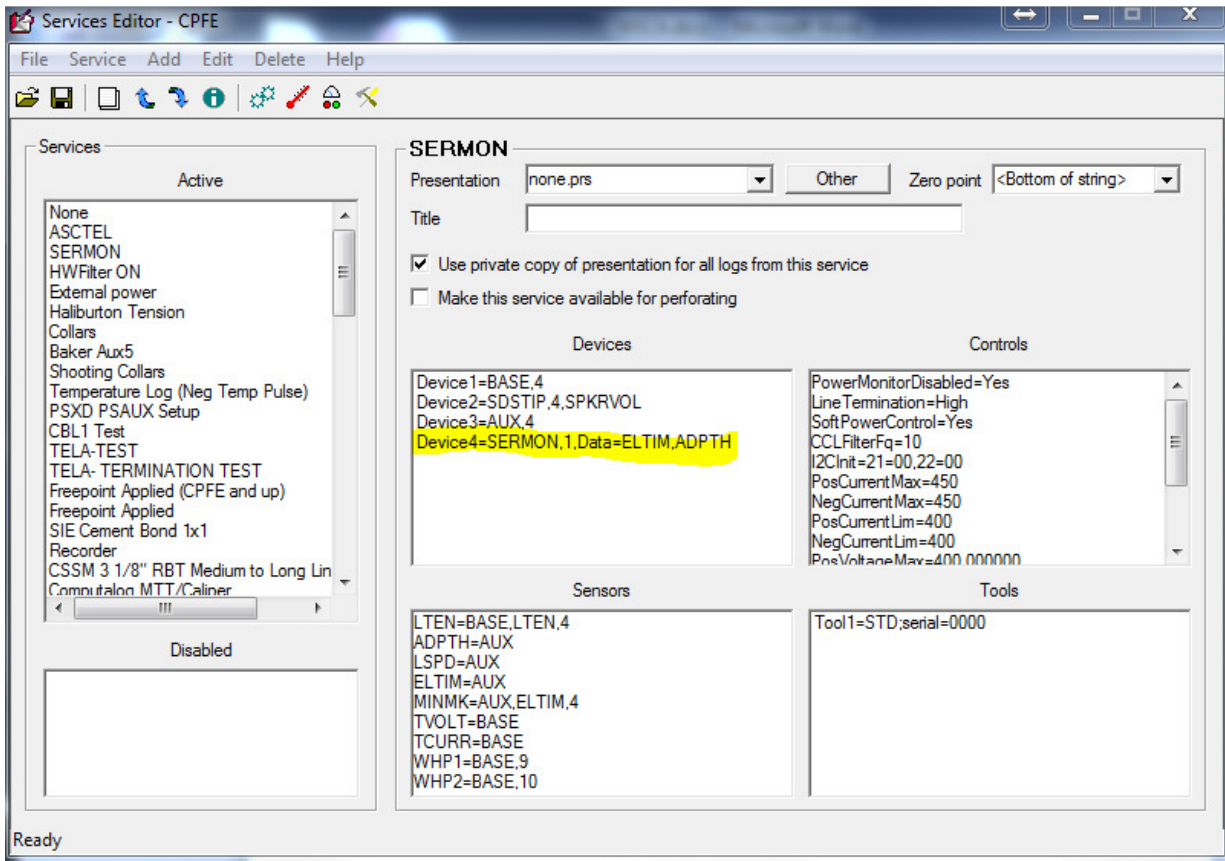

Fig 2.10

Once this is done save your service and select Acquisition.

From acquisition select the service you have added SERMON to and let it load. You may receive errors when loading. Go to Edit>>>Device Configuration>>>SERMON. Make sure that the COM Port is correct, once again the WWSA device should be the first on the list. Set the baud rate to 9600 and Type is Standard. If you do not put a checkmark in continuous the data must be poled. Under normal conditions this should be checked.

For poled data sending the following commands results in the following output.

Send	Receive
N	List of output mnemonics
D	data reading
“STX” ASCII “02”	data reading space delineated

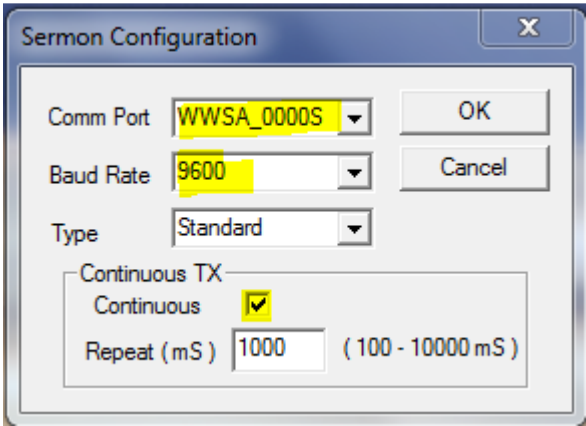

Fig 2.11





## 3 WWSA Configuration

The WWSA's only connections are a 120 volt AC and a USB connection. The USB connection will appear in the windows device menu as a serial port.

Configuration of the radios will be done at the point of sale DIP switch settings should not need to be changed but you may need to pair the devices.

### 3.1 Radio Dip Switches

The Dip switches can be found by removing the ribbon cable from the back of the radio and the back cover. There must be one master and possibly multiple slaves.

The default DIP switch settings for the Master are

S1	S2	S3	S4	S5	S6	S7	S8
Off	On	On	Off	Off	On	Off	On

The default DIP switch settings for the Slaves are

S1	S2	S3	S4	S5	S6	S7	S8
Off	On	On	Off	Off	On	On	Off

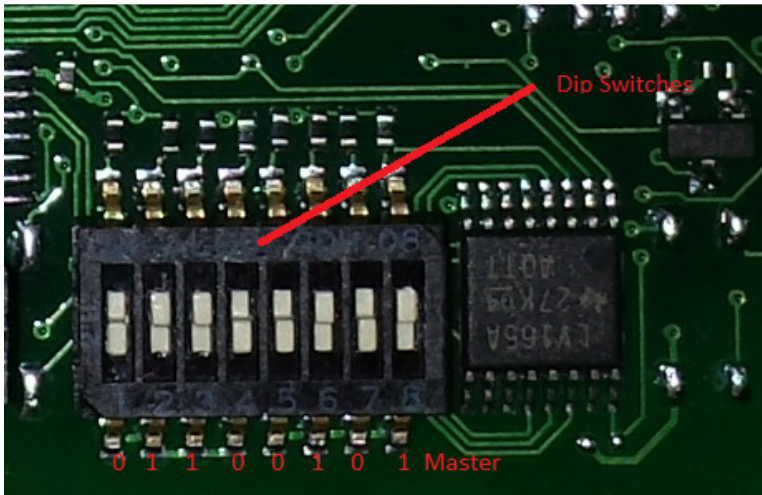

Fig 3.1

### 3.2 Radio Jumpers

There are three jumpers used to select either RS232 or RS485 communication, they must be set to RS232 .

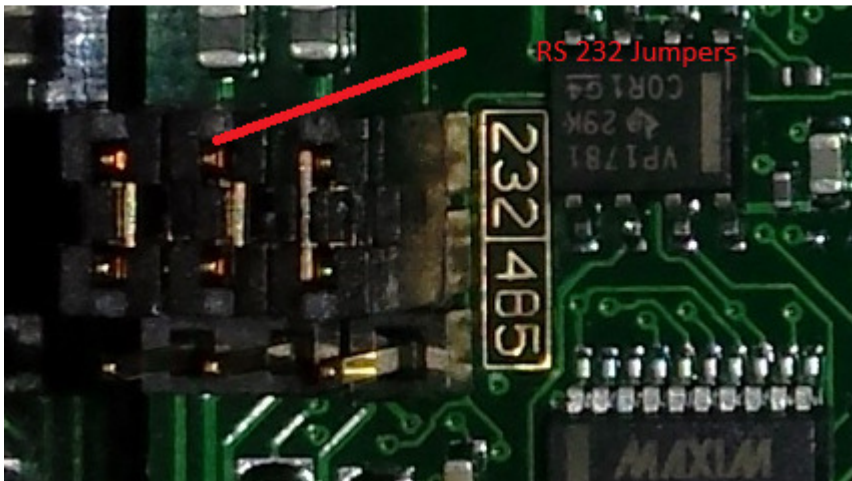

Fig 3.2

### **3.3 Pairing the devices**

1. Place your radios at least 2 meters apart and remove the circular cover on top of the radios.
2. Apply power to your radios
3. On the master push the button 3 times to put it into pairing mode. This will cause both LED's to flash red.
4. On the slave push the button 3 times, this will put the radio into pairing mode. The LED's will flash red while searching for the Master, once paired they will both be solid red for 4 seconds.
5. If you have more slaves repeat step 4 until all radios are paired.
6. When all radios are paired push the button on the master 2 times to exit pairing mode. The network will then begin to function.
7. Replace the round covers on all the radios.

## 3.4 LED Behavior

### Master Radio LEDs

		LED 1	LED 2
1	Apply power to master radio	NA	Solid amber
2	The master radio enters run mode.	Flashes Green	NA
3	Serial data begins to be transmitted between master and slave(s)	NA	Flashes Amber
	In binding mode, Only during initial Setup	Flashes red	Flashes red

### Slave Radio LEDs

		LED 1	LED 2
1	Apply power to radio	NA	Solid amber
2	Slave searching for master	Flashes red	NA
3	Master detected searches for others	Solid red	NA
4	Slave selects Master	NA	Solid amber
5	Slave attempts to synchronize with Master	NA	Solid red
6	Slave/Master synchronized	Flashes green	NA
7	Slave enters RUN mode	Solid then Flashes green	NA
8	Serial data begins to be transmitted Between master and slave(s)	NA	Flashes amber
	In binding mode, Only during initial Setup	Flashes red	Flashes red

## 4 WWSA Main Board Description

### 4.1 WWSA R1 Board

The board provides two main function, power supply and serial to USB interface.

120 VAC is fed into the board at J2 this goes into the AC to DC converter witch is regulated to +12 VDC by Q3. Optionally 12VDC can be input into J3 and it is regulated by Q1 ( J3 is not normally connected ). The +12v is additionally converted to +5VDC by DC to DC converter PS1. It provides the 5 volt components with power.

Serial RS 232 data from and to the radio is interfaced by IC1, J4 connects to TX and RX as well as +12VDC and Gnd to the radio. The Tx and Rx lines are require to be configured as a null modem ( Tx and Rx are switched between radio and WwSA board ). The data to and from IC1 is interfaced to the USB by IC2 a programmable USB to serial adapter. The USB outputs are filtered by D10. The USB connections are routed from J1 to a standard USB B connector.

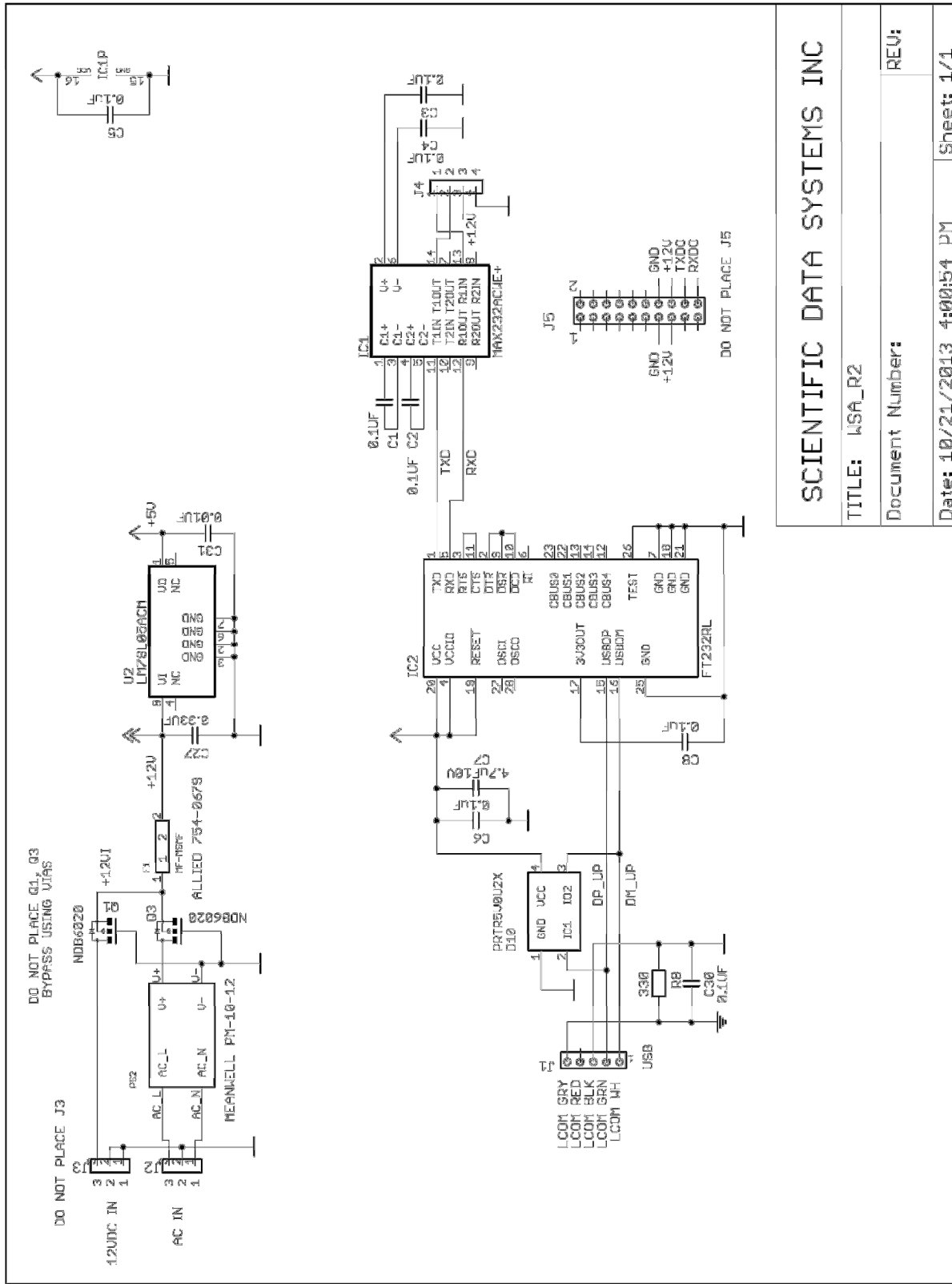

Fig 4.1 WWSA Schematic

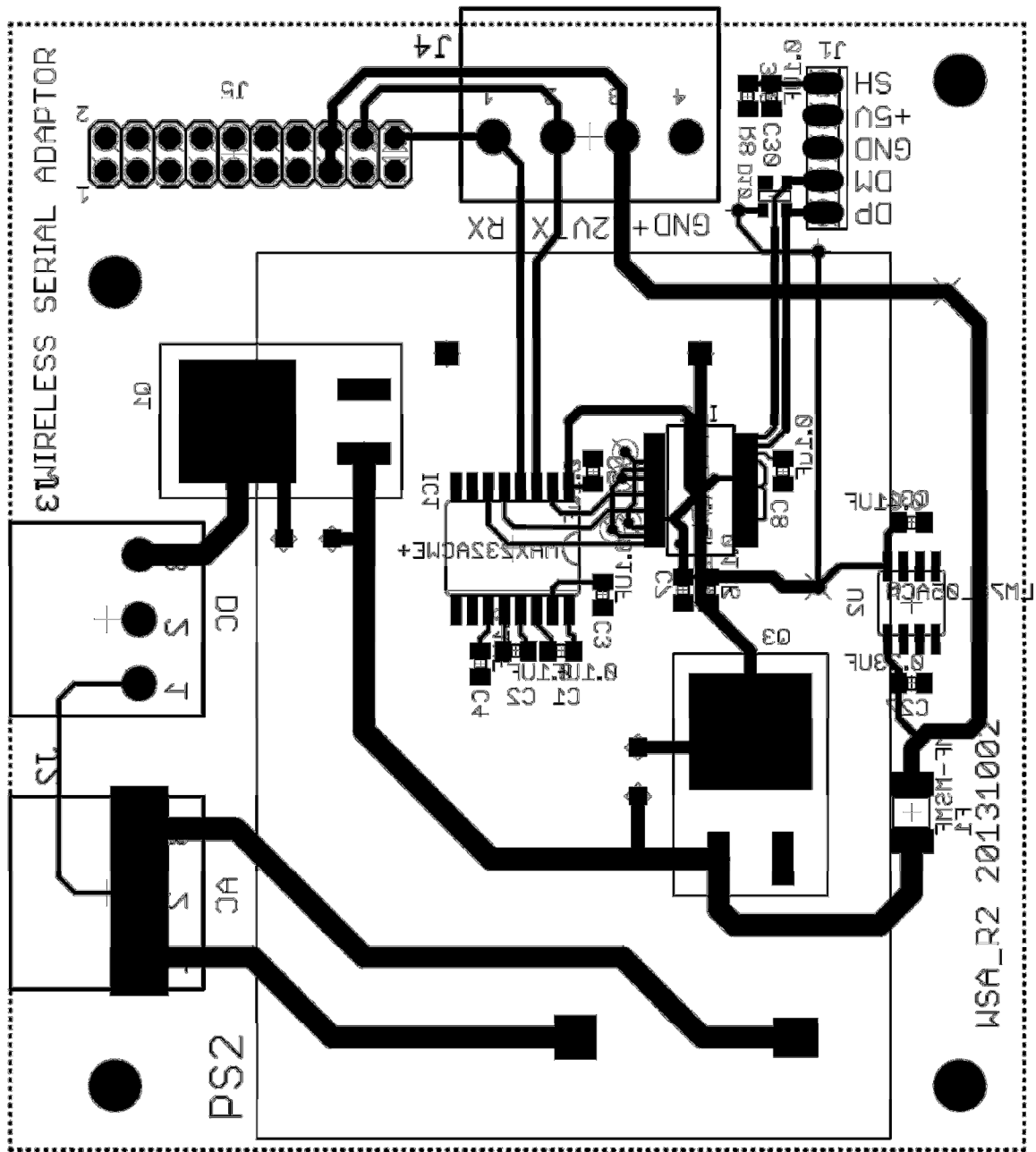
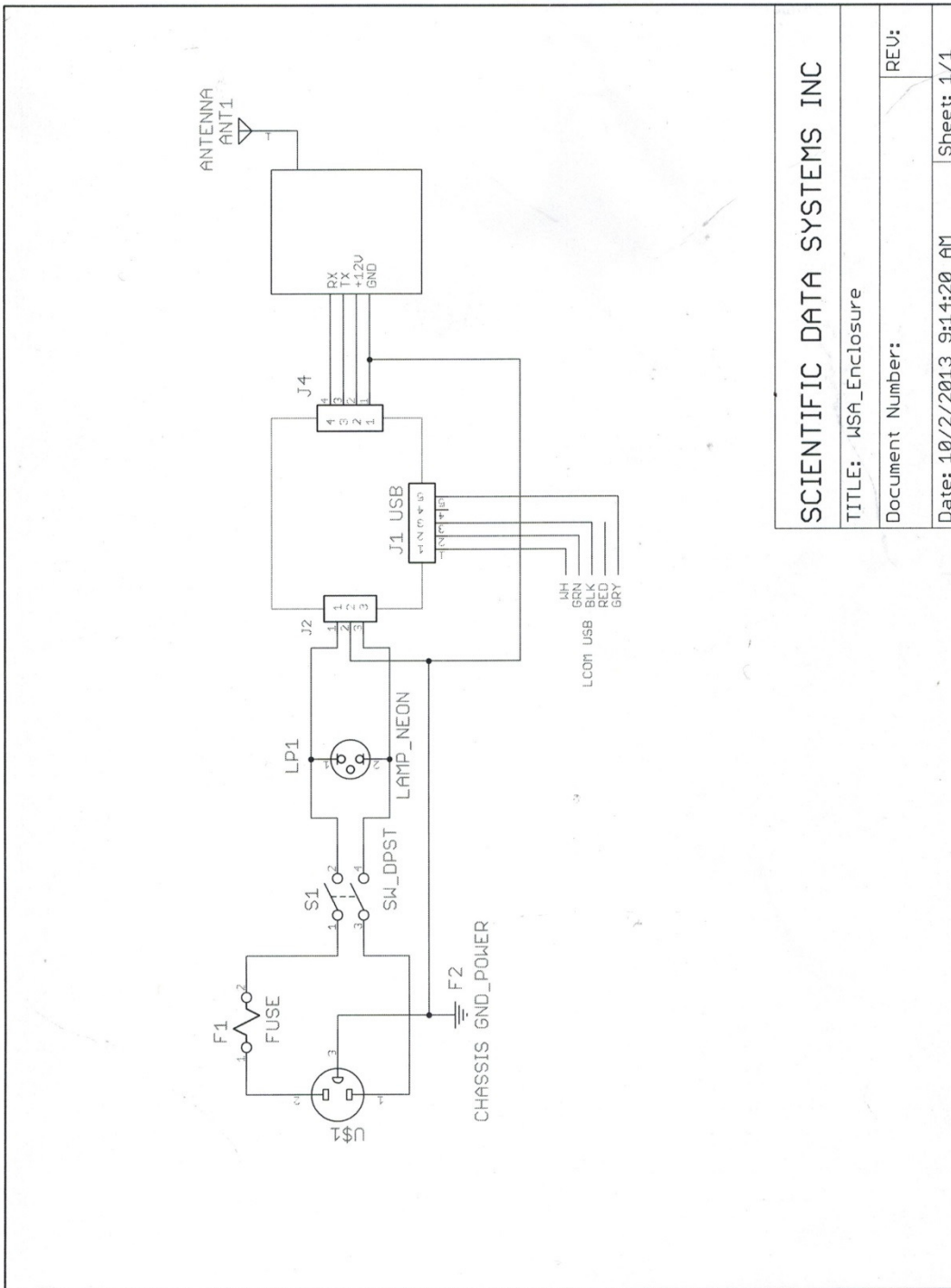

Fig 4.2 WWSA Board Layout





<b>SCIENTIFIC DATA SYSTEMS INC</b>	
TITLE: USA_Enclosure	
Document Number:	REV:
Date: 10/2/2013 9:14:20 AM	Sheet: 1/1

Fig 4.3 WWSA Wiring

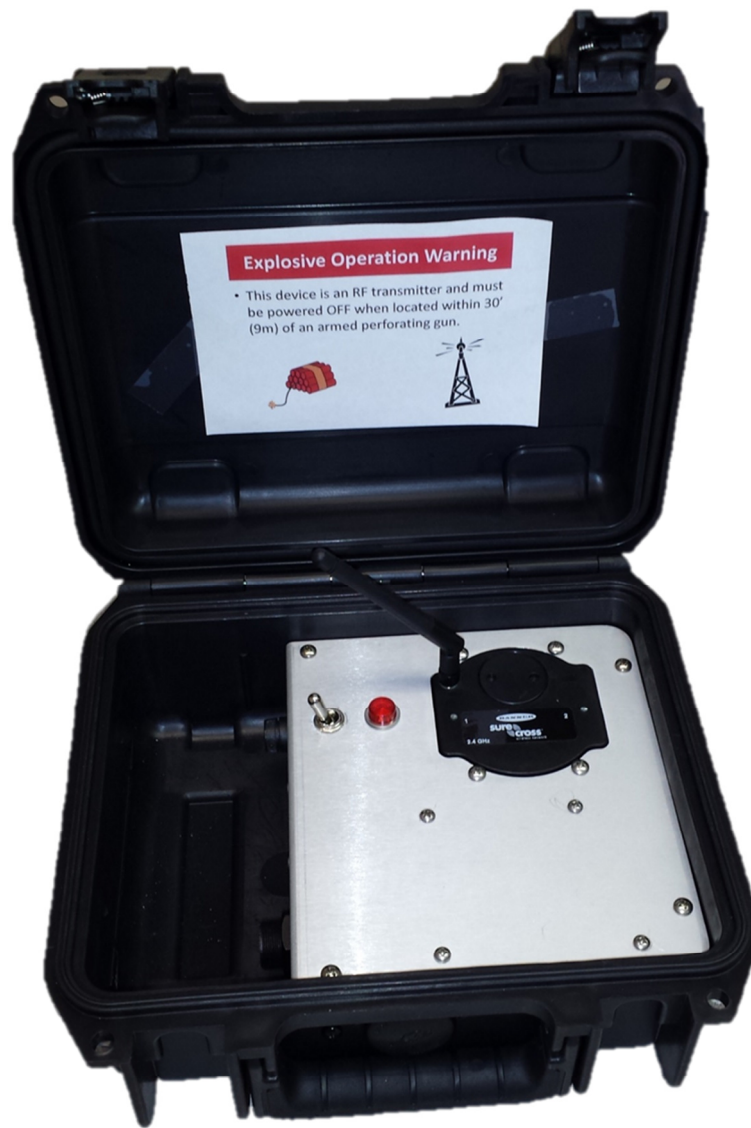

**Explosive Operation Warning**

- This device is an RF transmitter and must be powered OFF when located within 30' (9m) of an armed perforating gun.



Fig 4.4 WWSA Panel

## 5 WWSA Wire List

### Wire List for WWSA

Wireless Serial Communications Assembly  
Oct-13

#### Connector Outputs

Lamp Out			
S1-2	LP1-1	J2-1	Lamp Out
S1-4	LP1-2	J2-3	Lamp Return

S1 AC PWR			
S1-1	F1-2		
S1-2	LP1-1	J2-1	
S1-3	PS1-3		
S1-4	LP1-2	J2-3	

F1 AC Fuse			
F1-1	PS1-2		Line In
F1-2	S1-1		AC power switch

AC IN				
PS1-1	S1-3			AC Nuetral
PS1-2	F1-1			AC Line In
PS1-3	J2-2			AC Gnd

LAMP 1-Red Neon				
LP1-1	S1-2	J2-1		AC Line In
LP1-2	S1-4	J2-3		AC Nuetral

## PCB Board Connectors

PCB J1 USB In				
J1-1	WH			USB In
J1-2	GRN			USB In
J1-3	Black			USB In
J1-4	Red			USB In
J1-5	Gry			USB In

PCB J2 120v AC				
J2-1	LP1-1	S1-2		AC Line In
J2-2	PS1-3			AC GND
J2-3	LP1-2	S1-4		AC Nuetral

PCB J3 12v DC IN				
J3-1	NC			12v GND
J3-2	NC			12v GND
J3-3	NC			12v DC In

PCB J4 Serial Data				
J4-1	Radio-3			GND
J4-2	Radio-1			12v DC in
J4-3	Radio-4 Rx			Tx out
J4-4	Radio-2 Tx			Rx In

Radio J1 RS-232				
J1-1	J4-2			12v DC In
J1-2	J4-4 Rx			Rx In
J1-3	J4-1			GND
J1-4	J4-3 Tx			Tx out

## 6 Windows Driver Installation

If the computer that the Wireless Serial Communications Assembly connects to has internet access, the drivers will normally be found and downloaded when the panel is connected via USB cable. In the event that no internet access is available, a USB thumb drive is furnished with the panels containing this manual and the necessary windows drivers.

If the drivers do not install, shut the panel off and insert the USB drive. On the drive is a file named "CDM v2.08.30 WHQL Certified.EXE". Find this file and run it. Follow the directions and the drivers will be installed into the Windows operating system (except Windows 8.1). Once complete, turn the panel back on and allow the Windows to automatically install the drivers.